

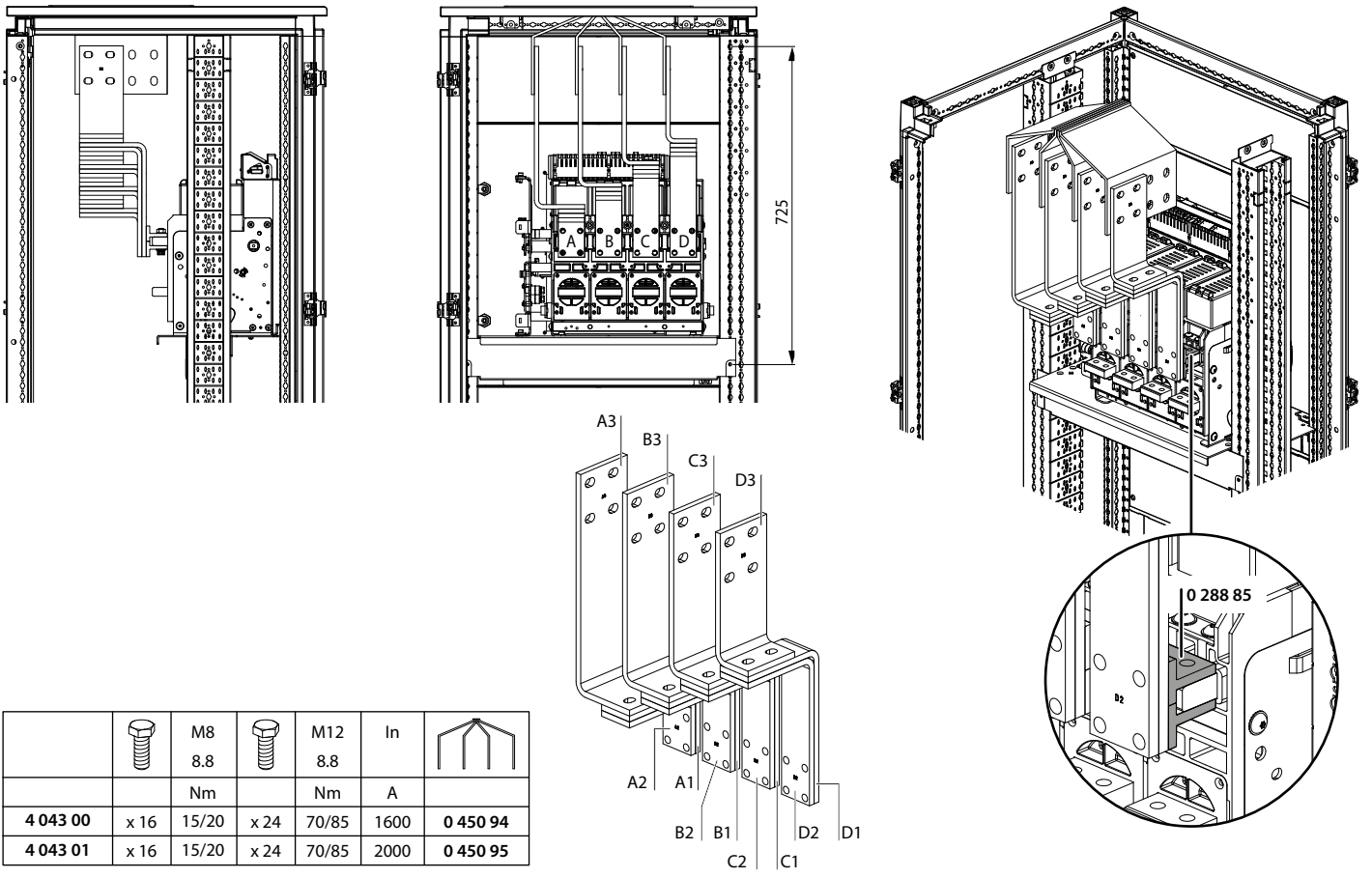







4 043 00/01

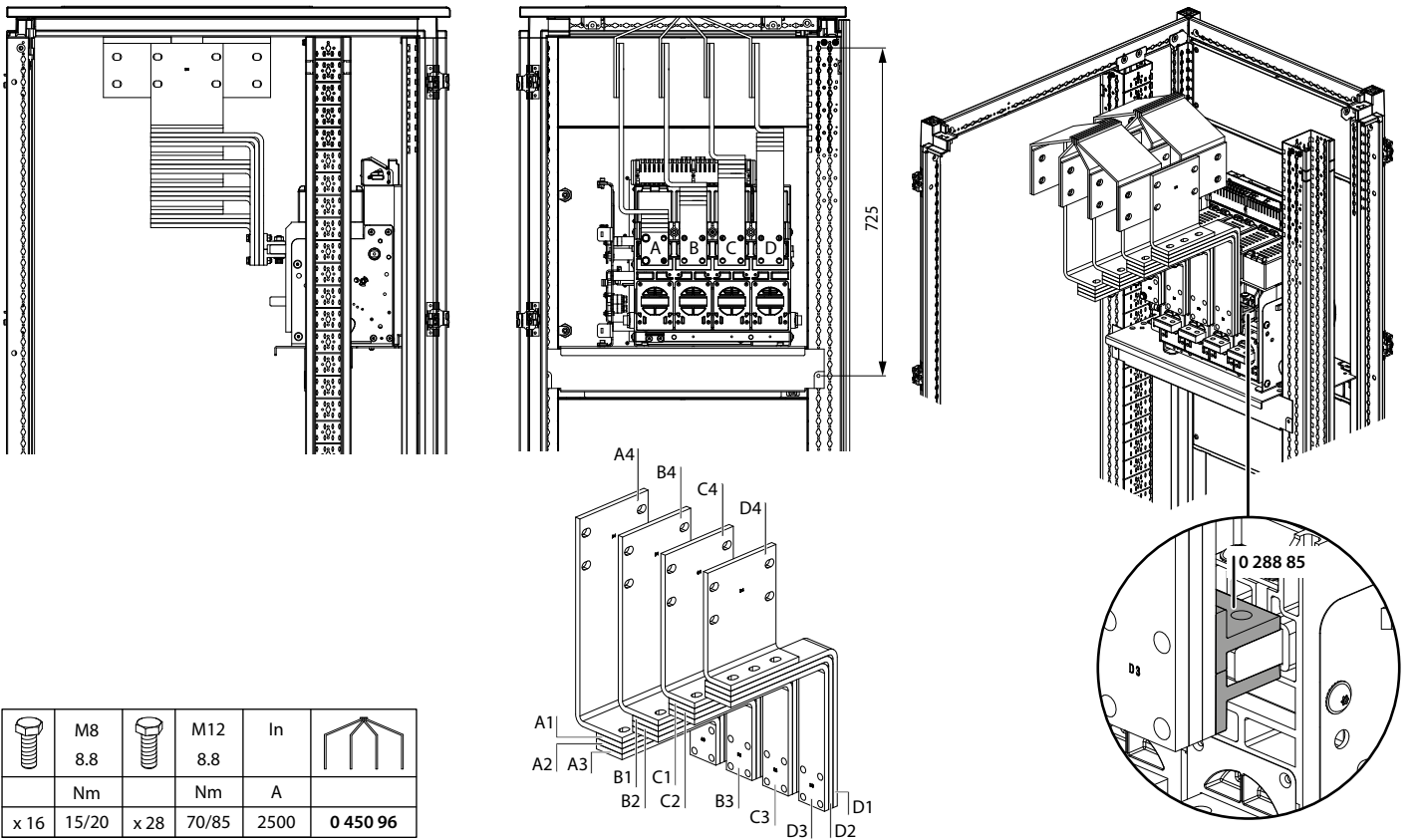

		M8		M12	In	
		8.8		8.8		
		Nm		Nm	A	
4 043 00	x 16	15/20	x 24	70/85	1600	0 450 94
4 043 01	x 16	15/20	x 24	70/85	2000	0 450 95



4 043 02



		M8		M12	In	
		8.8		8.8		
		Nm		Nm	A	
x 16	15/20		x 28	70/85	2500	0 450 96

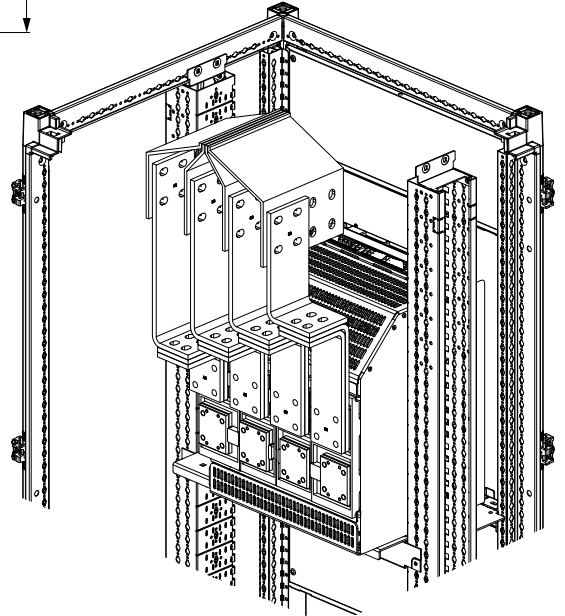
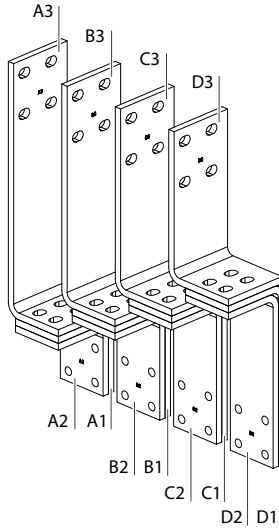
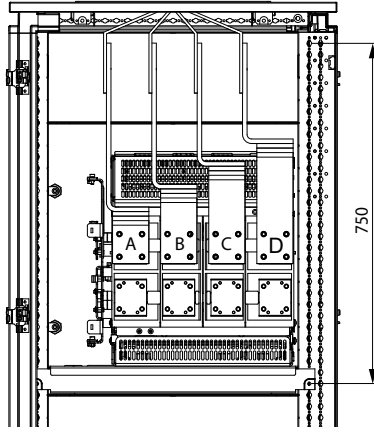
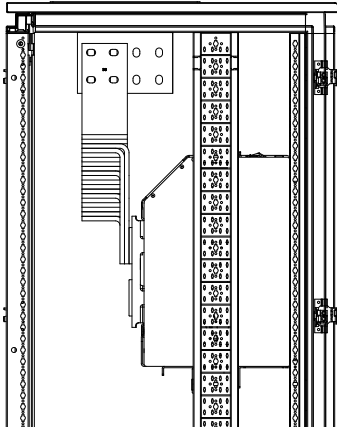

4 043 03/04



		M8		M12	In	
		Nm		Nm	A	
4 043 03	x 16	15/20	x 32	70/85	1600	0 450 94
4 043 04	x 16	15/20	x 32	70/85	2000	0 450 95

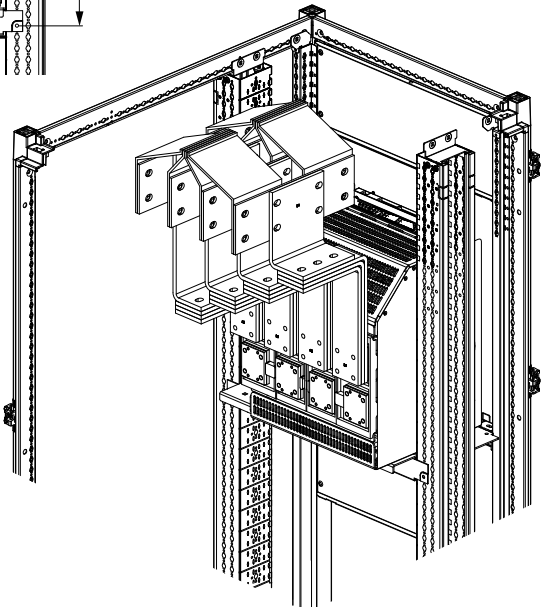
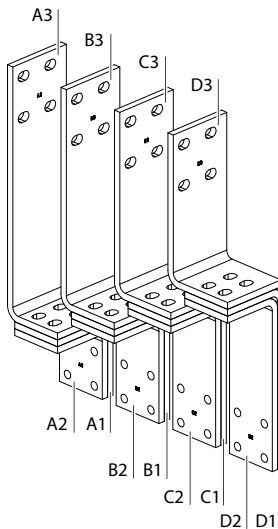
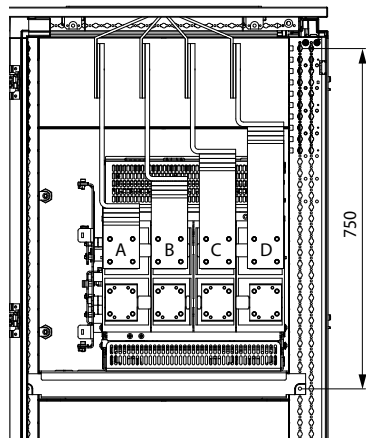
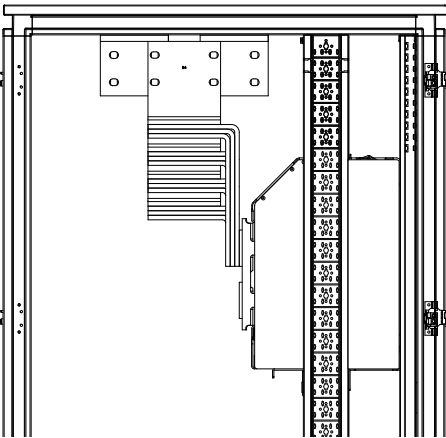

4 043 05



		M8		M12	In	
		Nm		Nm	A	
	x 16	15/20	x 28	70/85	2500	0 450 96

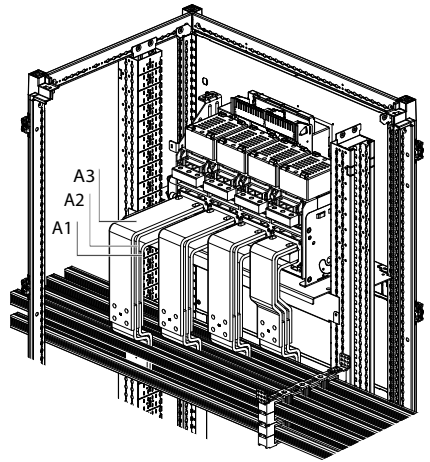
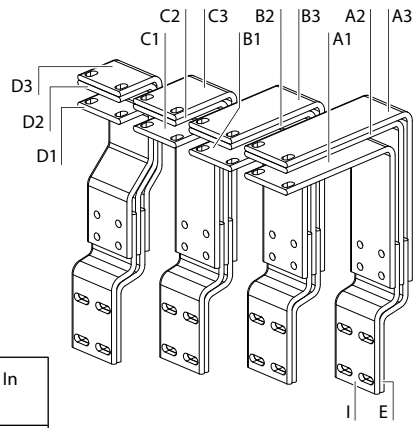
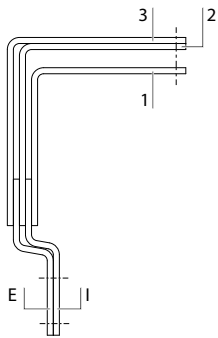
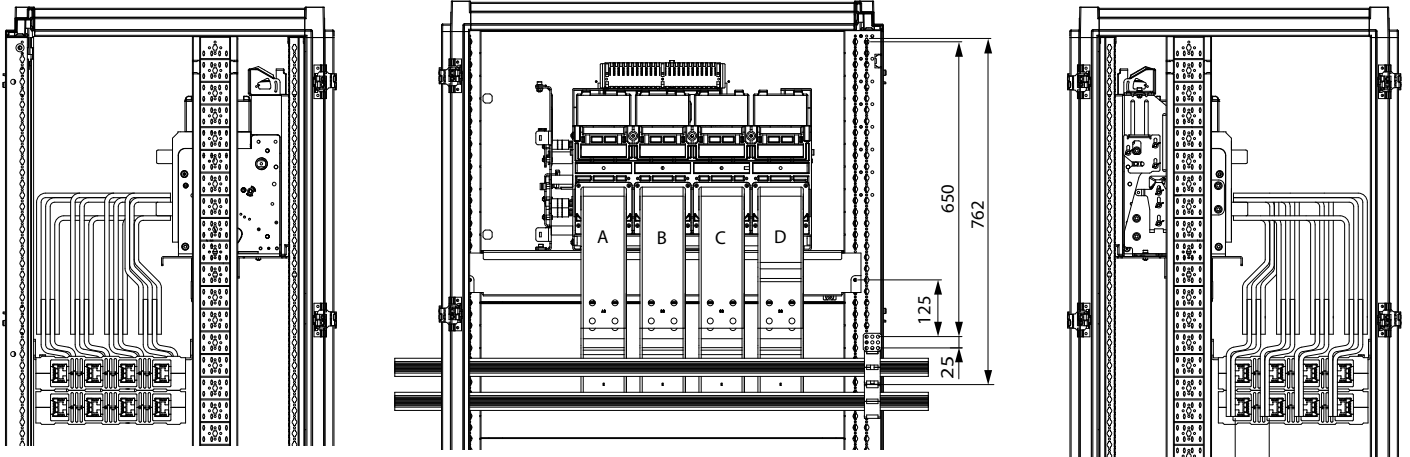

4 043 60/64/68



		M10 8.8		M8 8.8		M10 8.8	In
		Nm		Nm		Nm	A
4 043 60	x 16	50			x 24	40/50	3200
4 043 64	x 16	50	x 8	15/20	x 8	40/50	2000
4 043 68	x 4	50	x 8	15/20	x 8	40/50	1600

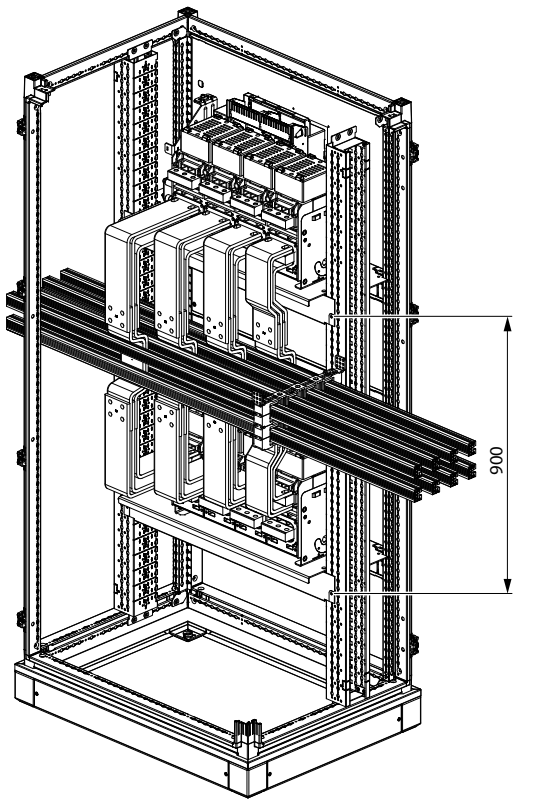
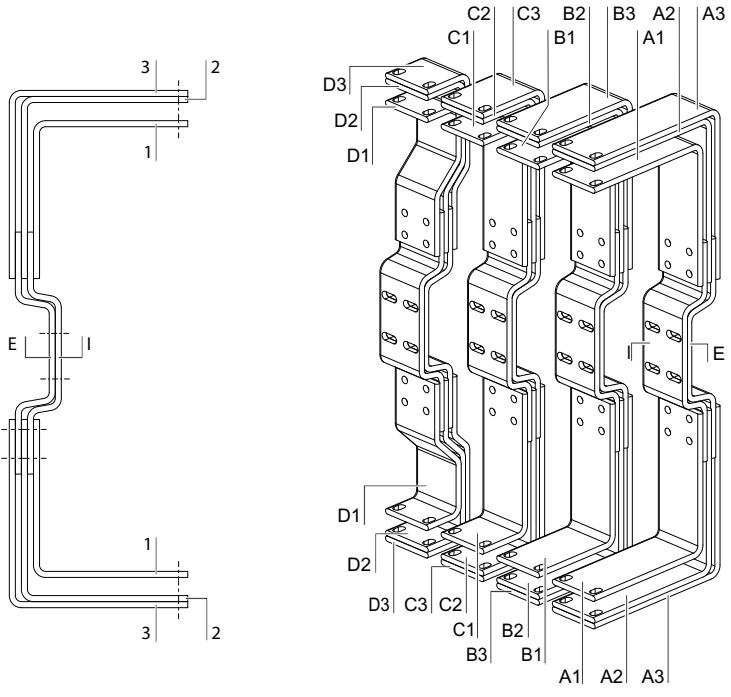

4 043 61/65/69



		M10 8.8		M8 8.8		M10 8.8	In
		Nm		Nm		Nm	A
4 043 61	x 16	50			x 48	40/50	3200
4 043 65	x 8	50	x 16	15/20	x 16	40/50	2000
4 043 69	x 4	50	x 16	15/20	x 16	40/50	1600

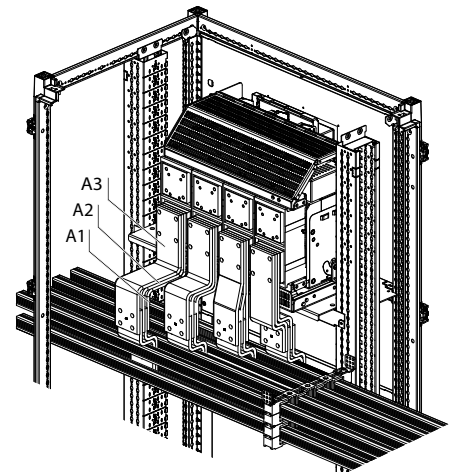
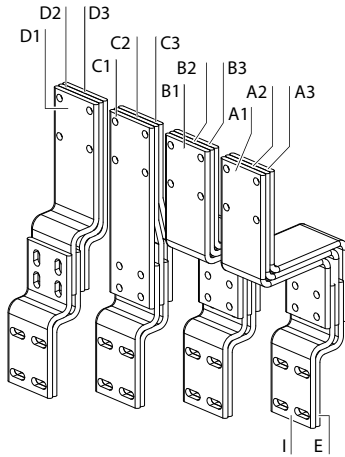
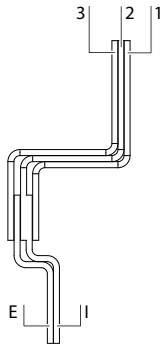
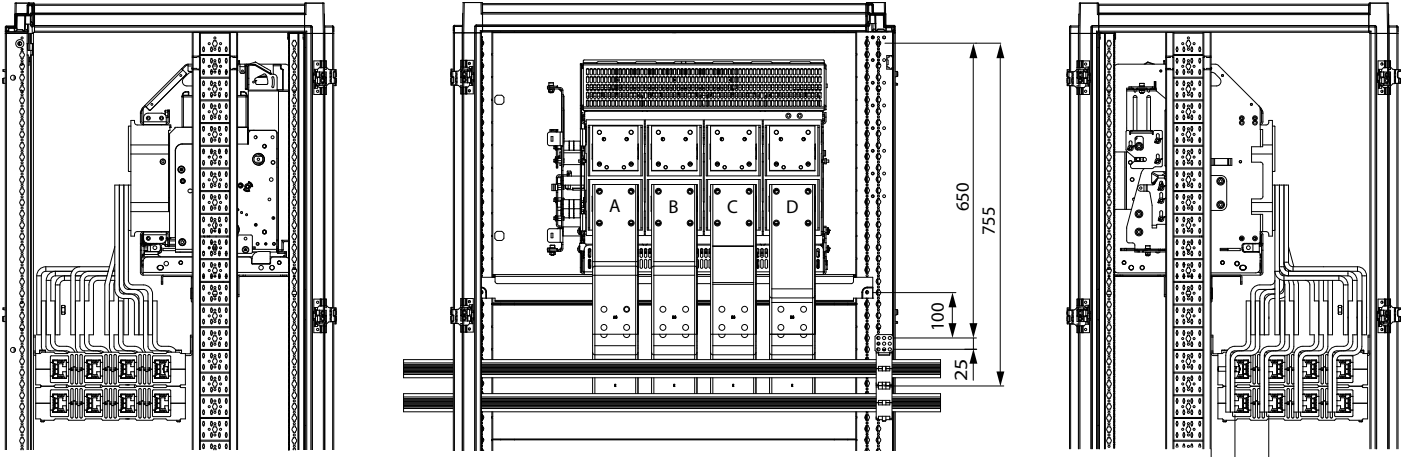

4 043 62/66/70

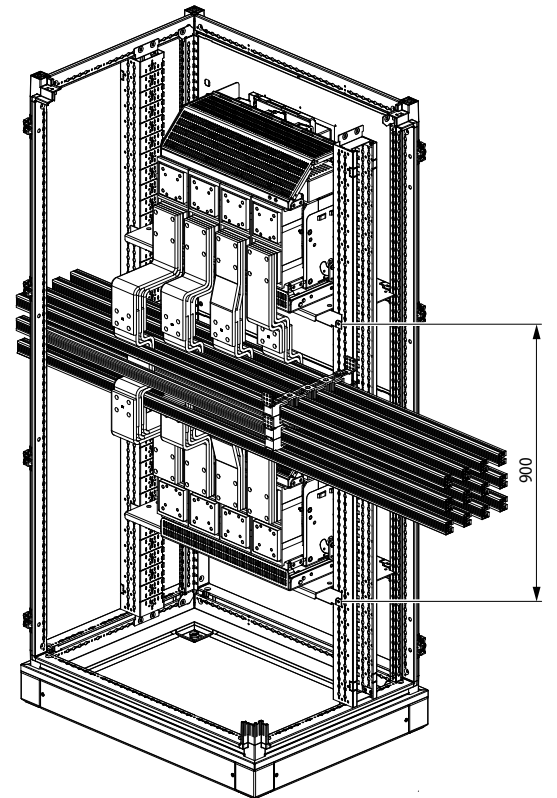
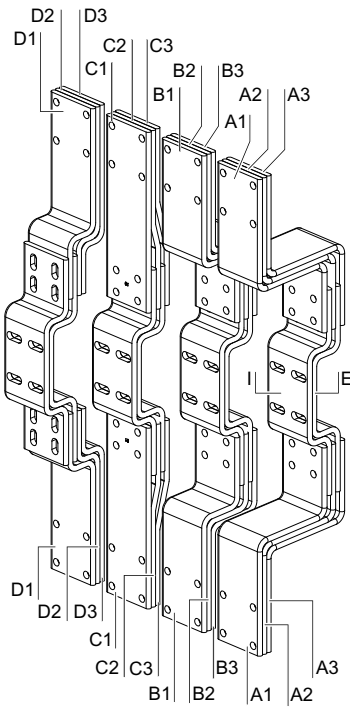
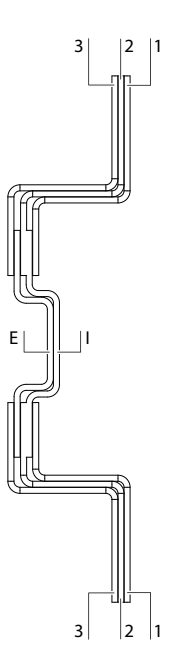

		M10 8.8		M8 8.8		M10 8.8	In
		Nm		Nm		Nm	A
4 043 62	x 16	50			x 32	40/50	3200
4 043 66	x 8	50	x 16	15/20	x 16	40/50	2500
4 043 70	x 4	50	x 16	15/20	x 16	40/50	1600

4 043 63/67/71



		M10 8.8		M8 8.8		M10 8.8	In
		Nm		Nm		Nm	A
4 043 63	x 16	50			x 64	40/50	3200
4 043 67	x 16	50	x 32	15/20	x 32	40/50	2500
4 043 71	x 8	50	x 32	15/20	x 32	40/50	1600