











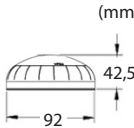







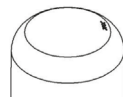

	<ul style="list-style-type: none"> • Livré avec : <ul style="list-style-type: none"> - 1 joint d'étanchéité (base) - 1 attache câble • Geleverd met : <ul style="list-style-type: none"> - 1 afdichtingsring (base) - 1 kabelhouder • Supplied with : <ul style="list-style-type: none"> - 1 seal (base) - 1 cable fastener • Mitgeliefert werden : <ul style="list-style-type: none"> - 1 dichtung (base) - 1 Kabelbinder • Entregado con : <ul style="list-style-type: none"> - 1 junto de estanqueidad (base) - 1 fijador de cable • Fornita con : <ul style="list-style-type: none"> - 1 guarnizione di tenuta (base) - 1 attacco cavo 	0 413 86	 600 cd	
		0 413 87	 1100 cd	
		0 413 88	 2500 cd	0 413 86/87/88/90/91 : 12 V - 245 mA 24 V - 130 mA 40 V - 180 mA 120 V - 65 mA 240 V - 45 mA
		0 413 89	 600 cd  880 cd  1500 cd	0 413 89 : 12 V - 100 mA 24 V - 60 mA 40 V - 175 mA 120 V - 40 mA 240 V - 30 mA
		0 413 90	 5 cd	IP 44 :  + 0 413 80/75/84 IP 65 :  + 0 413 81/82/83
		0 413 91	 7 cd	IK 08

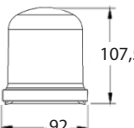
	<ul style="list-style-type: none"> • Livré avec : <ul style="list-style-type: none"> - 1 joint d'étanchéité (base) - 1 bride d'étanchéité (0 413 94 / 0 413 95) - 1 attache câble • Geleverd met : <ul style="list-style-type: none"> - 1 afdichtingsring (sokkel) - 1 afdichtingsflens (0 413 94 / 0 413 95) - 1 kabelhouder • Supplied with : <ul style="list-style-type: none"> - 1 seal (base) - 1 sealing flange (0 413 94 / 0 413 95) - 1 cable fastener • Mitgeliefert werden : <ul style="list-style-type: none"> - 1 Dichtung (Sockel) - 1 Dichtungsflansch (0 413 94 / 0 413 95) - 1 Kabelbinder • Entregado con : <ul style="list-style-type: none"> - 1 junto de estanqueidad (base) - 1 brida de estanqueidad (0 413 94 / 0 413 95) - 1 fijador de cable • Fornita con : <ul style="list-style-type: none"> - 1 guarnizione di tenuta (base) - 1 flangia di tenuta (0 413 94 / 0 413 95) - 1 attacco cavo 	0 413 92	 20 cd	
		0 413 93	 13 cd	
		0 413 94	 200 cd	0 413 92/93 : 12 V - 215 mA 24 V - 175 mA 40 V - 125 mA 120 V - 65 mA 240 V - 40 mA
		0 413 95	 150 cd	0 413 94/95 : 12 V - 210 mA 24 V - 165 mA 40 V - 155 mA 120 V - 60 mA 240 V - 40 mA
				IP 44 :  + 0 413 80/75/84 IP 65 :  + 0 413 81/82/83
				IK 08

	<p>0413 80</p>	<ul style="list-style-type: none"> • Socle faible hauteur 12-24 V AC-DC • Lage Hoogte Base 12-24 V AC-DC • Low profile base 12-24 V AC-DC • Geringe Höhe 12-24 V AC-DC • Base baja altura 12-24 V AC-DC • Base altezza bassa 12-24 V AC-DC 	<p>44 g</p>   <p>(mm)</p>
	<p>0413 81</p>	<ul style="list-style-type: none"> • Socle IP65 12-24 V AC-DC • Sokkel IP65 12-24 V AC-DC • Base IP65 12-24 V AC-DC • Sockel IP65 12-24 V AC-DC • Base IP65 12-24 V AC-DC • Base IP65 12-24 V AC-DC 	<p>63 g</p>
	<p>0413 82</p>	<ul style="list-style-type: none"> • Socle IP65 40-80 V AC-DC • Sokkel IP65 40-80 V AC-DC • Base IP65 40-80 V AC-DC • Sockel IP65 40-80 V AC-DC • Base IP65 40-80 V AC-DC • Base IP65 40-80 V AC-DC 	<p>110 g</p> 
	<p>0413 83</p>	<ul style="list-style-type: none"> • Socle IP65 120-240 V AC • Sokkel IP65 120-240 V AC • Base IP65 120-240 V AC • Sockel IP65 120-240 V AC • Base IP65 120-240 V AC • Base IP65 120-240 V AC 	<p>116 g</p>
	<p>0413 75</p>	<ul style="list-style-type: none"> • Socle en applique 12-24 V AC-DC • Wandbasis 12-24 V AC-DC • Wall base 12-24 V AC-DC • Wandboden 12-24 V AC-DC • Base de pared 12-24 V AC-DC • Base di parete 12-24 V AC-DC 	<p>155 g</p>   <p>(mm)</p>
	<p>0413 84</p>	<ul style="list-style-type: none"> • Socle en applique 120-240 V AC • Wandbasis 120-240 V AC • Wall base 120-240 V AC • Wandboden 120-240 V AC • Base de pared 120-240 V AC • Base di parete 120-240 V AC 	<p>213 g</p>

<p>0413 80 12-24 V AC-DC</p>	<p>0413 81 12-24 V AC-DC</p>	<p>0413 82 40-80 V AC-DC</p>	<p>0413 83 120-240 V AC</p>	<p>0413 75 12-24 V AC-DC</p>	<p>0413 84 120-240 V AC</p>
					

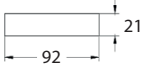
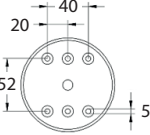

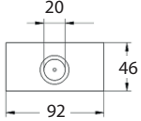
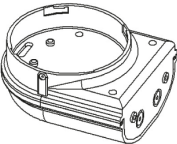
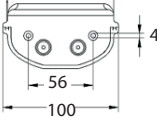
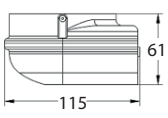
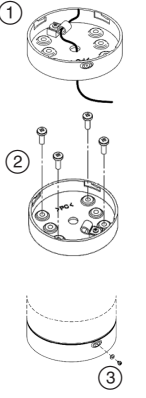
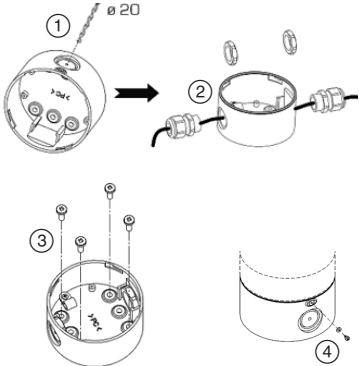
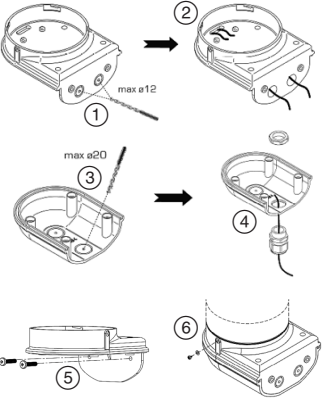
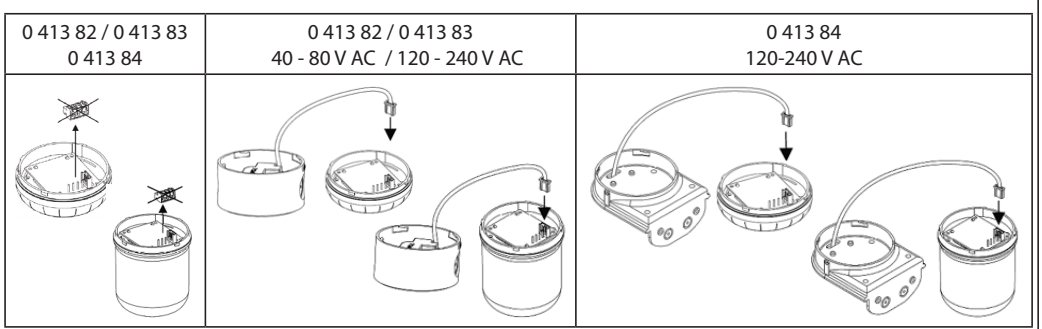
<p>0413 75 : } 0413 80 : } 12-24 V AC-DC 0413 81 : }</p> <p>0413 82 : 40-80 V AC-DC</p> <p>0413 83 : } 0413 84 : } 120-240 VAC</p>	<p>0413 86 0413 87 0413 88 0413 89 0413 90 0413 91</p>	<p>0413 94 0413 95</p> <p>< 1 s</p>	<p>0413 86 0413 87 0413 88 0413 89 0413 90 0413 91</p>	<p>0413 89</p> <p>< 1 s</p>			
<p>0413 86</p> <p>0413 87</p> <p>0413 88</p> <p>0413 89</p> <p>0413 90</p> <p>0413 91</p> <p>0413 92</p> <p>0413 93</p> <p>0413 94</p> <p>0413 95</p>							

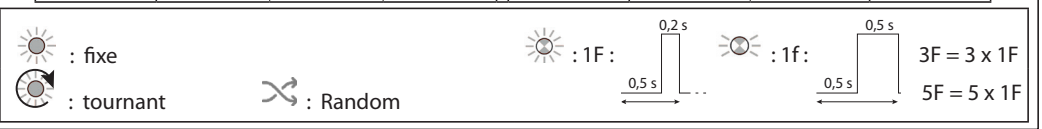

	0 413 80 12-24 V AC-DC	0 413 81 12-24 V AC-DC	0 413 82 40-80 V AC-DC	0 413 83 120-240 V AC	0 413 75 12-24 V AC-DC	0 413 84 120-240 V AC
--	---------------------------	------------------------------	------------------------------	-----------------------------	---------------------------	--------------------------

