

STP Cat 6

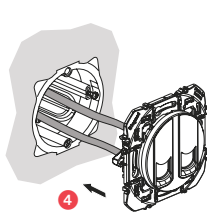

Câblage de la prise RJ45

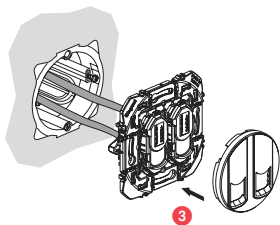
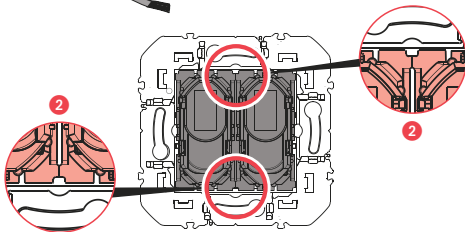
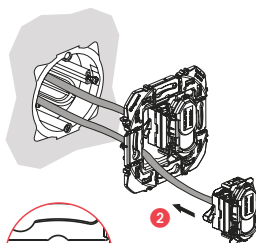
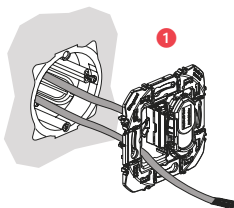
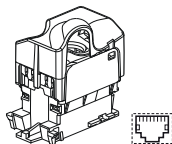
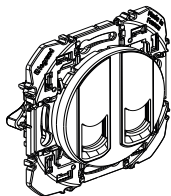
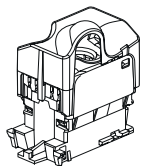

0 332 62

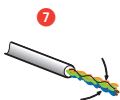
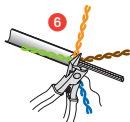
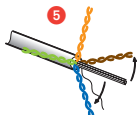
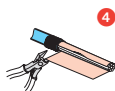
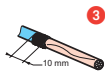
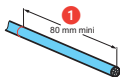

EIA 568 A



EIA 568 B

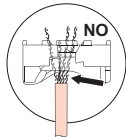
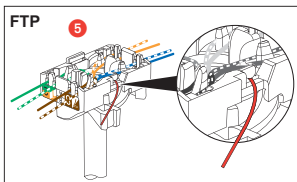
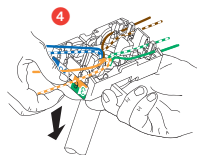
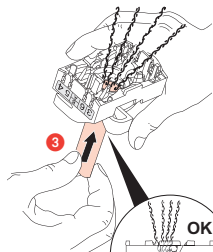
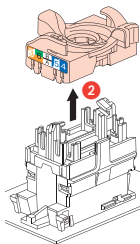
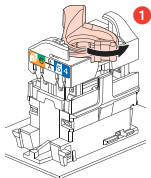
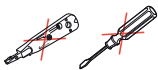
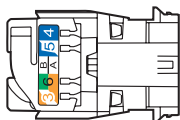
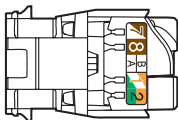

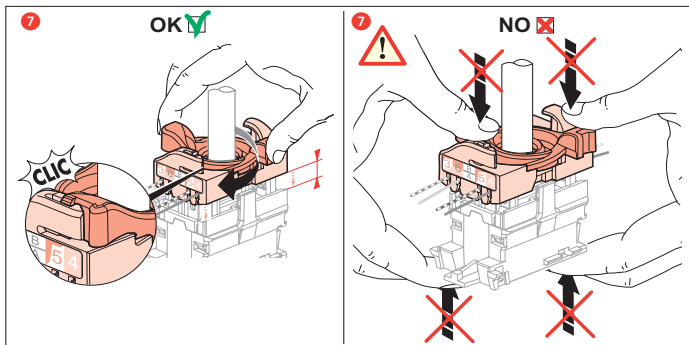
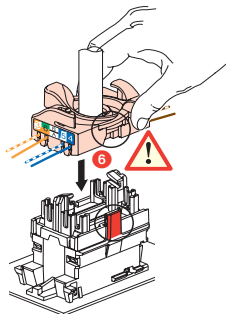

0 327 60

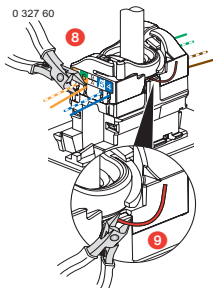

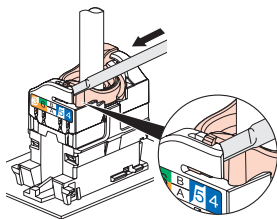

STP

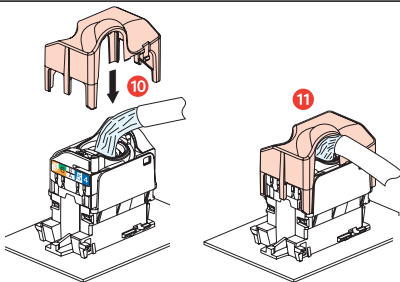

- ⚠ Respected strictement les conditions d'installation et d'utilisation.
- ⚠ Neem de installatie- en gebruiksvoorwaarden nauwgezet in acht.
- ⚠ Strictly comply with instructions for installation and use.
- ⚠ Einbau- und Gebrauchsanleitungen sind genau zu beachten.
- ⚠ Respetar estrictamente las condiciones de instalación y de utilización.
- ⚠ Rispettare scrupolosamente le condizioni d'installazione e uso.
- ⚠ Respeitar estritamente as condições de instalação e utilização.
- ⚠ Τηρήστε αυστηρά τις συθήκες εγκατάστασης και χρήσης.
- ⚠ Ścisłe przestrzegać instrukcji dotyczących instalacji i użytkowania.
- ⚠ Yerleşirme ve kullanım koşullarına titizlikle riayet ediniz.
- ⚠ Tartsa be pontosan a beszerelési és használati feltételeket.
- ⚠ Noudata asennus- ja käyttöohjeita tarkoin.
- ⚠ lakta noggrant installations- och användningsföreskrifterna.
- ⚠ Dúsledně dodržujte instalační a uživatelské podmínky.
- ⚠ Prísne dodržiavajte podmienky, za ktorých sa má prístroj inštalovať a používať.
- ⚠ Natančno upoštevajte pogoje za montažo in uporabo.
- ⚠ Installations- og anvendelsesbetingelserne skal overholdes nøje.
- ⚠ Imxi skond l-istruzzjonijiet mogħtija għall-installazzjoni u l-użu.
- ⚠ Pidage täpselt kinni paigaldus- ja kasutamistingimustes.
- ⚠ Stingri ievērot uzstādīšanas un lietošanas noteikumus.
- ⚠ Griežtai laikytis instaliavimo ir naudojimo sąlygų.
- ⚠ Installasjons- og bruksbetingelsene må nøye overholdes.
- ⚠ Følgja skal vandlega öllum reglum um uppsetningu og notkun.
- ⚠ Respectați cu strictețe condițiile de instalare și de utilizare.
- ⚠ Задължително е да се спазват условията за инсталиране и употреба.

FR BE CA LU CH
 NL BE
 GB CA IN IE US AU NZ
 DE AT LI LU CH
 ES CL CO CR MX PE US VE
 IT CH
 PT BR
 GR CY
 PL
 TR CY
 HU
 FI
 SE
 CZ
 SK
 SI
 DK
 MT
 EE
 LV
 LT
 NO
 IS
 RO
 BG

⚠ 严格遵守安裝及使用条件要求

⚠ يجب التفتيد بشروط التركيب والاستعمال بشكل تام.