

ALULED IP66/IP67

WHITE, BLUE AND RGB
LED MODULES
IN FLAT ALUMINIUM PROFILE



ALULED IP66/IP67

AluLED IP66/IP67 is ideal for outdoor protected applications under humid conditions (excluding direct UV exposure) and the slim and flat design is extremely flexible for low profile lighting design mounting.

A key advantage of AluLED is the extremely slim and flat design, which makes it suitable for illuminating complex structures or places where space is too limited to permit traditional light sources to be installed.

Typical applications

- Outdoor protected border lighting
- Outdoor protected architectural illumination
- Outdoor protected illuminated path markings
- Bathrooms and rooms with high humidity
- Refrigerated food counters

AluLED IP66/IP67

■ **ALUMINIUM PROFILE WITH HIGH QUALITY LEDs**

■ **PLUG & PLAY**

■ **SUITABLE FOR PROTECTED OUTDOOR APPLICATIONS**

■ **SLIM AND FLAT DESIGN**

■ **INTEGRATED HEAT SINK**

■ **5 YEARS WARRANTY**

Further infos see www.vossloh-schwabe.com

■ **MADE IN GERMANY**

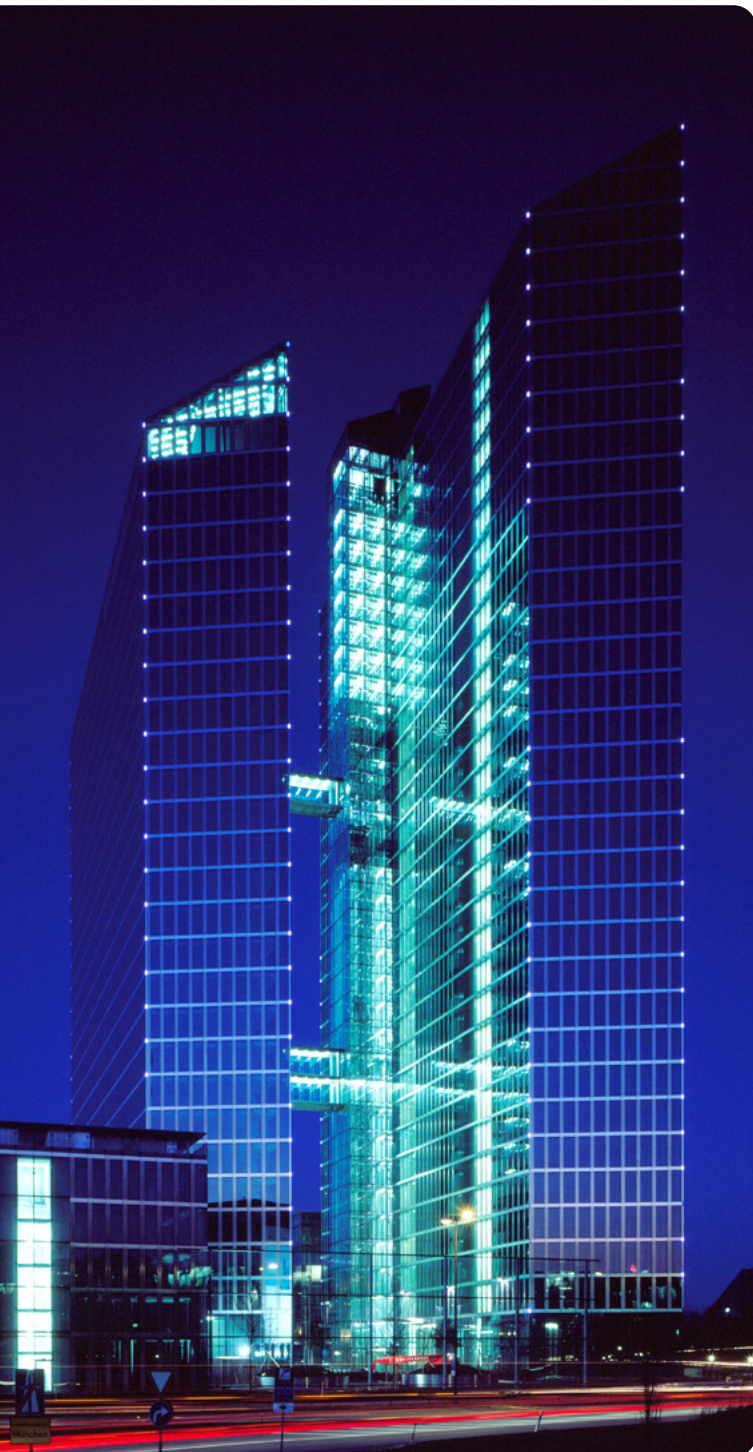

AluLED IP66/IP67

Technical notes

Voltage supply: 24 V DC
 Beam angle: 120°
 Allowed ambient temperature t_a : -30 to 85 °C
 Allowed storage temperature: -40 to 85 °C
 Degree of protection: IP66/IP67
 Maximum bridging current load: 3 A
 Lumen maintenance for white AluLED
 L70/B20: > 50,000 hrs. at $t_p/t_c < 50$ °C
 Packaging unit: 20 pcs. including mounting clips (brackets) and screws

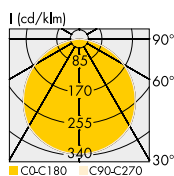

White / Blue AluLED

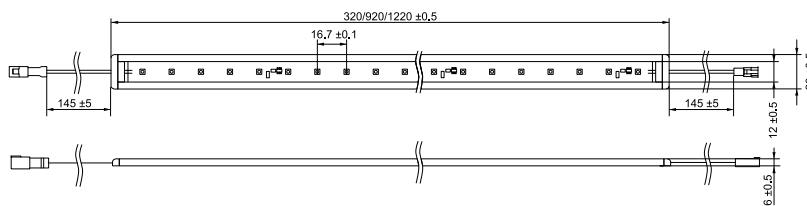

RGB AluLED

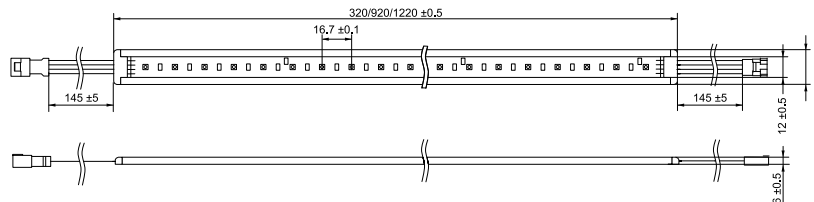

Optical characteristics

at $t_p = 50$ °C

Type	Ref. No.	Length mm	No. of LEDs	Current mA	Colour	Colour temperature (K)	Luminous flux* lm	Power W
White modules								
AluLED-320-2700-II Fully Coated	571125	320	18	140	warm white	2700 ±300	200	3.4
AluLED-520-2700-II Fully Coated	571159	520	30	235	warm white	2700 ±300	333	5.7
AluLED-920-2700-II Fully Coated	571126	920	54	420	warm white	2700 ±300	600	10.1
AluLED-1220-2700-II Fully Coated	571127	1220	72	560	warm white	2700 ±300	800	13.5
AluLED-320-3000-II Fully Coated	561698	320	18	140	warm white	3000 ±300	240	3.4
AluLED-520-3000-II Fully Coated	571160	520	30	235	warm white	3000 ±300	400	5.7
AluLED-920-3000-II Fully Coated	561699	920	54	420	warm white	3000 ±300	720	10.1
AluLED-1220-3000-II Fully Coated	561700	1220	72	560	warm white	3000 ±300	960	13.5
AluLED-320-4000-II Fully Coated	571136	320	18	140	cool white	4000 ±300	300	3.4
AluLED-520-4000-II Fully Coated	571161	520	30	235	cool white	4000 ±300	500	5.7
AluLED-920-4000-II Fully Coated	571137	920	54	420	cool white	4000 ±300	900	10,1
AluLED-1220-4000-II Fully Coated	571138	1220	72	560	cool white	4000 ±300	1200	13,5
AluLED-320-6000-II Fully Coated	571115	320	18	140	cool white	6000 ±300	280	3.4
AluLED-520-6000-II Fully Coated	571162	520	30	235	cool white	6000 ±300	467	5.7
AluLED-920-6000-II Fully Coated	571116	920	54	420	cool white	6000 ±300	840	10.1
AluLED-1220-6000-II Fully Coated	571117	1220	72	560	cool white	6000 ±300	1120	13.5

* Production tolerance of luminous flux: ± 10%

Type	Ref. No.	Length mm	No. of LEDs	Total current mA	Luminous flux (lm)			Dom. wavelength (nm)			Total power W
					red	green	blue	red	green	blue	
RGB modules											
AluLED-320-RGB-II Fully Coated	571130	320	18	140	25	75	15	620-630	520-535	465-475	3.4
AluLED-920-RGB-II Fully Coated	571131	920	54	420	75	225	45	620-630	520-535	465-475	10.1
AluLED-1220-RGB-II Fully Coated	571132	1220	72	560	100	300	60	620-630	520-535	465-475	13.5
Blue modules											
AluLED-1220-BLUE-II Fully Coated	571120	1220	72	560	-	-	240	-	-	465-475	13.5

The values contained in this data sheet can change due to technical innovations. Any such changes will be made without separate notification.

AluLED-II-HLO IP66/IP67

Technical notes

Voltage supply: 24 V DC \pm 3%
 Beam angle: 120°
 Allowed ambient temperature t_a : -20 to 65 °C
 Allowed storage temperature: -40 to 85 °C
 Colour accuracy: 3 SDCM
 Colour rendering index CRI R_a : 80
 ESD protection: up to 2 kV
 Degree of protection: IP66/IP67
 Maximum bridging current load: 3 A
 Lumen maintenance for white AluLED
 L90/B10: > 50,000 hrs. at $t_p/t_c = 65$ °C
 L70/B10: > 50,000 hrs. at $t_p/t_c = 80$ °C
 Packaging unit: 20 pcs. including
 mounting clips (brackets) and screws

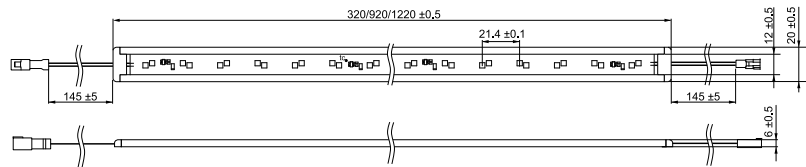
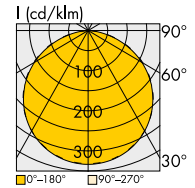

Optical characteristics

at $t_p = 50$ °C

Type	Ref. No.	Length mm	No. of LEDs	Current (mA)		Colour	Colour temperature (K)	Luminous flux* lm	Power (W)		Cover
				25 °C	50 °C				25 °C	50 °C	
AluLED-320-3000-II-HLO-IP67	571356	320	28	292	262	warm white	3000	603	7	6.3	Diffuse
AluLED-920-3000-II-HLO-IP67	571357	920	84	876	786	warm white	3000	1809	21	18.9	Diffuse
AluLED-1220-3000-II-HLO-IP67	571358	1220	112	1168	1048	warm white	3000	2412	28	25.2	Diffuse
AluLED-320-4000-II-HLO-IP67	571350	320	28	292	262	neutral white	4000	678	7	6.3	Diffuse
AluLED-920-4000-II-HLO-IP67	571352	920	84	876	786	neutral white	4000	2034	21	18.9	Diffuse
AluLED-1220-4000-II-HLO-IP67	571353	1220	112	1168	1048	neutral white	4000	2712	28	25.2	Diffuse

* Production tolerance for luminous flux: \pm 10%

The values contained in this data sheet can change due to technical innovations. Any such changes will be made without separate notification.

AluLED IP66/IP67 Tuneable White (TW)

Technical notes

Colour dynamic from 3000 K to 6000 K
 Voltage supply: 24 V DC \pm 3%
 Beam angle: 120°
 Allowed ambient temperature t_a : -20 to 65 °C
 Allowed storage temperature: -40 to 85 °C
 Degree of protection: IP66/IP67
 Maximum bridging current load: 3 A
 Leads: White: + 24 V DC (CA)
 Red: not connected
 Green: – warm white (3000 K)
 Blue: – cool white (6000 K)

Lumen maintenance

L90/B10: > 50,000 hrs. at $t_p/t_c = < 65$ °C
 L70/B10: > 50,000 hrs. at $t_p/t_c = < 80$ °C

Packaging unit: 20 pcs. including
 mounting clips (brackets) and screws

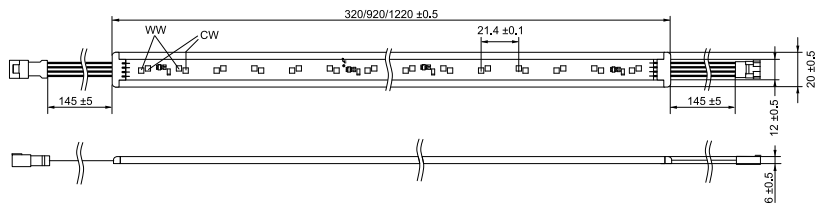
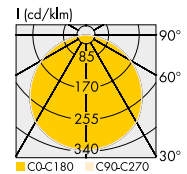

Electrical characteristics

at $t_p = 50$ °C; per channel

Type	Ref. No.	Length mm	No. of LEDs per channel	Typ. current (mA)		Typ. power (W)	
				at $t_p 25$ °C	at $t_p 50$ °C	at $t_p 25$ °C	at $t_p 50$ °C
AluLED IP66/67 TW							
AluLED-320-3000/6000	571170	320	14	143	131	3.4	3.1
AluLED-920-3000/6000	571171	920	42	429	393	10.2	9.3
AluLED-1220-3000/6000	571172	1220	56	572	524	13.6	12.4

Optical characteristics

at $t_p = 50$ °C

Type	Ref. No.	Colour temperature (K) and typ. luminous flux* (lm)						Typ. CRI R_a
		both channels 100%		only warm white 100%		only cool white 100%		
		K	lm	K	lm	K	lm	
AluLED IP66/67 TW								
AluLED-320-3000/6000	571170	4000	616	3000	285	6000	338	> 80
AluLED-920-3000/6000	571171	4000	1848	3000	855	6000	1014	> 80
AluLED-1220-3000/6000	571172	4000	2464	3000	1140	6000	1352	> 80

* Production tolerance of luminous flux: \pm 10%

The values contained in this data sheet can change due to technical innovations. Any such changes will be made without separate notification.

AluLED IP66/IP67

EasyConnect Cable for AluLED

Max. permissible current: 3 A

Number of strands: 2/4

(Strand diameter: 0.35 mm²/22 AWG)

For monochrome modules with 2 strands

Ref. No.: 543426 25 cm, feed-in connector

Ref. No.: 543427 50 cm, PCB to PCB connector

For RGB modules with 4 strands

Ref. No.: 543428 25 cm, feed-in connector

Ref. No.: 543429 50 cm, PCB to PCB connector

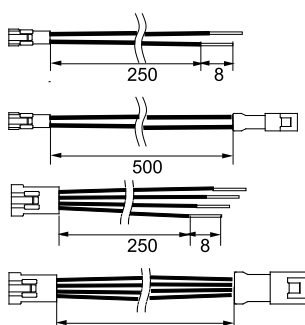

Shrink caps

For sealing exposed connection wires

(Strand diameter: 0.35 mm²/22 AWG)

Adhesive coating on the inside

Ref. No.: 571150 transparent

Ref. No.: 571151 black

Magnetic holder for AluLED

For easy fixation with springs and magnet

(scope of supply: 2 pcs.)

Ref. No.: 143208



Safety Instructions

- AluLED products may only be installed and commissioned by authorised and qualified staff.
- Please read these instructions carefully prior to installing and commissioning the system since this is the only way to ensure safe and proper system operation. You are recommended to keep these instructions in a safe place for possible future reference.
- Any work undertaken on a device must only be performed after disconnection from the mains.
- Relevant safety and accident prevention measures must be observed.
- Products must never be improperly opened since electrical voltage poses a risk to life. Repairs must only be performed by the manufacturer.
- Connecting feeder/supply lines to external voltage, e.g. 230 V mains voltage, can destroy individual system components.

- Mounting clips (brackets) are used to attach AluLED IP66/IP67 modules to a solid, load-bearing substrate. The mounting clips must be attached to the substrate using screws. The space left between the mounting clips must ensure the module neither bends nor bows. Once properly mounted, the AluLED IP66/IP67 module must be firmly enclosed by the mounting clips.
- The module can be installed any way up, but vertical wall mounting could lead to the module slipping out of the clips.
- Sufficient clearance must be left to other neighbouring objects to allow for the longitudinal thermal expansion of the module.
- Care must equally be taken to ensure any collecting water (e.g. rain) can drain.
- To prevent corrosion, contact with base metals, aggressive fluids and gases must be avoided. Operation in environments that are chemically enriched with (aggressive) chemical substances can impair functionality and can even result in total module failure. Detailed information as well as examples of hazardous environments and chemical substances can be found in the document "Chemical Incompatibilities Affecting LEDs", published by Vossloh-Schwabe Deutschland (www.vossloh-schwabe.com).

Mounting

1. Screw the mounting clips firmly to the substrate.
2. Click module into the mounting clips.

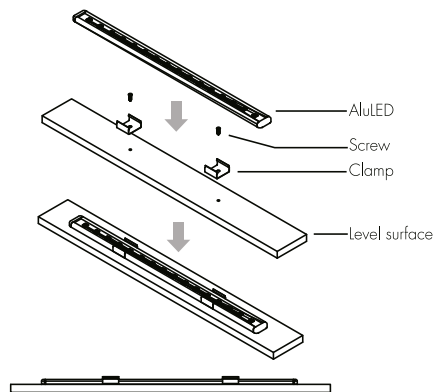

The values contained in this data sheet can change due to technical innovations. Any such changes will be made without separate notification.

AluLED IP66/IP67

Installation Instructions

1. When using several modules, the connector of a feed-out line must be attached to the connector of the following module's feed-in line.
 2. The final feed-out line must be protected against humidity and water ingress with a connector.
 3. Connect control gear's feed-in line to the control gear unit (24 V constant current driver with a constant output voltage of $24\text{ V} \pm 0.5\text{ V}$).
 4. Check the polarity of the control gear's feed-in line (red + /black -).
 5. Attach the control gear's feed-in line to the connector of the (first) AluLED IP66/IP67 module's feed-in line.
 6. Calculate the total power uptake of the connected AluLED IP66/IP67 modules and compare the value with the data supplied for the connected control gear. Should the control gear's permissible total power uptake be exceeded, the equipment needs to be replaced with an adequately rated control gear unit.
 7. Connect the control gear to the power supply in accordance with the installation instructions.
- Each AluLED IP66/IP67 module is fitted with a pre-assembled feed-in line with a connecting terminal as well as with a feed-out line with a connector for looping the supply voltage through to the next AluLED IP66/IP67 module.
 - Should this not be necessary, the spare connector must be protected against the ingress of humidity.
 - Alternatively, the connecting terminal can be removed and the exposed connecting wires sealed using shrink caps that are internally coated with adhesive (Ref. No.: 571150 (transparent) or 571151 (black)).
 - If only one such shrink cap is used to seal both connecting wires, care must be taken to ensure the wires are of differing lengths to prevent the internal metal conductors from touching one another.
 - The connecting terminals and connectors of the pre-assembled connecting leads prevent any reversal of polarity. Only the polarity of the control gear's requisite feed-in line (Ref. No.: 543426) can be reversed when connecting it to the control gear.
 - Prior to commissioning, care must be taken to ensure the polarity of the control gear's feed-in line is correct. The red cable is "+" and the black cable is "-".
 - A 24 V constant current driver with a constant output voltage ($24\text{ V} \pm 0.5\text{ V}$) must be used for control gear purposes. To ensure safe operation this 24 V constant current driver should also be fitted with protection against overvoltages, short-circuiting and over-heating.
 - The maximum 3 A current load on the voltage supply line, the control gear's feed-in line and the extension lead must not be exceeded. The resulting maximum number of AluLED IP66/IP67 modules that can be connected is additionally dependent on the maximum output current of the 24 V constant current driver with a constant output voltage as well as the voltage drop caused by the AluLED IP66/IP67 modules and their leads.

Further Information

- If the distance between the control gear and the (first) AluLED IP66/IP67 module is too great to be bridged using the feed-in lines of the control gear and the AluLED IP66/IP67 module, a VS extension lead (Ref. No.: 543427) must be used to close the gap.
- Should an extension lead additionally be used to connect AluLED IP66/IP67 modules that are farther away, the unavoidable electrical resistance of the extension lead will cause a more pronounced voltage drop, which in turn can impair the functionality of the AluLED IP66/IP67 modules. AluLED IP66/IP67 modules are designed for operation with a constant voltage of $24\text{ V} \pm 0.5\text{ V}$.

Complies to following standards

EN 62031:2008 / A1:2013 / A2:2015
LED modules for general lighting – Safety specifications

EN 60529:1991 / A1:2000 / A2:2013
Degrees of protection provided by enclosures (IP Code)

EN 60068-2-60:1996
Environmental testing – Part 2: Tests – Test Ke: Flowing mixed gas corrosion test, Method 4

EN 61547:2009
Electrostatic discharge immunity test (ESD):
4 kV direct contact discharge – 8 kV air discharge

EN ISO 9227:2012
Corrosion tests in artificial atmospheres – Salt spray tests

The values contained in this data sheet can change due to technical innovations. Any such changes will be made without separate notification.