

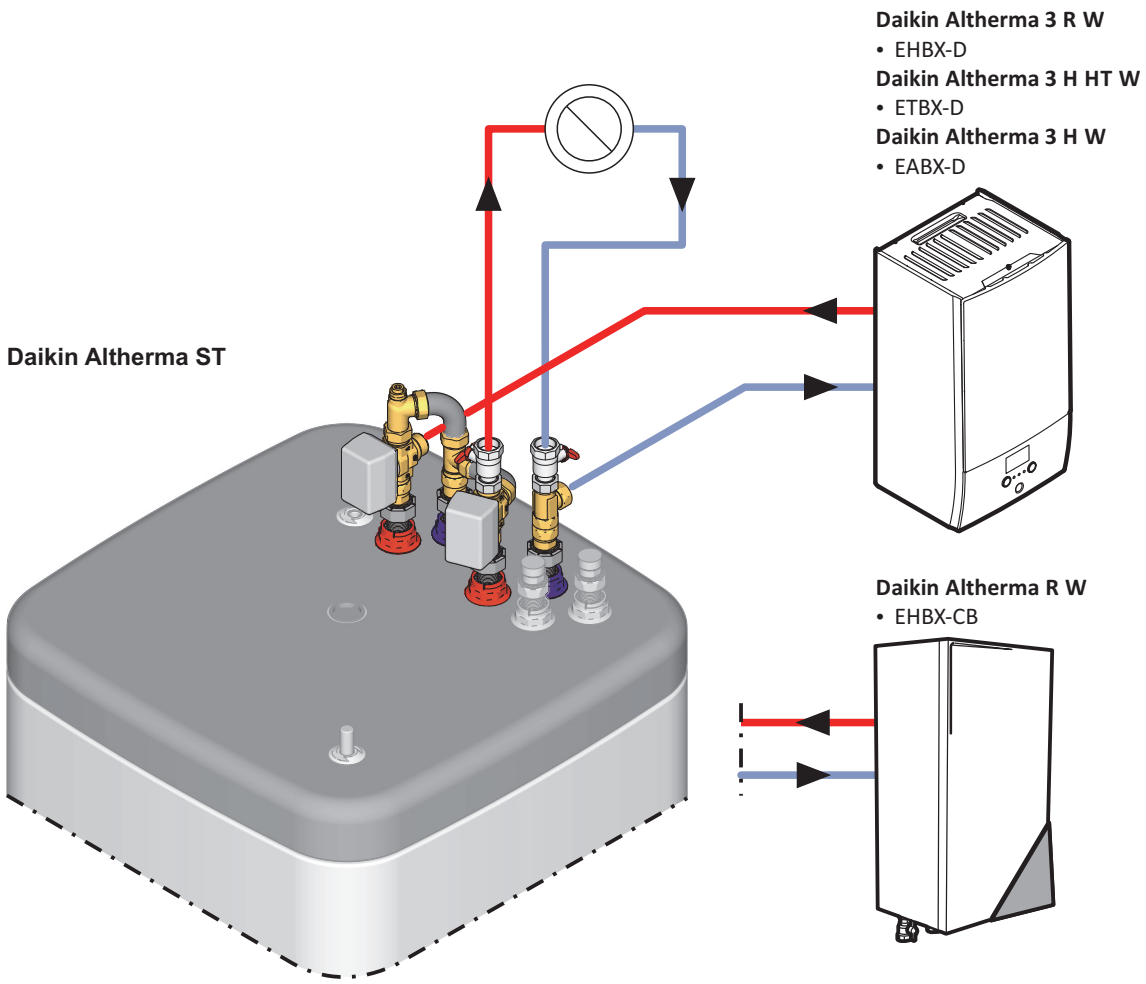

E-Pac  EKEPRHLT5X

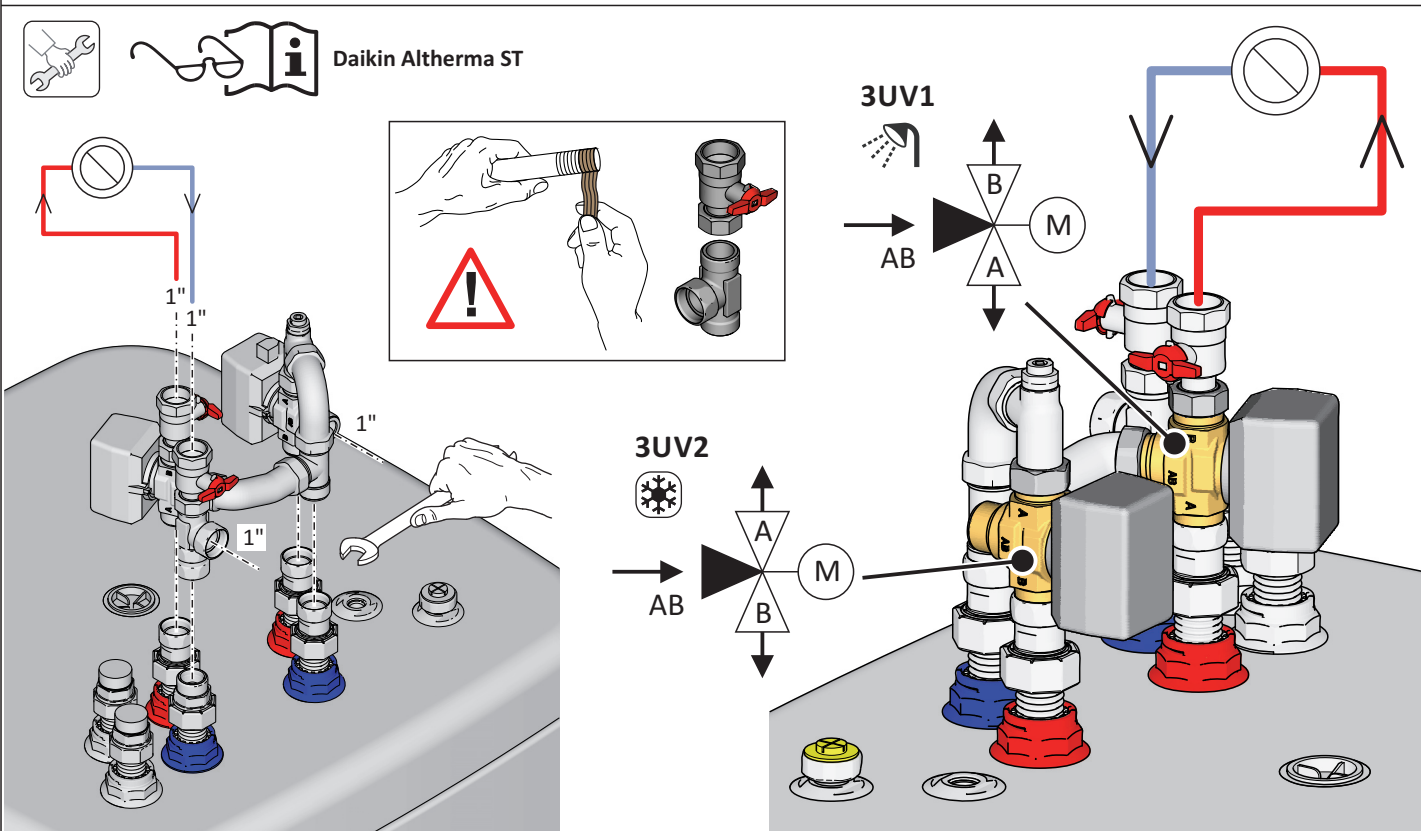

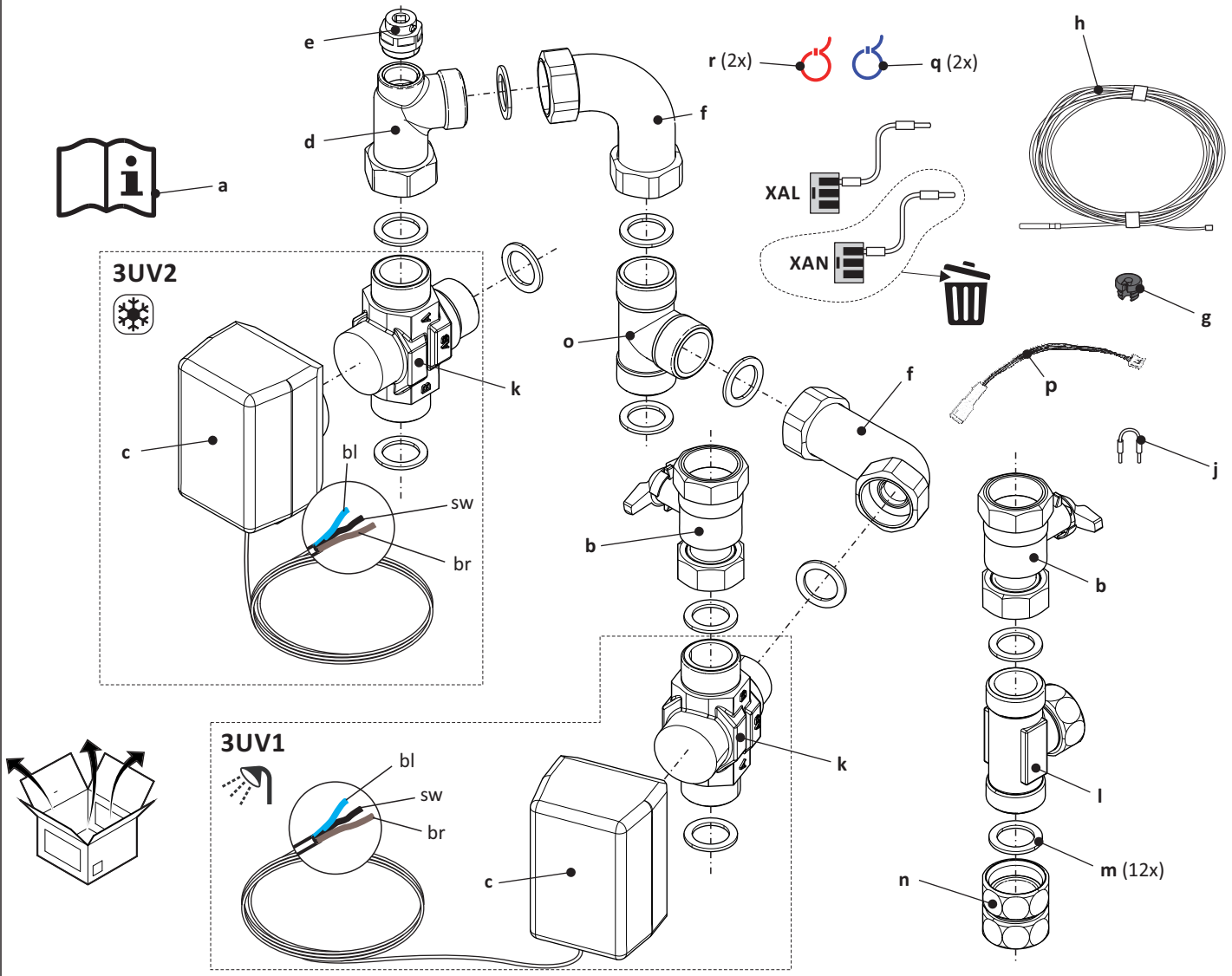

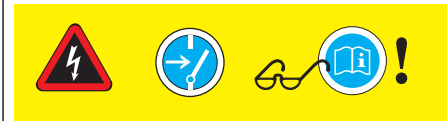
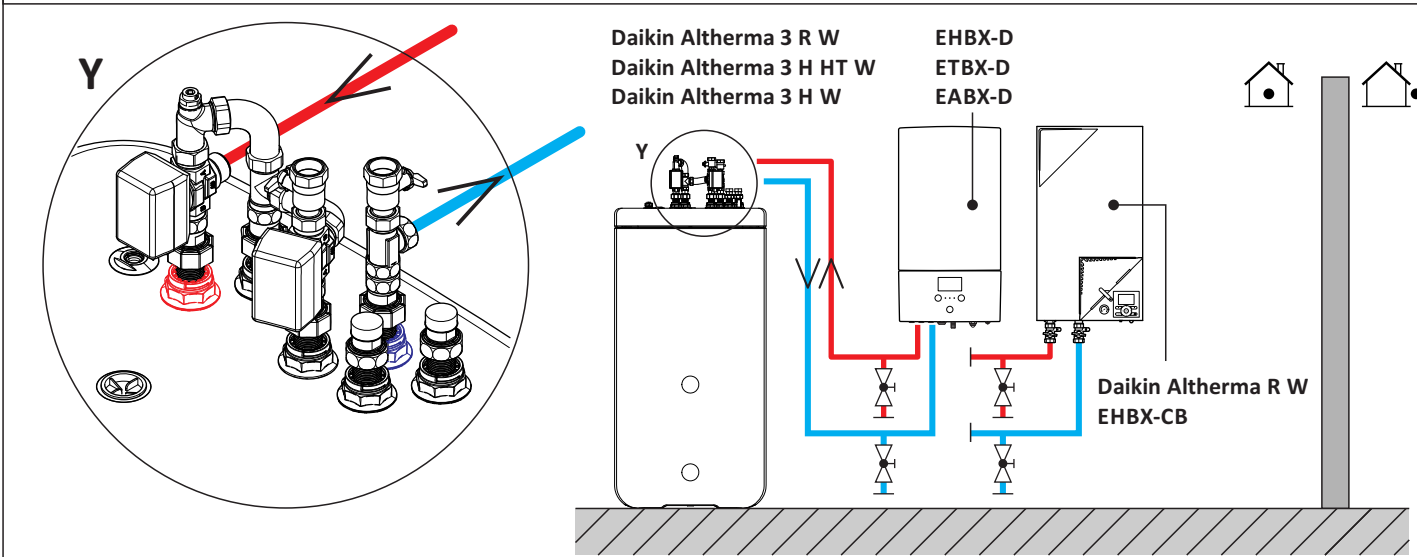
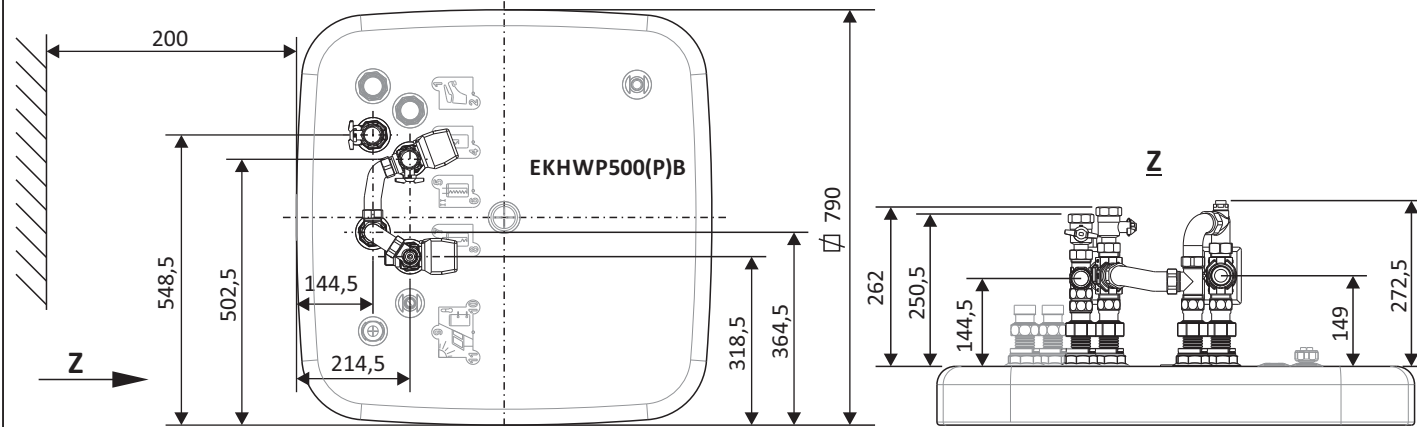

Daikin Altherma R W
Daikin Altherma 3 R W
Daikin Altherma 3 H HT W
Daikin Altherma 3 H W

Daikin Altherma ST

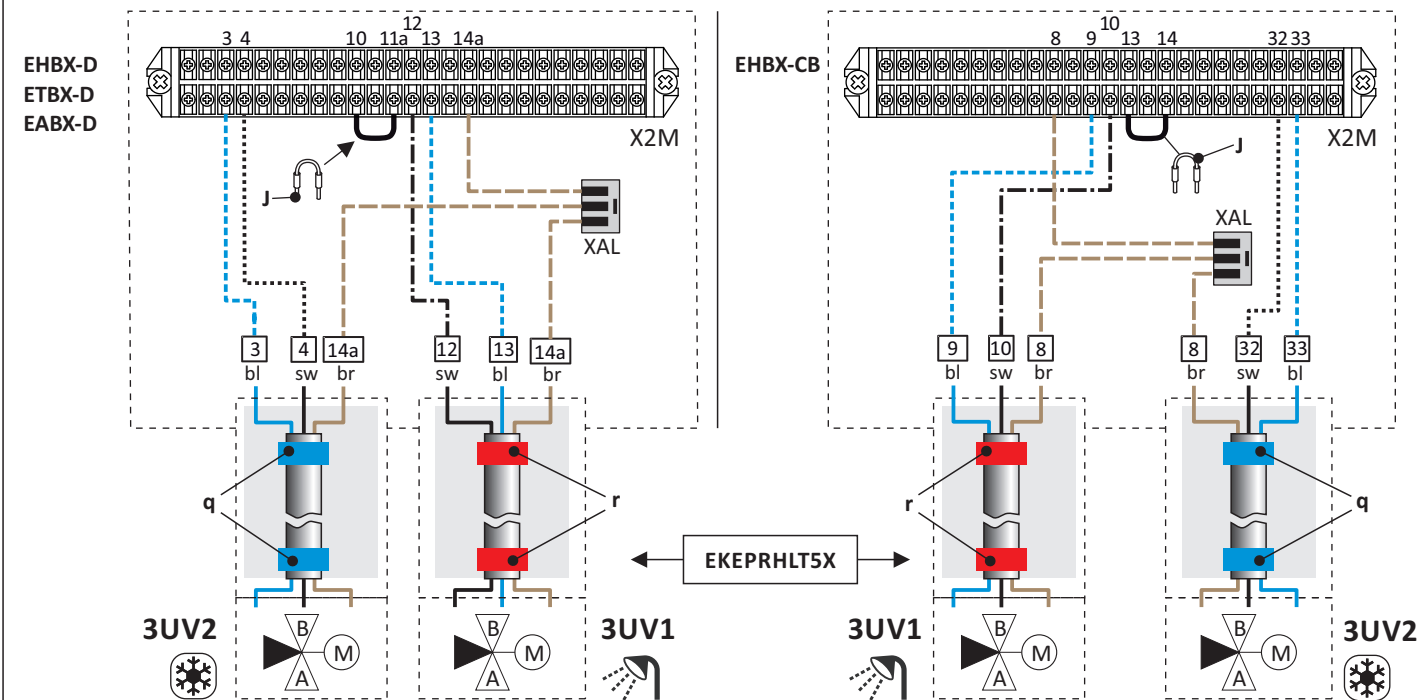

	EN	DE	NL	IT	ES	FR	PT
br	brown	braun	bruin	marrone	marrón	marron	castanho
sw	black	schwarz	zwart	nero	negro	noir	preto
bl	blue	blau	blauw	blu	azul	bleu	azul

EHBX-CB

Field code	Range, step	Default value	Change setting to
[4-05]		0	→2



Daikin Altherma 3 R W EHBX-D
 Daikin Altherma 3 H HT W ETBX-D
 Daikin Altherma 3 H W EABX-D

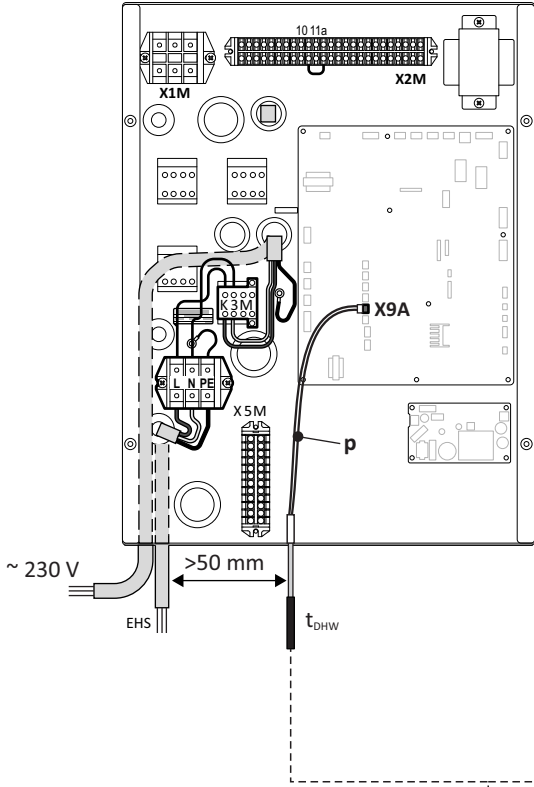

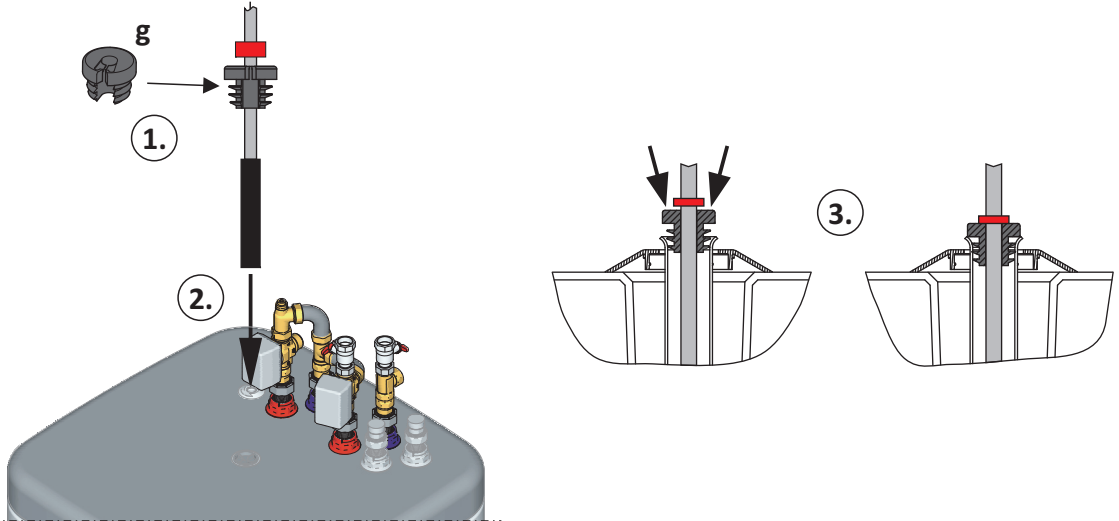
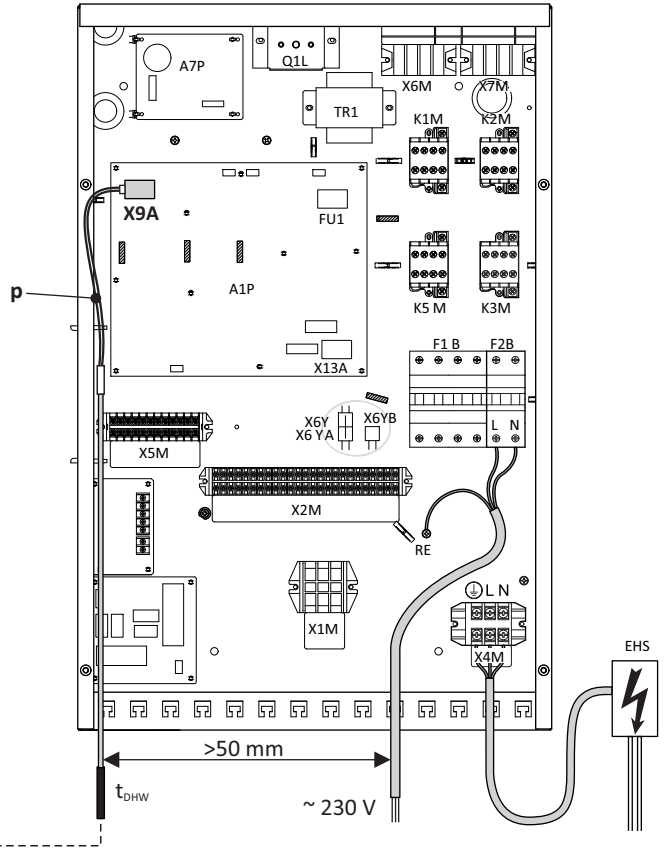

Daikin Altherma R W / EHBX-CB

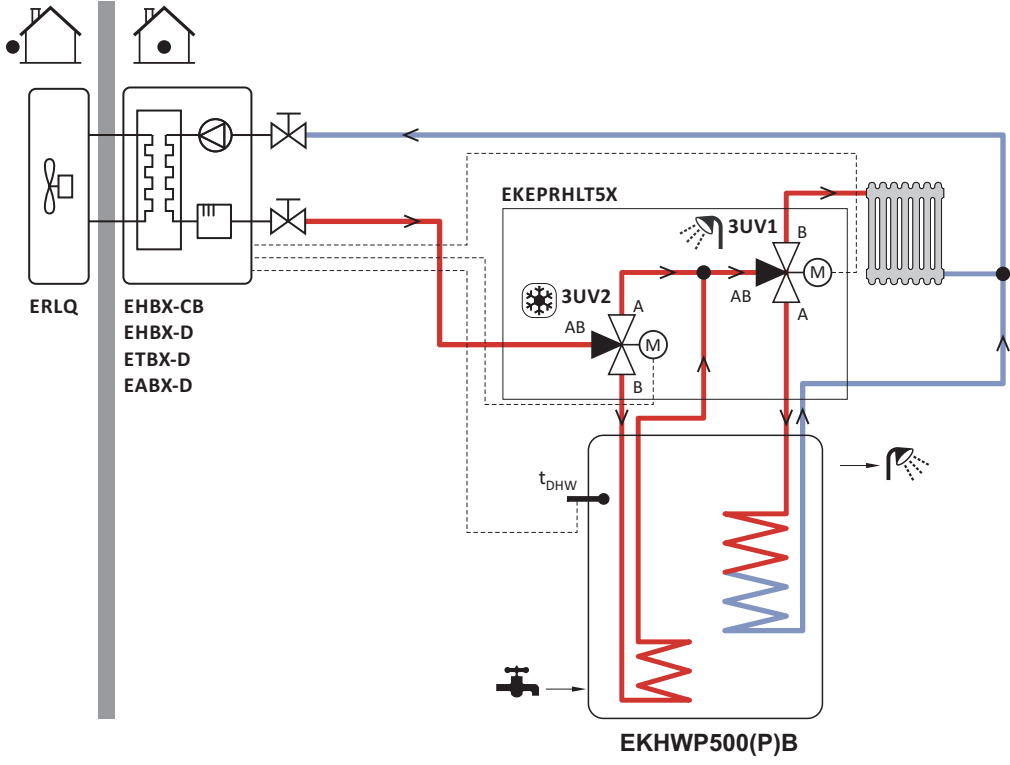

	EN	DE	NL	IT	ES	FR	PT
3UV1	3-way-switch-valve	3-Wege Umschaltventil	3-wegs omschakelklep	Valvolaa 3 vie	Válvula de conmutación de 3 vías	Soupeape d'inversion à 3 voies	Válvula de comutação de 3 vias
3UV2							
t _{DHW}	Storage tank temperature sensor	Speicher-temperaturfühler	Opslagtemperatuur-sensor	Sonda di temperatura del bollitore	Sensor de temperatura de acumulador	Sonde de température de l'accumulateur	Sensor de temperatura do acumulador
Daikin Altherma ST							
EKHWP 500(P)B	Hot water storage tank (500 l)	Warmwasserspeicher (500 l)	Warmwaterboiler (500 l)	Bollitore ad accumulo (500 l)	Acumulador de ACS (500 l)	Réservoir d'eau (500 l)	Acumulador de água quente sanitária (500 l)
ERLQ	Daikin Altherma / outdoor unit						
Daikin Altherma / indoor unit							
EHBX-CB	Daikin Altherma R W						
EHBX-D	Daikin Altherma 3 R W						
ETBX-D	Daikin Altherma 3 H HT W						
EABX-D	Daikin Altherma 3 H W						



EHBX-CB; EHBX-D; ETBX-D; EABX-D + EKEPRHLT5X

EN	DE	NL	IT	ES	FR	PT	
Technical data	Technische Daten	Technische gegevens	Dati tecnici	Datos técnicos	Caractéristiques Techniques	Dados técnicos	
3UV1  / 3UV2 							
3-way-switch-valve	3-Wege Umschaltventil	3-wegs omschakelklep	Valvolaa 3 vie (DHW)	Válvula de conmutación de 3 vías	Soupape d'inversion à 3 voies	Válvula de comutação de 3 vías	
Operating voltage	Betriebsspannung	Bedrijfsspanning	Tensione d'esercizio	Tensión de servicio	Tension de fonctionnement	Tensão de serviço	230V / 50Hz
Maximum power input	Maximale Leistungsaufnahme	Maximale vermogens-opname	Potenza assorbite massima	Absorción de máxima	Puissance absorbée maximum	Máx. consumo de corrente eléctrica	4,3 W
Protection type	Schutzart	Beschermingklasse	Grado di protezione	Grado de protección	Type de protection	Tipo de proteção	IP 40
Turnaround time	Umschaltzeit	Omschakeltijd	Tempo di commutazione	Tiempo de conmutación	Temps d'inversion	Tempo de comutação	6s
KVS-coefficient	KVS-Wert	KVS-coëfficiënt	KVS-Coefficiente	KVS-coeficiente	KVS-valeur	KVS-valor	7,7
Storage tank sensor	Speicherfühler	Opslagtank sensor	Sensore accumulo	Sonda ACS	Sonde ballon	Sensor do acumulador	
R_s							
Resistance characteristics	Widerstandskennlinie	Weerstandskarakteristiek	Linea carrateristica	Curva característica	Caractéristiques de résistance	Linha característica	

EHBX-CB; EHBX-D; ETBX-D; EABX-D + EKEPRHLT5X

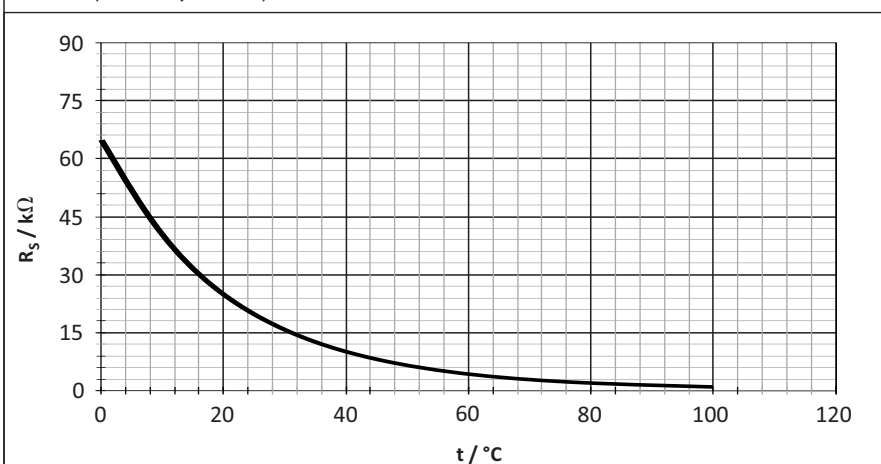



[EKEPRHLT5X]

DAIKIN EUROPE N.V.

Zandvoordestraat 300, B-8400 Oostende, Belgium

008.1447999 01 12/2019

Copyright © Daikin