

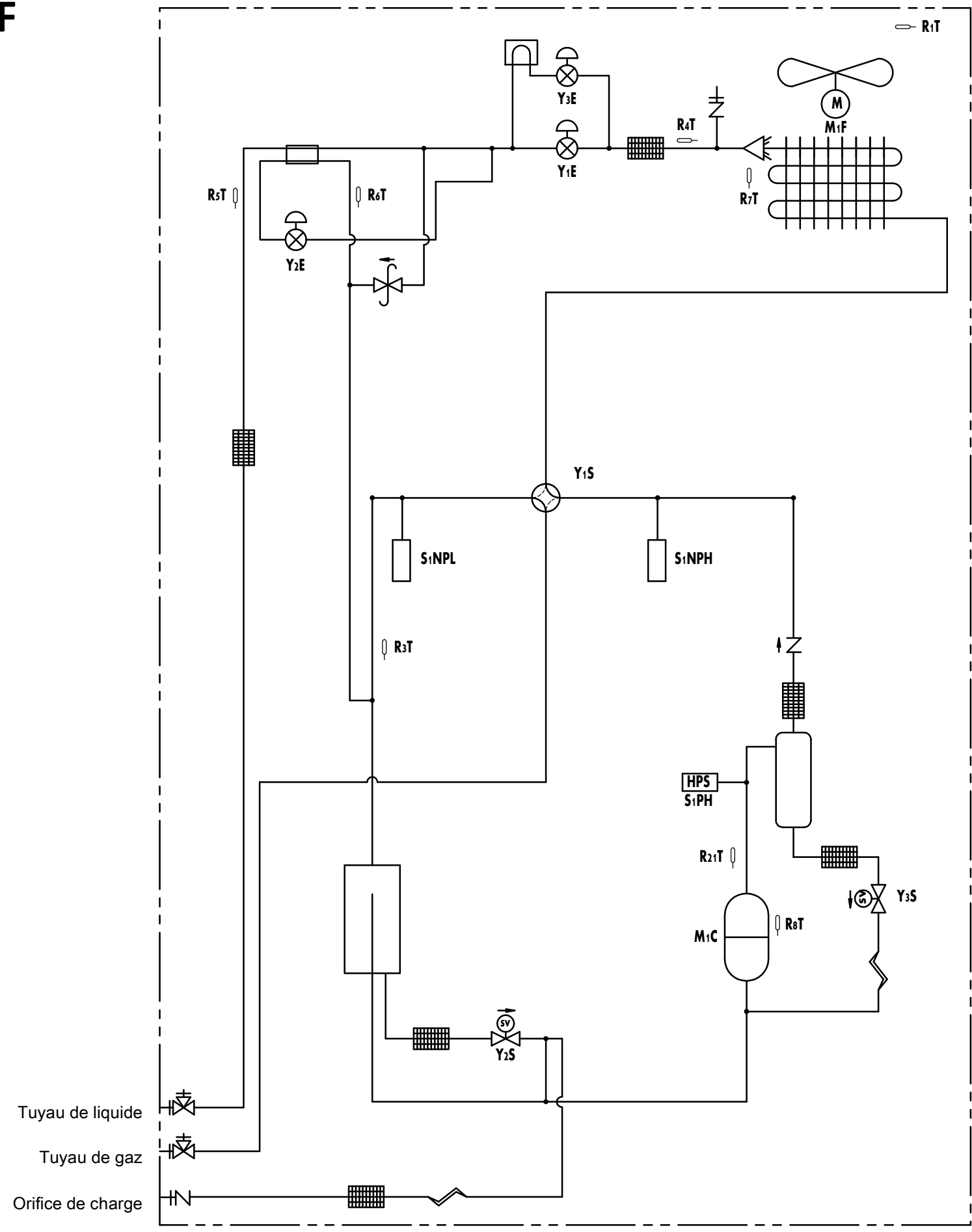





















RXYQ8-12U

RXYTQ8UYF



Tuyau de liquide
 Tuyau de gaz
 Orifice de charge

-  Orifice de charge / Orifice d'entretien
-  Vanne d'arrêt
-  Filtre
-  Clapet anti-retour
-  Soupape de décharge de pression
-  Thermistance
-  Dissipateur thermique (PCB)
-  Tube capillaire
-  Vanne d'expansion
-  Vanne à 4 voies
-  Ventilateur hélicoïdal
-  Commutateur haute pression
-  Capteur basse pression
-  Capteur haute pression
-  Accumulateur
-  Échangeur de chaleur
-  Compresseur
-  Séparateur d'huile
-  Échangeur de chaleur à double tube
-  Distributeur
-  Électrovanne