

UNIVERSAL LIMIT SWITCHES

8384 standard

- › Metal case
- › 3 cables entries
- › Heads have 4 possible positions at 90°
- › All heads protected by nitrile boot and/or ring



Main specifications			
	Steel plunger	Reinforced lever with plastic roller	Stepped adjustment roller lever
Housing			
Metal	Snap action		
General characteristics			
Sequence	Snap action		
	83 840 001	83 841 001	83 842 001
Mechanical characteristics			
Max. operating force (N)	10	15	8
Max. operating torque (N.m)	-	-	-
Max. total travel force (N)	22	25	15
Max. total travel torque (N.m)	-	-	-
Mechanical life (operations)	10 ⁷	10 ⁷	10 ⁷
Operating temperature (°C)	-10 → +70	-10 → +70	-10 → +70
Weight (g)	310	310	310
Comments	Accessories for 83 843 0 (see Dimensions - Accessories) Galvanized, passivated steel lever Thermoplastic roller Supplied with nut, washer and locating block loose		

General characteristics	
Conformity to standards	IEC / EN 60947-5-1, including Annex K for version with positive break operation CE
Version	Single-pole
Degree of protection IEC 60529	IP66
Connections	Saddle washer and screw M3.5
Wire max. cross-section	2 mm ²
Electrical protection	Internal earth terminal
Cable entry	3 entries for No. 13 sealing gland, 20.4 Ø, 1.411 pitch (supplied with 2 screw plugs)
Assigned impulse voltage (U _{imp}) V	4000
Assigned insulation voltage (U _i) V	500
Thermal current (I _{th}) A	10
Assigned working characteristics (EN 60 947.5.1)	A300 = AC15 240 V 3 A / 120 V 6 A Alternating current Q150 = DC13 125 V 0.55 A Direct current

Product adaptations



- › -40 °C operating temperature (silicone version)
- › Steel roller levers
- › UL approval : consult us



Adjustable roller lever	Adjustable roller lever with idle-return	Rotary head, momentary action to right and left	Steel roller plunger	Flexible metal lever
83 842 101	83 842 201	83 843 001	83 845 001	83 846 001
8	8	-	10	1.5
-	-	0.2	-	-
15	15	-	22	2.5
-	-	0.33	-	-
10 ⁷	10 ⁷	-	10 ⁷	10 ⁷
-10 → +70	-10 → +70	-20 → +70	-10 → +70	-10 → +70
310	310	310	300	310

Principles

Function
Four-terminal double break two-way contact element (form Za). The contacts must be of the same polarity.



Curves

Operating curve for standard version

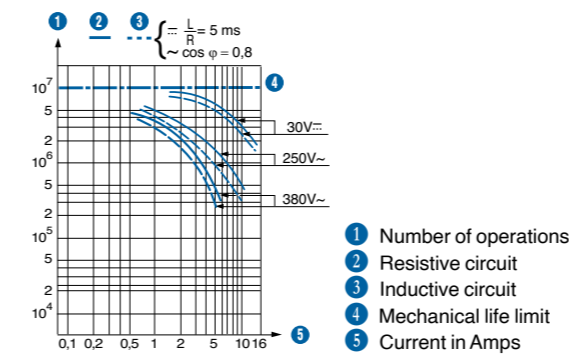

Dimensions

Product

Body

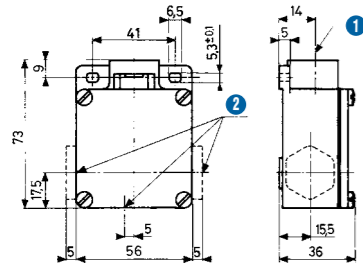

- 1 Axis of heads
- 2 No. 13 sealing gland

83 840 0

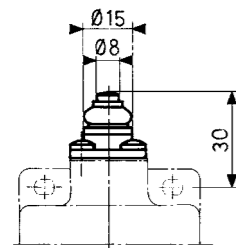

83 841 0

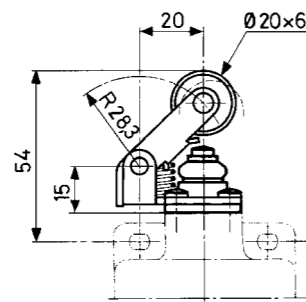

83 842 0

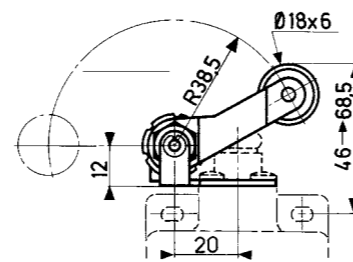

Adjustable in 8° steps

83 842 1

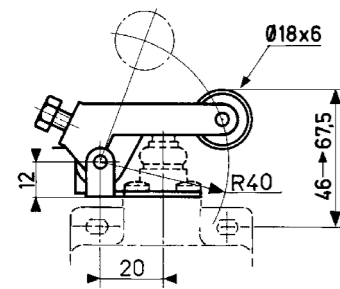

83 842 2

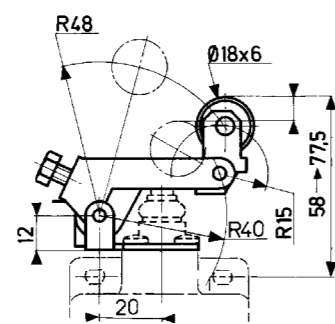

83 843 0

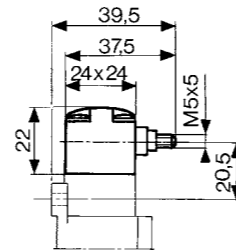

83 845 0

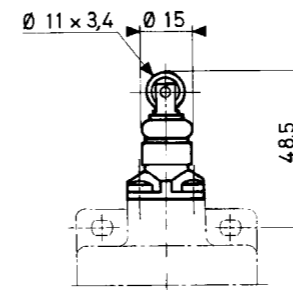

83 846 0

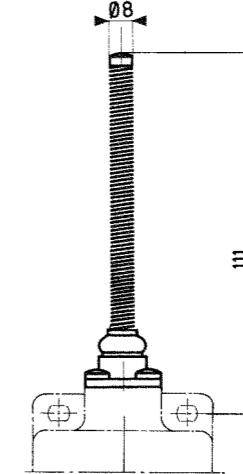

Accessories

79 210 997 (for 83 843 0)

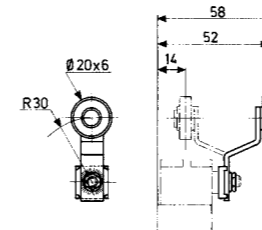

79 210 998 (for 83 843 0)

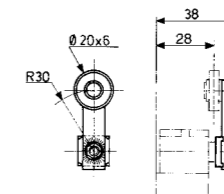

Lever angular settings

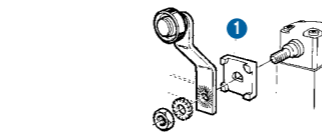

1 Block
Adjustable in 90° steps

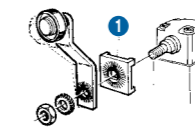

1 Block turned
Adjustable in 6° steps

Warning:

The product information contained in this catalogue is given purely as information and does not constitute a representation, warranty or any form of contractual commitment. Crouzet and its subsidiaries reserve the right to modify their products without notice. It is imperative that we should be consulted over any particular use or application of our products and it is the responsibility of the buyer to establish, particularly through all the appropriate tests, that the product is suitable for the use or application. Under no circumstances will our warranty apply, nor shall we be held responsible for any application (such as any modification, addition, deletion, use in conjunction with other electrical or electronic components, circuits or assemblies, or any other unsuitable material or substance) which has not been expressly agreed by us prior to the sale of our products.

UNIVERSAL LIMIT SWITCHES

8384 with positive break operation

- › Metal case
- › 3 cables entries
- › Heads have 4 possible positions at 90°
- › All heads protected by nitrile boot and/or ring



Main specifications		Steel plunger	Reinforced lever with plastic roller
Housing	Action		
Metal	Snap action		
General characteristics			
Sequence			
Snap action			
Mechanical characteristics			
Max. operating force (N)		10	15
Max. operating torque (N.m)		-	-
Minimum positive opening force (N)		10	15
Min. positive opening torque (N.m)		-	-
Minimum total travel force (N)		22	25
Minimum total travel torque (N.m)		-	-
Mechanical life (operations)		10 ⁷	10 ⁷
Operating temperature (°C)		-10 → +70	-10 → +70
Weight (g)		310	310
Comments			
Accessories for 83 843 7 (see Dimensions - Accessories)			
Galvanized, passivated steel lever			
Thermoplastic roller			
Supplied with nut, washer and locating block loose			

General characteristics	
Conformity to standards	IEC / EN 60947-5-1, including Annex K for version with positive break operation
Version	Single-pole
Degree of protection IEC 60529	IP66
Connections	Saddle washer and screw M3.5
Wire max. cross-section	2 mm ²
Electrical protection	Internal earth terminal
Cable entry	3 entries for No. 13 sealing gland, 20.4 Ø, 1.411 pitch (supplied with 2 screw plugs)
Assigned impulse voltage (U _{imp}) V	4000
Assigned insulation voltage (U _i) V	500
Thermal current (I _{th}) A	2.5
Assigned working characteristics (EN 60 947.5.1)	C300 = AC15 240 V 0.75 A / 120 V 1.5 A Alternating current R300 = DC13 250 V 0.11 A / 125 V 0.22 A Direct current
Short circuit test	Conforms to IEC 60947.5.1 paragraph 8.34
Current peak	1000 A at 250 VAC 0.5 < cos φ < 0.7
Short circuit protection device	Fuse 10 AgG

Product adaptations



- › -40 °C operating temperature (silicone version)
- › Steel roller levers
- › UL approval : consult us



Stepped adjustment roller lever	Adjustable roller lever	Adjustable roller lever with idle-return	Rotary head, momentary action to right and left	Steel roller plunger
83 842 701	83 842 801	83 842 901	83 843 701	83 845 701
8	8	8	-	10
-	-	-	0.2	-
10	10	10	-	10
-	-	-	0.2	-
15	15	15	-	22
-	-	-	0.33	-
10 ⁷	10 ⁷	10 ⁷	10 ⁷	10 ⁷
-10 → +70	-10 → +70	-10 → +70	-20 → +70	-10 → +70
310	310	310	310	300

Principles

Function
Four-terminal double break two-way contact element (form Za) with positive break operation on NC contacts (1-2) according to IEC/EN60947-5-1 Annex K. The contacts must be of the same polarity.

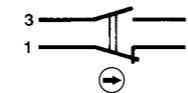

Curves

Operating curve for positive break version

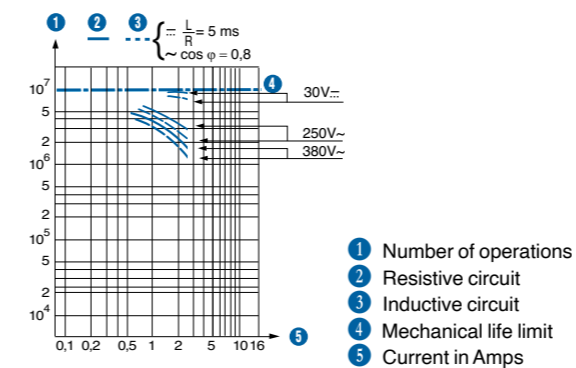

Dimensions

Product

Body

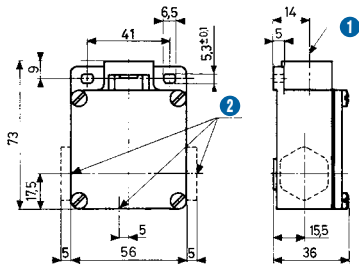

- 1 Axis of heads
- 2 No. 13 sealing gland

83 840 7

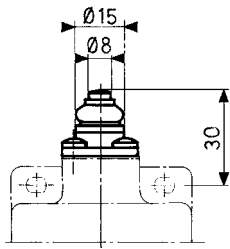

83 841 7

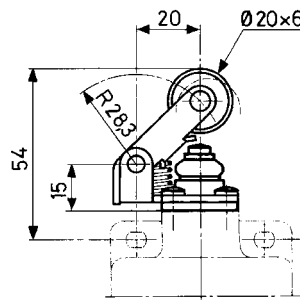

83 842 7

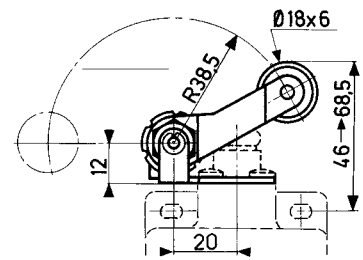

Adjustable in 8° steps

83 842 8

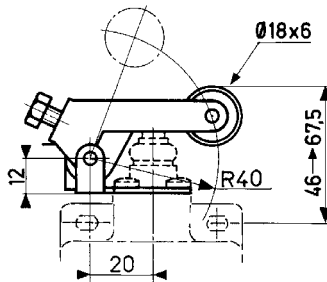

83 842 9

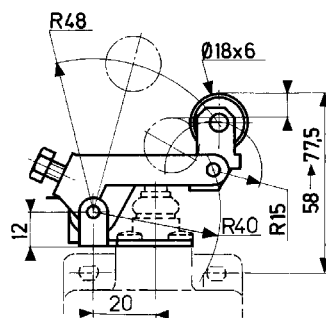

83 843 7

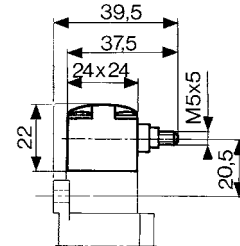

83 845 7

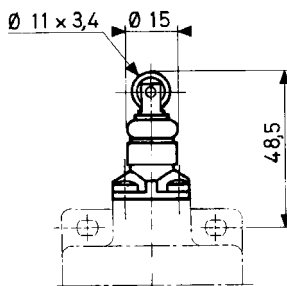

Accessories

79 210 997 (for 83 843 7)

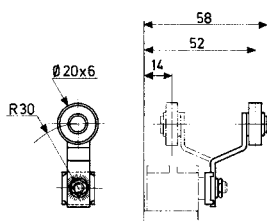

79 210 998 (for 83 843 7)

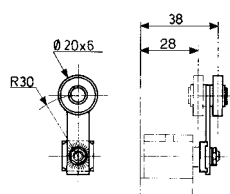

Lever angular settings

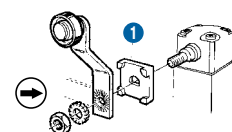

- 1 Block
Adjustable in 90° steps
Block 1 must not be mounted the other way round

Warning:

The product information contained in this catalogue is given purely as information and does not constitute a representation, warranty or any form of contractual commitment. Crouzet and its subsidiaries reserve the right to modify their products without notice. It is imperative that we should be consulted over any particular use or application of our products and it is the responsibility of the buyer to establish, particularly through all the appropriate tests, that the product is suitable for the use or application. Under no circumstances will our warranty apply, nor shall we be held responsible for any application (such as any modification, addition, deletion, use in conjunction with other electrical or electronic components, circuits or assemblies, or any other unsuitable material or substance) which has not been expressly agreed by us prior to the sale of our products.