

BASIC TECHNICAL CONCEPTS

INTRODUCTION

Our microswitches are high-precision, snap-action switches and these are the main features for which they are notable:

- › Fast and reliable switching largely independent of actuating speed
- › High electrical ratings but small dimensions
- › High repeat accuracy of switching points and forces
- › Low operating force
- › Short pre-travel but large overtravel
- › Very long service life
- › Extensive range of connections, fixing means and actuators for easy adaptation to numerous applications.

MICROSWITCH CONSTRUCTION - ELECTRICAL FUNCTIONS

› Single-break changeover SPDT Microswitch (e.g. V3 83161)

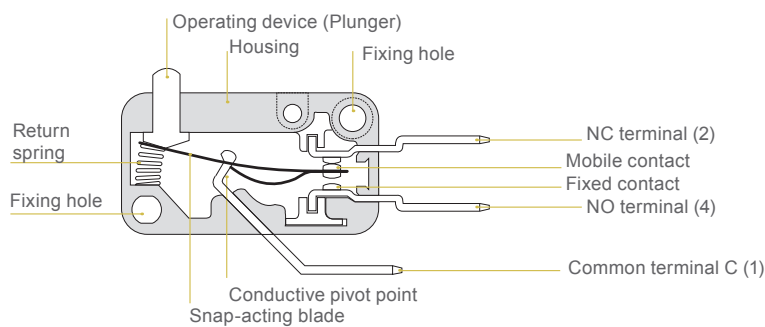

Changeover SPDT (Form C)

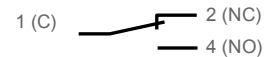

Normally Closed SPST-NC (Form B)

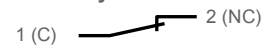

Normally Open SPST-NO (Form A)



› Double-break changeover SPDT Microswitch (e.g. 83132)

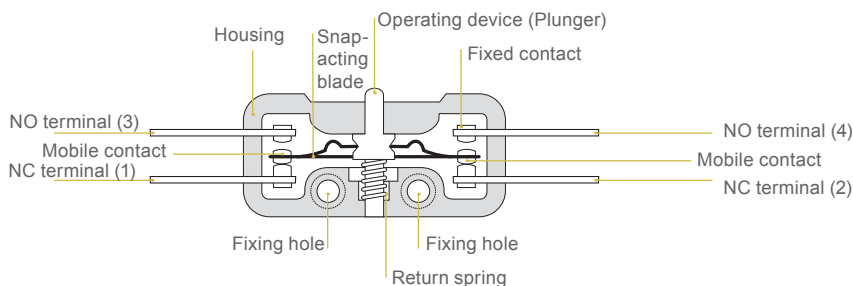

Changeover SPDT (Form Za)

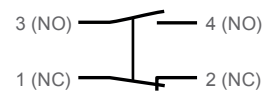

Normally closed SPST-NC (Form Y)



Normally open SPST-NO (Form X)



NO and NC circuits must be used at same polarity.

› Double-break changeover SPDT Microswitch with separated circuits (e.g. PBX 8324)

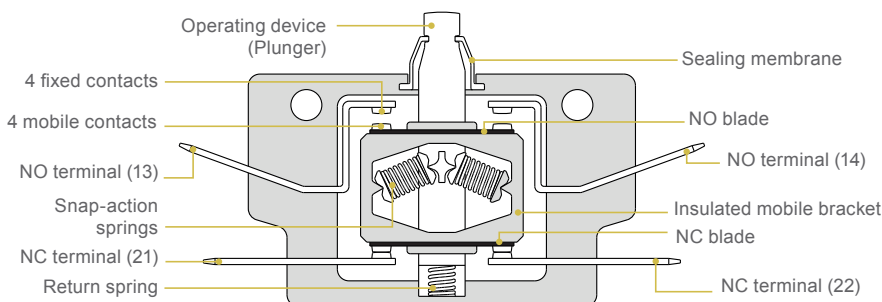

Changeover SPDT (Form Zb)



NO and NC circuits are electrically separated, and can be used at opposite polarities.

› Positive (or direct) opening operation according to IEC 60947-5-1 Annex K (depending on models)

An additional internal mechanism, made of non-resilient parts, forces the opening of NC contacts in case of accidental welding (overload, short-circuit, ...) or snap-action mechanism failure.

Models fitted with this function are particularly suitable for safety related applications according to ISO 13849-1 or EN 60204-1.

To ensure proper functioning of positive opening operation, the operating device must be depressed up to the positive opening position.



› Maintained action / Bistable reset variants

Double-break microswitches (Form Za, X, Y and Zb) are particularly suitable for achieving this kind of "mechanical memory" function. Return spring is removed, and operating device has special shape for push/pull actuation.

Typical applications are level regulation, manual reset and position contacts for bistable electromagnets.

MECHANICAL CHARACTERISTICS

› Terminology: Forces - Positions - Travels

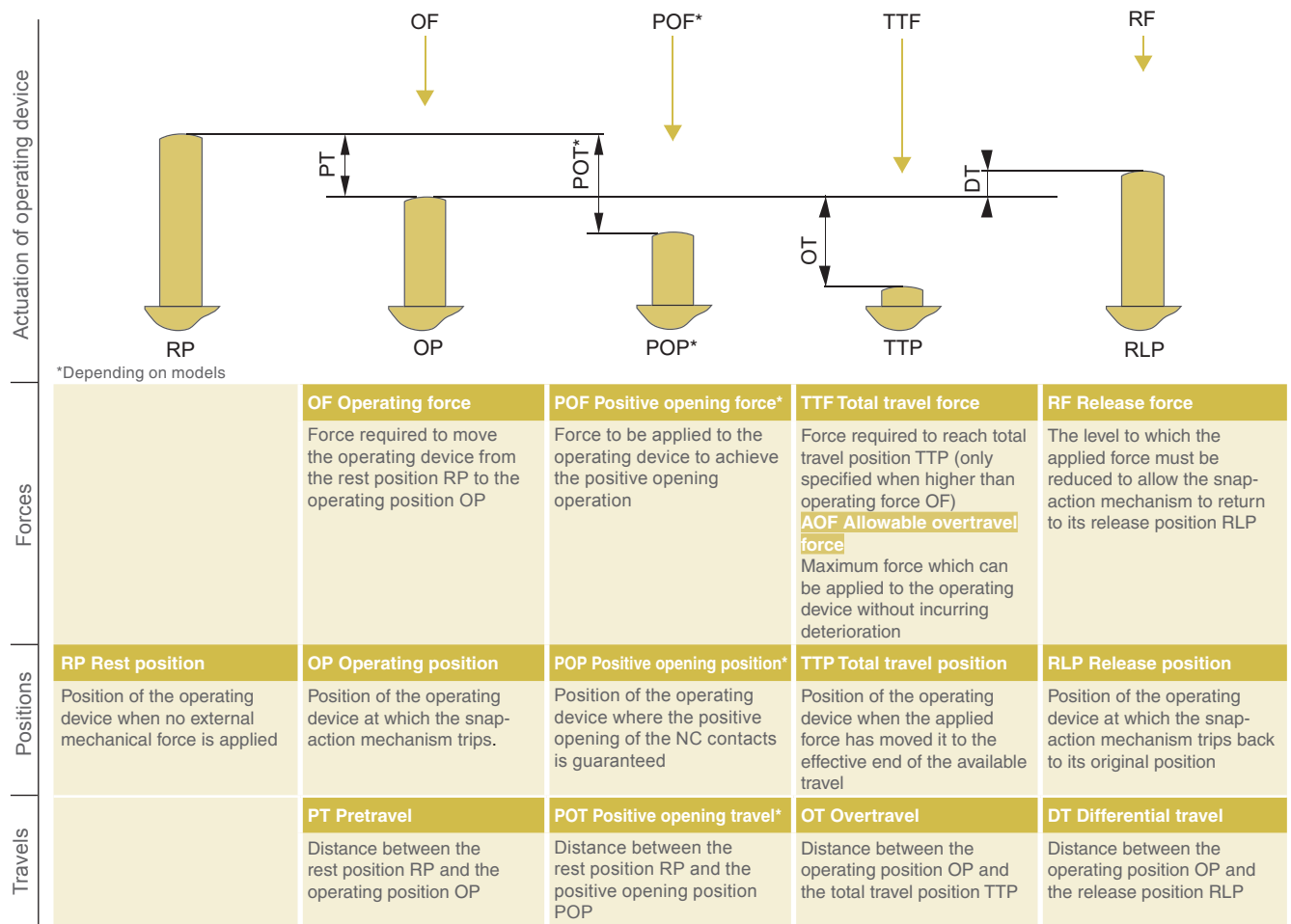

The reference point for the figures given for travels and forces is a point F located on the top of the plunger in the case of a plain microswitch, or, generally, 3 mm in from the end of a flat lever. The reference point for the positions is one of the fixing holes, unless otherwise indicated.

› Force - Travel diagrams

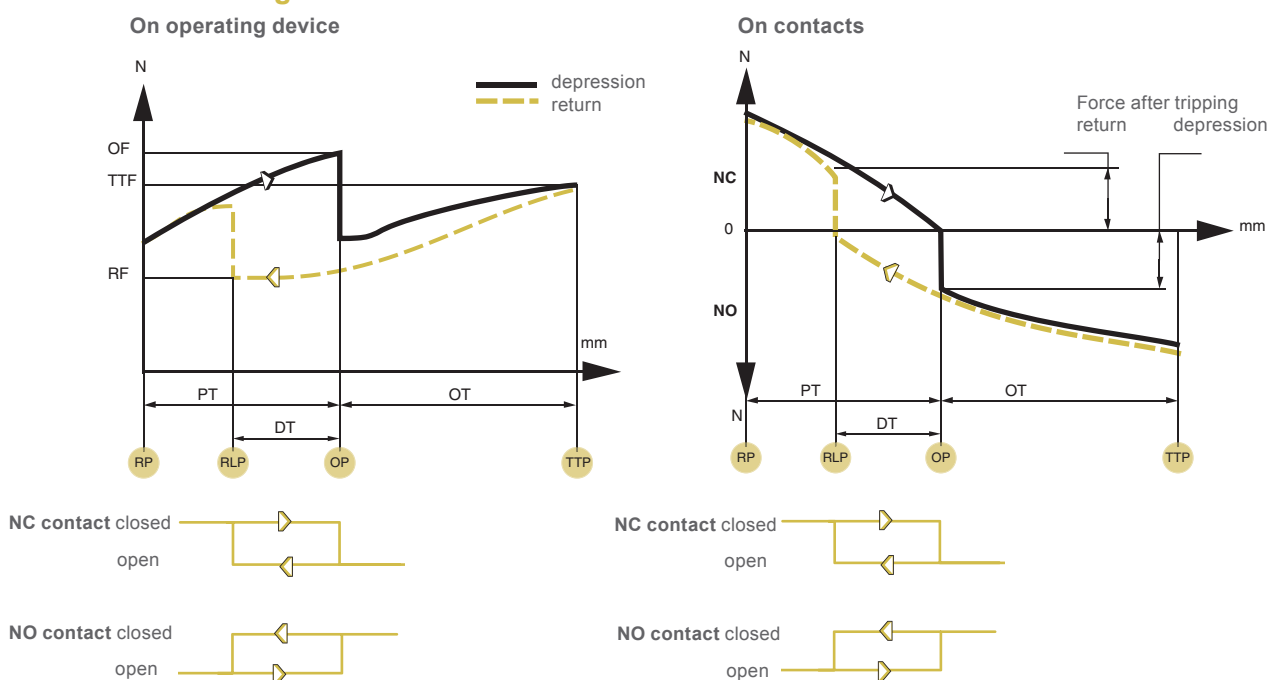

MECHANICAL CHARACTERISTICS

› Changeover time

This is the time taken by the mobile contact when moving from one fixed contact to another until it becomes fully stable (contact bounce included). This time is a function of the contact gap, the mechanical characteristics of the snap action and the mass of the mobile element.

However, thanks to the snap-action mechanisms employed, the time is largely independent of the speed of operation. It is normally less than 20 milliseconds (including bounce time less than 5 ms).

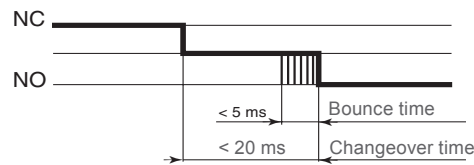

› Actuating speed - Rate of operation

Our microswitches are suitable for actuating speeds varying over a very wide range: typically from 1 mm/min to 0,5 m/s. The maximum rate of operation with a low electrical load may be as high as 10 cycles / second.

› Direct actuation on plunger

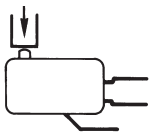

The plunger should preferably be actuated along its axis (front actuation). However, the majority of our microswitches can accept lateral approach provided the angle of actuation is not more than 45°.

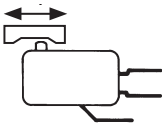

The actuating device shall not limit the plunger travel to the operating position (OP). It must always depress the plunger through at least 0.5 times the defined overtravel (OT), or up to the positive opening position (POP) if applicable. Steps

must also be taken to ensure that it does not exceed the total travel position (TTP) nor the allowable overtravel force (AOF).

› Operation by auxiliary actuator (lever)

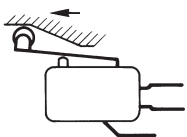

When the roller lever is laterally approached, force should preferably be applied in the direction shown.

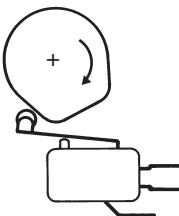

Where the movements involved are fast, the ramp should be designed to ensure that the operating device is not subjected to any violent impact or abrupt release.

› Mechanical durability

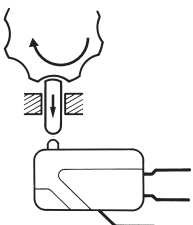

This is an indicative value of the number of possible operating cycles without an electrical load.

It may be useful for evaluation purposes in cases where the power levels involved are very low and the electrical life is thus close to the mechanical life.

ELECTRICAL CHARACTERISTICS

› Max rating / Making & Breaking capacities

This is the max current the microswitch is capable of making and breaking for at least 6000 cycles.

On DC current, the breaking capacity is extremely dependent on the voltage, the contact gap and the nature of the load being switched. There is a risk of prolonged or permanent arcing if the following limits are exceeded:

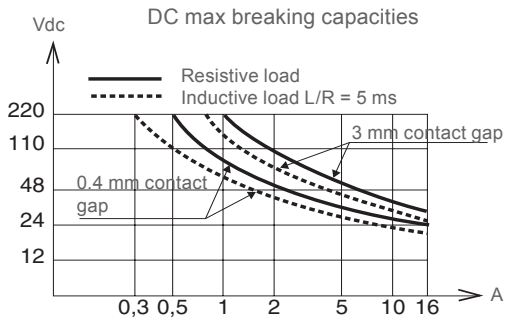

DC breaking capacity can be significantly increased by using different means, if necessary in combination:

- Arc reduction device (see «Electrical recommendations»)
- Double-break microswitch
- Microswitch with magnetic blow-out
- Use of several microswitches connected in series and operated simultaneously

For making and breaking capacities according to utilization categories AC12, AC13, AC14, AC15 and DC12, DC13, DC14 defined by IEC/UL/EN 60947-5-1: refer to our datasheets.

For special applications, please consult us.

› Nominal rating

This is the current the microswitch is capable of making and breaking, for a given number of cycles (typically 100 000 cycles). Nominal rating generally corresponds to the highest ampere rating shown on the operating curve.

› Thermal rating

This is the amount of current the microswitch can withstand when not being operated; for a terminal temperature rise of not more than 60°C.

› Electrical durability

Operating curves indicate the electrical life of the microswitches, under standard conditions (20°C, 1 cycle/2 seconds), by showing the number of switching cycles that can be performed with varied types of loads.

Note: for sealed products and/or for DC ratings, the rate of operation is reduced to 1 cycle/6 seconds.

Example:

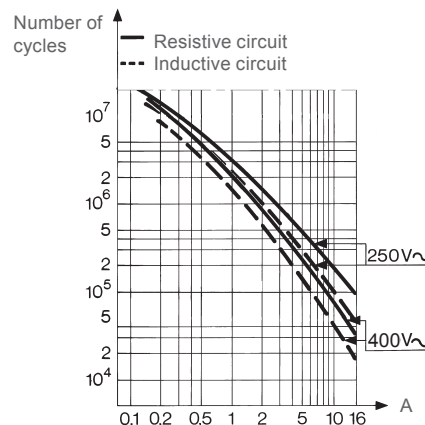

› Influence of load type

Resistive load



This is the reference load that is used for determining the nominal rating. Switching a resistive load, making and breaking, does not create specific problem.

Inductive load

$$\tau = \frac{L}{R}$$



Electromagnets or motors are typical examples. They are characterized by a $\cos \varphi < 1$ in AC or by a time constant $L / R > 0\text{ms}$ in DC.

Breaking these loads creates powerful arcing that accelerates erosion of contacts.

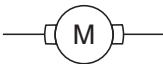

Making these loads often generates inrush current up to 6 times the rated current, which increases the risk of contact welding.

In addition, in DC, the phenomenon of contact material relocation is increased.

Ratings and / or life are reduced and special contacts may be needed: please contact us.

Also refer to «Electrical recommendations».

Capacitive load and lamps

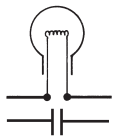

Making these loads generates inrush current up to 15 times the rated current, which greatly increase the risk of contact welding.

In addition, in DC, the phenomenon of contact material relocation is strongly accentuated.

Breaking these loads is equivalent to that of a resistive load and does not cause any particular problems.

Ratings and / or life are reduced and special contacts may be needed: please contact us.

› Contact resistance

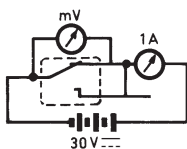

This is the electrical resistance measured at the terminals of the switch when the contacts are closed. It consists of the (variable) resistance of the contact point and the (fixed) resistance of the current carrying parts.

It is generally less than 20 mΩ, when the plunger is in rest position or total travel position.

Near the operating or released positions, the contact force decreases and the resistance may increase substantially.

› Insulation resistance

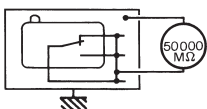

The insulation resistance of our microswitches is generally greater than 50 000 MΩ measured at 500 V DC.

› Dielectric withstand voltage

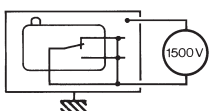

The dielectric withstand voltage of our microswitches is generally higher than values specified by IEC/UL/EN 61058-1 for 250V rated voltage:

- 1500 volts between live parts and ground (basic insulation)
- 1500 volts between open contacts for contact gap >1.5mm (full disconnection)
- 500 volts between open contacts for contact gap <1.5mm (micro-disconnection “μ”)

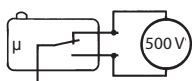

CONTACT MATERIALS

› Choice of contact material

To choose the best material for the contacts there are various factors to be considered:

- Current and voltage levels
- Type of load
- Potential inrush current
- Number of cycles
- Rate of operation
- Environmental conditions

› Contacts for general use

Our microswitches are normally fitted with silver or silver-nickel contacts. These are suitable for the majority of applications and provide the best compromise between electrical performance, thermal performance and service life.

› Contacts for low-energy circuits

For applications at $V < 20\text{V}$ and/or $I < 100\text{mA}$, especially if $P < 0.3\text{ VA}$, we recommend to use contacts with gold (or gold alloy) coating, especially if the switching frequency is low (e.g. <1 cycle / week), or in the presence of sulfide atmosphere or other corrosive environments.

The lower limits are not specifically defined, but a proper functioning can usually be assumed down to 4V 1mA. Below this level, please consult us or refer to «Electrical recommendations».

› Contacts for special applications

We can supply special contacts suitable for various applications, such as:

- AgSnO₂ contacts for very high inrush current
- Gold plated AgNi contacts, possibly with a crossbar arrangement, to cover a very wide operating range allowing a single part number to be used on different applications (dual-current models).

ELECTRICAL RECOMMENDATIONS

› Inductive circuits

To increase the life of contacts and the DC breaking capacity, the arcing on contact opening can be reduced by using the following protective circuits:

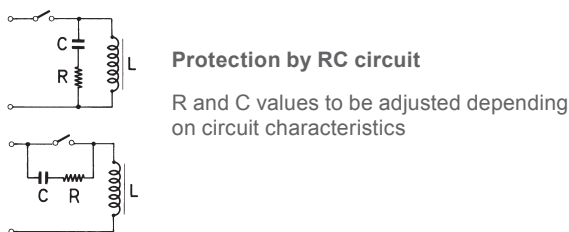
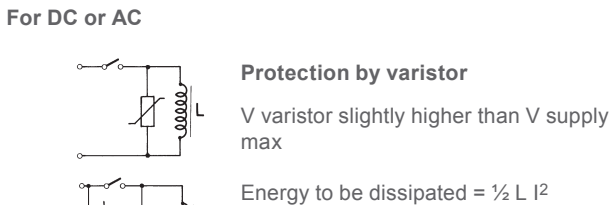
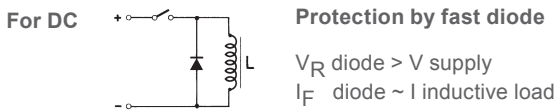

› Very low-energy circuits

Switching very low energy circuits ($I < 1\text{mA}$, $V < 4\text{V}$) is highly sensitive to environmental conditions like corrosive atmospheres and pollutions.

In order to improve the contact reliability, the electrical circuit should allow the passage of at least a few mA through the contacts, and at least when the contacts are closing.

Also, the higher the voltage across open contacts, the better the reliability when the contacts are closed.

ENVIRONMENTAL CONDITIONS

› Operating temperature



The temperature range covered by our line of microswitches extends from -60°C to $+250^\circ\text{C}$.

Operating limits are defined for each type of microswitch. Within these limits, most of the mechanical and electrical characteristics are preserved. However, for cases of intensive use (e.g. numerous thermal cycles with high electrical load) performance may be reduced. For more information please contact us.

› Resistance to shock and vibration

Resistance to shock and vibration depends on the mass of the moving parts and on the forces holding the contacts together. The criterion of satisfactory performance is the absence of micro-opening of contacts.

Microswitches without auxiliary actuator usually exceed the following levels when plunger is in rest position or total travel position:

- Vibration (sinusoidal): 10gn, 10 to 500Hz
- Shock: 50gn 11ms half-sine pulse

Further information on request.

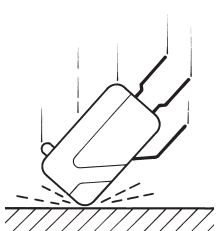

› Degree of protection

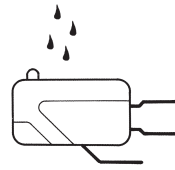

Degrees of protection provided by enclosures against access to hazardous parts, against ingress of solid foreign objects and against harmful ingress of water are defined in IEC 60529 by an IP code followed by two digits.

1st characteristic numeral	
Protection of equipment against ingress of solid foreign objects	Protection of persons against access to hazardous parts
0 (not protected)	(not protected)
4 diameter $\geq 1 \text{ mm}$	1 mm \varnothing wire
5 dust-protected	1 mm \varnothing wire
6 dust-tight	1 mm \varnothing wire

2nd characteristic numeral	
Protection of equipment against ingress of water with harmful effects	
0 (not protected)	
4 splashing	
5 jetting	
6 powerful jetting	
7 temporary immersion	
8 continuous immersion	
9 high pressure and temperature water jet	

Under this classification, our microswitches mainly come within the following categories:

- IP40 (with insulated connections): when no indication
- IP65, IP66, IP67, IP69: sealed microswitches, as indicated

INSTALLATION RECOMMENDATIONS

› Mounting - Insulation

Our microswitches are built in accordance with the rules of protection against electric shock defined by IEC/UL/EN 60947-5-1 or IEC/UL/EN 61058-1.

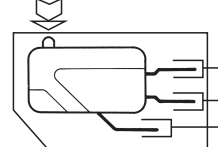

Unless otherwise indicated, they are intended for Class I devices and their envelopes provide basic insulation.

Microswitches for Class I equipment are also suitable for Class II equipment, with appropriate installation conditions in the equipment.

Class II microswitches can be used directly in Class II equipment (and also Class 0, I, and III) without additional protection.

The integrator shall take appropriate measures to ensure protection against electric shock (clearances and creepage distances) after installation and connection in the application.

For example:

- An insulating pad may be required between the microswitch and a conductive mounting surface, or between two microswitches mounted side by side (optional accessory)
 - Actuation of the operating device may require the use of an intermediate part providing supplementary insulation
 - Connections must be protected against direct contact
- Please contact us for any additional information related to the considered microswitch.

› Fixing – Tightening torque

Unless otherwise indicated, the tightening torque of the fixing screws must conform to the following values:

Ø of fixing screw	mm	2	2.5	3	3.5	4
Tightening torque	max.	0.25	0.35	0.6	1	1.5
in N.m	min.	0.15	0.25	0.4	0.6	1

› Processing

Silicone containing substances must be excluded from the close environment of the microswitches because of their negative effect on the contact resistance.

For the same reason, cyanoacrylate adhesives must be avoided or carefully selected and tested prior to production run.

Also, grease and oil shall be avoided from the close environment of the microswitches or shall be evaluated for chemical compatibility with plastics.

Moreover, grease and oil shall never penetrate inside the microswitches.

Ultrasonic welding process in the close environment of the microswitches may affect the contacts and the mechanism. Therefore, suitable tests and analysis shall be conducted prior to production run.

Tin soldering must be carried out under an extractor hood in order to avoid the penetration of solder vapors inside the microswitches, that may have negative effect on the electric functioning.

QUALITY

Crouzet undertakes a pro-active quality policy adapted to our different markets of which the objectives are:

- To actively contribute to the success to our clients
- To ensure the perennial development of the company and the brand by achieving global performance (social, economic, product and service offer) in the field of environment and legislation.

This quality implies:

- Mobilization and dynamic behavior by the entire staff
- Achieving results and respecting our commitments
- Sharing our policies with our partners (clients, suppliers...).

This quality is based on a series of ongoing actions focusing on the preventative:

- Quality starts from the understanding of the clients needs in order to work out the specifications where Crouzet acts as expert advisor.
- Quality is pro-active in actions for progress
- Quality ensures the systematic exploitation of feedback experience, methods and quality tools.

Our plants are certified to:

- **ISO 9001:** quality management systems
- **IATF 16949:** particular requirements of quality management systems for automotive production
- **ISO/IEC 80079-34:** application of quality systems for explosive atmospheres equipment manufacture
- **ISO 45001:** occupational health & safety management systems.

Certificates can be obtained from www.crouzet.com

STANDARDS, TESTING AND APPROVALS

Our microswitches are designed and tested according to international standards like:

- EN/UL/IEC 60947-5-1 for general industrial applications
- EN/UL/IEC 61058-1 for household and similar appliances
- EN/IEC 60079-1 for explosives atmospheres applications.

The Crouzet laboratory is compliant with ISO/IEC 17025 and is certified to:

- CTF3 (Customer Testing Facilities) by UL, for electrical tests in accordance with EN/UL/IEC 61058-1
- CTDP (Client Test Data Program) by UL, for electrical tests in accordance with UL 61058-1.

Proof of compliance with these standards is demonstrated by:

- The manufacturer's declaration of conformity (drafted in accordance with ISO/IEC 17050), or
- Approvals granted by accredited bodies, like LCIE (for ENEC, NF, ATEX, IECEx approvals), UL (for cURus, cULus approvals), CQC (for CCC approvals)...

Approval certificates and declarations of conformity can be obtained from www.crouzet.com

Concerning machinery applications; EN/IEC 62061 and EN/ISO 13849-1 standards for safety of machinery require the component manufacturers to provide data allowing the equipment manufacturers to calculate the Mean Time To Failure (MTTF) and to determine the Safety Integrity Level (SIL) or the Performance Level (PL) of the safety related parts of their control systems.

Reliability data for switches according to EN/ISO13849-1 can be obtained from www.crouzet.com

Note: with appropriate wiring and monitoring system, safety related parts of control systems containing switches, notably switches with positive opening operation, can reach PL e / Category 4 according to EN/ISO 13849-1, and SIL 3 according to EN/IEC 62061.

RULES AND REGULATIONS

› EU directives

Our microswitches conform to:

- Low Voltage directive 2014/35/EU
- ROHS directive 2011/65/EU
- ATEX directive 2014/34/EU when applicable.

In addition, they can be used within the framework of Machinery directive 2006/42/EC.

Note about Electromagnetic Compatibility (EMC) directive 2014/30/EU:

- Microswitches, as electromechanical components and as stated in EN/IEC 60947-1, are not sensitive to electromagnetic disturbances and their emissions, generated only when switching, are considered as part of the normal electromagnetic environment of low-voltage installations. Therefore, all of our switches are compliant with the EMC directive.

› Environmental protection

Protection of the environment is an integral part of the manufacturing process of our microswitches, from design to packaging.

- **ISO 14001:** all of our plants are certified. Certificates can be obtained from www.crouzet.com
- **REACH:** Crouzet takes into account any change of the Reach regulation 1907/2006. None of our switches contain substances from the authorisation list.
- **WEEE:** in compliance with WEEE 2012/19/EU directive, Crouzet adheres to an accredited eco-organism named ECO-SYSTEM. Switches are in the scope of WEEE from 2018.