







7T.81

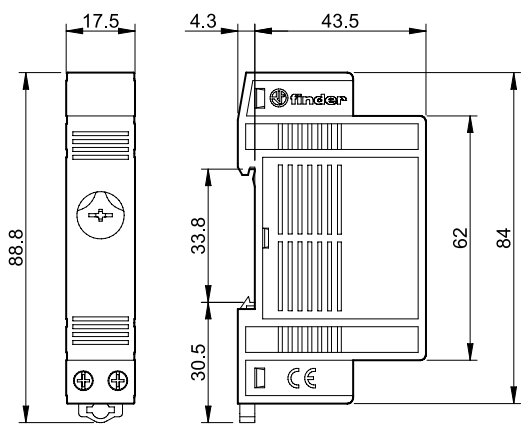
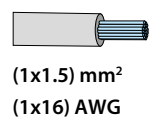
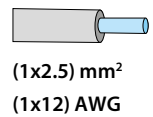

	7T.81.0.000.240x	7T.81.0.000.230x
	1 NC (SPST-NC) 10 A 250 V AC	1 NO (SPST-NO) 10 A 250 V AC
	AC1 2500 VA AC15 (230 V AC) 250 VA AC3 (230 V AC) 1.1 kW DC1 (30/110/220)V (1/0.3/0.15)A	
K	7 ± 4	
	(-45...+80)°C	
	IP20	



 Type of action: 1B
Pollution degree: 2
Rated impulse voltage 2.500 V

7T.81.0.000.2401 (-20...+40)°C
7T.81.0.000.2402 (-20...+60)
7T.81.0.000.2403 (0...+60)°C

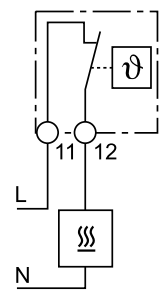
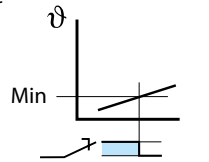
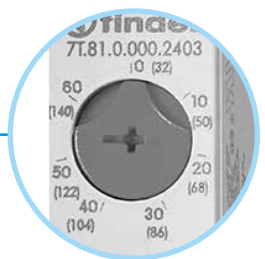
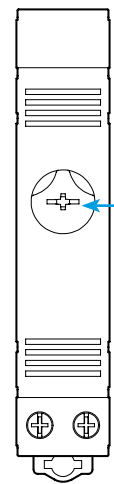

7T.81.0.000.2301 (-20...+40)°C
7T.81.0.000.2302 (-20...+60)
7T.81.0.000.2303 (0...+60)°C

