

THIS COPY IS PROVIDED ON A RESTRICTED BASIS AND IS NOT TO BE USED IN ANY WAY DETRIMENTAL TO THE INTERESTS OF PANDUIT CORP.

UNIVERSAL AISLE CONTAINMENT
WITH VERTICAL WALLS
(TYPICALLY USED FOR HOT
AISLE CONTAINMENT)

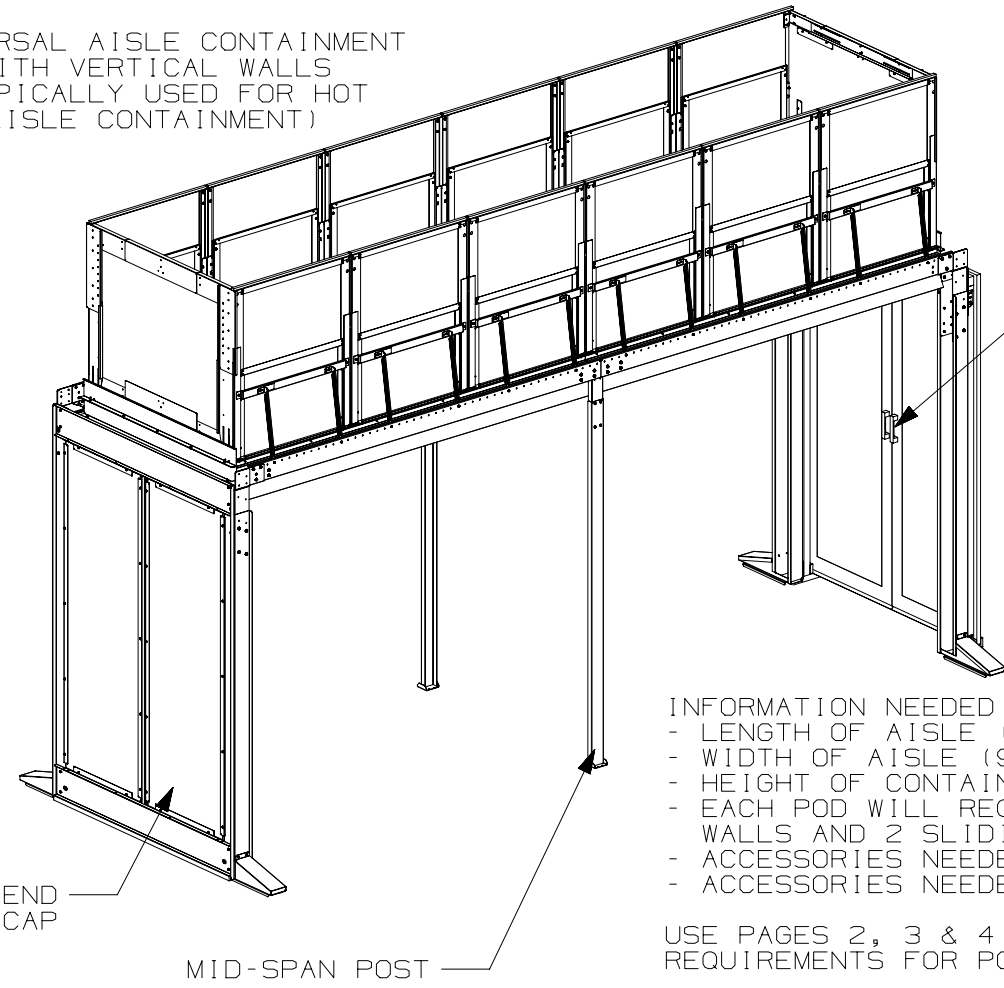

DUAL SLIDING DOORS

END CAP

MID-SPAN POST

- INFORMATION NEEDED TO CONFIGURE A UNIVERSAL AISLE CONTAINMENT POD:
- LENGTH OF AISLE (MUST BE IN 100mm INCREMENTS)
 - WIDTH OF AISLE (900mm, 1200mm)
 - HEIGHT OF CONTAINED AISLE (42RU, 45RU, 48RU OR 52RU)
 - EACH POD WILL REQUIRE 2 END-OF-ROW FRAMES, 2 END-OF-ROW VERTICAL WALLS AND 2 SLIDING DOOR KITS (OR 1 SLIDING DOOR AND 1 END CAP)
 - ACCESSORIES NEEDED FOR PROPER SUPPORT
 - ACCESSORIES NEEDED FOR PROPER CONTAINMENT

USE PAGES 2, 3 & 4 TO DETERMINE HEIGHT, LENGTH AND WIDTH REQUIREMENTS FOR POD.

USE PAGE 5 TO DETERMINE REQUIRED ACCESSORIES.



D10100DA/16

REV	DATE	BY	CHK	APR	DESCRIPTION	ECN
01B	2/9/21	MEX-JAGC	PATR	PATR	UPDATED VIEWS TO REMOVE NOT NEEDED PARTS	V09002LE/00
01A	6-7-16	LEE	SSP	SGI	ADDED SHEET (INSERTED SHEET 3)	V09000WR
00A	4/13/16	MEX-JAGC	WAB	SGI	RELEASED TO PRODUCTION	V09000UD/02

TITLE UNIVERSAL AISLE CONTAINMENT WITH VERTICAL WALLS-V2					
CUSTOMER DRAWING					
ITEM REVISION NAME 15V530AE/01			PANDUIT		
DATASET FILE NAME 15V530AE_DC/01B					
MATERIAL: N/A			DRAWING NUMBER: 15V530AE-DC		
DRAWN BY MEX-JAGC	DATE 4/13/16	CHK WAB	SCALE NONE	SHT 1 OF 8	
					SIZE A

THIS COPY IS PROVIDED ON A RESTRICTED BASIS AND IS NOT TO BE USED IN ANY WAY DETRIMENTAL TO THE INTERESTS OF PANDUIT CORP.

CABINET HEIGHT REQUIREMENTS

SET-UP	MIN CABINET HEIGHT	MAX CABINET HEIGHT
42 RU SET-UP	1956mm (77.0")	2062mm (81.2")
45 RU SET-UP	2089mm (82.2")	2197mm (86.5")
48 RU SET-UP	2223mm (87.5")	2329mm (91.7")
52 RU SET-UP	2400mm (94.5")	2507mm (98.7")

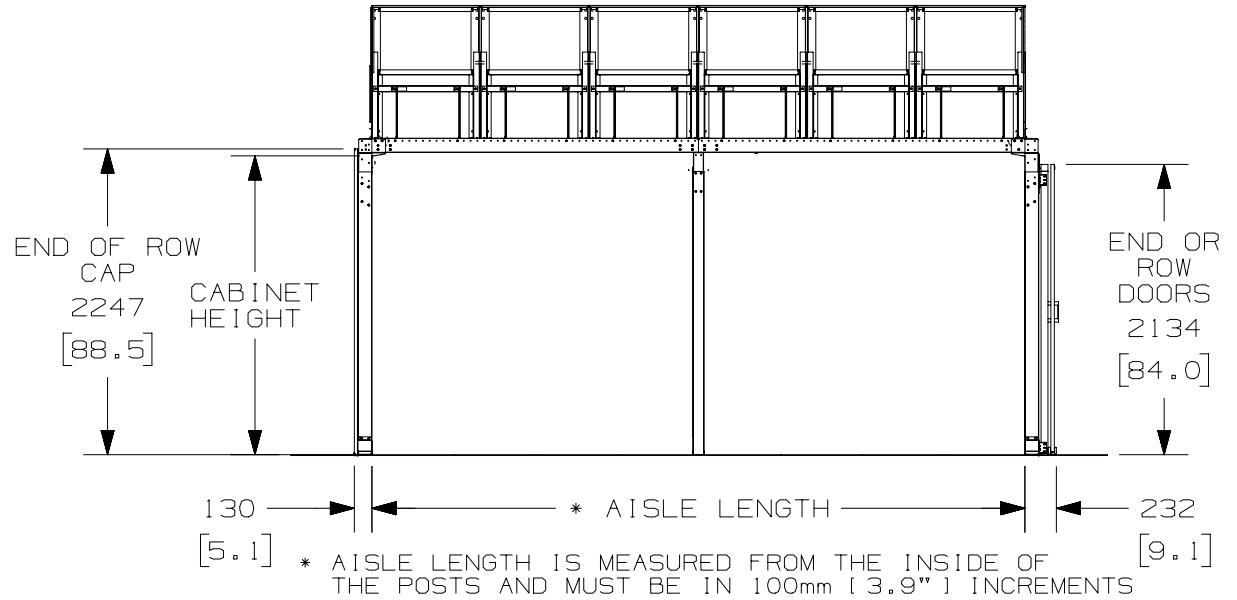

ROOM HEIGHT COMPATIBILITY WHEN USING VERTICAL WALL SECTIONS

VERTICAL WALL STYLE		COMPATIBLE ROOM HEIGHTS USING 42 RU SET-UP	COMPATIBLE ROOM HEIGHTS USING 45 RU SET-UP	COMPATIBLE ROOM HEIGHTS USING 48 RU SET-UP	COMPATIBLE ROOM HEIGHTS USING 52 RU SET-UP
SHORT 406mm - 660mm (16" - 26")	MAX	2850mm (112.2")	2985mm (117.5")	3117mm (122.7")	3294mm (129.7")
	MIN	2596mm (102.2")	2731mm (107.5")	2863mm (112.7")	3040mm (119.7")
MEDIUM 660mm - 965mm (26" - 38")	MAX	3155mm (124.2")	3289mm (129.5")	3421mm (134.7")	3599mm (141.7")
	MIN	2850mm (112.2")	2985mm (117.5")	3117mm (122.7")	3294mm (129.7")
TALL 965mm - 1676mm (38" - 66")	MAX	3866mm (152.2")	4001mm (157.5")	4133mm (162.7")	4310mm (169.7")
	MIN	3155mm (124.2")	3289mm (129.5")	3421mm (134.7")	3599mm (141.7")

TITLE						UNIVERSAL AISLE CONTAINMENT WITH VERTICAL WALLS-V2						
						CUSTOMER DRAWING						
ITEM REVISION NAME						15V530AE/01		PANDUIT				
DATASET FILE NAME						15V530AE_DC/01B						
01B 2/9/21 MEX-JAGC PATR PATR SEE SHEET 1 OF 8 FOR REVISIONS						V09002LE/00		MATERIAL: N/A				
01A 6-7-16 LEE SSP SGI SEE SHEET 1 OF 8 FOR REVISIONS						V09000WR		DRAWING NUMBER: 15V530AE-DC				
00A 4/13/16 MEX-JAGC WAB SGI SEE SHEET 1 OF 8 FOR REVISIONS						V09000UD/02						
REV	DATE	BY	CHK	APR	DESCRIPTION	ECN	DRAWN BY MEX-JAGC	DATE 4/13/16	CHK WAB	SCALE NONE	SHT 2 OF 8	SIZE A

D10100DA/16

THIS COPY IS PROVIDED ON A RESTRICTED BASIS AND IS NOT TO BE USED IN ANY WAY DETRIMENTAL TO THE INTERESTS OF PANDUIT CORP.

2

1

900mm AISLE WIDTH

SLIDING DOOR DIMENSIONS

DOOR IN OPEN POSITION

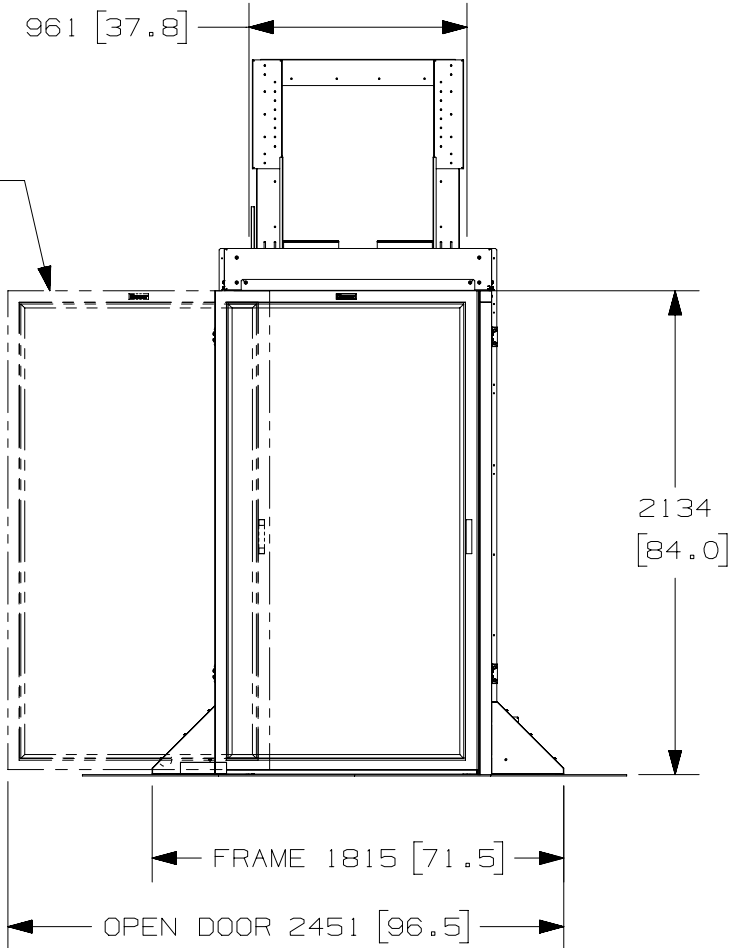

B

B

A

A

TITLE		UNIVERSAL AISLE CONTAINMENT WITH VERTICAL WALLS-V2						
		CUSTOMER DRAWING						
ITEM REVISION NAME		15V530AE/01						
DATASET FILE NAME		15V530AE_DC/01B						
								
		MATERIAL:						
		N/A						
		DRAWING NUMBER:						
		15V530AE-DC						
DRAWN BY	DATE	CHK	SCALE	SIZE				
MEX-JAGC	4/13/16	WAB	NONE	A				
REV		DATE	BY	CHK	APR	DESCRIPTION	ECN	SHT 3 OF 8

01B	2/9/21	MEX-JAGC	PATR	PATR	SEE SHEET 1 OF 8 FOR REVISIONS	V09002LE/00		
01A	7-6-16	LEE	SSP	SGI	SEE SHEET 1 OF 8 FOR REVISIONS	V09000WR		
00A	4/13/16	MEX-JAGC	WABA	SGI	SEE SHEET 1 OF 8 FOR REVISIONS	V09000UD/02		
REV	DATE	BY	CHK	APR	DESCRIPTION	ECN		

2

1

D10100DA/16

THIS COPY IS PROVIDED ON A RESTRICTED BASIS AND IS NOT TO BE USED IN ANY WAY DETRIMENTAL TO THE INTERESTS OF PANDUIT CORP.

SLIDING DOOR DIMENSIONS

1200mm AISLE WIDTH

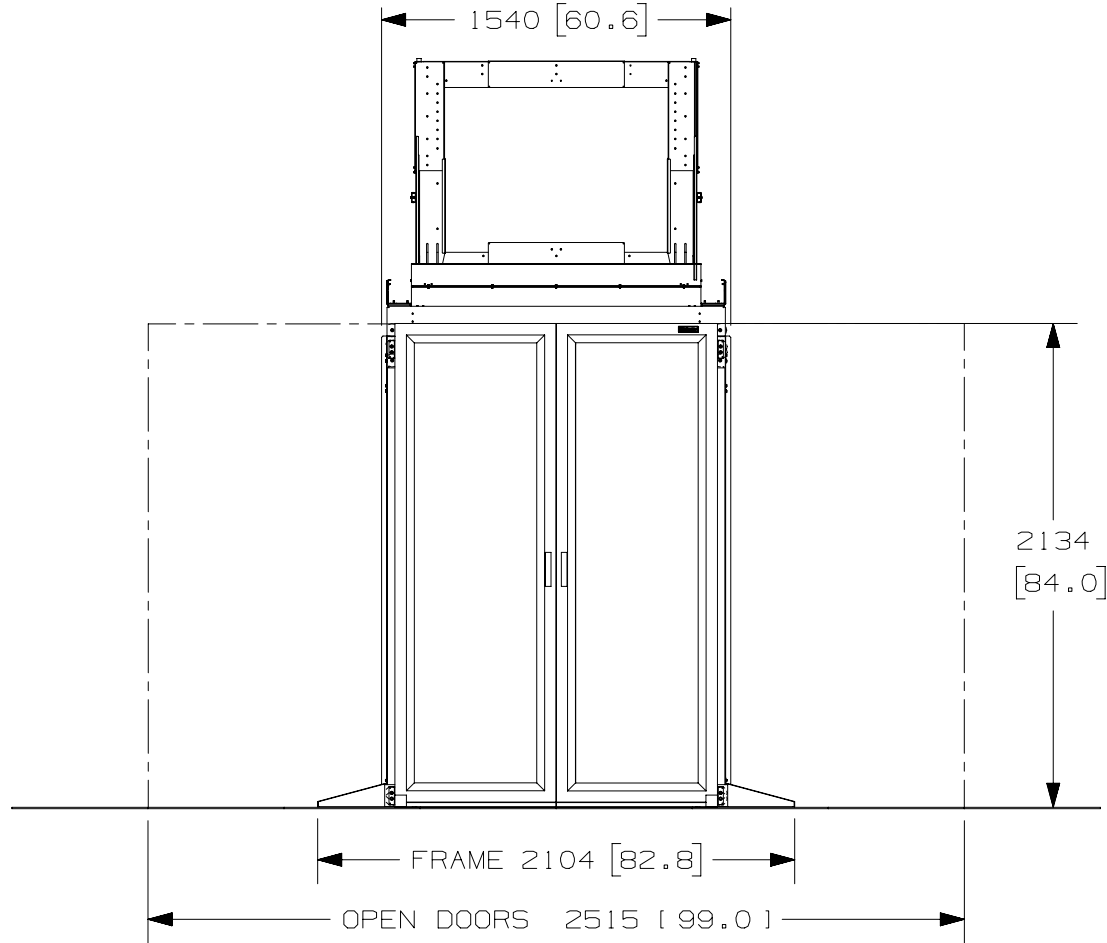

REV	DATE	BY	CHK	APR	DESCRIPTION	ECN
01B	2/9/21	MEX-JAGC	PATR	PATR	SEE SHEET 1 OF 8 FOR REVISIONS	V09002LE/00
01A	7-6-16	LEE	SSP	SGI	SEE SHEET 1 OF 8 FOR REVISIONS	V09000WR
00A	4/13/16	MEX-JAGC	WAB	SGI	SEE SHEET 1 OF 8 FOR REVISIONS	V09000UD/02

TITLE UNIVERSAL AISLE CONTAINMENT WITH VERTICAL WALLS-V2						
CUSTOMER DRAWING						
ITEM REVISION NAME 15V530AE/01					PANDUIT	
DATASET FILE NAME 15V530AE_DC/01B						
MATERIAL: N/A					DRAWING NUMBER: 15V530AE-DC	
DRAWN BY MEX-JAGC	DATE 4/13/16	CHK WAB	SCALE NONE	SHT 4 OF 8		SIZE A

D10100DA/16

THIS COPY IS PROVIDED ON A RESTRICTED BASIS AND IS NOT TO BE USED IN ANY WAY DETRIMENTAL TO THE INTERESTS OF PANDUIT CORP.

NOTES:

1. WALL BEAMS DETERMINE THE TOTAL AISLE LENGTH, FOR EXAMPLE, A 3000mm LONG AISLE WILL REQUIRE 1 PAIR OF 2400mm WALL BEAMS AND 1 PAIR OF 600mm WALL BEAMS.
2. A VERTICAL WALL ADAPTER IS REQUIRED TO MOUNT EACH VERTICAL WALL TO THE WALL BEAMS. THE TOTAL OF THE VERTICAL WALL WIDTHS MUST BE EQUAL TO TWO TIMES THE AISLE LENGTH. FOR EXAMPLE, A 3000mm LONG AISLE WILL REQUIRE 6 800mm AND 2 600mm WIDE VERTICAL WALLS. THE SAME 3000mm LONG AISLE COULD ALSO BE BUILT USING 10 600mm WIDE VERTICAL WALLS.
3. A VERTICAL WALL BRACE IS REQUIRED EVERY 2400mm ALONG THE LENGTH OF THE AISLE. FOR EXAMPLE, A 4800mm LONG AISLE WILL REQUIRE 1 VERTICAL WALL BRACE AND A 7200mm LONG AISLE WILL REQUIRE 2 VERTICAL WALL BRACES.
4. PANDUIT SUGGESTS A MID-SPAN SUPPORT FOR EVERY 2400mm (7.8'). SUPPORT CAN BE PROVIDED BY A MID-SPAN POST OR A MID-SPAN CABINET SUPPORT.
5. FULL HEIGHT BLANKING PANELS ARE 600mm WIDE AND CAN OVERLAP TO ADJUST FOR AISLE LENGTH.
6. ABOVE CABINET BLANKING PANELS ARE USED TO SEAL ABOVE CABINETS THAT ARE SHORTER THAN THE FRAME STRUCTURE.

UNIVERSAL AISLE CONTAINMENT ACCESSORIES

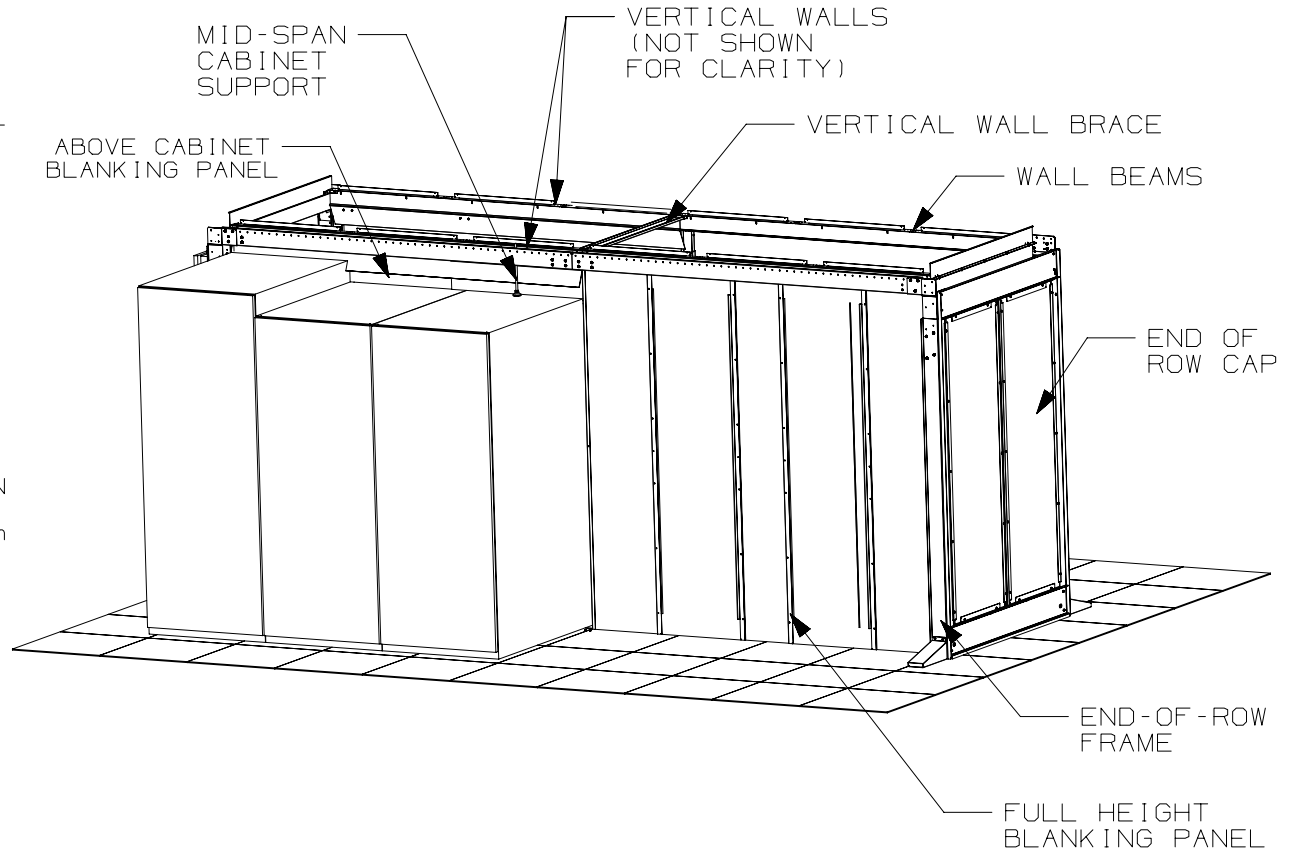

01B	2/9/21	MEX-JAGC	PATR	PATR	SEE SHEET 1 OF 8 FOR REVISIONS	V09002LE/00	
01A	7-6-16	LEE	SSP	SGI	SEE SHEET 1 OF 8 FOR REVISIONS	V09000WR	
00A	4/13/16	MEX-JAGC	WAB	SGI	SEE SHEET 1 OF 8 FOR REVISIONS	V09000UD/02	
REV	DATE	BY	CHK	APR	DESCRIPTION	ECN	

TITLE							UNIVERSAL AISLE CONTAINMENT WITH VERTICAL WALLS-V2	
CUSTOMER DRAWING								
ITEM REVISION NAME							15V530AE/01	
DATASET FILE NAME							15V530AE_DC/01B	
MATERIAL:							N/A	
DRAWING NUMBER:							15V530AE-DC	
DRAWN BY	DATE	CHK	SCALE	SHT 5 OF 8			SIZE	
MEX-JAGC	4/13/16	WAB	NONE				A	

D10100DA/16

THIS COPY IS PROVIDED ON A RESTRICTED BASIS AND IS NOT TO BE USED IN ANY WAY DETRIMENTAL TO THE INTERESTS OF PANDUIT CORP.

<i>END-OF-ROW FRAME PART NUMBERS</i>			
		CONTAINMENT POD AISLE WIDTH	CONTAINMENT POD AISLE WIDTH
		900mm	1200mm
CONTAINMENT POD HEIGHT	42 RU SET-UP	CUSREFRT8xx AND CUEFRCKITxx	CUEFRT8W04xx
	45 RU SET-UP	CUSREFRT8xx AND CUEFRCKITxx	CUEFRT8W04xx
	48 RU SET-UP	CUSREFRT9xx AND CUEFRCKITxx	CUEFRT9W04xx
	52 RU SET-UP	CUSREFRT9xx AND CUEFRCKITxx	CUEFRT9W04xx

<i>WALL BEAM PART NUMBERS</i>				
	600mm	700mm	800mm	2400mm
SINGLE (1 EACH)	CUWBSS06ST01xx	CUWBSS07ST01xx	CUWBSS08ST01xx	CUWBSS24ST01xx
PAIRS (2 EACH)	CUWBPS06ST02xx	CUWBPS07ST02xx	CUWBPS08ST02xx	CUWBPS24ST02xx

NOTE :
 "xx" IN THE PART NUMBER DENOTES COLOR,
 "B1" FOR BLACK AND "W1" FOR WHITE.

<i>END-OF-ROW SLIDING DOORS</i>			
<i>900mm POD AISLE WIDTH</i>		<i>1200mm POD AISLE WIDTH</i>	
RH SINGLE SLIDING DOOR	LH SINGLE SLIDING DOOR	ONE DOOR SET PER PACKAGE	TWO DOOR SETS PER PACKAGE
CUSR1SDRH**	CUSR1SDLH**	CUD1SD**	CUD2SD**

NOTE :
 "***" IN THE PART NUMBER DENOTES COLOR,
 "B1" FOR BLACK AND "S1" FOR SILVER.

REV	DATE	BY	CHK	APR	DESCRIPTION	ECN	TITLE				SIZE	
							UNIVERSAL AISLE CONTAINMENT WITH VERTICAL WALLS-V2				A	
							CUSTOMER DRAWING					
							ITEM REVISION NAME		15V530AE/01		PANDUIT	
							DATASET FILE NAME		15V530AE_DC/01B			
01B	2/9/21	MEX-JAGC	PATR	PATR	SEE SHEET 1 OF 8 FOR REVISIONS	V09002LE/00	MATERIAL: N/A					
01A	7-6-16	LEE	SSP	SGI	SEE SHEET 1 OF 8 FOR REVISIONS	V09000WR						
00A	4/13/16	MEX-JAGC	WAB	SGI	SEE SHEET 1 OF 8 FOR REVISIONS	V09000UD/02						
							DRAWING NUMBER: 15V530AE-DC					
							DRAWN BY	DATE	CHK	SCALE	SHT 6 OF 8	A
							MEX-JAGC	4/13/16	WAB	NONE		

D110100DA/16

THIS COPY IS PROVIDED ON A RESTRICTED BASIS AND IS NOT TO BE USED IN ANY WAY DETRIMENTAL TO THE INTERESTS OF PANDUIT CORP.

2

1

VERTICAL WALL ADAPTERS			
		900mm	1200mm
VERTICAL WALL WIDTH	600mm	CUSRVWA06xx	CUVWA06S06STxx
	700mm	CUSRVWA07xx	CUVWA07S07STxx
	800mm	CUSRVWA08xx	CUVWA08S08STxx

VERTICAL WALL BRACES
CUVWB12S12STxx

VERTICAL WALLS				
		HEIGHT ADJUSTMENT RANGE		
		16" - 26"	26" - 38"	38" - 66"
VERTICAL WALL WIDTH	600mm	C2HAC06I1626**	C2HAC06I2638xx	C2HAC06I3866xx
	700mm	C2HAC07I1626**	C2HAC07I2638xx	C2HAC07I3866xx
	800mm	C2HAC08I1626**	C2HAC08I2638xx	C2HAC08I3866xx

END-OF-ROW VERTICAL WALLS			
		900mm	1200mm
HEIGHT ADJUSTMENT RANGE	16" - 26"	CUSRVWER1626xx	C2HACERI1626xx
	26" - 38"	CUSRVWER2638xx	C2HACERI2638xx
	38" - 66"	CUSRVWER3866xx	C2HACERI3866xx

NOTE :
 "xx" IN THE PART NUMBER DENOTES COLOR,
 "B1" FOR BLACK AND "W1" FOR WHITE.

REV	DATE	BY	CHK	APR	DESCRIPTION	ECN	TITLE	DRAWN BY	DATE	CHK	SCALE	DRAWING NUMBER	SIZE			
							UNIVERSAL AISLE CONTAINMENT WITH VERTICAL WALLS-V2									
							CUSTOMER DRAWING									
							ITEM REVISION NAME									
							15V530AE/01									
							DATASET FILE NAME									
							15V530AE_DC/01B									
01B	2/9/21	MEX-JAGC	PATR	PATR	SEE SHEET 1 OF 8 FOR REVISIONS	V09002LE/00	 MATERIAL: N/A DRAWING NUMBER: 15V530AE-DC									
01A	7-6-16	LEE	SSP	SGI	SEE SHEET 1 OF 8 FOR REVISIONS	V09000WR										
00A	4/13/16	MEX-JAGC	WAB	SGI	SEE SHEET 1 OF 8 FOR REVISIONS	V09000UD/02										
							DRAWN BY	MEX-JAGC	DATE	4/13/16	CHK	WAB	SCALE	NONE	SHT 7 OF 8	A

2

1

D10100DA/16

THIS COPY IS PROVIDED ON A RESTRICTED BASIS AND IS NOT TO BE USED IN ANY WAY DETRIMENTAL TO THE INTERESTS OF PANDUIT CORP.

FULL HEIGHT BLANKING PANELS		
CONTAINMENT POD HEIGHT	42 RU SET-UP	CUFBPR4206HBxx
	45 RU SET-UP	CUFBPR4506HBxx
	48 RU SET-UP	CUFBPR4806HBxx
	52 RU SET-UP	CUFBPR5206HBxx

ABOVE CABINET BLANKING PANEL
CUTBPR0610HBN1

MID-SPAN SUPPORT POST
CUSMPR52ST01xx

MID-SPAN CABINET SUPPORT	
300mm	CUCMSS03ST01NC
600mm	CUCMSS06ST01NC

NOTE :
 "xx" IN THE PART NUMBER DENOTES COLOR,
 "B1" FOR BLACK AND "W1" FOR WHITE.

B

B

A

A

D10100DA/16

REV	DATE	BY	CHK	APR	DESCRIPTION	ECN	TITLE				SIZE	
							UNIVERSAL AISLE CONTAINMENT WITH VERTICAL WALLS-V2					
							CUSTOMER DRAWING					
							ITEM REVISION NAME		15V530AE/01		PANDUIT	
							DATASET FILE NAME		15V530AE_DC/01B			
01B	2/9/21	MEX-JAGC	PATR	PATR	SEE SHEET 1 OF 8 FOR REVISIONS	V09002LE/00					MATERIAL:	
01A	7-6-16	LEE	SSP	SGI	SEE SHEET 1 OF 8 FOR REVISIONS	V09000WR					N/A	
00A	4/13/16	MEX-JAGC	WAB	SGI	SEE SHEET 1 OF 8 FOR REVISIONS	V09000UD/02					DRAWING NUMBER:	
											15V530AE-DC	
							DRAWN BY	DATE	CHK	SCALE		
							MEX-JAGC	4/13/16	WAB	NONE		
											SHT 8 OF 8	A