

THIS COPY IS PROVIDED ON A RESTRICTED BASIS AND IS NOT TO BE USED IN ANY WAY DETRIMENTAL TO THE INTERESTS OF PANDUIT CORP.

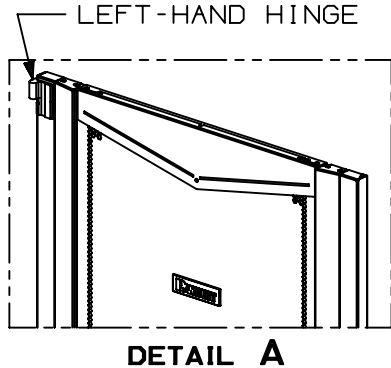
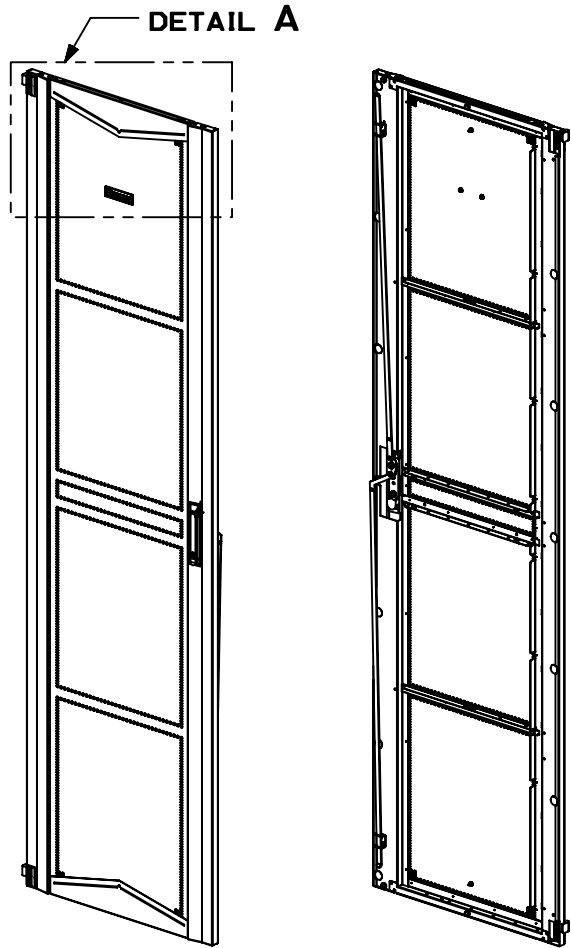

- NOTES:
1. VISIT OUR ON-LINE CATALOG AT WWW.PANDUIT.COM FOR A LIST OF CURRENT PARTS APPLICABLE FOR USE WITH THIS PRODUCT.
 2. PRIMARY DIMENSIONS ARE IN MILLIMETERS.
 3. PARTS SUPPLIED:

- PARTS SUPPLIED (LEFT):
- (1) LEFT-HAND HINGING ODF DOOR
 - (4) #12-24 MOUNTING SCREWS
 - (4) #12 EXTERNAL TOOTH WASHERS

- PARTS SUPPLIED (RIGHT):
- (1) RIGHT-HAND HINGING ODF DOOR
 - (4) #12-24 MOUNTING SCREWS
 - (4) #12 EXTERNAL TOOTH WASHERS

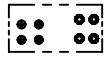

PARTS SUPPLIED
(SEE NOTE 3)

LEFT-HAND HINGING DOOR

ISO VIEW - FRONT ISO VIEW - REAR

| 02A | 8/23/21 | LEE | MCIS | ANJA & GB-SJMO | DRAWING RELEASE | | | V09002TW/07 |
|-----|---------|-----|------|----------------|-----------------|--|--|-------------|
| REV | DATE | BY | CHK | APR | DESCRIPTION | | | ECN |

| | | | |
|------------------------|---------|--|-------|
| TITLE | | ODF SINGLE HINGE FRONT DOOR (FDUFD6045PR** & FDUFD6045PL**) | |
| | | CUSTOMER DRAWING | |
| ITEM REVISION NAME | | 00676EAS/02 | |
| DATASET FILE NAME | | 00676EAS_DC/02A | |
| MATERIAL | | N/A | |
| DRAWING NUMBER | | 00676EAS_DC | |
| THIRD ANGLE PROJECTION | | | |
| DRAWN BY | DATE | CHK | SCALE |
| LEE | 8/23/21 | MCIS | NONE |
| SHT 1 OF 3 | | A | |

XGLOBAL_ASIZE

2

1

THIS COPY IS PROVIDED ON A RESTRICTED BASIS AND IS NOT TO BE USED IN ANY WAY DETRIMENTAL TO THE INTERESTS OF PANDUIT CORP.

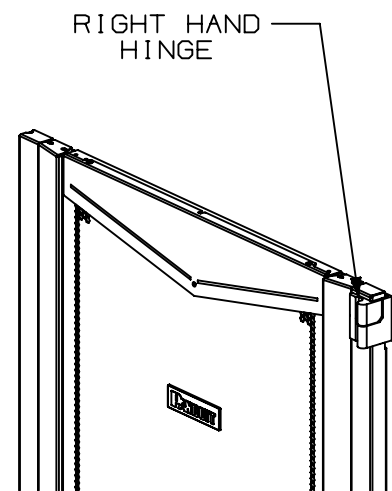
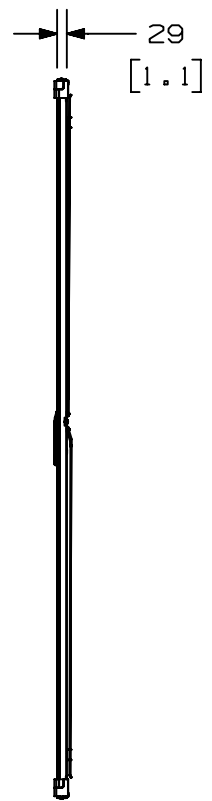
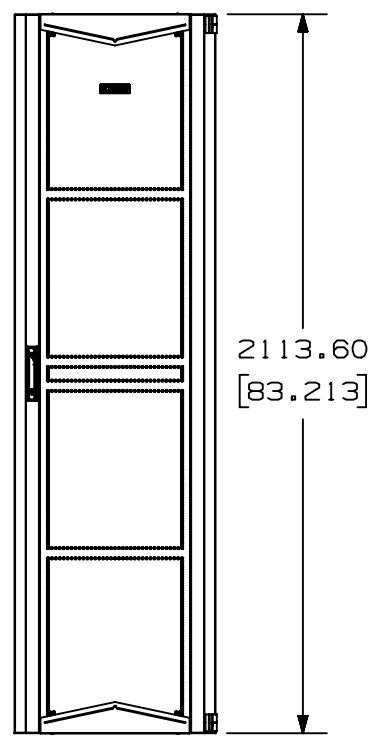
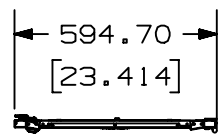

DETAIL B

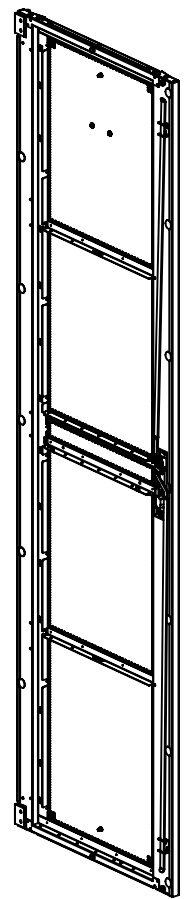
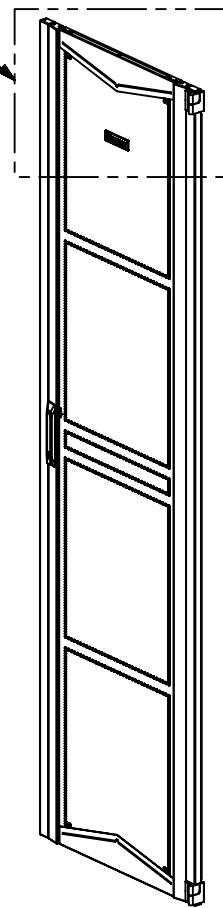

RIGHT-HAND HINGING DOOR

ISO VIEW - FRONT

ISO VIEW - REAR

A

A

| | | | | |
|------------------------|---------|--|-------|------------|
| TITLE | | ODF SINGLE HINGE FRONT DOOR (FDUFD6045PR** & FDUFD6045PL**) | | |
| ITEM REVISION NAME | | CUSTOMER DRAWING | | |
| DATASET FILE NAME | | 00676EAS/02 | | |
| | | 00676EAS_DC/02A | | |
| MATERIAL | | N/A | | |
| DRAWING NUMBER | | 00676EAS_DC | | |
| THIRD ANGLE PROJECTION | | | | |
| DRAWN BY | DATE | CHK | SCALE | SHT 2 OF 3 |
| LEE | 8/23/21 | MCIS | NONE | A |

| 02A | 8/23/21 | LEE | MCIS | ANJA & GB-SJMO | DRAWING RELEASE | V09002TW/07 |
|-----|---------|-----|------|----------------|-----------------|-------------|
| REV | DATE | BY | CHK | APR | DESCRIPTION | ECN |

2

1

NXGLOBAL_ASIZE

2

1

THIS COPY IS PROVIDED ON A RESTRICTED BASIS AND IS NOT TO BE USED IN ANY WAY DETRIMENTAL TO THE INTERESTS OF PANDUIT CORP.

| PART NO. | DESCRIPTION | WEIGHT |
|---------------|---|----------------------|
| FDUFD6045PLGY | ODF FRONT DOOR, 600mm WIDE, 45RU TALL, PERFORATED, LEFT HINGING, GREY | 11.97 Kg 26.4 lbs |
| FDUFD6045PLBL | ODF FRONT DOOR, 600mm WIDE, 45RU TALL, PERFORATED, LEFT HINGING, BLACK | |
| FDUFD6045PRGY | ODF FRONT DOOR, 600mm WIDE, 45RU TALL, PERFORATED, RIGHT HINGING, GREY | |
| FDUFD6045PRBL | ODF FRONT DOOR, 600mm WIDE, 45RU TALL, PERFORATED, RIGHT HINGING, BLACK | |

B

B

A

A

GLOBAL-ASIZE

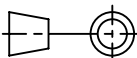
| | | | | | | | | | | | | |
|-----|---------|-----|------|----------------|-----------------|---|---|-----------------|---|---------------|------------|-----------|
| | | | | | | | TITLE ODF SINGLE HINGE FRONT DOOR (FDUFD6045PR** & FDUFD6045PL**) | | | | | |
| | | | | | | | CUSTOMER DRAWING | | | | | |
| | | | | | | | ITEM REVISION NAME 00676EAS/02 | |  | | | |
| | | | | | | DATASET FILE NAME 00676EAS_DC/02A | | | | | | |
| | | | | | | | MATERIAL N/A | | | | | |
| 02A | 8/23/21 | LEE | MCIS | ANJA & GB-SJMO | DRAWING RELEASE | V09002TW/07 |  | | DRAWING NUMBER 00676EAS_DC | | | |
| REV | DATE | BY | CHK | APR | DESCRIPTION | ECN | DRAWN BY LEE | DATE 8/23/21 | CHK MCIS | SCALE NONE | SHT 3 OF 3 | SIZE A |

2

1