



Sammode

Pauli 133 HT 200

Notice de montage

Mounting instruction

Montageanleitung

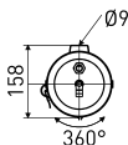
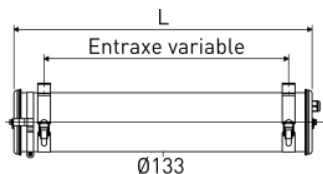
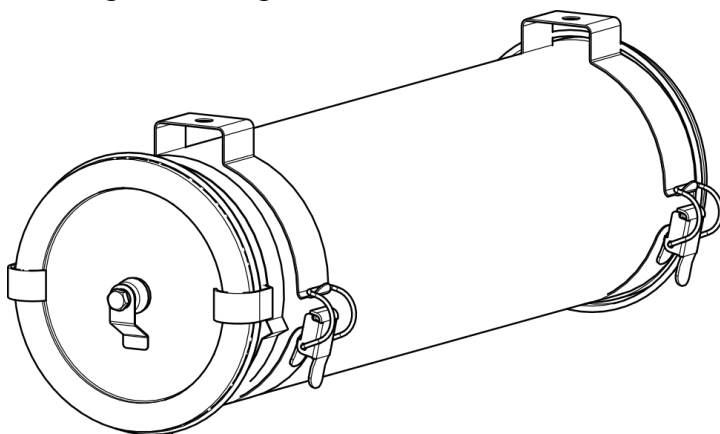

Ne pas ouvrir sous tension
Do not open when energized
Nicht unter Spannung öffnen

Type	L	Entraxe max
	(mm)	(mm)
1x60 W	464	368
2x60 W	677	583

Installation & raccordement / Wiring / Verkabelung

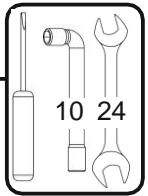

1.

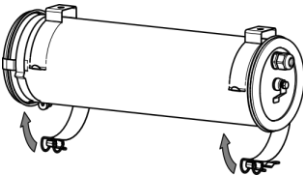

2.

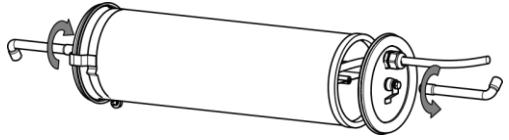

3.

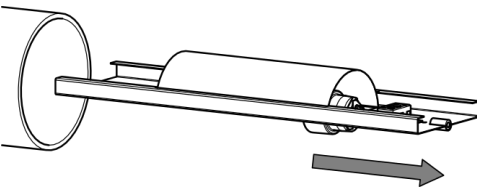

4.

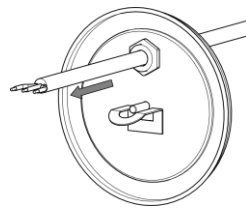

5.

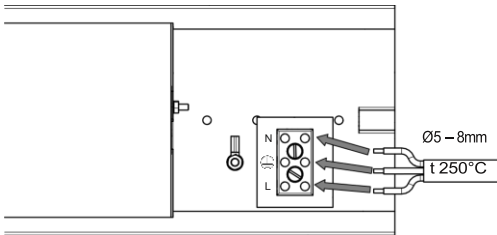

6.

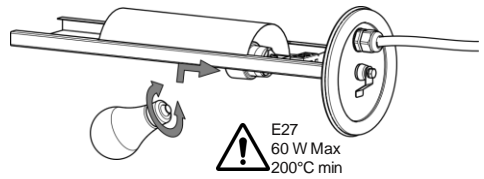

7.

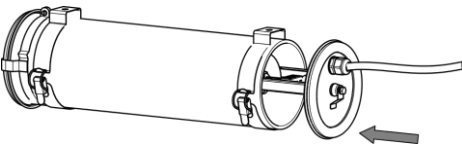

8.

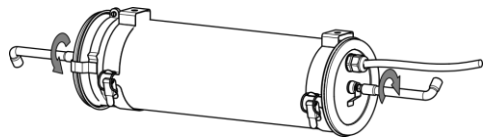

9.

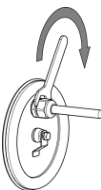

Maintenance

Maintenance / Wartung

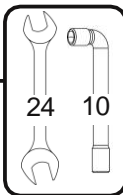

Ne pas ouvrir sous tension
Do not open when energized
Nicht unter Spannung öffnen

1.

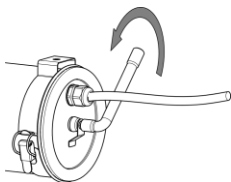

2.

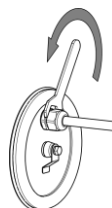

3.

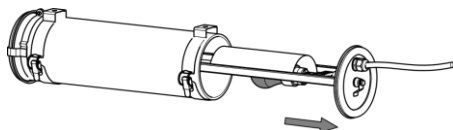

4.

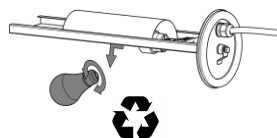

5.

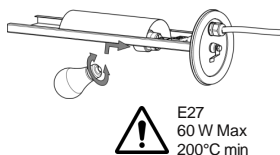

6.

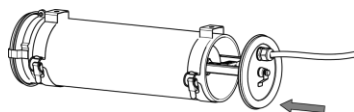

7.

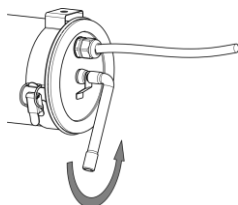

8.

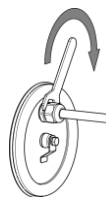

Instructions

Mounting instructions

Montageanweisungen

1. Position & câble / Position & cable / Position & Kabel

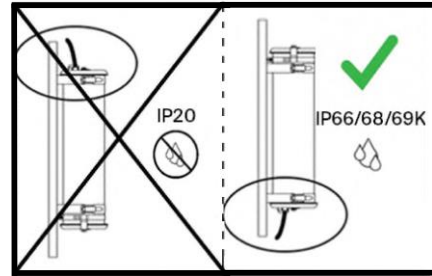
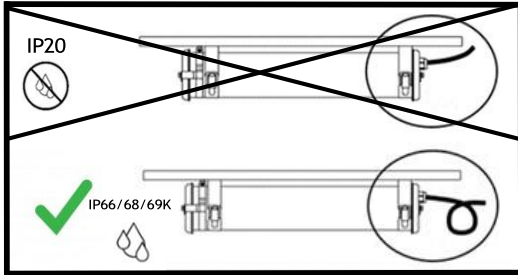

Vérifier impérativement la correcte fermeture des organes d'étanchéité du produit, y compris pour les produits livrés précâblés.

Make sure to check that all sealing elements are correctly in place and closed, even for light fittings delivered pre-cabled.

Die richtige Verschließung der Dichtungselemente unbedingt überprüfen, auch bei Leuchten, die vorverkabelt geliefert sind.

2. Flasques / End caps / Endkappen

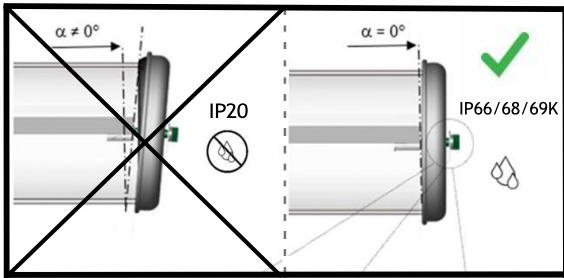

3. Vis centrale / Central screw / Zentrale Schraube

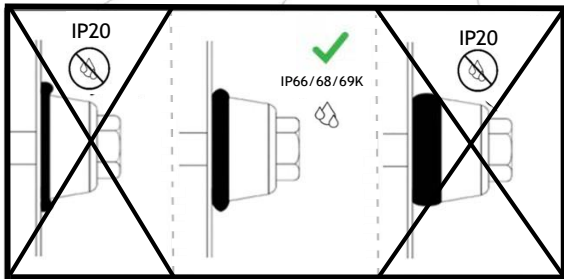

Conditions d'entretien de l'inox : voir la FAQ du site Sammode

Conditions for maintaining stainless steel: see the FAQ on the Sammode website

Bedingungen für die Pflege von Edelstahl: siehe FAQ auf der Sammode-Website