

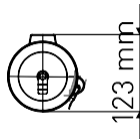

Sammode  
Studio

# Musset GR

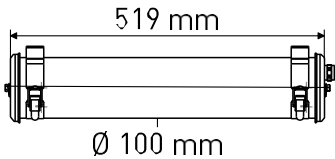
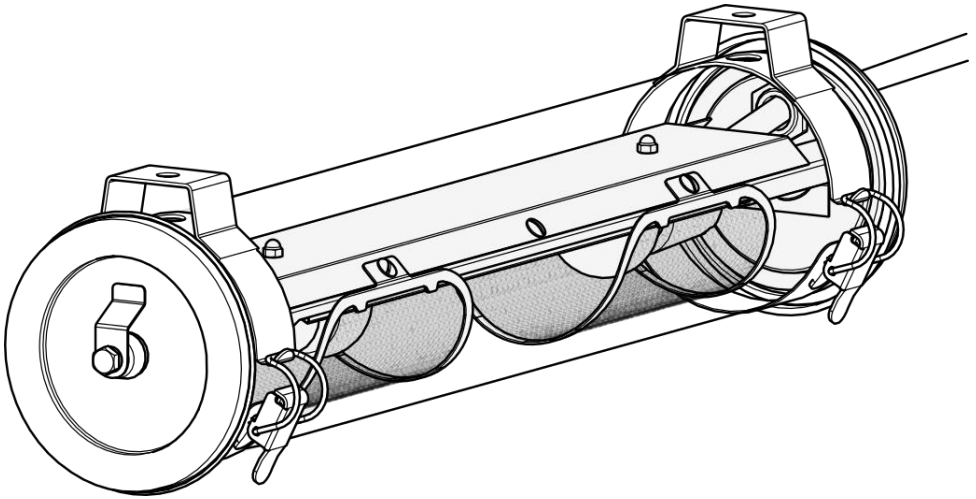

# Montage

Mounting / Montage

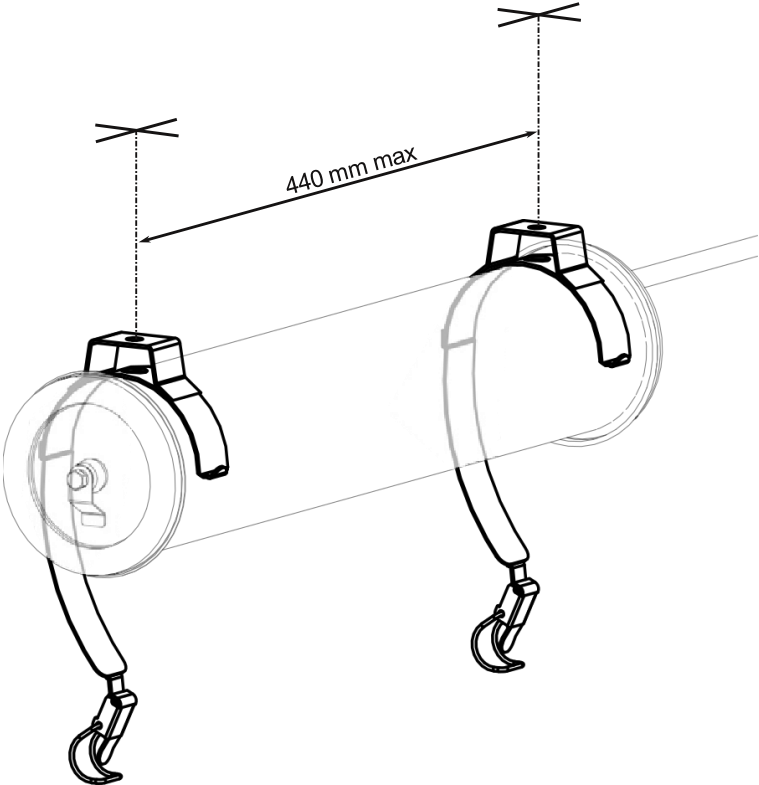

# Changement de lampe

Change the lamp / Lampenwechsel

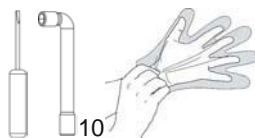

Les lampes fournies par Sammode permettent un fonctionnement optimal du produit.  
En cas de remplacement, nous recommandons l'utilisation de modèles strictement équivalents.

Lamps are provided by Sammode for an optimal functioning.  
In case of relamping, we highly recommend the use of similar lamps.

Der besten Betrieb der Leuchten wird mit von Sammode gelieferten Leuchtmittel geprüft.  
Beim Austausch der Leuchtmittel empfehlen wir ähnliche Leuchtmittel zu verwenden.



**Ne pas ouvrir sous tension**  
**Do not open when energized**  
**Nicht unter Spannung öffnen**

1.

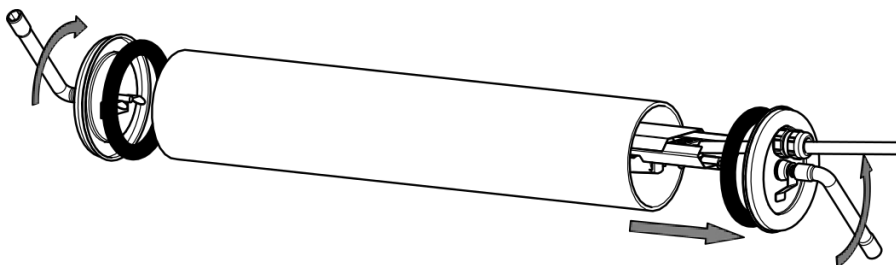

2.

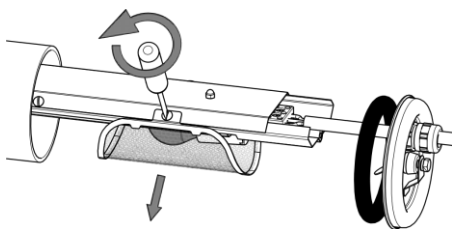

3.

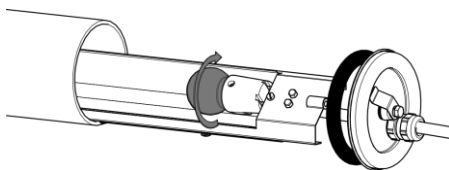

4.

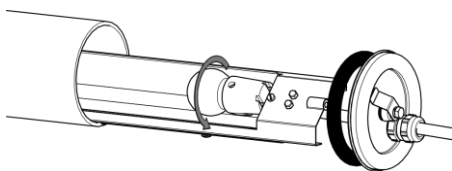

5.

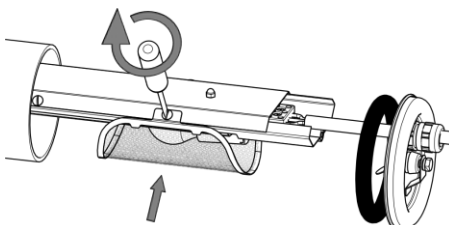

5.

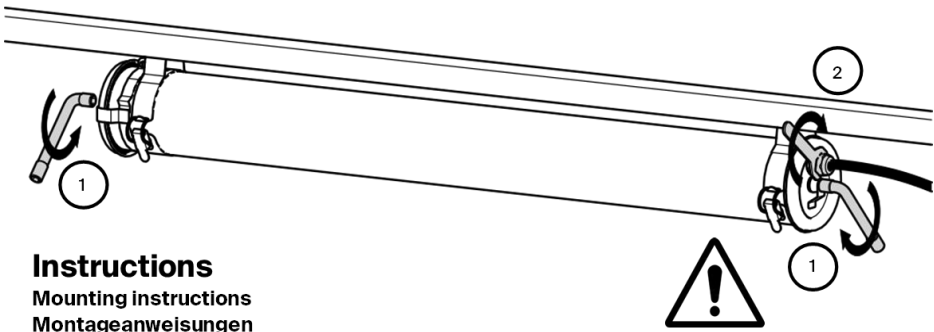

## Instructions

Mounting instructions  
Montageanweisungen

### 1. Position & câble / Position & cable / Position

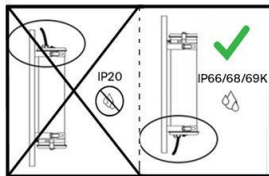
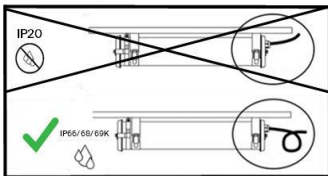

Vérifier impérativement la correcte fermeture des organes d'étanchéité du produit, y compris pour les produits livrés précâblés.

Make sure to check that all sealing elements are correctly in place and closed, even for light fittings delivered pre-cabled.

Die richtige Verschiebung der Dichtungselemente unbedingt überprüfen, auch bei Leuchten, die vorverkabelt geliefert sind.

### 2. Flasques / End caps / Endkappen

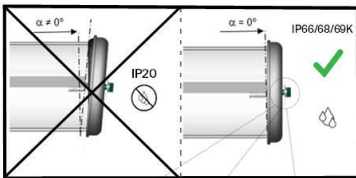

### 3. Vis centrale / Central screw / Zentrale Schraube

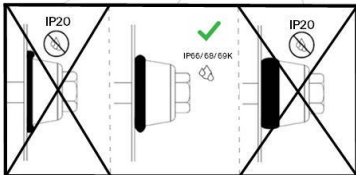

Conditions d'entretien de l'inox : voir la FAQ du site Sammode

Conditions for maintaining stainless steel: see the FAQ on the Sammode website

Bedingungen für die Pflege von Edelstahl: siehe FAQ auf der Sammode-Website