



# Sammode

Éclairage technique depuis 1927

## Pauli 133 HT 200

### Notice de montage

Mounting instruction

Montageanleitung

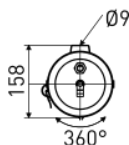
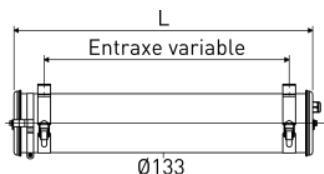
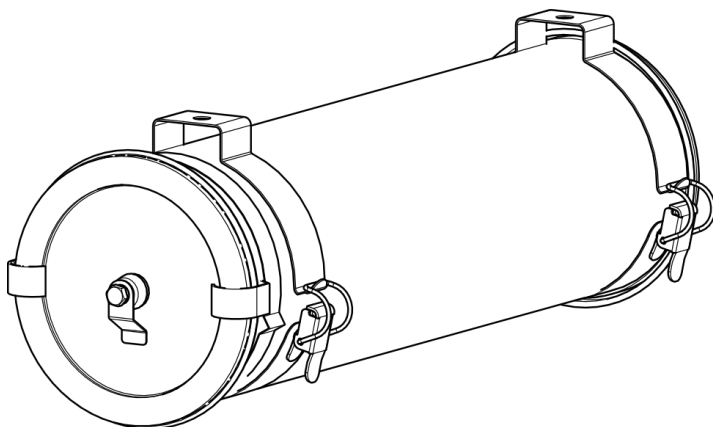

Ne pas ouvrir sous tension  
Do not open when energized  
Nicht unter Spannung öffnen

Type	L	Entraxe max
	(mm)	(mm)
1x60 W	464	368
2x60 W	677	583

# Installation & raccordement / Wiring / Verkabelung

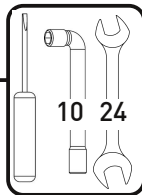

1.

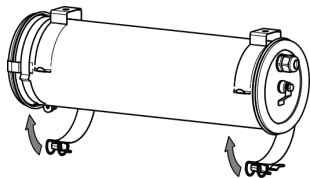

2.

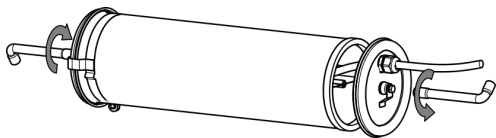

3.

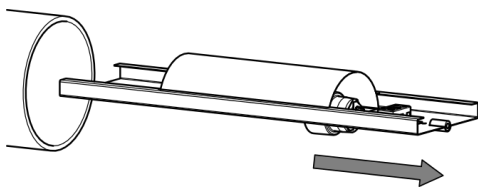

4.

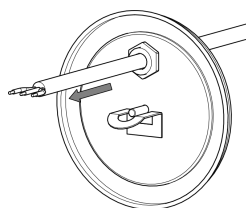

5.

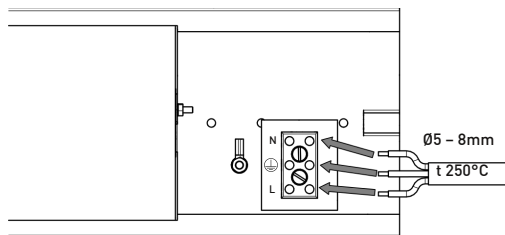

6.

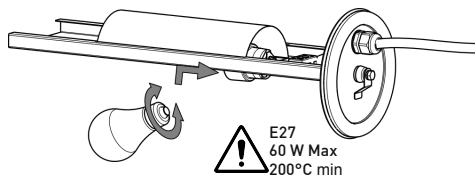

7.

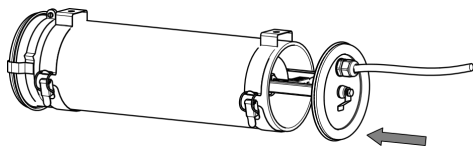

8.

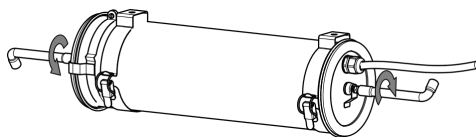

9.

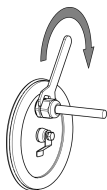

# Maintenance

Maintenance / Wartung

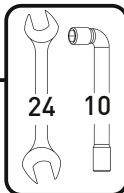

Ne pas ouvrir sous tension  
Do not open when energized  
Nicht unter Spannung öffnen

1.

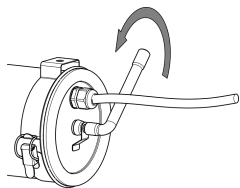

2.

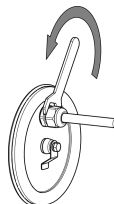

3.

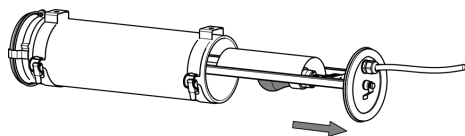

4.

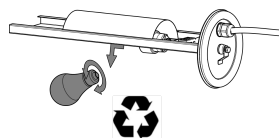

5.

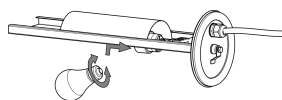

6.

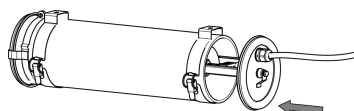

 E27  
60 W Max  
200°C min

7.

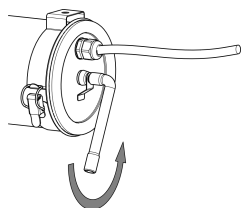

8.

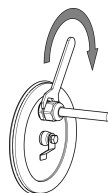

## 1. Position & câble / Position & cable / Position & Kabel

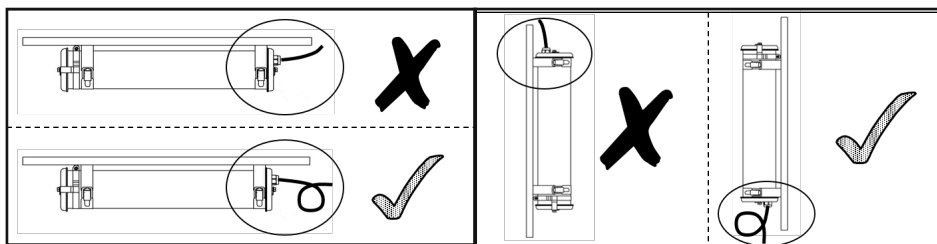

## 2. Flasques / End caps / Endkappen

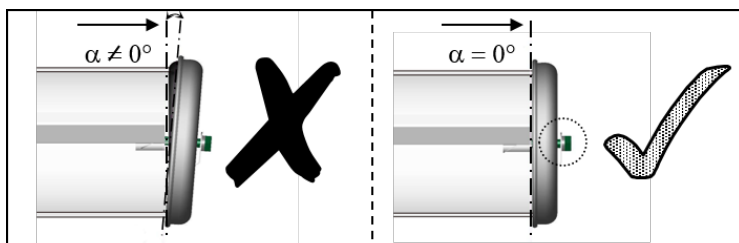

## 3. Vis centrale / Central screw / Zentrale Schraube

