

### REFERENCES PRODUITS

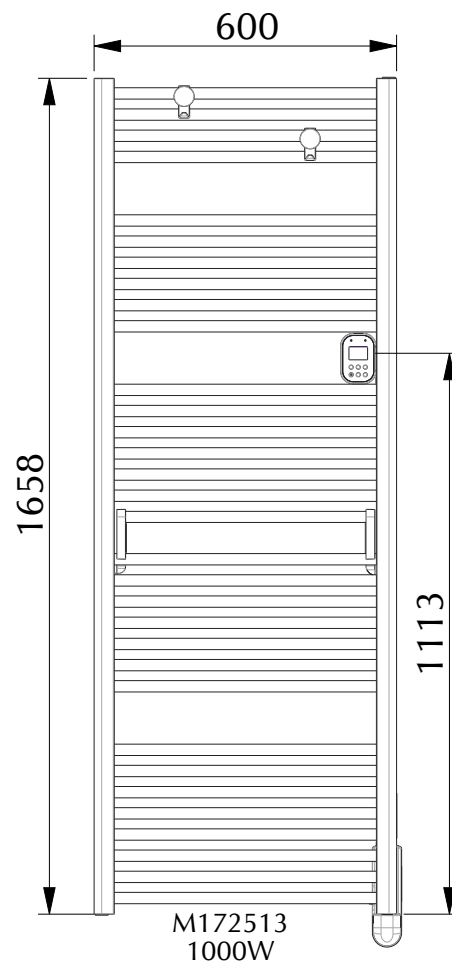

### PIECES DETACHEES

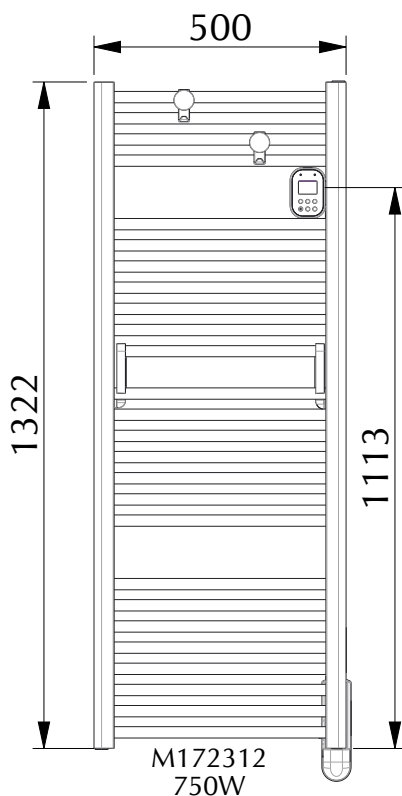
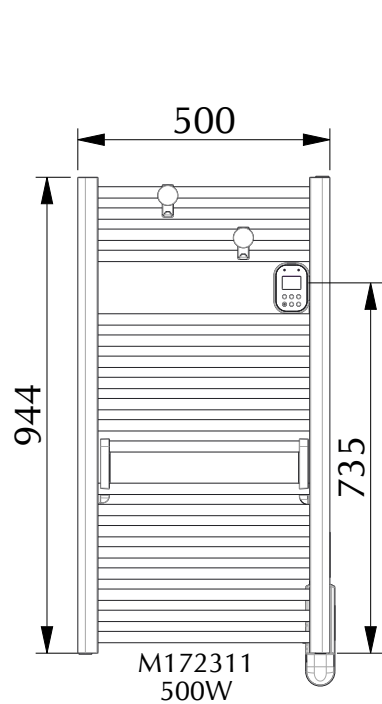
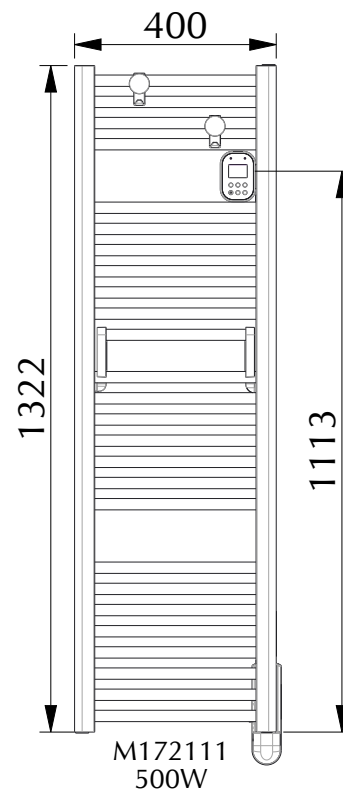
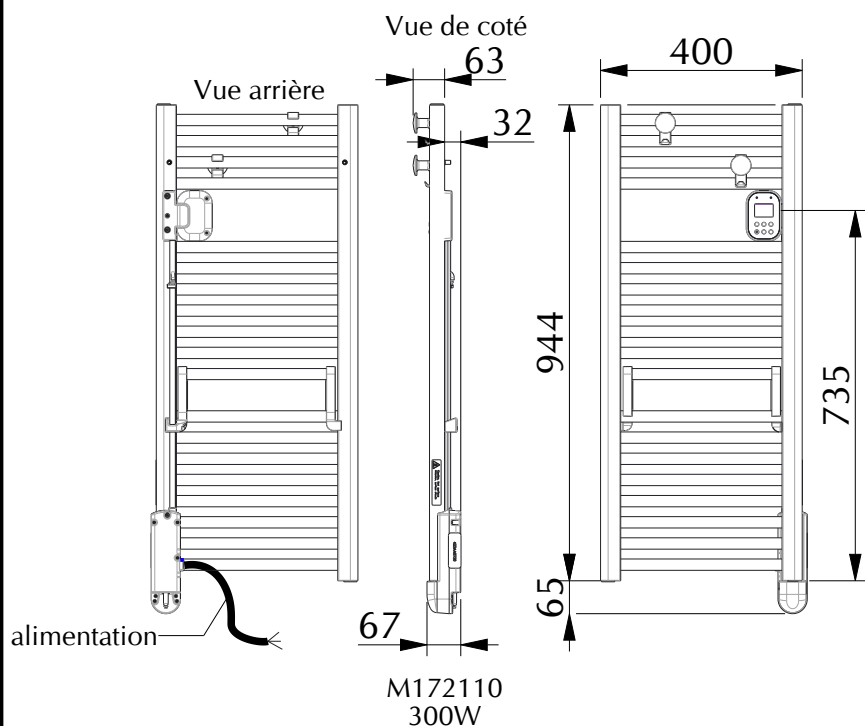
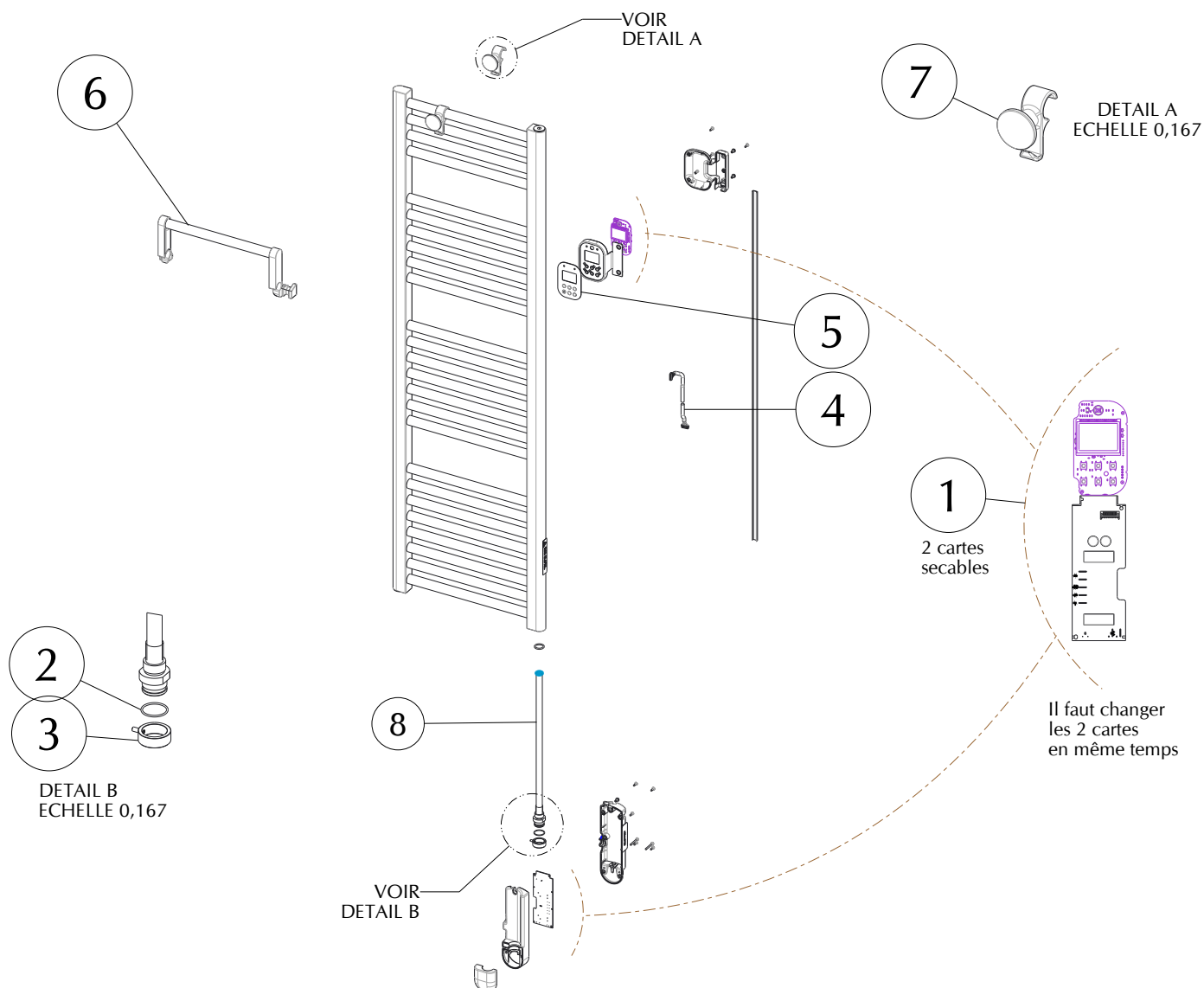

REPERE	REFERENCE	DESIGNATION	APPAREIL
1	S131AA3032B	thermostat + carte de commande (2 cartes sécables)	commun
2	S142JJ0193	joint silicone Ø22 tore1.5	commun
3	S30FAA3624	bague de centrage + vis pointeau M4X12	commun
4	S242AA5298	cordon de liaison 8 fils LG 680 mm	M172110
	S242AA5299	cordon de liaison 8 fils LG 1060 mm	M172111
	S242AA5298	cordon de liaison 8 fils LG 680 mm	M172311
	S242AA5299	cordon de liaison 8 fils LG 1060 mm	M172312
	S242AA5299	cordon de liaison 8 fils LG 1060 mm	M172513
5	S423BB8823	plastron de commande	commun
6	S44FAA0042EC	ensemble barre pour appareil Larg 400 mm	M172110
	S44FAA0042EC	ensemble barre pour appareil Larg 400 mm	M172111
	S44FAA0043EC	ensemble barre pour appareil Larg 500 mm	M172311
	S44FAA0043EC	ensemble barre pour appareil Larg 500 mm	M172312
	S44FAA0044EC	ensemble barre pour appareil Larg 600 mm	M172513
7	S321CC0532FS	patère à clipée x1	commun
8	S113BGA003	thermo-plongeur (cartouche fluide) 300W	M172110
	S113CCA022	thermo-plongeur (cartouche fluide) 500W	M172111
	S113CCA022	thermo-plongeur (cartouche fluide) 500W	M172311
	S113DDA199	thermo-plongeur (cartouche fluide) 750W	M172312
	S113EEA218	thermo-plongeur (cartouche fluide) 1000W	M172513

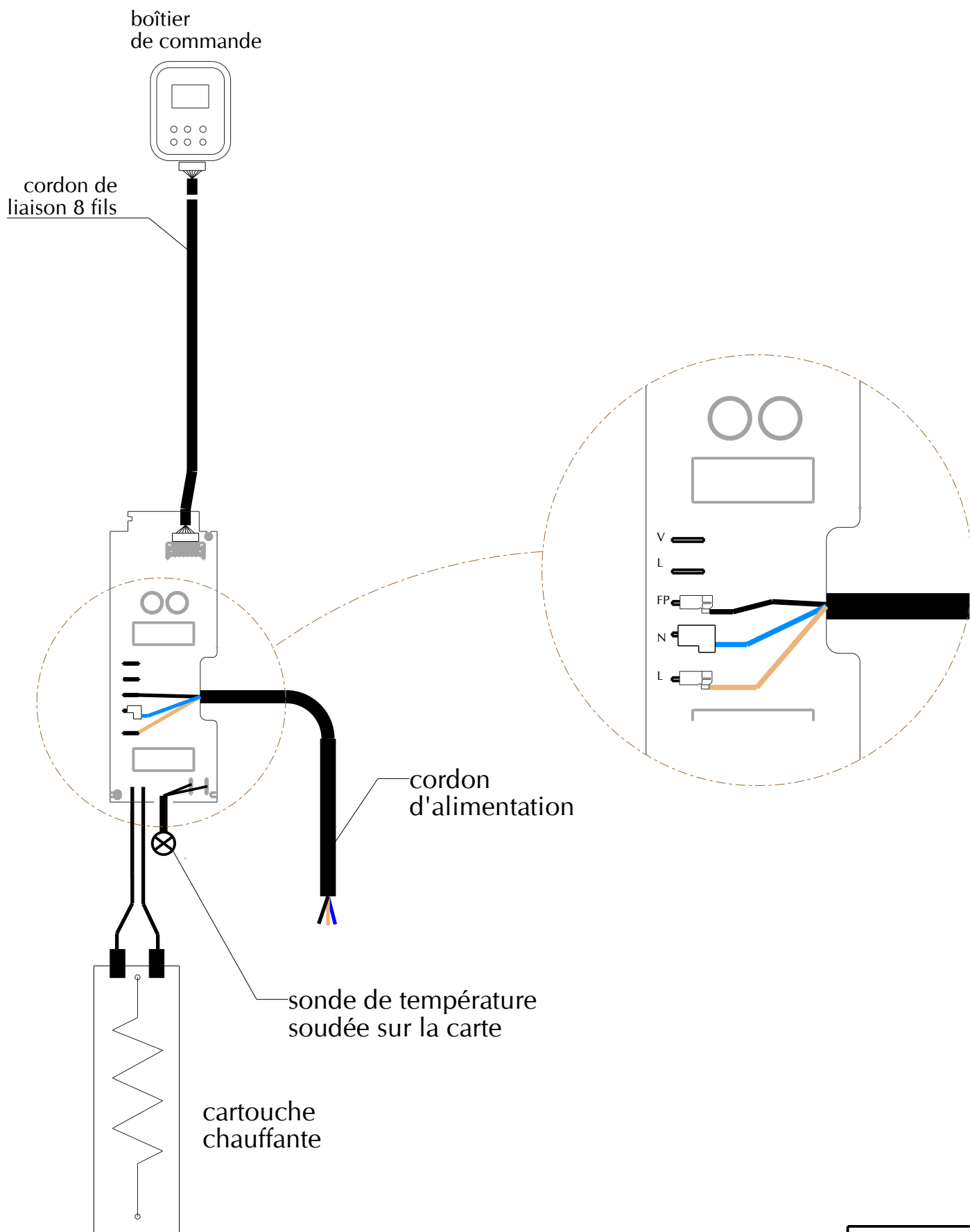

INDICE	MODIFICATION	DATE	AUTEUR