

Compact	NSX 400/630	3P/4P
Easypact	CVS 400/630	3P/4P
Compact	NSX Vigi 400/630 (ELCB)	3P/4P
Easypact	Vigi CVS 400/630	3P/4P
Compact	Vigi NSX 400/630	3P/4P
Compact	INS-INV 320/630	3P/4P
PowerTag	NSX 400/630	3P/4P
PowerTag	NSX Vigi 400/630 (ELCB)	3P/4P
PowerTag	INS-INV 320/630	3P/4P

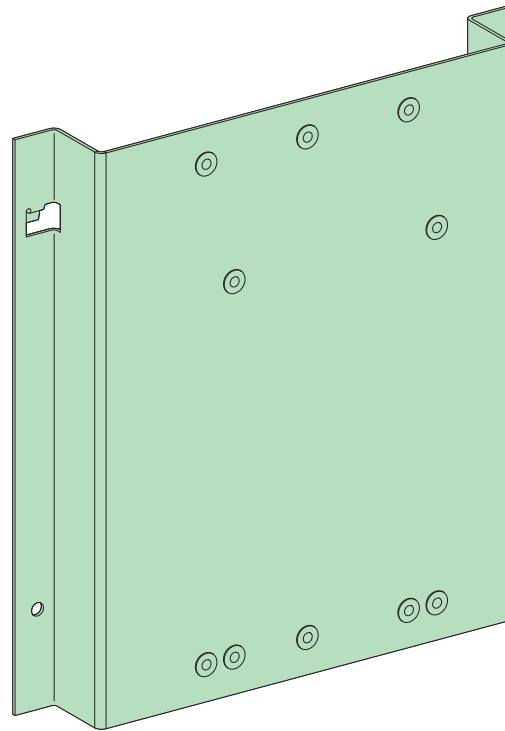
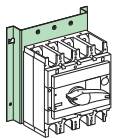

x2

**PLEASE NOTE**

Electrical equipment should be installed, operated, serviced, and maintained only by qualified personnel. No responsibility is assumed by Schneider Electric for any consequences arising out of the use of this material.

NOTA

Manutenzione, riparazione, installazione e uso delle apparecchiature elettriche si devono affidare solo a personale qualificato. Schneider Electric non si assume alcuna responsabilità per qualsiasi conseguenza derivante dall'uso di questo materiale.

REMARQUE IMPORTANTE

L'installation, l'utilisation, la réparation et la maintenance des équipements électriques doivent être assurées par du personnel qualifié uniquement. Schneider Electric décline toute responsabilité quant aux conséquences de l'utilisation de ce matériel.

NOTA

A instalação, utilização e manutenção do equipamento eléctrico devem ser efectuadas exclusivamente por pessoal qualificado. A Schneider Electric não assume qualquer responsabilidade pelas consequências resultantes da utilização deste material.

TENGA EN CUENTA

La instalación, manejo, puesta en servicio y mantenimiento de equipos eléctricos deberán ser realizados sólo por personal cualificado. Schneider Electric no se hace responsable de ninguna de las consecuencias del uso de este material.

请注意

电气设备的安装、操作、维修和维护工作仅限于合格人员执行。Schneider Electric 不承担由于使用本资料所引起的任何后果。

BITTE BEACHTEN

Elektrische Geräte dürfen nur von Fachpersonal installiert, betrieben, bedient und gewartet werden. Schneider Electric haftet nicht für Schäden, die durch die Verwendung dieses Materials entstehen.

ОБРАТИТЕ ВНИМАНИЕ

Установка, эксплуатация, ремонт и обслуживание электрического оборудования может выполняться только квалифицированными электриками. Компания Schneider Electric не несет никакой ответственности за любые возможные последствия использования данной документации.

A

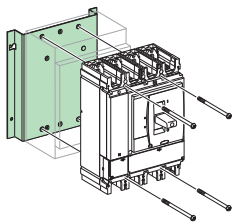

NSX 400/630
 NSX Vigi 400/630 (ELCB)
 Vigi NSX 400/630
 PowerTag NSX 400/630
 PowerTag NSX Vigi 400/630 (ELCB)
 CVS 400/630
 Vigi CVS 400/630

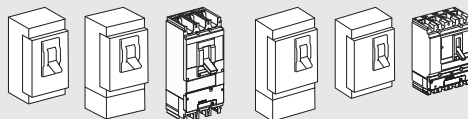

3P

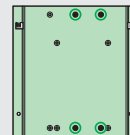

4P

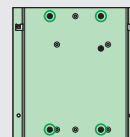

A'

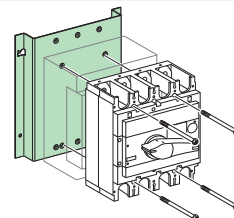

INS-INV 320/630
 PowerTag INS-INV 320/630

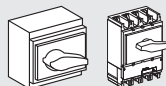

3P/4P

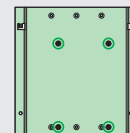

B

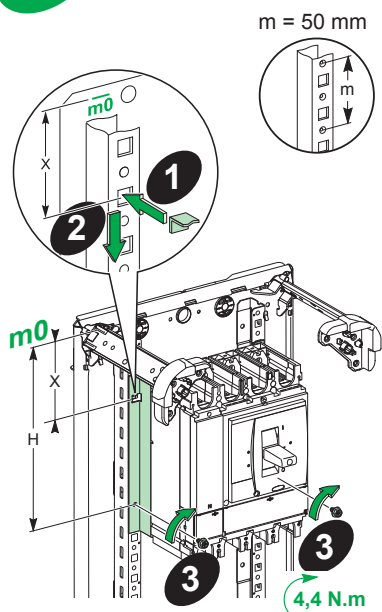

3P/4P

NSX 400/630
 NSX Vigi 400/630 (ELCB)
 CVS 400/630



X = 216

m = 12m

H = 600

Vigi NSX 400/630



X = 266

m = 14m

H = 700

Vigi CVS 400/630



X = 366

m = 13m

H = 650

INS-INV 320/400



X = 166

m = 10m

H = 500

INS-INV 500/630



X = 266

m = 12m

H = 600

PowerTag NSX 400/630
 PowerTag NSX Vigi 400/630 (ELCB)



X = 215

m = 14m

H = 700

PowerTag INS-INV 320/400



X = 166

m = 12m

H = 600

PowerTag INS-INV 500/630



X = 266

m = 14m

H = 700

i

NSX Vigi 400/630 (ELCB)

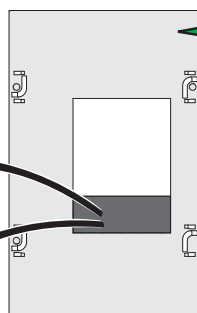

03298

180°

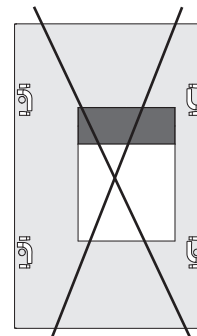

Schneider Electric Industries SAS

35, rue Joseph Monier
 92500 Rueil-Malmaison
 France

<http://www.schneider-electric.com>

04696030AG

En raison de l'évolution des normes et du matériel, les caractéristiques indiquées par le texte et les images de ce document ne nous engageant qu'après confirmation par nos services.

As standards, specifications and designs change from time to time, please ask for confirmation of the information given in this publication.

Publication : Schneider Electric
 Réalisation :
 Impression :
 format de pliage : 105 x 148.5



Ce document a été imprimé sur du papier écologique.

This document has been printed on ecological paper.

02/2018