

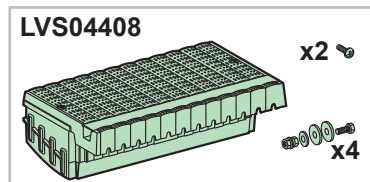

en fr es de it pt zh ru

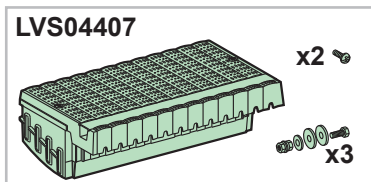

<p>PLEASE NOTE Electrical equipment should be installed, operated, serviced, and maintained only by qualified personnel. No responsibility is assumed by Schneider Electric for any consequences arising out of the use of this material.</p>	<p>REMARQUE IMPORTANTE L'installation, l'utilisation, la réparation et la maintenance des équipements électriques doivent être assurés uniquement par du personnel qualifié. Schneider Electric décline toute responsabilité quant aux conséquences de l'utilisation de ce matériel.</p>	<p>TENGA EN CUENTA La instalación, manejo, puesta en servicio y mantenimiento de equipos eléctricos deberán ser realizados sólo por personal cualificado. Schneider Electric no se hace responsable de ninguna de las consecuencias del uso de este material.</p>	<p>BITTE BEACHTEN Elektrische Geräte dürfen nur von Fachpersonal installiert, betrieben, bedient und gewartet werden. Schneider Electric haftet nicht für Schäden, die durch die Verwendung dieses Materials entstehen.</p>
<p>NOTA Manutenzione, riparazione, installazione e uso delle apparecchiature elettriche si devono affidare solo a personale qualificato. Schneider Electric non si assume alcuna responsabilità per qualsiasi conseguenza derivante dall'uso di questo materiale.</p>	<p>NOTA A instalação, utilização e manutenção do equipamento eléctrico devem ser efectuadas exclusivamente por pessoal qualificado. A Schneider Electric não assume qualquer responsabilidade pelas consequências resultantes da utilização deste material.</p>	<p>请注意 电气设备的安装、操作、维修和维护工作仅限于合格人员执行。Schneider Electric不承担由于使用本资料所引起的任何后果。</p>	<p>ОБРАТИТЕ ВНИМАНИЕ Установка, эксплуатация, ремонт и обслуживание электрического оборудования может выполняться только квалифицированными электриками. Компания Schneider Electric не несет никакой ответственности за любые возможные последствия использования данной документации.</p>

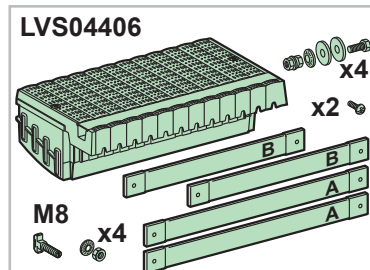
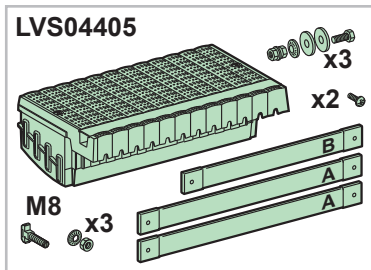
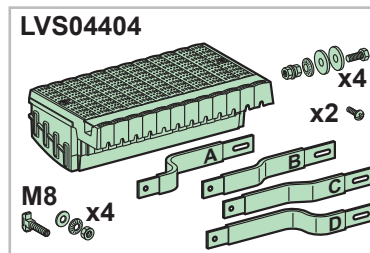
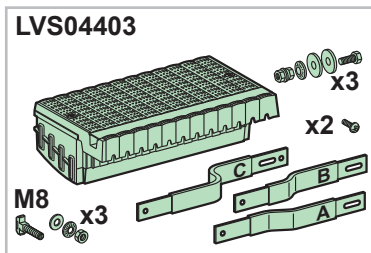
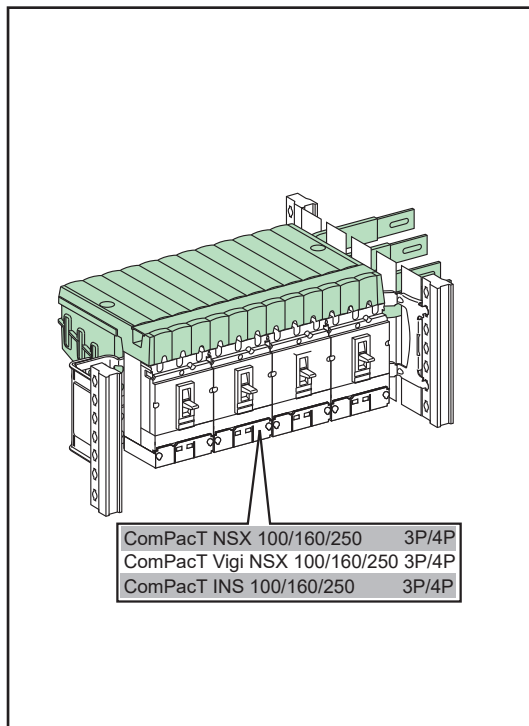

<p>PrismaSeT switchboards equipped with the Linery busbar connection system and Schneider Electric switchgear are subject to IEC 61439-1 & 2 certification. The instructions in this document describe how to fit Linery in a PrismaSeT switchboard. The installer is fully liable if it is fitted in any other switchboard.</p>	<p>Les tableaux PrismaSeT équipés du système de répartition, de connexion Linery et d'appareillages Schneider Electric font l'objet d'une certification IEC61439-1 & 2. Les instructions de ce document décrivent le montage de Linery dans un tableau PrismaSeT. Le montage dans tout autre tableau est de la responsabilité du metteur en œuvre.</p>	<p>Los paneles PrismaSeT equipados con el sistema de distribución y conexión Linery y con equipos Schneider Electric cuentan con la certificación IEC61439-1 & 2. Las instrucciones de este documento describen el montaje de Linery en el interior de un panel PrismaSeT. El montaje de dicho sistema en cualquier otro panel será responsabilidad del instalador.</p>	<p>Die PrismaSeT-Schaltanlage mit Verteilungssystem sowie Anschluss für Linery-Systeme und Geräte von Schneider Electric sind gemäß IEC61439-1 & 2 zertifiziert. Die Anweisungen in diesem Dokument beschreiben die Montage des Linery-Systems in einer PrismaSeT-Schaltanlage. Die Montage in einer anderen Schaltanlage obliegt dem Nutzer.</p>
<p>I quadri PrismaSeT dotati di sistema di ripartizione e connessione Linery e di apparecchiature Schneider Electric sono certificati secondo la norma IEC 61439-1 e 2. Le presenti istruzioni descrivono il montaggio di Linery in un quadro PrismaSeT. Il montaggio in qualsiasi altro quadro ricade sotto la responsabilità dell'installatore.</p>	<p>Os quadros PrismaSeT equipados com o sistema de repartição e ligação Linery e as aparelhagens Schneider Electric são objecto de uma certificação IEC61439-1 & 2. A instruções deste documento descrevem a montagem de Linery num quadro PrismaSeT. A montagem em qualquer outro quadro é da responsabilidade do instalador.</p>	<p>配有 Linery 母线连接系统和 Schneider Electric 开关设备的 PrismaSeT 配电盘通过 IEC 61439-1 & 2 认证。本文阐释如何在 PrismaSeT 配电盘中安装 Linery。如果安装在任何其它配电盘中，该安装程序也同样适用。</p>	<p>Распределительные щиты PrismaSeT, снабженные системой соединения сборной шины Linery и распределительного устройства Schneider Electric, подпадают под сертификацию IEC 61439-1 и 2. Инструкции в данном документе объясняют как установить Linery в распределительный щит PrismaSeT. Ответственность за установку в любой иной распределительный щит полностью лежит на монтажнике.</p>

A

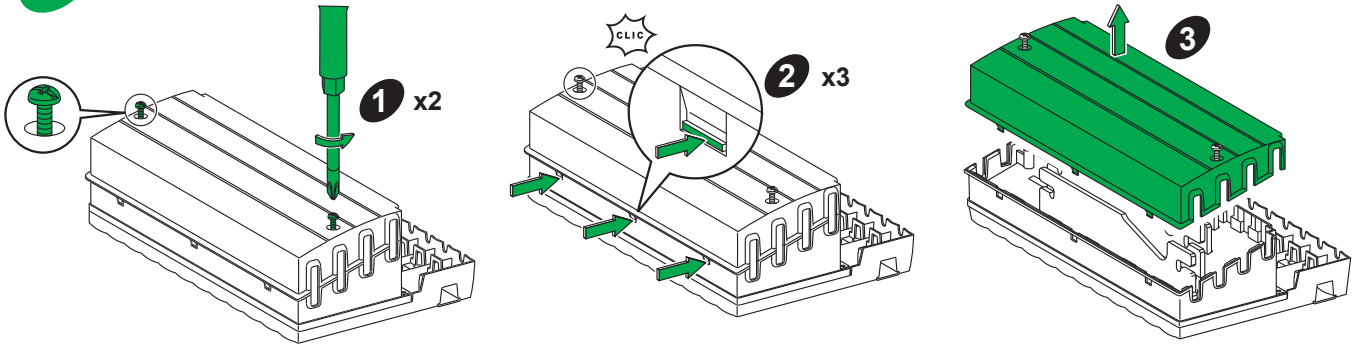

B

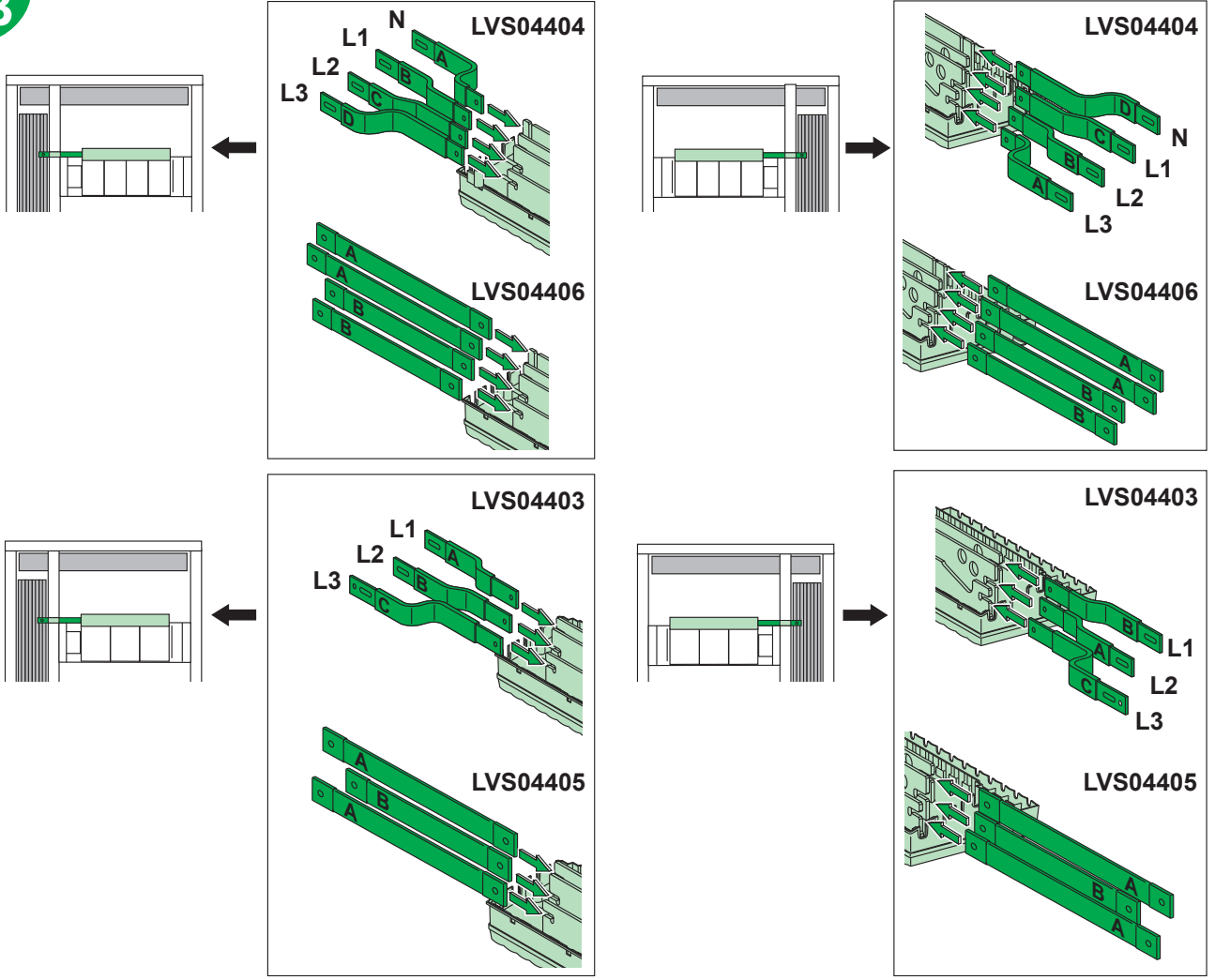

C

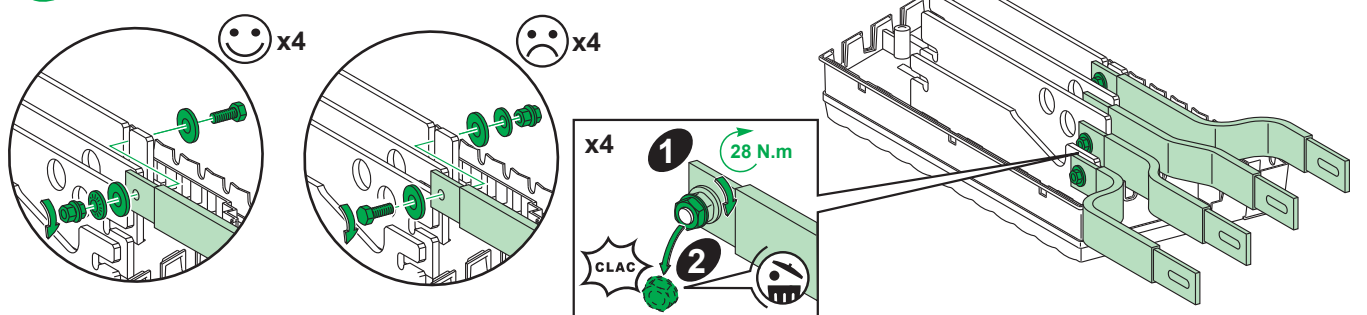

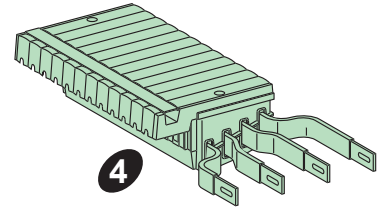
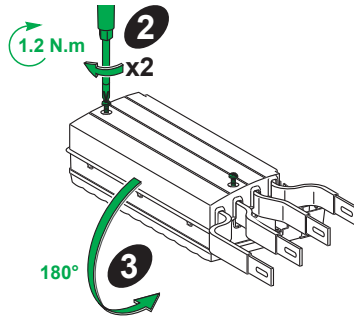
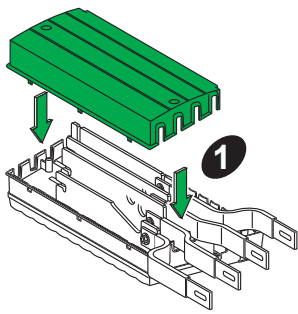
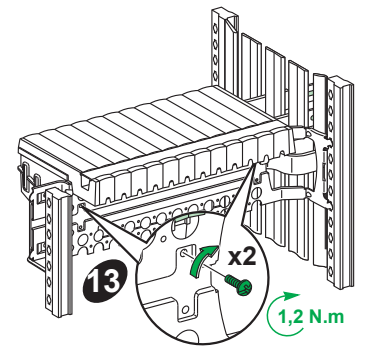
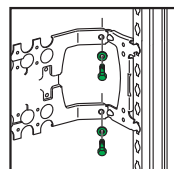
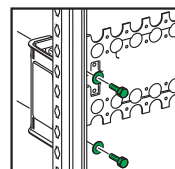
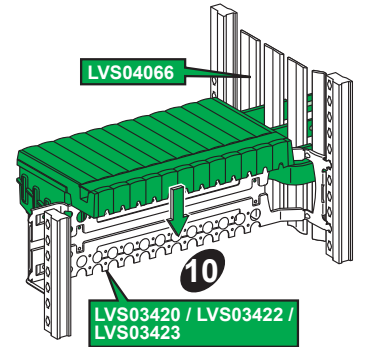
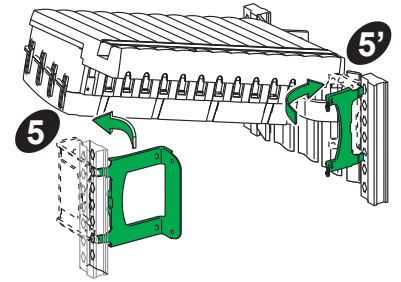
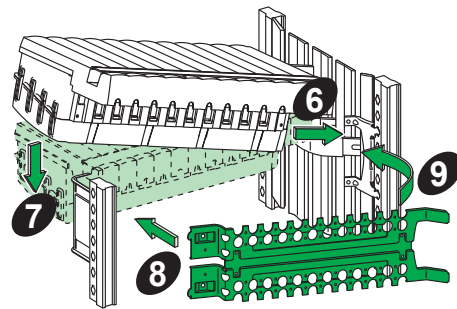
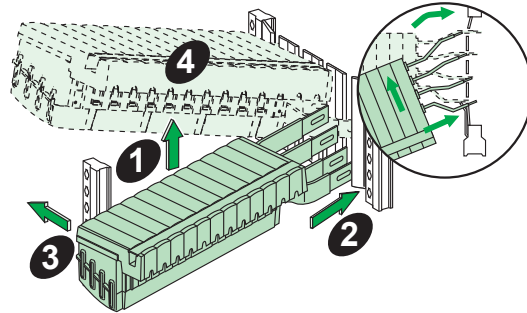
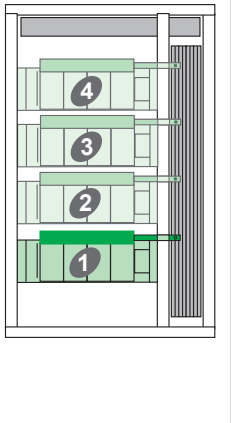
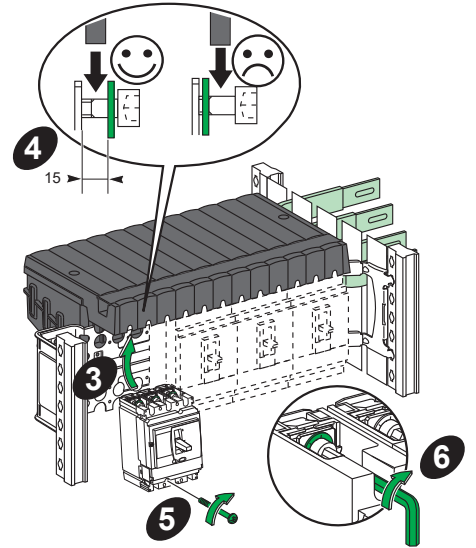
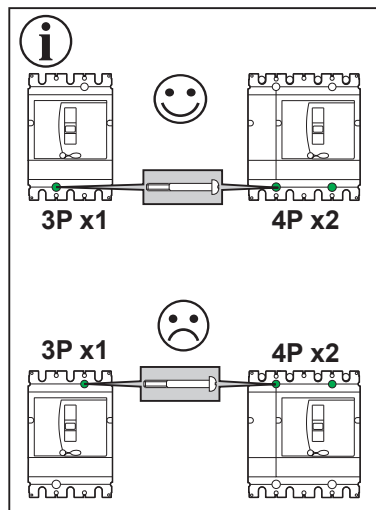
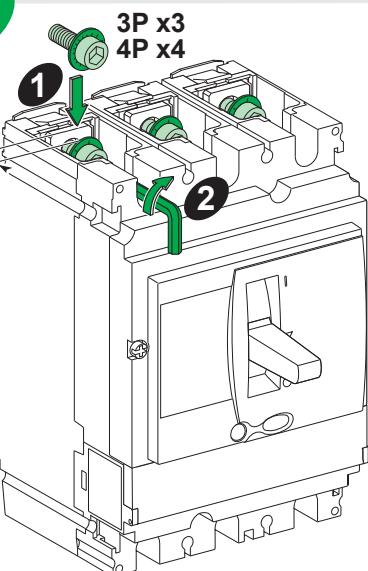
D**E****i****F****i**

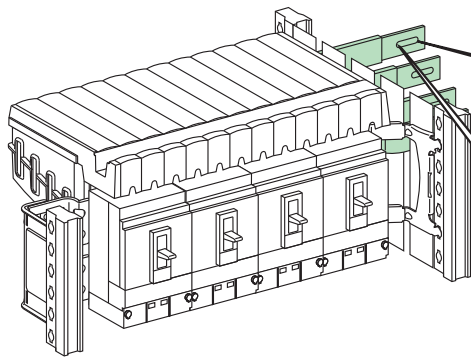
G

X3 LVS04403 / LVS04407

X4 LVS04404 / LVS04408

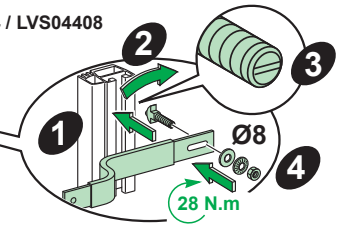
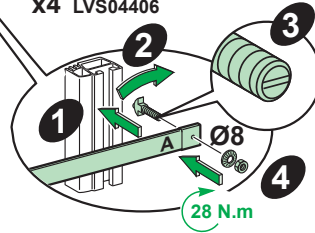
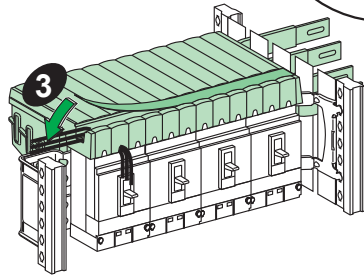
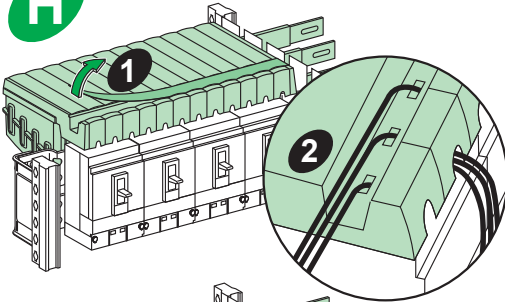
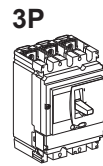
X3 LVS04405
X4 LVS04406**H****I**

3P

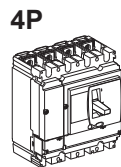
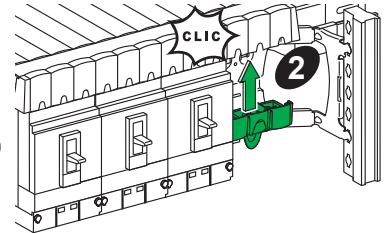
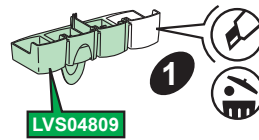

4P

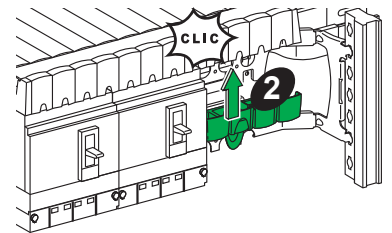
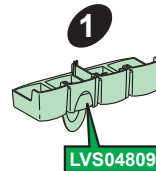

LVS04809

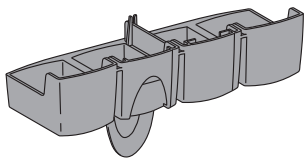

LVS03222 / LVS03249

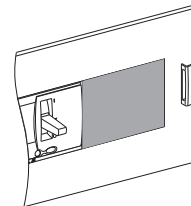

Ce produit doit être installé, raccordé et utilisé en respectant les normes et/ou les règlements d'installation en vigueur.

This product must be installed, connected and used in compliance with prevailing standards and/or installation regulations.

Schneider Electric Industries SAS

35, rue Joseph Monier
92500 Rueil-Malmaison
France

www.se.com

En raison de l'évolution des normes et du matériel, les caractéristiques indiquées par le texte et les images de ce document ne nous engageant qu'après confirmation par nos services.

As standards, specifications and designs change from time to time, please ask for confirmation of the information given in this publication.

Publication : Schneider Electric
Réalisation : Schneider Electric
Impression :
Format de pliage :



Ce document a été imprimé sur du papier écologique.

This document has been printed on ecological paper.

Schneider Electric Limited
Stafford Park 5
Telford, TF3 3BL
United Kingdom
www.se.com/uk

**UK
CA**