

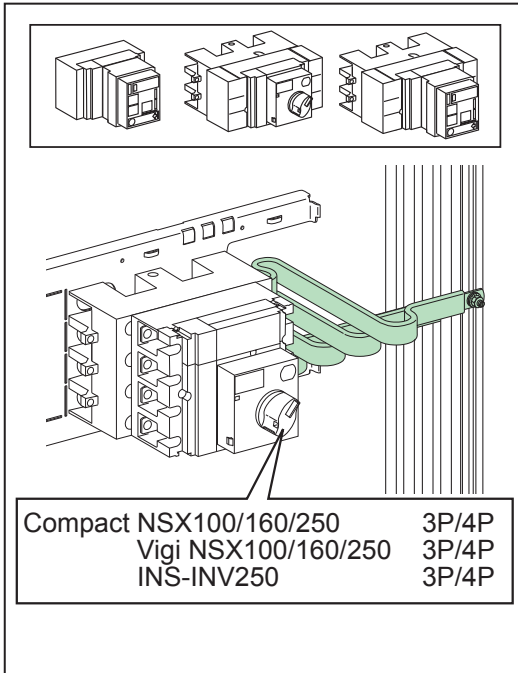

en fr es de it pt zh ru

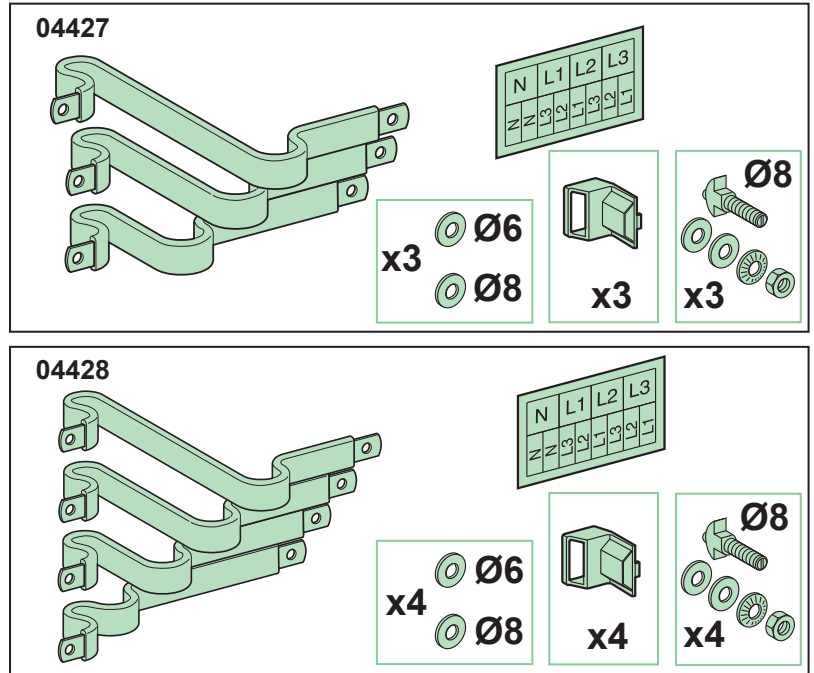

Compact NSX100/160/250 3P/4P
Vigi NSX100/160/250 3P/4P
INS-INV250 3P/4P



<p>PLEASE NOTE Electrical equipment should be installed, operated, serviced, and maintained only by qualified personnel. No responsibility is assumed by Schneider Electric for any consequences arising out of the use of this material.</p>	<p>REMARQUE IMPORTANTE L'installation, l'utilisation, la réparation et la maintenance des équipements électriques doivent être assurées uniquement par du personnel qualifié. Schneider Electric décline toute responsabilité quant aux conséquences de l'utilisation de ce matériel.</p>	<p>TENGA EN CUENTA La instalación, manejo, puesta en servicio y mantenimiento de equipos eléctricos deberán ser realizados sólo por personal cualificado. Schneider Electric no se hace responsable de ninguna dev las consecuencias del uso de este material.</p>	<p>BITTE BEACHTEN Elektrische Geräte dürfen nur von Fachpersonal installiert, betrieben, bedient und gewartet werden. Schneider Electric haftet nicht für Schäden, die durch die Verwendung dieses Materials entstehen.</p>
<p>NOTA Manutenzione, riparazione, installazione e uso delle apparecchiature elettriche si devono affidare solo a personale qualificato. Schneider Electric non si assume alcuna responsabilità per qualsiasi conseguenza derivante dall'uso di questo materiale.</p>	<p>NOTA A instalação, utilização e manutenção do equipamento eléctrico devem ser efectuadas exclusivamente por pessoal qualificado. A Schneider Electric não assume qualquer responsabilidade pelas consequências resultantes da utilização deste material.</p>	<p>请注意 电气设备的安装、操作、维修和维护工作仅限于合格人员执行。Schneider Electric 不承担由于使用本资料所引起的任何后果”。</p>	<p>ОБРАТИТЕ ВНИМАНИЕ Установка, эксплуатация, ремонт и обслуживание электрического оборудования может выполняться только квалифицированными электриками. Компания Schneider Electric не несет никакой ответственности за любые возможные последствия использования данной документации.</p>

⚠️ DANGER / DANGER / PELIGRO / GEFAHR / PERICOLO / PERIGO / 危险 / ОПАСНО

<p>HAZARD OF ELECTRIC SHOCK, EXPLOSION, OR ARC FLASH</p> <ul style="list-style-type: none"> ● Disconnect all power before servicing equipment. ● Always use a properly rated voltage sensing device to confirm that all power is off. <p>Failure to follow these instructions will result in death or serious injury.</p>	<p>RISQUE D'ÉLECTROCUTION, D'EXPLOSION OU D'ARC ÉLECTRIQUE</p> <ul style="list-style-type: none"> ● Coupez toutes les alimentations avant de travailler sur cet appareil. ● Vérifiez toujours que toutes les alimentations sont coupées à l'aide d'un dispositif de détection de tension approprié. <p>Le non-respect de ces instructions provoquera la mort ou des blessures graves.</p>	<p>PELIGRO DE DESCARGA ELÉCTRICA, EXPLOSIÓN O ARCO ELÉCTRICO</p> <ul style="list-style-type: none"> ● Desconecte todas las alimentaciones antes de manipular el producto. ● Per verificare che l'alimentazione sia isolata usare sempre un rilevatore di tensione correttamente tarato. <p>Si no se siguen estas instrucciones provocará lesiones graves o incluso la muerte.</p>	<p>GEFAHR VON ELEKTRISCHEM SCHLAG, EXPLOSION ODER LICHTBOGEN</p> <ul style="list-style-type: none"> ● Vor dem Arbeiten am Gerät alle Spannungsversorgungen abschalten. ● Verwenden Sie stets ein Spannungsprüfgerät mit der korrekten Bemessungsspannung, um festzustellen, ob die Spannungsversorgung wirklich abgeschaltet ist. <p>Die Nichtbeachtung dieser Anweisungen führt zu Tod oder schwerer Körperverletzung.</p>
<p>RISCHIO DI SCARICA ELETTRICA, ESPLOSIONE O ARCO ELETTRICO</p> <ul style="list-style-type: none"> ● Scollegare l'appare cchio da tutti i circuiti di alimentazione prima di qualsiasi intervento. ● Per verificare che l'alimentazione sia isolata usare sempre un rilevatore di tensione correttamente tarato. <p>Il mancato rispetto di queste istruzioni provocherà morte o gravi infortuni.</p>	<p>RISCO DE ELECTROCUSSÃO, DE EXPLOSAÇÃO, OU DE ARCO ELÉCTRICO</p> <ul style="list-style-type: none"> ● Desconecte todas as alimentações antes de manipular o produto. ● Utilize sempre um dispositivo de detecção da tensão nominal adequada para confirmar se a alimentação está desligada. <p>A não observância destas instruções resultará em morte, ou ferimentos graves.</p>	<p>可能有触电、爆炸或者电弧灼伤的危险</p> <ul style="list-style-type: none"> ● 在此电力设备上工作时请先切断所有电源。 ● 确保使用合适的额定电压传感器确认电源已关闭。 <p>若违背这些说明，则可能会导致严重的人身伤害甚至死亡</p>	<p>Опасность поражением электрическим током, опасность взрыва или вспышки дуги</p> <ul style="list-style-type: none"> ● Перед обслуживанием или ремонтом убедитесь, что питание отключено. ● Чтобы убедиться в отключении питания, обязательно используйте тестер надлежащего номинала. <p>Несоблюдение этих инструкций приведет к смерти или серьезной травме</p>

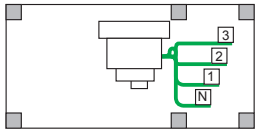
A

04427

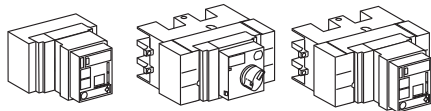

04428

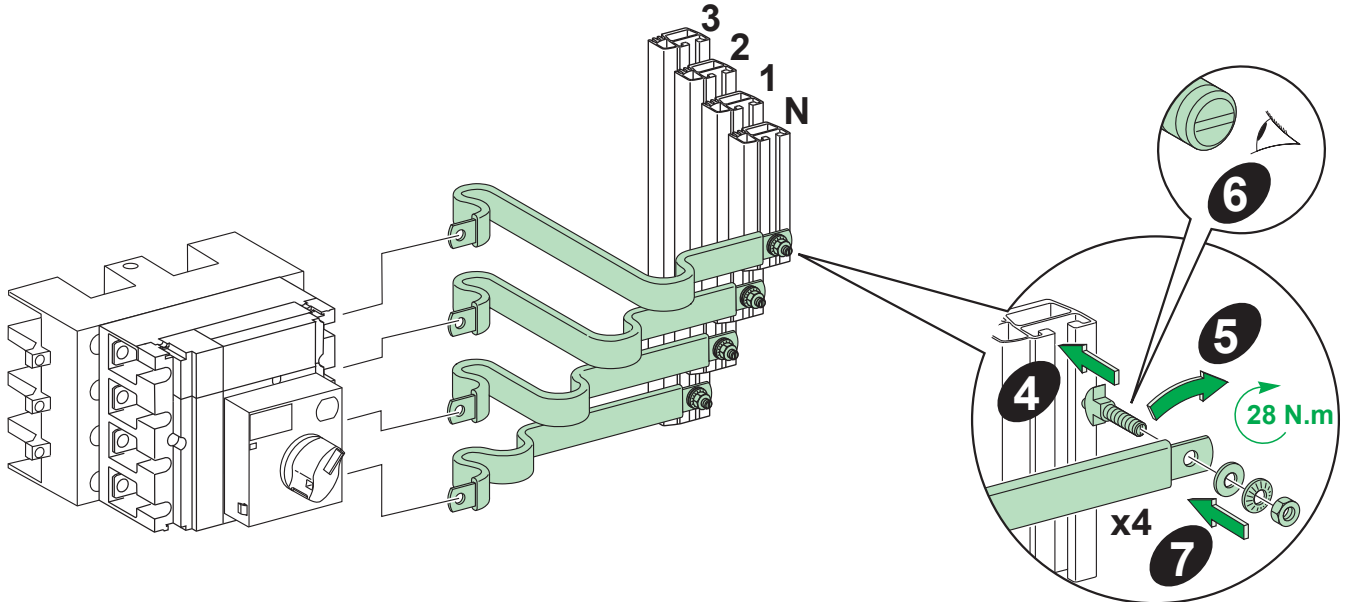
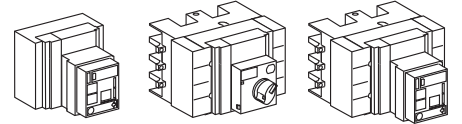
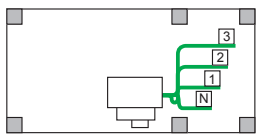
**A'**

04427



04428

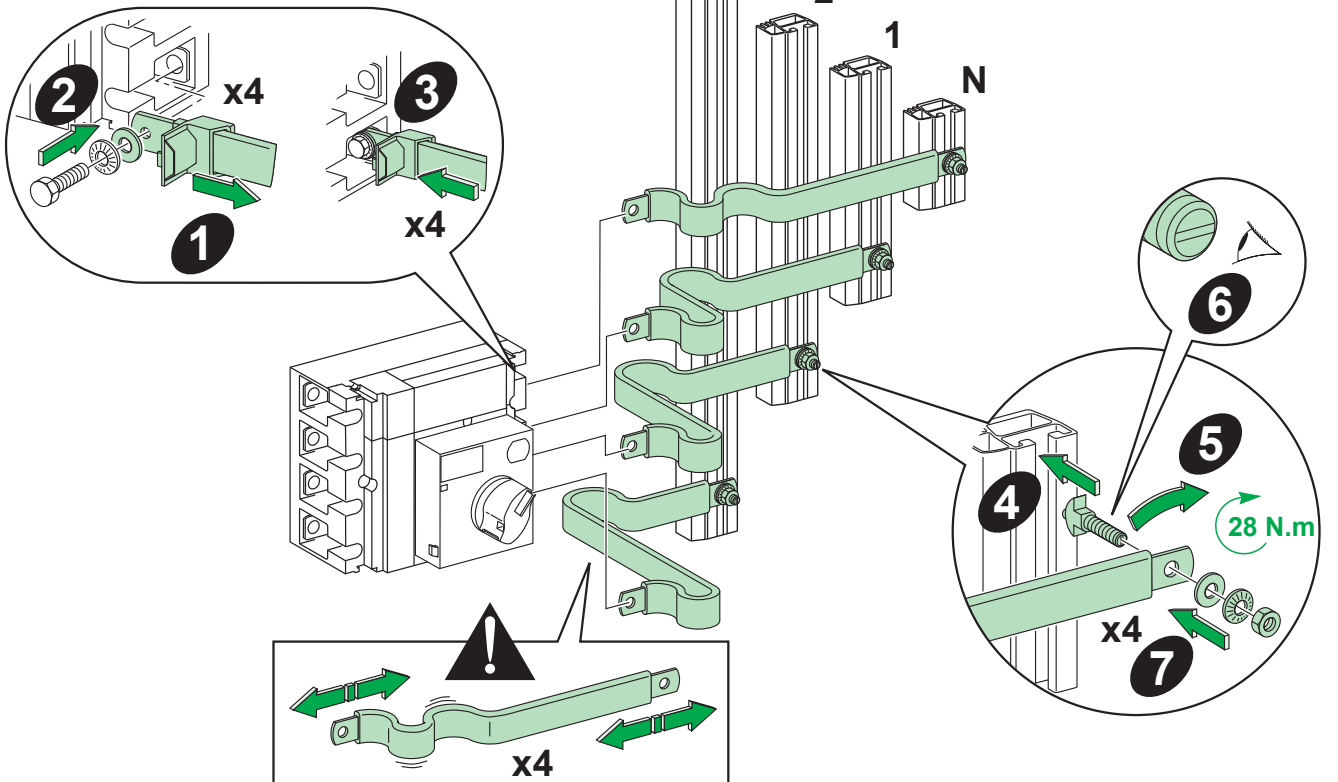
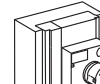

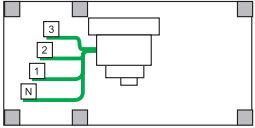
B

04427

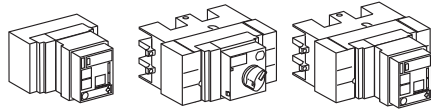

04428

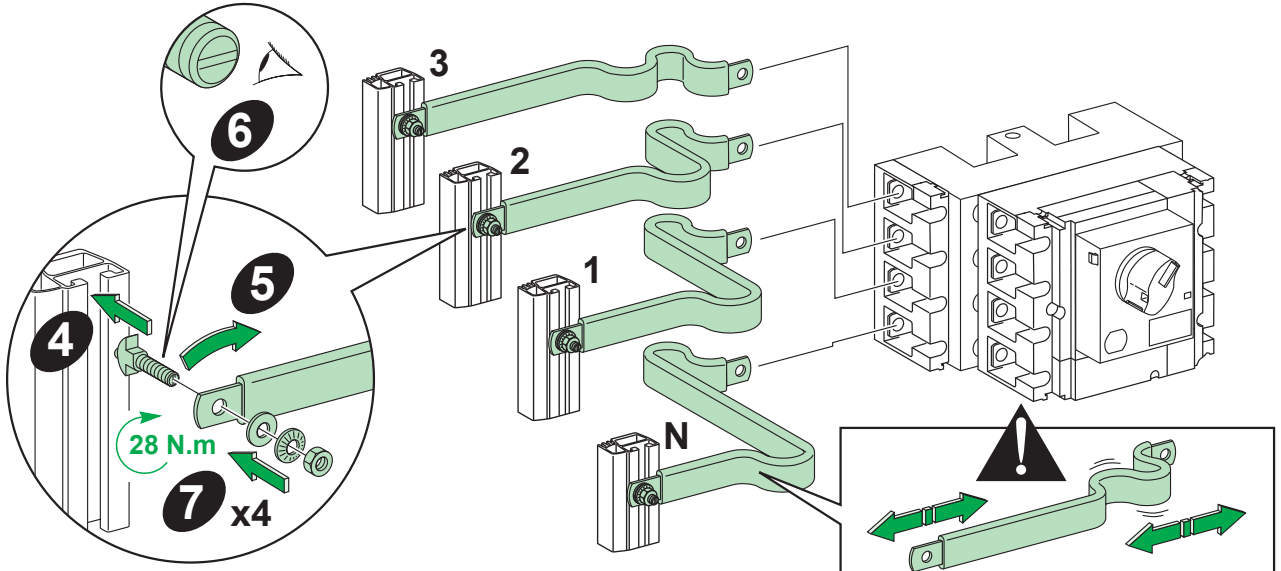
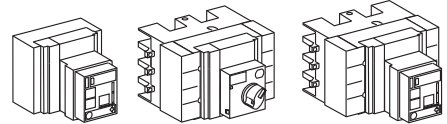
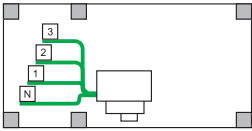
**B'**

04427

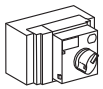

04428

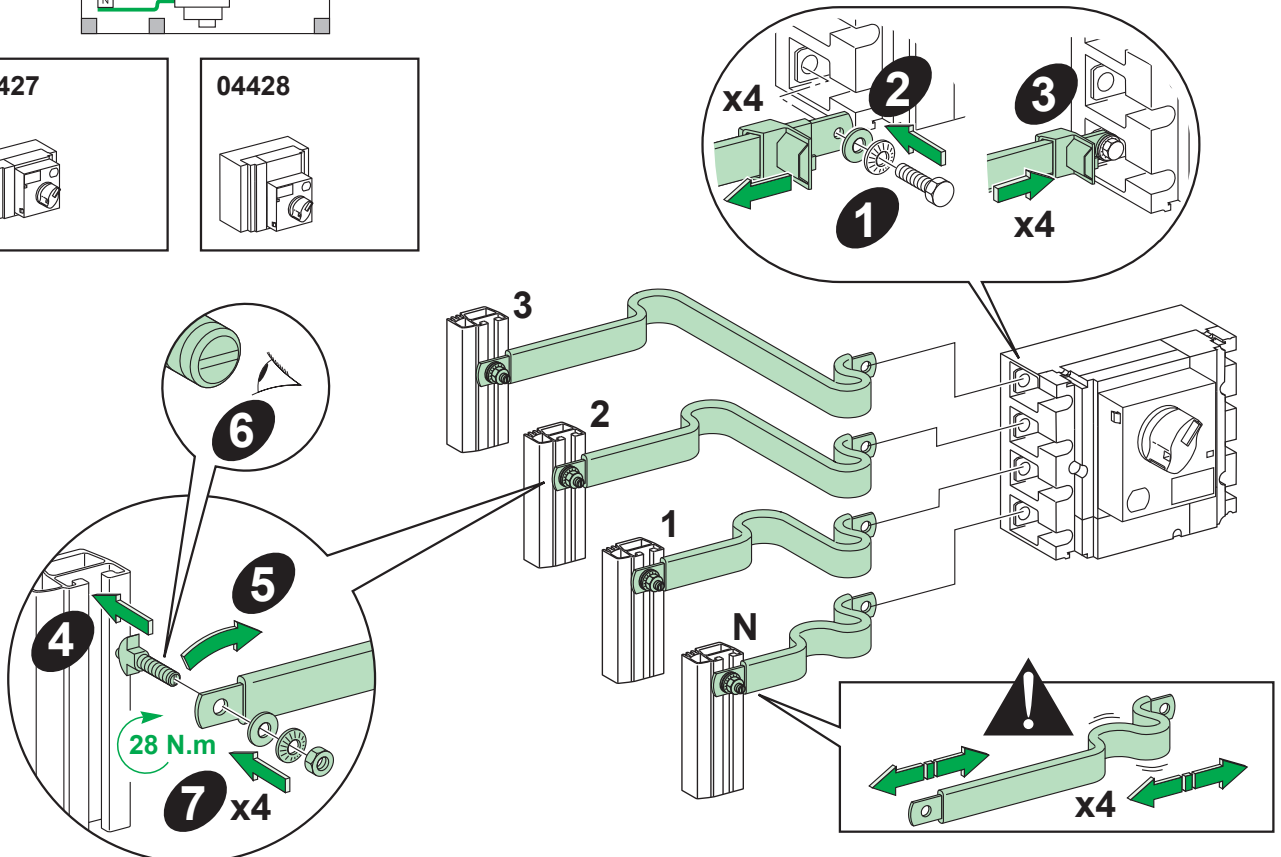
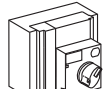



1

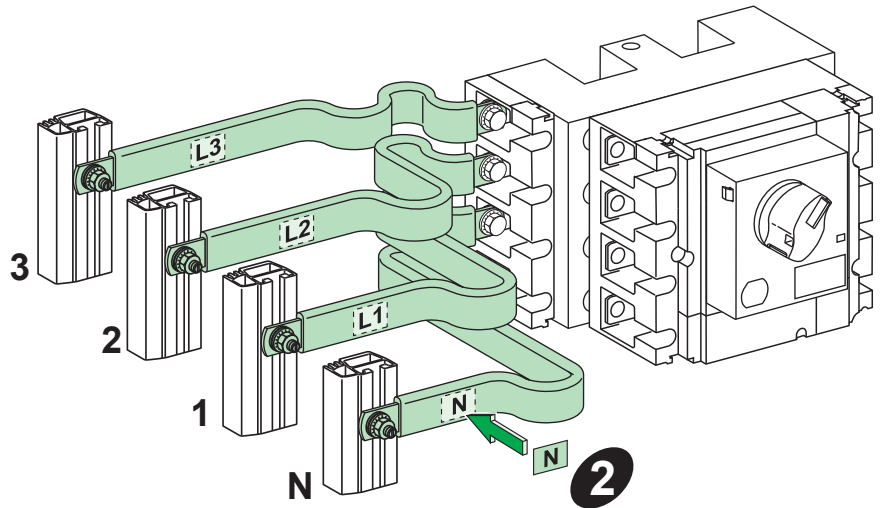
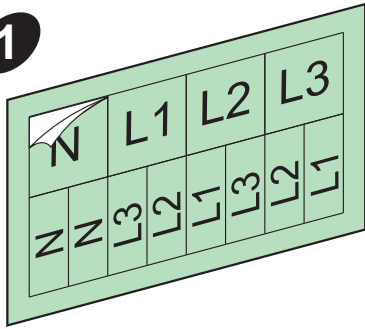

Prisma



04794

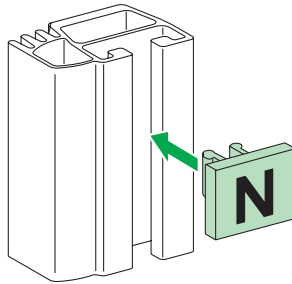

Prisma



04766

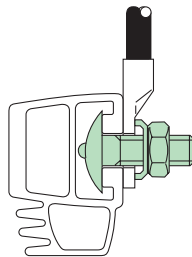

Schneider Electric Industries SAS
35, rue Joseph Monier
92506 Rueil Malmaison
France

<http://www.schneider-electric.com>

04696149AG - 00

En raison de l'évolution des normes et du matériel, les caractéristiques indiquées par le texte et les images de ce document ne nous engagent qu'après confirmation par nos services.

As standards, specifications and designs change from time to time, please ask for confirmation of the information given in this publication.

Publication : Schneider Electric
Réalisation : Schneider Electric
Impression :
Format de pliage : 210 x 297 mm

© 2014 Schneider Electric - All rights reserved.



Ce document a été imprimé sur du papier écologique.
This document has been printed on ecological paper.

01/2014