

# Easy UPS 3M Advanced

## 100-250 kW UPS

### Technical Specifications

Latest updates are available on the Schneider Electric website  
08/2023

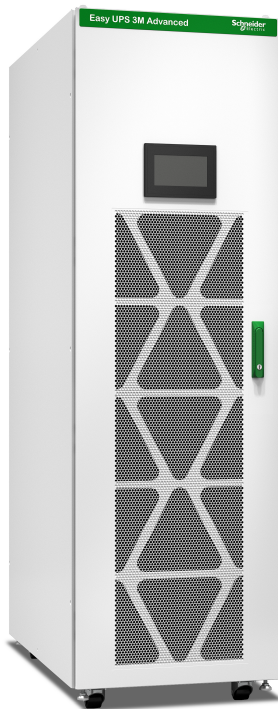

# Legal Information

The Schneider Electric brand and any trademarks of Schneider Electric SE and its subsidiaries referred to in this guide are the property of Schneider Electric SE or its subsidiaries. All other brands may be trademarks of their respective owners.

This guide and its content are protected under applicable copyright laws and furnished for informational use only. No part of this guide may be reproduced or transmitted in any form or by any means (electronic, mechanical, photocopying, recording, or otherwise), for any purpose, without the prior written permission of Schneider Electric.

Schneider Electric does not grant any right or license for commercial use of the guide or its content, except for a non-exclusive and personal license to consult it on an "as is" basis. Schneider Electric products and equipment should be installed, operated, serviced, and maintained only by qualified personnel.

As standards, specifications, and designs change from time to time, information contained in this guide may be subject to change without notice.

To the extent permitted by applicable law, no responsibility or liability is assumed by Schneider Electric and its subsidiaries for any errors or omissions in the informational content of this material or consequences arising out of or resulting from the use of the information contained herein.

# Table of Contents

Important Safety Instructions — SAVE THESE INSTRUCTIONS .....	5
Electromagnetic Compatibility .....	6
Safety Precautions .....	6
Additional Safety Precautions After Installation.....	8
Electrical Safety .....	9
Battery Safety .....	10
Symbols Used in the Product.....	12
Model List.....	13
Overview .....	14
Single System Overview .....	14
Input Voltage Window .....	16
Inverter Short Circuit Capabilities (Bypass not Available) .....	17
Efficiency.....	18
Derating Due to Load Power Factor.....	19
Batteries .....	20
End of Discharge Voltage .....	20
Standard VRLA Voltage Levels .....	20
Compliance.....	21
Communication and Management .....	22
EPO .....	23
Configurable Input Contacts and Output Relays .....	24
Requirements for a Third Party Battery Solution.....	25
Third Party Battery Breaker Requirements.....	25
Guidance for Organizing Battery Cables.....	26
Specifications .....	27
Specifications for 100 kW UPS .....	27
Specifications for 150 kW UPS .....	29
Specifications for 200 kW UPS .....	31
Specifications for 250 kW UPS .....	33
Required Upstream Protection.....	35
Recommended Cables Sizes .....	36
Recommended Bolt and Lug Sizes .....	37
Torque Specifications.....	37
Physical .....	38
UPS Shipping Weights and Dimensions .....	38
UPS Weights and Dimensions .....	38
Clearance .....	39
Environment.....	40
Heat Dissipation in BTU/hr .....	41
Drawings .....	42
Easy UPS 3M Advanced 100-250 kW 400 V UPS .....	42
Options .....	43
Configuration Options .....	43
Hardware Options.....	44

Limited Factory Warranty.....45

# Important Safety Instructions — SAVE THESE INSTRUCTIONS

Read these instructions carefully and look at the equipment to become familiar with it before trying to install, operate, service or maintain it. The following safety messages may appear throughout this manual or on the equipment to warn of potential hazards or to call attention to information that clarifies or simplifies a procedure.



The addition of this symbol to a “Danger” or “Warning” safety message indicates that an electrical hazard exists which will result in personal injury if the instructions are not followed.



This is the safety alert symbol. It is used to alert you to potential personal injury hazards. Obey all safety messages with this symbol to avoid possible injury or death.

## **DANGER**

**DANGER** indicates a hazardous situation which, if not avoided, **will result in death or serious injury.**

**Failure to follow these instructions will result in death or serious injury.**

## **WARNING**

**WARNING** indicates a hazardous situation which, if not avoided, **could result in death or serious injury.**

**Failure to follow these instructions can result in death, serious injury, or equipment damage.**

## **CAUTION**

**CAUTION** indicates a hazardous situation which, if not avoided, **could result in minor or moderate injury.**

**Failure to follow these instructions can result in injury or equipment damage.**

## **NOTICE**

**NOTICE** is used to address practices not related to physical injury. The safety alert symbol shall not be used with this type of safety message.

**Failure to follow these instructions can result in equipment damage.**

## Please Note

Electrical equipment should only be installed, operated, serviced, and maintained by qualified personnel. No responsibility is assumed by Schneider Electric for any consequences arising out of the use of this material.

A qualified person is one who has skills and knowledge related to the construction, installation, and operation of electrical equipment and has received safety training to recognize and avoid the hazards involved.

Per IEC 62040-1: "Uninterruptible power systems (UPS) -- Part 1: Safety Requirements," this equipment, including battery access, must be inspected, installed and maintained by a skilled person.

The skilled person is a person with relevant education and experience to enable him or her to perceive risks and to avoid hazards which the equipment can create (reference IEC 62040, section 3.102).

## Electromagnetic Compatibility

### **NOTICE**

#### **RISK OF ELECTROMAGNETIC DISTURBANCE**

This is a product category C3 UPS product. In a residential environment, this product may cause radio interference, in which case the user may be required to take additional measures.

**Failure to follow these instructions can result in equipment damage.**

## Safety Precautions

### **⚠ DANGER**

#### **HAZARD OF ELECTRIC SHOCK, EXPLOSION, OR ARC FLASH**

All safety instructions in this document must be read, understood and followed.

**Failure to follow these instructions will result in death or serious injury.**

### **⚠ DANGER**

#### **HAZARD OF ELECTRIC SHOCK, EXPLOSION, OR ARC FLASH**

Read all instructions in the Installation Manual before installing or working on this UPS system.

**Failure to follow these instructions will result in death or serious injury.**

### **⚠ DANGER**

#### **HAZARD OF ELECTRIC SHOCK, EXPLOSION, OR ARC FLASH**

Do not install the UPS system until all construction work has been completed and the installation room has been cleaned.

**Failure to follow these instructions will result in death or serious injury.**

### **⚠ DANGER**

#### **HAZARD OF ELECTRIC SHOCK, EXPLOSION, OR ARC FLASH**

- The product must be installed according to the specifications and requirements as defined by Schneider Electric. It concerns in particular the external and internal protections (upstream breakers, battery breakers, cabling, etc.) and environmental requirements. No responsibility is assumed by Schneider Electric if these requirements are not respected.
- After the UPS system has been electrically wired, do not start up the system. Start-up must only be performed by Schneider Electric.

**Failure to follow these instructions will result in death or serious injury.**

**⚠ DANGER**

**HAZARD OF ELECTRIC SHOCK, EXPLOSION, OR ARC FLASH**

The UPS system must be installed according to local and national regulations. Install the UPS according to:

- IEC 60364 (including 60364-4-41 - protection against electric shock, 60364-4-42 - protection against thermal effect, and 60364-4-43 - protection against overcurrent), or
- NEC NFPA 70, or
- Canadian Electrical Code (C22.1, Part 1)

depending on which one of the standards apply in your local area.

**Failure to follow these instructions will result in death or serious injury.**

**⚠ DANGER**

**HAZARD OF ELECTRIC SHOCK, EXPLOSION, OR ARC FLASH**

- Install the UPS system in a temperature controlled indoor environment free of conductive contaminants and humidity.
- Install the UPS system on a non-flammable, level and solid surface (e.g. concrete) that can support the weight of the system.

**Failure to follow these instructions will result in death or serious injury.**

**⚠ DANGER**

**HAZARD OF ELECTRIC SHOCK, EXPLOSION, OR ARC FLASH**

The UPS is not designed for and must therefore not be installed in the following unusual operating environments:

- Damaging fumes
- Explosive mixtures of dust or gases, corrosive gases, or conductive or radiant heat from other sources
- Moisture, abrasive dust, steam or in an excessively damp environment
- Fungus, insects, vermin
- Salt-laden air or contaminated cooling refrigerant
- Pollution degree higher than 2 according to IEC 60664-1
- Exposure to abnormal vibrations, shocks, and tilting
- Exposure to direct sunlight, heat sources, or strong electromagnetic fields

**Failure to follow these instructions will result in death or serious injury.**

**⚠ DANGER**

**HAZARD OF ELECTRIC SHOCK, EXPLOSION, OR ARC FLASH**

Do not drill or cut holes for cables or conduits with the gland plates installed and do not drill or cut holes in close proximity to the UPS.

**Failure to follow these instructions will result in death or serious injury.**

**⚠ WARNING**

**HAZARD OF ARC FLASH**

Do not make mechanical changes to the product (including removal of cabinet parts or drilling/cutting of holes) that are not described in the Installation Manual.

**Failure to follow these instructions can result in death, serious injury, or equipment damage.**

**NOTICE****RISK OF OVERHEATING**

Respect the space requirements around the UPS system and do not cover the product's ventilation openings when the UPS system is in operation.

**Failure to follow these instructions can result in equipment damage.**

**NOTICE****RISK OF EQUIPMENT DAMAGE**

Do not connect the UPS output to regenerative load systems including photovoltaic systems and speed drives.

**Failure to follow these instructions can result in equipment damage.**

## Additional Safety Precautions After Installation

** DANGER****HAZARD OF ELECTRIC SHOCK, EXPLOSION, OR ARC FLASH**

Do not install the UPS system until all construction work has been completed and the installation room has been cleaned. If additional construction work is needed in the installation room after this product has been installed, turn off the product and cover the product with the protective packaging bag the product was delivered in.

**Failure to follow these instructions will result in death or serious injury.**



## Electrical Safety

### **⚠ DANGER**

#### **HAZARD OF ELECTRIC SHOCK, EXPLOSION, OR ARC FLASH**

- Electrical equipment must be installed, operated, serviced, and maintained only by qualified personnel.
- Apply appropriate personal protective equipment (PPE) and follow safe electrical work practices.
- Turn off all power supplying the UPS system before working on or inside the equipment.
- Before working on the UPS system, check for hazardous voltage between all terminals including the protective earth.
- The UPS contains an internal energy source. Hazardous voltage can be present even when disconnected from the mains supply. Before installing or servicing the UPS system, ensure that the units are OFF and that mains and batteries are disconnected. Wait five minutes before opening the UPS to allow the capacitors to discharge.
- A disconnection device (e.g. disconnection circuit breaker or switch) must be installed to enable isolation of the system from upstream power sources in accordance with local regulations. The disconnection device must be easily accessible and visible.
- The UPS must be properly earthed/grounded and due to a high leakage current, the earthing/grounding conductor must be connected first.

**Failure to follow these instructions will result in death or serious injury.**

### **⚠ DANGER**

#### **HAZARD OF ELECTRIC SHOCK, EXPLOSION, OR ARC FLASH**

In systems where backfeed protection is not part of the standard design, an automatic isolation device (backfeed protection option or other device meeting the requirements of IEC/EN 62040-1 or UL1778 5th Edition – depending on which of the two standards apply to your local area) must be installed to prevent hazardous voltage or energy at the input terminals of the isolation device. The device must open within 15 seconds after the upstream power supply fails and must be rated according to the specifications.

**Failure to follow these instructions will result in death or serious injury.**

When the UPS input is connected through external isolators that, when opened, isolate the neutral or when the automatic backfeed isolation is provided external to the equipment or is connected to an IT power distribution system, a label must be fitted at the UPS input terminals, and on all primary power isolators installed remote from the UPS area and on external access points between such isolators and the UPS, by the user, displaying the following text (or equivalent in a language which is acceptable in the country in which the UPS system is installed):

### **⚠ DANGER**

#### **HAZARD OF ELECTRIC SHOCK, EXPLOSION, OR ARC FLASH**

Risk of Voltage Backfeed. Before working on this circuit: Isolate the UPS and check for hazardous voltage between all terminals including the protective earth.

**Failure to follow these instructions will result in death or serious injury.**

**⚠ CAUTION****RISK OF ELECTRICAL DISTURBANCE**

This product can cause a DC current in the PE conductor. Where a residual current-operated protective device (RCD) is used for protection against electrical shock, only an RCD of Type B is allowed on the supply side of this product.

**Failure to follow these instructions can result in injury or equipment damage.**

## Battery Safety

**⚡⚠ DANGER****HAZARD OF ELECTRIC SHOCK, EXPLOSION, OR ARC FLASH**

- Battery circuit breakers must be installed according to the specifications and requirements as defined by Schneider Electric.
- Servicing of batteries must only be performed or supervised by qualified personnel knowledgeable of batteries and the required precautions. Keep unqualified personnel away from batteries.
- Disconnect charging source prior to connecting or disconnecting battery terminals.
- Do not dispose of batteries in a fire as they can explode.
- Do not open, alter, or mutilate batteries. Released electrolyte is harmful to the skin and eyes. It may be toxic.

**Failure to follow these instructions will result in death or serious injury.**

**⚡⚠ DANGER****HAZARD OF ELECTRIC SHOCK, EXPLOSION, OR ARC FLASH**

Batteries can present a risk of electric shock and high short-circuit current. The following precautions must be observed when working on batteries

- Remove watches, rings, or other metal objects.
- Use tools with insulated handles.
- Wear protective glasses, gloves and boots.
- Do not lay tools or metal parts on top of batteries.
- Disconnect the charging source prior to connecting or disconnecting battery terminals.
- Determine if the battery is inadvertently grounded. If inadvertently grounded, remove source from ground. Contact with any part of a grounded battery can result in electric shock. The likelihood of such shock can be reduced if such grounds are removed during installation and maintenance (applicable to equipment and remote battery supplies not having a grounded supply circuit).

**Failure to follow these instructions will result in death or serious injury.**

**⚡⚠ DANGER****HAZARD OF ELECTRIC SHOCK, EXPLOSION, OR ARC FLASH**

When replacing batteries, always replace with the same type and number of batteries or battery packs.

**Failure to follow these instructions will result in death or serious injury.**

## **▲ CAUTION**















### **RISK OF EQUIPMENT DAMAGE**

- Mount the batteries in the UPS system, but do not connect the batteries until the UPS system is ready to be powered up. The time duration from battery connection until the UPS system is powered up must not exceed 72 hours or 3 days.
- Batteries must not be stored more than six months due to the requirement of recharging. If the UPS system remains de-energized for a long period, we recommend that you energize the UPS system for a period of 24 hours at least once every month. This charges the batteries, thus avoiding irreversible damage.

**Failure to follow these instructions can result in injury or equipment damage.**

**NOTE:** Always follow the battery manufacturer's installation manual for battery installation and maintenance instructions.

## Symbols Used in the Product

	This is the earthing/ground symbol.
	This is the protective earth/equipment grounding conductor symbol.
	This is the direct current symbol. It is also referred to as DC.
	This is the alternating current symbol. It is also referred to as AC.
	This is the positive polarity symbol. It is used to identify the positive terminal(s) of equipment which is used with, or generates direct current.
	This is the negative polarity symbol. It is used to identify the negative terminal(s) of equipment which is used with, or generates direct current.
	This is the battery symbol.
	This is the static switch symbol. It is used to indicate switches that are designed to connect or disconnect the load to or from the supply respectively without the existence of moving parts.
	This is the AC/DC converter (rectifier) symbol. It is used to identify an AC/DC converter (rectifier) and, in case of plug-in devices, to identify the relevant receptacles.
	This is the DC/AC converter (inverter) symbol. It is used to identify an DC/AC converter (inverter) and, in case of plug-in devices, to identify the relevant receptacles.
	This is the input symbol. It is used to identify an input terminal when it is necessary to distinguish between inputs and outputs.
	This is the output symbol. It is used to identify an output terminal when it is necessary to distinguish between inputs and outputs.
	This is the switch disconnecter symbol. It is used to identify the disconnecting device in the form of switch.
	This is the circuit breaker symbol. It is used to identify the disconnecting device in the form of circuit breaker that protects the equipment from short circuit or heavy load current. It opens the circuits once the current flow crosses its maximum limit.

## Model List

- Easy UPS 3M Advanced 100 kVA scalable to 150 kVA 400 V India for external batteries (E3MUPS100K150HIN)
- Easy UPS 3M Advanced 100 kVA scalable to 250 kVA 400 V India for external batteries (E3MUPS100K250HIN)

**NOTE:** 50 kW power modules (EMPM50KH) are bought separately for ratings over 100 kW.

# Overview

## Single System Overview

UIB	Unit input breaker
SSIB	Static switch input breaker
UOB	Unit output breaker
IMB	Internal maintenance breaker
BB	Battery breaker

### Single System – Single Mains

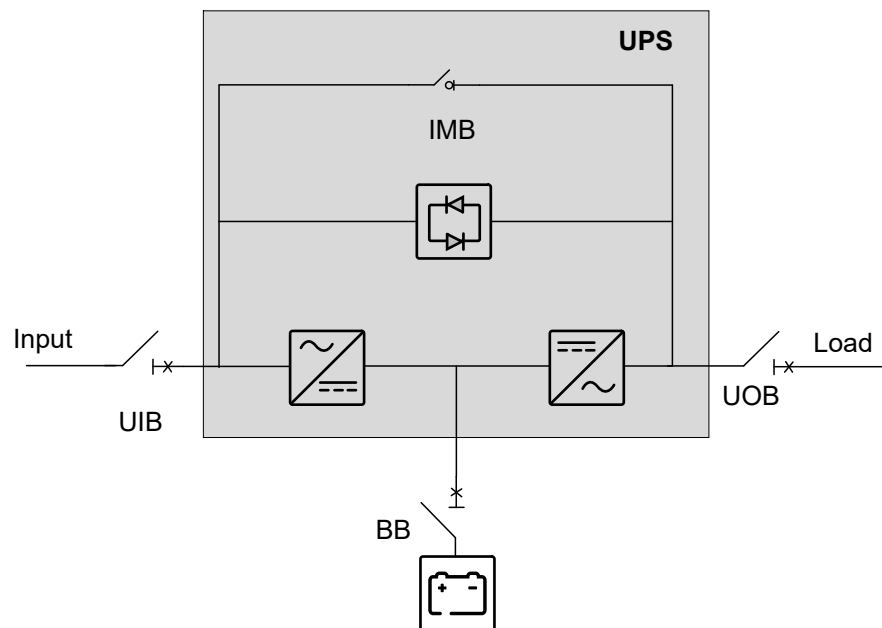

### Single System – Dual Mains

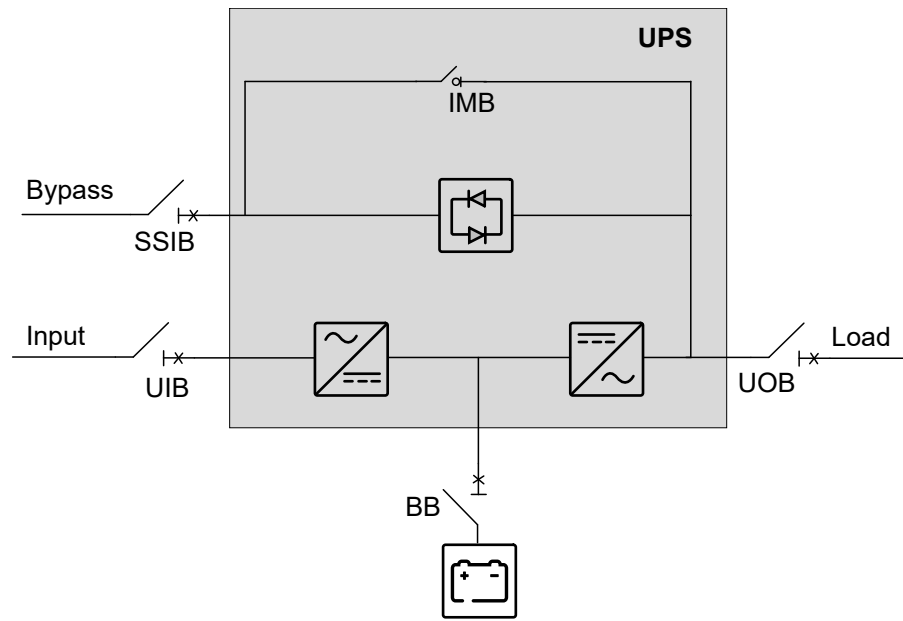

# Input Voltage Window

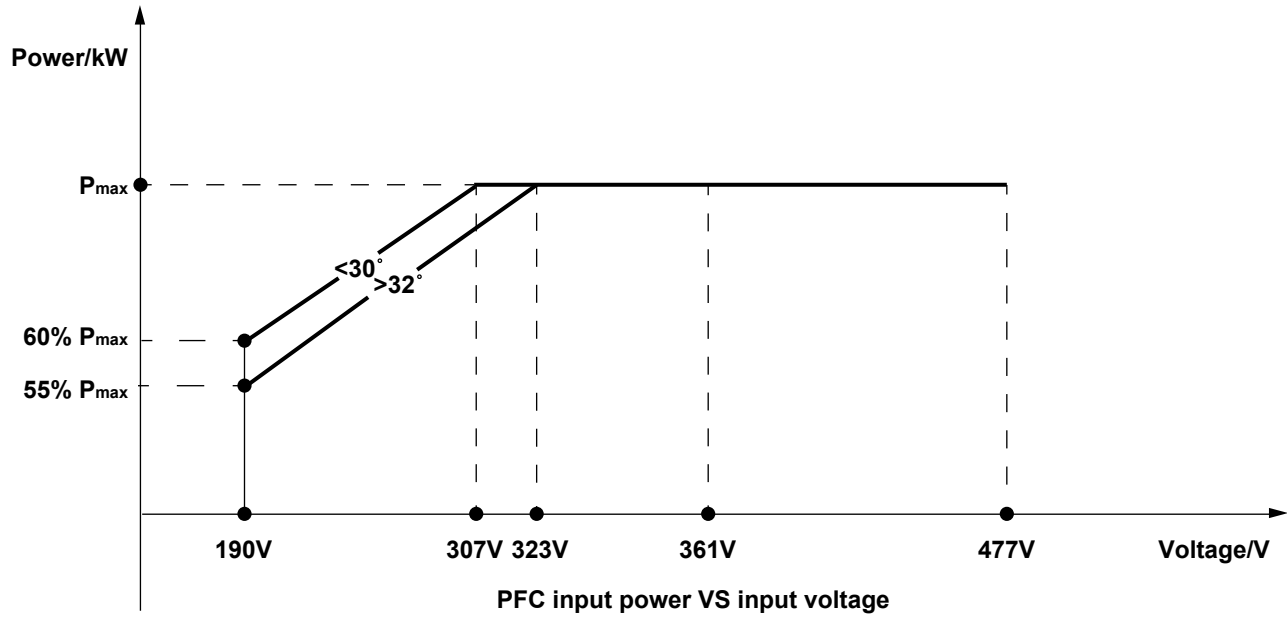



# Inverter Short Circuit Capabilities (Bypass not Available)

IK1	Short circuit between a phase and neutral
IK2	Short circuit between two phases
IK3	Short circuit between three phases

S [kW]	IK1	IK2	IK3
100	364 A/220 ms	344 A/220 ms	322 A/220 ms
150	546 A/220 ms	516 A/220 ms	483 A/220 ms
200	728 A/220 ms	688 A/220 ms	644 A/220 ms
250	904 A/220 ms	862 A/220 ms	807 A/220 ms

# Efficiency

100 kW	Normal operation			Battery operation			ECO mode		
	Voltage (V)	380	400	415	380	400	415	380	400
25% load	95.9%	95.9%	95.9%	96.8%	96.7%	96.6%	98.8%	99.0%	99.0%
50% load	96.0%	96.1%	96.1%	96.8%	96.9%	96.8%	99.1%	99.2%	99.3%
75% load	95.7%	95.8%	95.9%	96.4%	96.6%	96.5%	99.2%	99.3%	99.3%
100% load	95.2%	95.4%	95.3%	95.9%	96.2%	96.0%	99.2%	99.4%	99.4%

150 kW	Normal operation			Battery operation			ECO mode		
	Voltage (V)	380	400	415	380	400	415	380	400
25% load	95.9%	96.0%	95.9%	96.8%	96.7%	96.6%	99.0%	99.0%	99.0%
50% load	96.1%	96.2%	96.1%	96.8%	96.8%	96.8%	99.3%	99.2%	99.3%
75% load	95.7%	95.9%	95.8%	96.4%	96.5%	96.5%	99.3%	99.3%	99.3%
100% load	95.1%	95.4%	95.4%	95.9%	96.1%	96.0%	99.2%	99.3%	99.3%

200 kW	Normal operation			Battery operation			ECO mode		
	Voltage (V)	380	400	415	380	400	415	380	400
25% load	96.0%	96.0%	95.9%	96.8%	96.8%	96.7%	99.0%	99.0%	99.0%
50% load	96.1%	96.2%	96.1%	96.8%	96.9%	96.8%	99.2%	99.3%	99.2%
75% load	95.7%	95.9%	95.8%	96.5%	96.6%	96.5%	99.3%	99.3%	99.3%
100% load	95.1%	95.3%	95.4%	95.9%	96.1%	96.0%	99.2%	99.3%	99.3%

250 kW	Normal operation			Battery operation			ECO mode		
	Voltage (V)	380	400	415	380	400	415	380	400
25% load	96.0%	96.1%	96.0%	96.9%	96.9%	96.8%	99.0%	99.1%	99.0%
50% load	96.1%	96.2%	96.1%	97.0%	96.9%	97.0%	99.2%	99.3%	99.3%
75% load	95.6%	95.9%	95.8%	96.6%	96.6%	96.6%	99.2%	99.3%	99.3%
100% load	95.0%	95.4%	95.2%	96.0%	96.1%	96.1%	99.2%	99.3%	99.2%

## Derating Due to Load Power Factor

0.7 leading to 0.7 lagging without derating.

UPS rating	UPS output					
	Lagging			Leading		
PF=1	PF=0.7	PF=0.8	PF=0.9	PF=0.9	PF=0.8	PF=0.7
100 kVA/kW	100 kVA/70 kW	100 kVA/80 kW	100 kVA/90 kW	100 kVA/90 kW	100 kVA/80 kW	100 kVA/70 kW
150 kVA/kW	150 kVA/105 kW	150 kVA/120 kW	150 kVA/135 kW	150 kVA/135 kW	150 kVA/120 kW	150 kVA/105 kW
200 kVA/kW	200 kVA/140 kW	200 kVA/160 kW	200 kVA/180 kW	200 kVA/180 kW	200 kVA/160 kW	200 kVA/140 kW
250 kVA/kW	250 kVA/175 kW	250 kVA/200 kW	250 kVA/225 kW	250 kVA/225 kW	250 kVA/200 kW	250 kVA/175 kW

# Batteries

## End of Discharge Voltage

The voltage is 1.6 to 1.75 per cell depending on discharge ratio.

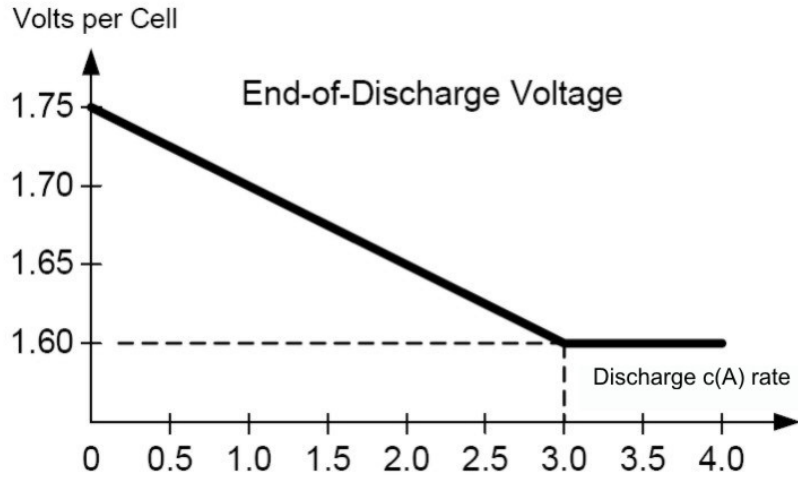

## Standard VRLA Voltage Levels

Standard VRLA Voltage Levels  
(at nominal temperature)

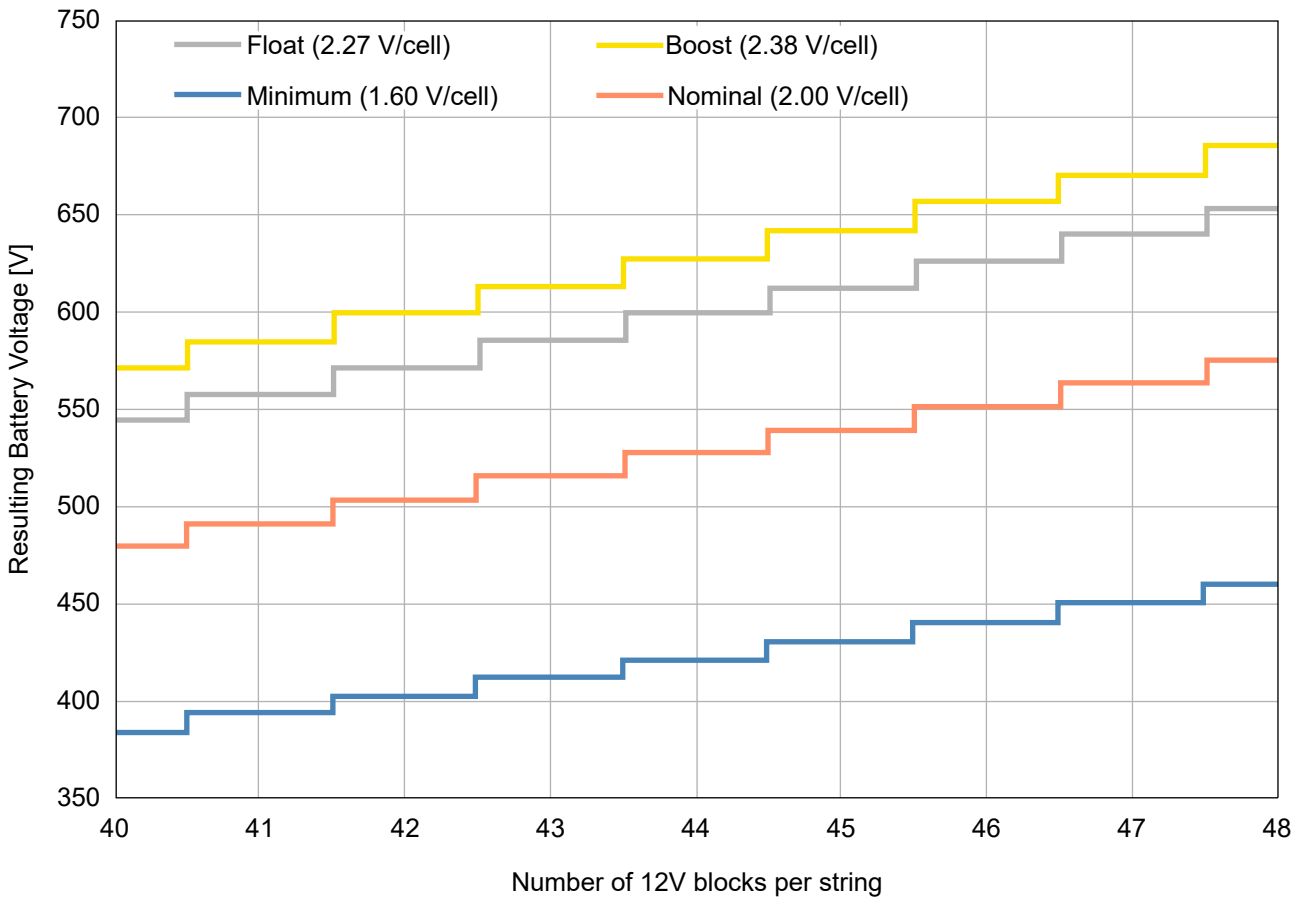

**NOTE:** Specific configurations may differ from the general constraint shown above.

# Compliance

Safety	IEC 62040-1:2017, Edition 2.0, Uninterruptible power systems (UPS) – Part 1: Safety requirements
EMC	IEC 62040-2:2016, Edition 3.0, Uninterruptible power systems (UPS) – Part 2: Electromagnetic compatibility (EMC) requirements. IEC 62040-2:2005-10, Edition 2.0, Uninterruptible Power Systems (UPS) – Part 2: Electromagnetic compatibility (EMC) requirements
Performance	IEC 62040-3: 2021-03, Edition 3.0, Uninterruptible Power Systems (UPS) - Part 3: Method of specifying the performance and test requirements
Transportation	IEC TR 60721-4-2: 2001 Level 2M2
Pollution degree	2
Overvoltage category	III
Earthing system	TN-S
Protective class	I

## Communication and Management

Local area network	1 Gbps – 1 port as default
Modbus	Modbus (SCADA)
Output relays	5 x SELV configurable
Input contacts	4 x SELV configurable
Standard control panel	7 inch touchscreen display
Audible alarm	Yes
Emergency Power Off (EPO)	Options: <ul style="list-style-type: none"> <li>• Normally Closed (NC) with 24 VDC external supply</li> <li>• Normally Open (NO) with 24 VDC external supply</li> <li>• Normally Closed (NC)/Normally Open (NO)</li> <li>• Normally Open (NO)</li> <li>• Normally Closed (NC)</li> </ul>
External switchgear	UIB UOB SSIB Ext. MBB SIB BB

# EPO

## EPO Configurations on Board 640-02383 (Terminal J6600, 1-9)

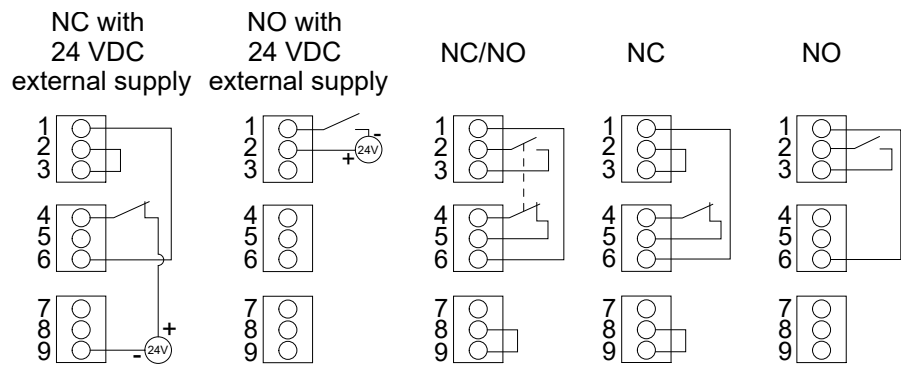

The EPO input supports 24V SELV.

**NOTE:** The default setting for the EPO activation is to turn off the inverter.

If you want the EPO activation to transfer the UPS into forced static bypass operation instead, please contact Schneider Electric.

EPO function can be set to transfer the UPS into forced static bypass operation on EPO.

# Configurable Input Contacts and Output Relays

## Input Contacts

Four input contacts are available and can be configured to indicate a given event via the display.

The input contacts support 24 VDC 10 mA. All circuits connected must have the same 0 V reference.

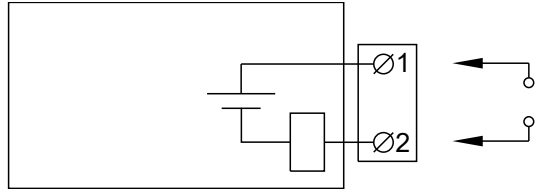

Name	Description	Location on Board 640-02383
IN _1 (input contact 1)	Configurable input contact	Terminal J3009, 1-2
IN _2 (input contact 2)		Terminal J3009, 3-4
IN _3 (input contact 3)		Terminal J3009, 5-6
IN _4 (input contact 4)		Terminal J3009, 7-8

## Output Relays

Five output relays are available and can be configured to activate on one or more events via the display.

The output relays support 24 VAC/VDC 1 A. All external circuitry must be fused with maximum 1 A fast acting fuses.

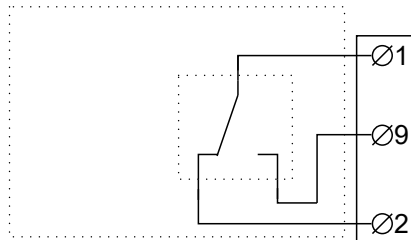

Name	Description	Location on Board 640-02383
OUT _1 (output relay 1)	Configurable output relay	Terminal J3001, 1 (Comm), 9 (NO), 2 (NC)
OUT _2 (output relay 2)		Terminal J3001, 10 (Comm), 3 (NO), 11 (NC)
OUT _3 (output relay 3)		Terminal J3001, 4 (Comm), 12 (NO), 5 (NC)
OUT _4 (output relay 4)		Terminal J3001, 13 (Comm), 6 (NO), 14 (NC)
OUT _5 (output relay 5)		Terminal J3001, 7 (Comm), 15 (NO), 8 (NC)



# Requirements for a Third Party Battery Solution

Battery breaker boxes or battery breaker kits from Schneider Electric are recommended for the battery interface. Please contact Schneider Electric for more information.

## Third Party Battery Breaker Requirements

**⚡ ⚠ DANGER**

**HAZARD OF ELECTRIC SHOCK, EXPLOSION, OR ARC FLASH**

- All selected battery breakers must be equipped with instantaneous trip functionality with an undervoltage release coil or a shunt trip release coil.
- Trip delay must be set to zero on all battery breakers.

**Failure to follow these instructions will result in death or serious injury.**

**NOTE:** There are more factors to consider when selecting a battery breaker than the requirements listed below. Please contact Schneider Electric for more information.

### Design Requirements for Battery Breaker

Battery breaker rated DC voltage > Normal battery voltage	The normal voltage of the battery configuration is defined as the highest nominal occurring battery voltage. This can be equivalent to the float voltage which may be defined as <b>number of battery blocks x number of cells x cell float voltage</b> .
Battery breaker rated DC current > Rated discharge battery current	This current is controlled by the UPS and must include maximum discharge current. This will typically be the current at the end of discharge (minimum operation DC voltage or in overload condition or a combination).
DC landings	Two DC landings for DC cables (DC+ and DC-) are required.
AUX switches for monitoring	One AUX switch must be installed in each battery breaker and connected to the UPS. The UPS can monitor up to four battery breakers.
Short-circuit breaking capability	The short-circuit breaking capability must be higher than the short-circuit DC current of the (largest) battery configuration.
Minimum trip current	The minimum short-circuit current to trip the battery breaker must match the (smallest) battery configuration, to make the breaker trip in case of a short circuit, up to the end of its life time.

## Guidance for Organizing Battery Cables

**NOTE:** For 3rd party batteries, use only high rate batteries for UPS applications.

**NOTE:** When the battery bank is placed remotely, the organizing of the cables is important to reduce voltage drop and inductance. The distance between the battery bank and the UPS must not exceed 200 m (656 ft). Contact Schneider Electric for installations with a longer distance.

**NOTE:** To minimize the risk of electromagnetic radiation, it is highly recommended to follow the below guidance and to use grounded metallic tray supports.

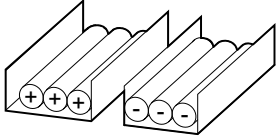
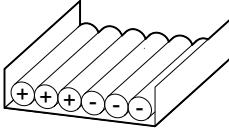
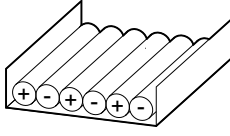
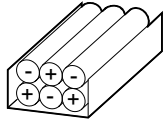
Cable Length				
<30 m	Not recommended	Acceptable	Recommended	Recommended
31–75 m	Not recommended	Not recommended	Acceptable	Recommended
76–150 m	Not recommended	Not recommended	Acceptable	Recommended
151–200 m	Not recommended	Not recommended	Not recommended	Recommended

# Specifications

## Specifications for 100 kW UPS

	Voltage (V)	380	400	415
Input	Connections	L1, L2, L3, N, PE (single mains) L1, L2, L3, PE (dual mains) <sup>1</sup>		
	Input voltage range at full load (V)	304-456 <sup>2</sup>	320-460	332-477
	Frequency (Hz)	40-70		
	Nominal input current (A)	160	152	147
	Maximum input current (A)	200	190	190
	Total harmonic distortion (THDI)	≤ 3% for linear load		
	Input power factor	> 0.99 (full load)		
	Maximum short circuit rating	Rated conditional short-circuit current I <sub>cc</sub> = 10 kA RMS Device: Refer to Required Upstream Protection, page 35.		
	Ramp-in	Programmable and adaptive 1-40 seconds		
	Protection	Built-in backfeed protection and fuses		
Bypass	Connections	L1, L2, L3, N, PE		
	Minimum bypass voltage (V)	342	360	374
	Maximum bypass voltage (V)	418	440	457
	Frequency (Hz)	50 or 60		
	Frequency range (Hz)	±1 Hz, ±3 Hz, ±10 Hz (user selectable)		
	Nominal bypass current (A)	155	147	142
	Maximum short circuit rating	Rated conditional short-circuit current I <sub>cc</sub> = 10 kA RMS Device: Refer to Required Upstream Protection, page 35.		
	Protection	Dry contact signal for backfeed protection		
Output	Connections	L1, L2, L3, N, PE		
	Output voltage regulation	±1% (symmetrical load) ±3% (asymmetrical load)		
	Overload capacity	Normal operation: ≤125% for 10 minutes; ≤150% for 1 minute Bypass operation: ≤110% continuous; ≤125% for 10 minutes; ≤150% for 1 minute Battery operation: ≤125% for 1 minute; ≤150% for 1 second		
	Output power factor	1		
	Nominal output current (A)	152	145	140
	Total harmonic distortion (THDU)	1% (linear load) 3% (non-linear load)		
	Output frequency (Hz)	50/60 Hz bypass synchronized 50/60 Hz ± 0.1% free-running		
	Slew rate (Hz/sec)	Programmable to 0.25, 0.5, 1, 2, 4, 6 Hz/second		
	Load power factor	0.7 leading to 0.7 lagging without derating		
	Load crest factor	2.5		
	Output short circuit current (inverter)	320 A/220 ms		

1. Common N with bypass.
2. Measured at 30 °C.

	<b>Voltage (V)</b>	<b>380</b>	<b>400</b>	<b>415</b>
<b>Battery</b>	Charging power in % of output power	5% to 60% (selectable)		
	Maximum charging power (kW)	60		
	Nominal battery voltage (VDC)	480 to 576		
	Nominal float voltage (VDC)	545 to 654		
	End of discharge voltage (full load) (VDC)	384 to 461		
	Temperature compensation (per cell)	-3.3 mV/°C/cell for T ≥ 25 °C 0 mV/°C/cell for T < 25 °C		
	Battery current at full load and nominal battery voltage (A)	222		
	Battery current at full load and minimum battery voltage (A)	260		
	Ripple current	< 5% C20 (5-minute runtime)		
	Battery test	Manual/automatic (selectable)		
	Maximum short circuit rating	25 kA		

# Specifications for 150 kW UPS

	Voltage (V)	380	400	415
<b>Input</b>	Connections	L1, L2, L3, N, PE (single mains) L1, L2, L3, PE (dual mains) <sup>3</sup>		
	Input voltage range at full load (V)	304-456 <sup>4</sup>	320-460	332-477
	Frequency (Hz)	40-70		
	Nominal input current (A)	240	228	220
	Maximum input current (A)	300	285	285
	Total harmonic distortion (THDI)	≤ 3% for linear load		
	Input power factor	> 0.99 (full load)		
	Maximum short circuit rating	Rated conditional short-circuit current I <sub>cc</sub> = 10 kA RMS Device: Refer to Required Upstream Protection, page 35.		
	Ramp-in	Programmable and adaptive 1-40 seconds		
	Protection	Built-in backfeed protection and fuses		
<b>Bypass</b>	Connections	L1, L2, L3, N, PE		
	Minimum bypass voltage (V)	342	360	374
	Maximum bypass voltage (V)	418	440	457
	Frequency (Hz)	50 or 60		
	Frequency range (Hz)	±1 Hz, ±3 Hz, ±10 Hz (user selectable)		
	Nominal bypass current (A)	232	220	212
	Maximum short circuit rating	Rated conditional short-circuit current I <sub>cc</sub> = 10 kA RMS Device: Refer to Required Upstream Protection, page 35.		
	Protection	Dry contact signal for backfeed protection		
<b>Output</b>	Connections	L1, L2, L3, N, PE		
	Output voltage regulation	±1% (symmetrical load) ±3% (asymmetrical load)		
	Overload capacity	Normal operation: ≤125% for 10 minutes; ≤150% for 1 minute Bypass operation: ≤110% continuous; ≤125% for 10 minutes; ≤150% for 1 minute Battery operation: ≤125% for 1 minute; ≤150% for 1 second		
	Output power factor	1		
	Nominal output current (A)	228	217	209
	Total harmonic distortion (THDU)	1% (linear load) 3% (non-linear load)		
	Output frequency (Hz)	50/60 Hz bypass synchronized 50/60 Hz ± 0.1% free-running		
	Slew rate (Hz/sec)	Programmable to 0.25, 0.5, 1, 2, 4, 6 Hz/second		
	Load power factor	0.7 leading to 0.7 lagging without derating		
	Load crest factor	2.5		
Output short circuit current (inverter)	480 A/220 ms			

3. Common N with bypass. For dual mains systems with upstream 4-pole breakers: install an N connection with the UPS input cables (L1, L2, L3, N, PE) and connect Input N with Bypass N.  
4. Measured at 30 °C.

	<b>Voltage (V)</b>	<b>380</b>	<b>400</b>	<b>415</b>
<b>2.5Battery</b>	Charging power in % of output power	5% to 60% (selectable)		
	Maximum charging power (kW)	90		
	Nominal battery voltage (VDC)	480 to 576		
	Nominal float voltage (VDC)	545 to 654		
	End of discharge voltage (full load) (VDC)	384 to 461		
	Temperature compensation (per cell)	-3.3 mV/°C/cell for T ≥ 25 °C 0 mV/°C/cell for T < 25 °C		
	Battery current at full load and nominal battery voltage (A)	333		
	Battery current at full load and minimum battery voltage (A)	390		
	Ripple current	< 5% C20 (5-minute runtime)		
	Battery test	Manual/automatic (selectable)		
	Maximum short circuit rating	25 kA		

# Specifications for 200 kW UPS

	Voltage (V)	380	400	415
<b>Input</b>	Connections	L1, L2, L3, N, PE (single mains) L1, L2, L3, PE (dual mains) <sup>5</sup>		
	Input voltage range at full load (V)	304-456 <sup>6</sup>	320-460	332-477
	Frequency (Hz)	40-70		
	Nominal input current (A)	320	304	293
	Maximum input current (A)	400	380	380
	Total harmonic distortion (THDI)	≤ 3% for linear load		
	Input power factor	> 0.99 (full load)		
	Maximum short circuit rating	Rated conditional short-circuit current I <sub>cc</sub> = 10 kA RMS Device: Refer to Required Upstream Protection, page 35.		
	Ramp-in	Programmable and adaptive 1-40 seconds		
	Protection	Built-in backfeed protection and fuses		
<b>Bypass</b>	Connections	L1, L2, L3, N, PE		
	Minimum bypass voltage (V)	342	360	374
	Maximum bypass voltage (V)	418	440	457
	Frequency (Hz)	50 or 60		
	Frequency range (Hz)	±1 Hz, ±3 Hz, ±10 Hz (user selectable)		
	Nominal bypass current (A)	309	294	283
	Maximum short circuit rating	Rated conditional short-circuit current I <sub>cc</sub> = 10 kA RMS Device: Refer to Required Upstream Protection, page 35.		
	Protection	Dry contact signal for backfeed protection		
<b>Output</b>	Connections	L1, L2, L3, N, PE		
	Output voltage regulation	±1% (symmetrical load) ±3% (asymmetrical load)		
	Overload capacity	Normal operation: ≤125% for 10 minutes; ≤150% for 1 minute Bypass operation: ≤110% continuous; ≤125% for 10 minutes; ≤150% for 1 minute Battery operation: ≤125% for 1 minute; ≤150% for 1 second		
	Output power factor	1		
	Nominal output current (A)	304	289	279
	Total harmonic distortion (THDU)	1% (linear load) 3% (non-linear load)		
	Output frequency (Hz)	50/60 Hz bypass synchronized 50/60 Hz ± 0.1% free-running		
	Slew rate (Hz/sec)	Programmable to 0.25, 0.5, 1, 2, 4, 6 Hz/second		
	Load power factor	0.7 leading to 0.7 lagging without derating		
	Load crest factor	2.5		
Output short circuit current (inverter)	640 A/220 ms			

5. Common N with bypass. For dual mains systems with upstream 4-pole breakers: install an N connection with the UPS input cables (L1, L2, L3, N, PE) and connect Input N with Bypass N.  
6. Measured at 30 °C.

	<b>Voltage (V)</b>	<b>380</b>	<b>400</b>	<b>415</b>
<b>Battery</b>	Charging power in % of output power	5% to 60% (selectable)		
	Maximum charging power (kW)	120		
	Nominal battery voltage (VDC)	480 to 576		
	Nominal float voltage (VDC)	545 to 654		
	End of discharge voltage (full load) (VDC)	384 to 461		
	Temperature compensation (per cell)	-3.3 mV/°C/cell for T ≥ 25 °C 0 mV/°C/cell for T < 25 °C		
	Battery current at full load and nominal battery voltage (A)	444		
	Battery current at full load and minimum battery voltage (A)	520		
	Ripple current	< 5% C20 (5-minute runtime)		
	Battery test	Manual/automatic (selectable)		
	Maximum short circuit rating	25 kA		



# Specifications for 250 kW UPS

	Voltage (V)	380	400	415
<b>Input</b>	Connections	L1, L2, L3, N, PE (single mains) L1, L2, L3, PE (dual mains) <sup>7</sup>		
	Input voltage range at full load (V)	304-456 <sup>8</sup>	320-460	332-477
	Frequency (Hz)	40-70		
	Nominal input current (A)	400	380	367
	Maximum input current (A)	500	475	475
	Total harmonic distortion (THDI)	≤ 3% for linear load		
	Input power factor	> 0.99 (full load)		
	Maximum short circuit rating	Rated conditional short-circuit current I <sub>cc</sub> = 10 kA RMS Device: Refer to Required Upstream Protection, page 35.		
	Ramp-in	Programmable and adaptive 1-40 seconds		
	Protection	Built-in backfeed protection and fuses		
<b>Bypass</b>	Connections	L1, L2, L3, N, PE		
	Minimum bypass voltage (V)	342	360	374
	Maximum bypass voltage (V)	418	440	457
	Frequency (Hz)	50 or 60		
	Frequency range (Hz)	±1 Hz, ±3 Hz, ±10 Hz (user selectable)		
	Nominal bypass current (A)	386	367	354
	Maximum short circuit rating	Rated conditional short-circuit current I <sub>cc</sub> = 10 kA RMS Device: Refer to Required Upstream Protection, page 35.		
	Protection	Dry contact signal for backfeed protection		
<b>Output</b>	Connections	L1, L2, L3, N, PE		
	Output voltage regulation	±1% (symmetrical load) ±3% (asymmetrical load)		
	Overload capacity	Normal operation: ≤125% for 10 minutes; ≤150% for 1 minute Bypass operation: ≤110% continuous; ≤125% for 10 minutes; ≤150% for 1 minute Battery operation: ≤125% for 1 minute; ≤150% for 1 second		
	Output power factor	1		
	Nominal output current (A)	380	361	348
	Total harmonic distortion (THDU)	1% (linear load) 3% (non-linear load)		
	Output frequency (Hz)	50/60 Hz bypass synchronized 50/60 Hz ± 0.1% free-running		
	Slew rate (Hz/sec)	Programmable to 0.25, 0.5, 1, 2, 4, 6 Hz/second		
	Load power factor	0.7 leading to 0.7 lagging without derating		
	Load crest factor	2.5		
Output short circuit current (inverter)	800 A/220 ms			

7. Common N with bypass. For dual mains systems with upstream 4-pole breakers: install an N connection with the UPS input cables (L1, L2, L3, N, PE) and connect Input N with Bypass N.  
8. Measured at 30 °C.

	<b>Voltage (V)</b>	<b>380</b>	<b>400</b>	<b>415</b>
<b>Battery</b>	Charging power in % of output power	5% to 60% (selectable)		
	Maximum charging power (kW)	150		
	Nominal battery voltage (VDC)	480 to 576		
	Nominal float voltage (VDC)	545 to 654		
	End of discharge voltage (full load) (VDC)	384 to 461		
	Temperature compensation (per cell)	-3.3 mV/°C/cell for T ≥ 25 °C 0 mV/°C/cell for T < 25 °C		
	Battery current at full load and nominal battery voltage (A)	555		
	Battery current at full load and minimum battery voltage (A)	650		
	Ripple current	< 5% C20 (5-minute runtime)		
	Battery test	Manual/automatic (selectable)		
	Maximum short circuit rating	25 kA		

## Required Upstream Protection

**⚠️ ⚠️ DANGER**

**HAZARD OF ELECTRIC SHOCK, EXPLOSION, OR ARC FLASH**

The upstream protection must use the required 3-pole breakers OR 4-pole breakers listed below. Follow the national or local requirements to select 3-pole or 4-pole breakers.

**Failure to follow these instructions will result in death or serious injury.**

## Required 3-Pole Upstream Protection

UPS rating	100 kW		150 kW	
	Input	Bypass	Input	Bypass
Breaker type	NSX250H TM200 (C25H3TM200)	NSX160H TM160 (C16H3TM160)	NSX400H MiC.2.3 (C40H32D400)	NSX250H TM250 (C25H3TM250)
Io	200	160	320	250
I <sub>r</sub>	200	160	0.95	250
I <sub>sd</sub>	5 - 10	1250 (fixed)	1.5 - 10	5 - 10

UPS rating	200 kW		250 kW	
	Input	Bypass	Input	Bypass
Breaker type	NSX400H MiC.2.3 (C40H32D400)	NSX400H MiC.2.3 (C40H32D400)	NSX630H MiC.2.3 (C63H32D630)	NSX400H MiC.2.3 (C40H32D400)
Io	400	320	500	400
I <sub>r</sub>	1	1	1	1
I <sub>sd</sub>	1.5 - 10	1.5 - 10	1.5 - 10	1.5 - 10

## Required 4-Pole Upstream Protection

UPS rating	100 kW		150 kW	
	Input	Bypass	Input	Bypass
Breaker type	NSX250H TM200 (C25H4TM200)	NSX400H MiC.2.3 (C40H42D400)	NSX400H MiC.2.3 (C40H42D400)	NSX400H MiC.2.3 (C40H42D400)
Io	200	280	320	280
I <sub>r</sub>	200	0.95	0.95	0.95
I <sub>sd</sub>	1.5 - 10	1.5 - 10	1.5 - 10	1.5 - 10

UPS rating	200 kW		250 kW	
	Input	Bypass	Input	Bypass
Breaker type	NSX400H MiC.2.3 (C40H42D400)	NSX400H MiC.2.3 (C40H42D400)	NSX630H MiC.2.3 (C63H42D630)	NSX400H MiC.2.3 (C40H42D400)
Io	400	320	500	400
I <sub>r</sub>	1	1	1	1
I <sub>sd</sub>	1.5 - 10	1.5 - 10	1.5 - 10	1.5 - 10

## Recommended Cables Sizes

**⚡⚠ DANGER**

**HAZARD OF ELECTRIC SHOCK, EXPLOSION, OR ARC FLASH**

All wiring must comply with all applicable national and/or electrical codes. The maximum allowable cable size is 185 mm<sup>2</sup>.

**Failure to follow these instructions will result in death or serious injury.**

**NOTE:** Overcurrent protection is to be provided by external devices.

Cable sizes in this manual are based on table A.52-5 of IEC 60364-5-52 with the following assertions:

- 90 °C conductors
- An ambient temperature of 30 °C
- Use of copper conductors
- Installation method C

PE size is based on table 54.3 of IEC 60364-5-54.

If the ambient temperature is greater than 30 °C, larger conductors are to be used in accordance with the correction factors of the IEC.

**NOTE:** Battery cables are sized according to 40 battery blocks. Contact Schneider Electric for cable sizes for systems with more than 40 battery blocks.

**NOTE:** It is recommended to use the provided screws to connect the power cables.

### 100 kW UPS

Copper	Cable size per phase (mm <sup>2</sup> )	Neutral cable size (mm <sup>2</sup> )	PE cable size (mm <sup>2</sup> )
Input	70	2 x 70	35
Bypass	70 (for 3-pole upstream protection) 2 x 70 (for 4-pole upstream protection)		35
Output	70	2 x 70	35
Battery	95	95	50

### 150 kW UPS

Copper	Cable size per phase (mm <sup>2</sup> )	Neutral cable size (mm <sup>2</sup> )	PE cable size (mm <sup>2</sup> )
Input	120	2 x 70	70
Bypass	120 (for 3-pole upstream protection) 2 x 70 (for 4-pole upstream protection)		70
Output	120	2 x 70	70
Battery	2 x 70	2 x 70	70

## 200 kW UPS

Copper	Cable size per phase (mm <sup>2</sup> )	Neutral cable size (mm <sup>2</sup> )	PE cable size (mm <sup>2</sup> )
Input	2 x 95	2 x 95	95
Bypass	2 x 70		70
Output	2 x 70	2 x 70	70
Battery	2 x 120	2 x 120	120

## 250 kW UPS

Copper	Cable size per phase (mm <sup>2</sup> )	Neutral cable size (mm <sup>2</sup> )	PE cable size (mm <sup>2</sup> )
Input	2 x 120	2 x 120	120
Bypass	2 x 95		95
Output	2 x 95	2 x 95	95
Battery	2 x 150	2 x 150	150

## Recommended Bolt and Lug Sizes

Cable size (mm <sup>2</sup> )	Bolt size	Cable lug type
16	M8x40 mm	TLK 16-8
25	M8x40 mm	TLK 25-8
35	M8x40 mm	TLK 35-8
50	M8x40 mm	TLK 50-8
70	M8x40 mm	TLK 70-8
95	M8x40 mm	TLK 95-8
120	M8x40 mm	TLK 120-8
150	M8x40 mm	TLK 150-8
185	M8x40 mm	TLK 185-8

## Torque Specifications

Bolt size	Torque
M4	1.7 Nm
M6	5 Nm
M8	17.5 Nm
M10	30 Nm
M12	50 Nm

# Physical

## UPS Shipping Weights and Dimensions

Commercial reference	Weight kg	Height mm	Width mm	Depth mm	Number of preinstalled power modules in the UPS	Number of extra power modules that can be ordered <sup>9</sup>
E3MUPS100K150HIN	354	2130	750	1190	2	1
E3MUPS100K250HIN	360	2130	750	1190	2	3

## Power Module Shipping Weights and Dimensions

**NOTE:** For N+1 UPS models the weight increases with 28 kg for the redundant power module.

Commercial reference	Weight kg	Height mm	Width mm	Depth mm
EMPM50KH	33	280	590	850

## UPS Weights and Dimensions

Type	Weight kg	Height mm	Width mm	Depth mm
100 kW	306	1970	608	1008
100 kW with N+1 power module	334	1970	608	1008
150 kW	334	1970	608	1008
150 kW with N+1 power module	367	1970	608	1008
200 kW	367	1970	608	1008
200 kW with N+1 power module	395	1970	608	1008
250 kW	395	1970	608	1008

9. See Power Module Shipping Weights and Dimensions, page 38 for shipping weight and dimensions for the extra power modules which are shipped separately.

## Clearance

**NOTE:** Clearance dimensions are published for airflow and service access only. Consult with the local safety codes and standards for additional requirements in your local area.

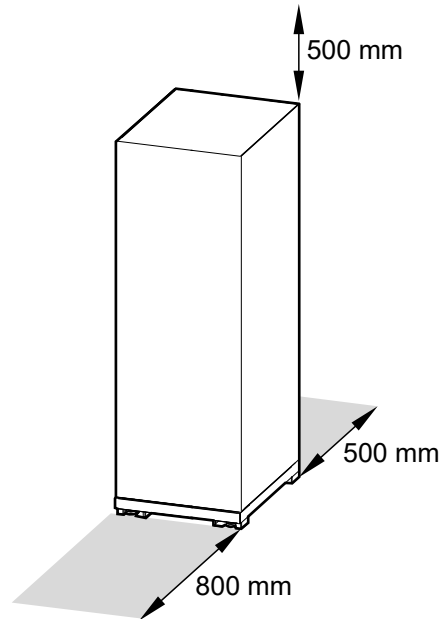

# Environment

	Operating	Storage
Temperature	0 °C to 50 °C with load derating above 40 °C <sup>10</sup>	-25 °C to 55 °C
Relative humidity	0-95% non-condensing	0-95% non-condensing
Elevation	Designed for operation in 0-3000 m elevation.  Derating required from 1000-3000 m with forced air cooling: Up to 1000 m: 1.000 Up to 1500 m: 0.975 Up to 2000 m: 0.950 Up to 2500 m: 0.925 Up to 3000 m: 0.900	
Audible noise <sup>11</sup>	68 dB at 70% load  74 dB at 100% load	
Protection class	IP20	
Color	White	

10. For temperatures between 40 °C and 50 °C, derate the load power rating to 75%.

11. Values are measured for the maximum configuration.



# Heat Dissipation in BTU/hr

100 kW	Normal operation			ECO mode			Battery operation		
Voltage (V)	380	400	415	380	400	415	380	400	415
25% load	3647	3647	3647	1036	862	862	2820	2911	3002
50% load	7109	6924	6924	1549	1376	1203	5640	5458	5640
75% load	11499	11220	10941	2064	1804	1804	9557	9007	9282
100% load	17204	16453	16828	2752	2060	2060	14588	13478	14217

150 kW	Normal operation			ECO mode			Battery operation		
Voltage (V)	380	400	415	380	400	415	380	400	415
25% load	5471	5332	5471	1293	1293	1293	4230	4367	4504
50% load	10386	10109	10386	1804	2064	1804	8460	8460	8460
75% load	17248	16411	16829	2706	2706	2706	14335	13923	13923
100% load	26371	24679	24679	4128	3608	3608	21882	20771	21326

200 kW	Normal operation			ECO mode			Battery operation		
Voltage (V)	380	400	415	380	400	415	380	400	415
25% load	7109	7109	7294	1723	1723	1723	5640	5640	5822
50% load	138479	13478	13847	2752	2405	2752	11280	10916	11280
75% load	229979	21882	22439	3608	3608	3608	18564	18014	18564
100% load	35162	33656	32905	5504	4811	4811	29176	27695	28435

250 kW	Normal operation			ECO mode			Battery operation		
Voltage (V)	380	400	415	380	400	415	380	400	415
25% load	8886	8655	8886	2154	1937	2154	6823	6823	7050
50% load	17309	16848	17309	3440	3007	3007	13191	13645	13191
75% load	29446	27352	28049	5160	4510	4510	22518	22518	22518
100% load	44897	41132	43010	6879	6013	6879	35543	34619	34619

# Drawings

**NOTE:** A comprehensive set of drawings is available on [www.se.com](http://www.se.com).

**NOTE:** These drawings are for reference ONLY – subject to change without notice.

## Easy UPS 3M Advanced 100-250 kW 400 V UPS

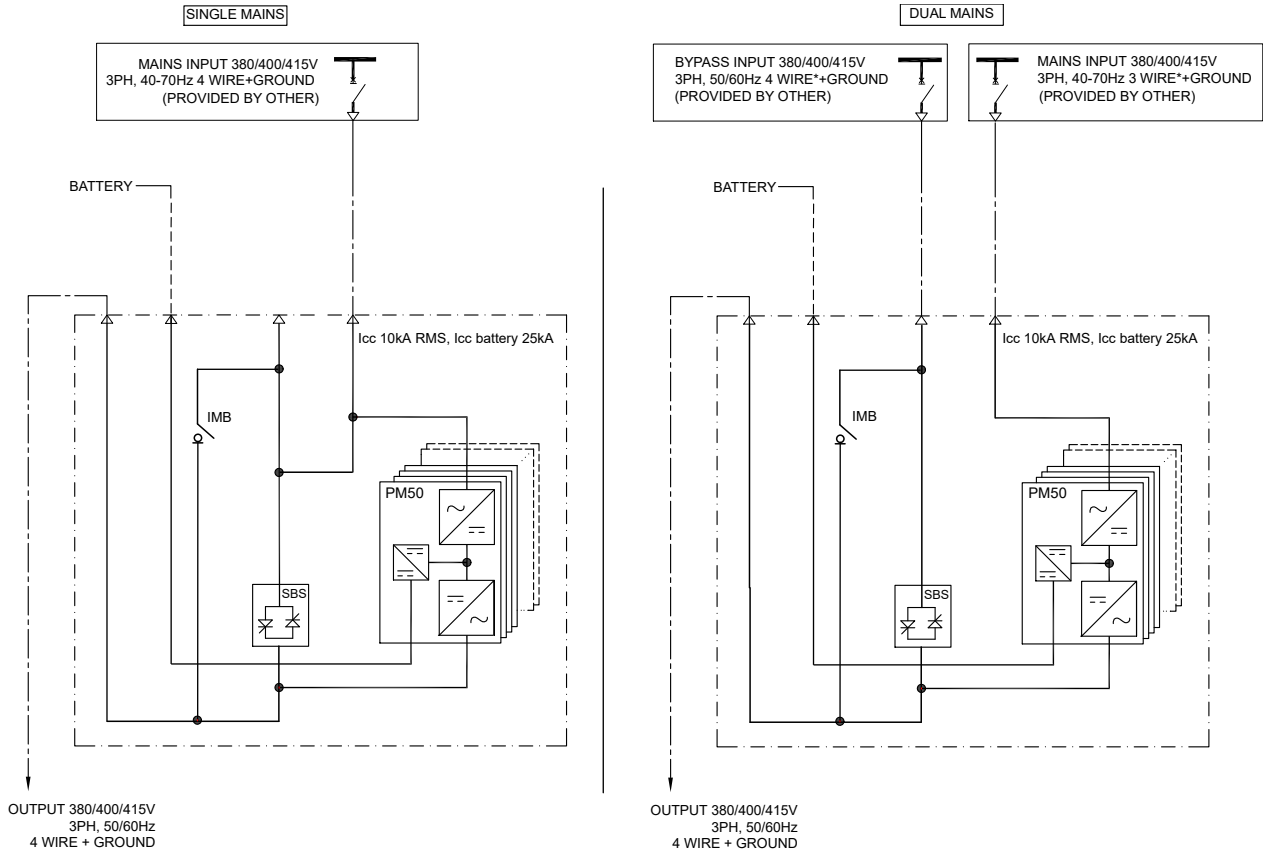

# Options

## Configuration Options

- Single or dual mains
- Default top cable entry.
- ECO mode
- EcoStruxure IT compatible
- Generator compatible

## Hardware Options

**NOTE:** All hardware options listed here may not be available in all regions.

### Power Module

- Power module 50 kW (EMPM50KH)

### Battery Breaker Box

Wall mounted battery breaker box for use with third party battery solutions.

- 100-300 kW battery breaker box with one battery breaker (GVBBB630EL-1CB)
- 250-500 kW battery breaker box with two battery breakers (GVBBB630EL-2CB)

### Battery Breaker Kit

Battery breaker kit for use with empty battery cabinets or third party battery solutions.

- 100-300 kW battery breaker kit (GVBBK630EL)

### Maintenance Bypass Panel

Maintenance bypass panel for complete isolation of the UPS during service operations.

- 60-400 kW maintenance bypass panel (E3MBP60K400H)

### Optional Installation Kits

- Battery temperature sensor (SP3OPT006)

### Optional Network Management Card

- Network management card 3 (AP9640)
- UPS network management card 3 with environmental monitoring (AP9641)

### Temperature Sensors

- Temperature sensor (AP9335T) for network management card (AP9641)
- Temperature sensor (AP9335TH) for network management card (AP9641)

# Limited Factory Warranty

## One-Year Factory Warranty

The limited warranty provided by Schneider Electric in this Statement of Limited Factory Warranty applies only to products you purchase for your commercial or industrial use in the ordinary course of your business.

## Terms of Warranty

Schneider Electric warrants that the product shall be free from defects in materials and workmanship for a period of one year from the date of product start-up when start-up is performed by Schneider Electric-authorized service personnel and occurs within six months of the Schneider Electric shipment date. This warranty covers repairing or replacing any defective parts including on-site labor and travel. In the event that the product fails to meet the foregoing warranty criteria, the warranty covers repairing or replacing defective parts at the sole discretion of Schneider Electric for a period of one year from the shipment date. For Schneider Electric cooling solutions, this warranty does not cover circuit breaker resetting, loss of refrigerant, consumables, or preventive maintenance items. Repair or replacement of a defective product or part thereof does not extend the original warranty period. Any parts furnished under this warranty may be new or factory-remanufactured.

## Non-transferable Warranty

This warranty is extended to the first person, firm, association or corporation (herein referred to by "You" or "Your") for whom the Schneider Electric product specified herein has been purchased. This warranty is not transferable or assignable without the prior written permission of Schneider Electric.

## Assignment of Warranties

Schneider Electric will assign you any warranties which are made by manufacturers and suppliers of components of the Schneider Electric product and which are assignable. Any such warranties are assigned "AS IS" and Schneider Electric makes no representation as to the effectiveness or extent of such warranties, assumes no responsibility for any matters which may be warranted by such manufacturers or suppliers and extends no coverage under this Warranty to such components.

## Drawings, Descriptions

Schneider Electric warrants for the warranty period and on the terms of the warranty set forth herein that the Schneider Electric product will substantially conform to the descriptions contained in the Schneider Electric Official Published Specifications or any of the drawings certified and agreed to by contract with Schneider Electric if applicable thereto ("Specifications"). It is understood that the Specifications are not warranties of performance and not warranties of fitness for a particular purpose.

## Exclusions

Schneider Electric shall not be liable under the warranty if its testing and examination disclose that the alleged defect in the product does not exist or was caused by end user or any third person misuse, negligence, improper installation or testing. Further, Schneider Electric shall not be liable under the warranty for unauthorized attempts to repair or modify wrong or inadequate electrical voltage

or connection, inappropriate on-site operation conditions, corrosive atmosphere, repair, installation, start-up by non-Schneider Electric designated personnel, a change in location or operating use, exposure to the elements, Acts of God, fire, theft, or installation contrary to Schneider Electric recommendations or specifications or in any event if the Schneider Electric serial number has been altered, defaced, or removed, or any other cause beyond the range of the intended use.

THERE ARE NO WARRANTIES, EXPRESS OR IMPLIED, BY OPERATION OF LAW OR OTHERWISE, OF PRODUCTS SOLD, SERVICED OR FURNISHED UNDER THIS AGREEMENT OR IN CONNECTION HEREWITH. SCHNEIDER ELECTRIC DISCLAIMS ALL IMPLIED WARRANTIES OF MERCHANTABILITY, SATISFACTION AND FITNESS FOR A PARTICULAR PURPOSE. SCHNEIDER ELECTRIC EXPRESS WARRANTIES WILL NOT BE ENLARGED, DIMINISHED, OR AFFECTED BY AND NO OBLIGATION OR LIABILITY WILL ARISE OUT OF, SCHNEIDER ELECTRIC RENDERING OF TECHNICAL OR OTHER ADVICE OR SERVICE IN CONNECTION WITH THE PRODUCTS. THE FOREGOING WARRANTIES AND REMEDIES ARE EXCLUSIVE AND IN LIEU OF ALL OTHER WARRANTIES AND REMEDIES. THE WARRANTIES SET FORTH ABOVE CONSTITUTE SCHNEIDER ELECTRIC SOLE LIABILITY AND PURCHASER'S EXCLUSIVE REMEDY FOR ANY BREACH OF SUCH WARRANTIES. SCHNEIDER ELECTRIC WARRANTIES RUN ONLY TO PURCHASER AND ARE NOT EXTENDED TO ANY THIRD PARTIES.

IN NO EVENT SHALL SCHNEIDER ELECTRIC, ITS OFFICERS, DIRECTORS, AFFILIATES OR EMPLOYEES BE LIABLE FOR ANY FORM OF INDIRECT, SPECIAL, CONSEQUENTIAL OR PUNITIVE DAMAGES, ARISING OUT OF THE USE, SERVICE OR INSTALLATION, OF THE PRODUCTS, WHETHER SUCH DAMAGES ARISE IN CONTRACT OR TORT, IRRESPECTIVE OF FAULT, NEGLIGENCE OR STRICT LIABILITY OR WHETHER SCHNEIDER ELECTRIC HAS BEEN ADVISED IN ADVANCE OF THE POSSIBILITY OF SUCH DAMAGES, SPECIFICALLY, SCHNEIDER ELECTRIC IS NOT LIABLE FOR ANY COSTS, SUCH AS LOST PROFITS OR REVENUE, LOSS OF EQUIPMENT, LOSS OF USE OF EQUIPMENT, LOSS OF SOFTWARE, LOSS OF DATA, COSTS OF SUBSTITUANTS, CLAIMS BY THIRD PARTIES, OR OTHERWISE.

NO SALESMAN, EMPLOYEE OR AGENT OF SCHNEIDER ELECTRIC IS AUTHORIZED TO ADD TO OR VARY THE TERMS OF THIS WARRANTY. WARRANTY TERMS MAY BE MODIFIED, IF AT ALL, ONLY IN WRITING SIGNED BY AN SCHNEIDER ELECTRIC OFFICER AND LEGAL DEPARTMENT.

## Warranty Claims

Customers with warranty claims issues may access the SCHNEIDER ELECTRIC worldwide customer support network through the SCHNEIDER ELECTRIC web site: <http://www.schneider-electric.com>. Select your country from the country selection pull-down menu. Open the Support tab at the top of the web page to obtain contact information for customer support in your region.



Schneider Electric  
35 rue Joseph Monier  
92500 Rueil Malmaison  
France

+ 33 (0) 1 41 29 70 00



As standards, specifications, and design change from time to time,  
please ask for confirmation of the information given in this publication.

© 2023 – 2023 Schneider Electric. All rights reserved.

990-92226-001