

# EVlink

## Troubleshooting guide

DOCA0117EN-00

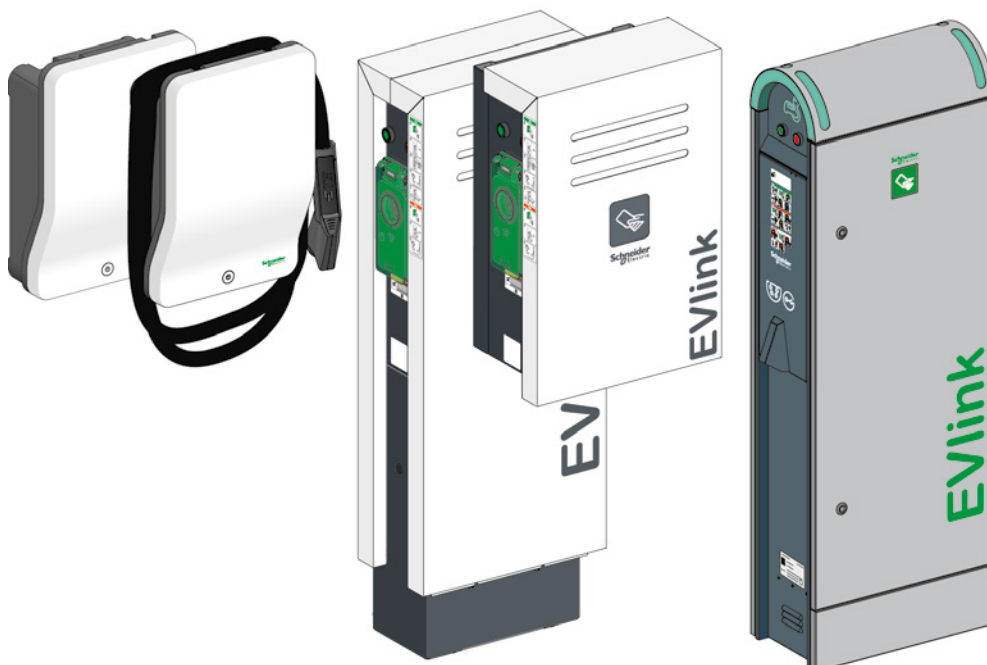

---

This document contains general descriptions and/or general technical specifications of the products mentioned. It cannot be used to determine the suitability or reliability of these products for specific user applications. It is the responsibility of each user or integrator to conduct the appropriate risk analysis in full, assessing and testing products as regards the application in which they will be used and the execution of this application. Neither Schneider Electric nor any of its affiliated companies or subsidiaries can be held responsible for incorrect use of the information contained in this document. If you have any suggestions for improvements or correction, or have found errors in this publication, please notify us.

No part of this document may be reproduced in any form or by any means, electronic or mechanical, including photocopying, without express written permission from Schneider Electric.

All relevant state, regional, and local safety regulations must be observed when installing and using this product. For reasons of safety and to ensure compliance with documented system data, only the manufacturer should perform repairs to components.

When equipment is used for applications with technical safety requirements, follow the relevant instructions.

Failure to use Schneider Electric software or approved software with our hardware products may result in injury, harm, or improper operation.

Failure to follow this instruction can result in injury or equipment damage.

© 2016 Schneider Electric. All rights reserved.



	<b>Safety information</b> .....	<b>4</b>
	<b>About this manual</b> .....	<b>5</b>
	<b>Tools and accessories required</b> .....	<b>6</b>
	<b>Application</b> .....	<b>6</b>
	<b>Product family</b> .....	<b>7</b>
<b>Chapter 1</b>	<b>First level troubleshooting with indicator lights and buttons - Without PC</b> .....	<b>8</b>
	<b>1.1 Description</b> .....	<b>8</b>
	EVlink Smart Wallbox .....	8
	EVlink Parking .....	8
	EVlink City .....	9
	<b>1.2 Charging station troubleshooting mode</b> .....	<b>9</b>
	EVlink Smart Wallbox .....	9
	EVlink Parking .....	9
	EVlink City .....	10
	<b>1.3 Reading fault codes</b> .....	<b>10</b>
	<b>1.4 First level troubleshooting</b> .....	<b>11</b>
<b>Chapter 2</b>	<b>Second level troubleshooting with a PC</b> .....	<b>13</b>
	<b>2.1 Connection to the charging station</b> .....	<b>13</b>
	EVlink Smart Wallbox .....	13
	EVlink Parking .....	13
	EVlink City .....	14
	<b>2.2 Computer configuration</b> .....	<b>14</b>
	<b>2.3 Downloading the report</b> .....	<b>15</b>
	<b>2.4 Description of the report</b> .....	<b>16</b>
	<b>2.5 Second level troubleshooting</b> .....	<b>18</b>
<b>Chapter 3</b>	<b>Returning to factory settings of the charging station</b> .....	<b>21</b>
	<b>3.1 Manually - Without PC</b> .....	<b>21</b>
	EVlink SmartWallbox.....	21
	EVlink Parking .....	22
	EVlink City - (→ 05 / 2016) .....	23
	EVlink City - (05 / 2016 →) .....	24
	<b>3.2 With PC</b> .....	<b>25</b>



## IMPORTANT INFORMATION

### NOTICE

Read these instructions carefully, and look at the equipment to become familiar with the device before trying to install, operate, repair or maintain it. The following special messages may appear throughout this documentation or on the equipment to warn of potential hazards or to call attention to information that clarifies or simplifies a procedure.



The addition of one of these symbols to a Danger safety label on a device indicates that an electrical hazard exists, which could result in death or personal injury if the instructions are not followed.



This is the safety alert symbol. It warns you of a risk of physical injury. You must comply strictly with the safety instructions associated with this symbol to avoid injuring yourself or putting your life in danger.

### DANGER

**DANGER** indicates an imminently hazardous situation, which, if not avoided, **will result** in death or serious injury.

### WARNING

**WARNING** indicates a potentially hazardous situation which, if the safety instructions are not followed, **could result** in death or serious injury.

### CAUTION

**CAUTION** indicates a potentially hazardous situation which, if the safety instructions are not followed, **could result** in slight or serious injury.

### NOTICE

**NOTICE** indicates practices that do not involve the risk of bodily injury.

## IMPORTANT NOTE

Electrical equipment should be installed, serviced, and maintained only by qualified personnel. No responsibility is assumed by Schneider Electric for any consequences arising out of the use of this equipment.



## Aim of this document

The purpose of this document is to guide you in troubleshooting:

- an EVlink Parking EVF1, EVW1, EVF2 or EVW2 charging station;
- an EVlink City EVC charging station;
- an EVlink Smart Wallbox EVB charging station.

This document tells you how to:

- carry out first level troubleshooting without PC and without opening the charging station;
- carry out second level troubleshooting with PC connected to the charging station;
- restore the factory settings of the charging station.

This document is intended for:

- commissioning technicians;
- site operators.

## Area of application

The characteristics given in this document must be identical to those provided on-line.

In accordance with our policy of continuous improvement, we may revise the content to improve the clarity and accuracy. In the event of a difference between this user manual and the information on-line, use the latter as reference.

## Related document(s)

Document title	Catalogue number
EVlink charging stations - Comissing Guide	DOCA0060EN

You can download these publications and other technical information from our website at <http://download.schneider-electric.com>.

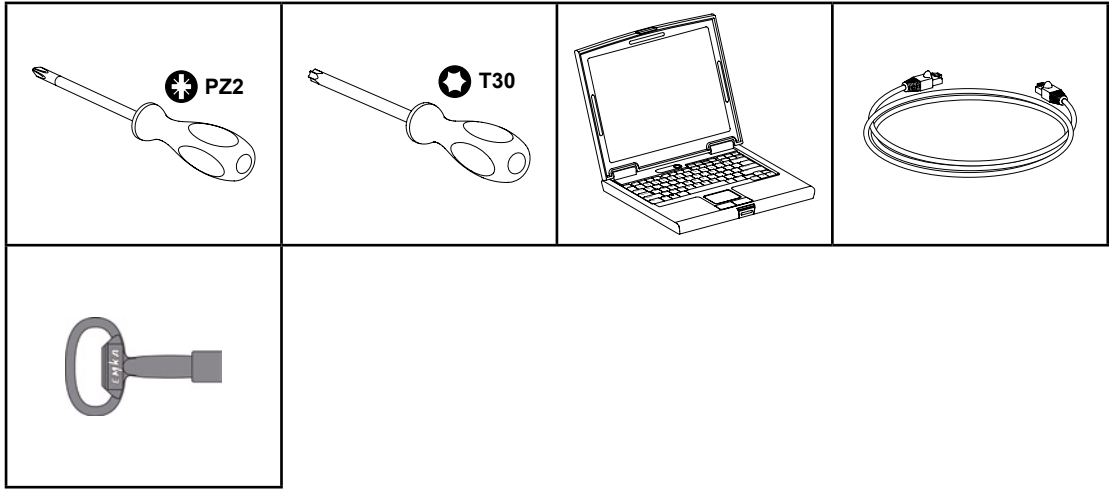

## Tools and accessories required



## Application

This guide is applicable to the Smart Wallbox.

This guide is also applicable to Parking and City stations with a date code equal to or greater than 2014 week 45.

<b>EV●1S22P33</b>		<b>EVlink</b>
<b>HRB14427</b>		
<b>Electric vehicle charging station</b>		<b>22kW</b>
<b>Left socket-in/out:</b> IEC 62196 type 3c 400V 3~ 32A 50-60Hz	<b>Right socket-in/out:</b> IEC 62196 type 3c 400V 3~ 32A 50-60Hz	
<b>IP54</b>	<b>IEC 61851-1</b>	<b>IEC 61851-22</b>
<b>ID: 501077B</b> <b>Control input:</b> U: 220V~ I: 0.2A F: 50-60Hz	<b>Made in France</b> Serial: 3N <span style="border: 1px solid black; padding: 2px;">14451</span> 08 001 002   <b>Schneider Electric</b>	

If your charging station has a date code less than 14451, contact Schneider Electric Customer Care Center to update the charging station software.

For City EVC, the serial number must be equal to or later than 4514●●●●●● where 45 corresponds to the week and 14 to the year.

# Product Family

## EVlink Smart Wallbox

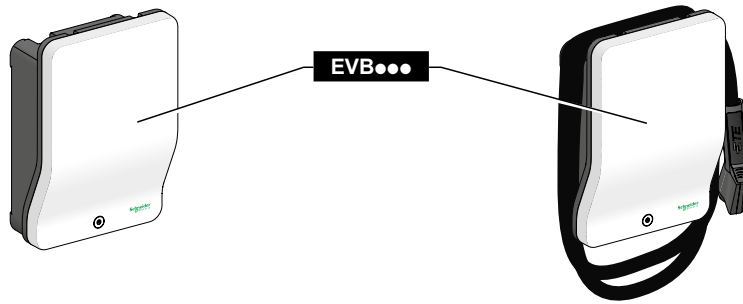

## EVlink Parking

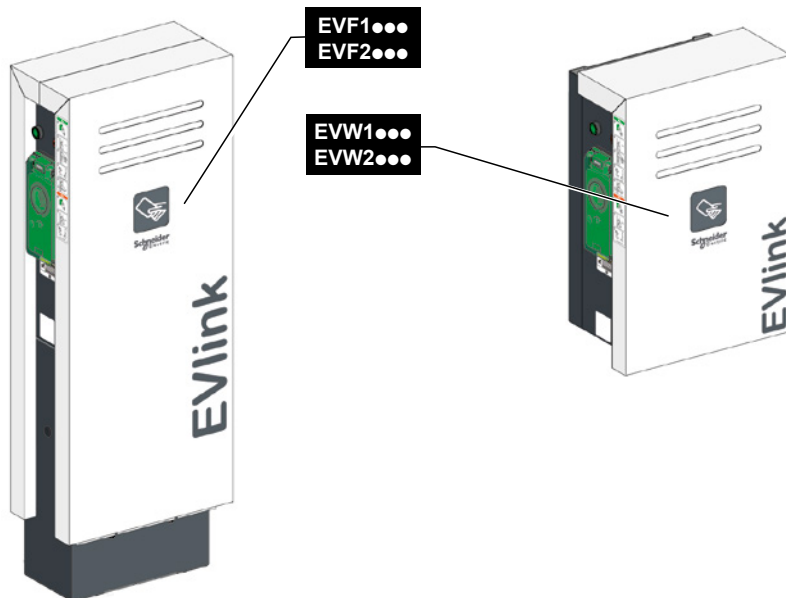

## EVlink City



# Chapter 1

## First level troubleshooting with indicator lights and buttons - Without PC

### 1.1 Description

#### EVlink Smart Wallbox

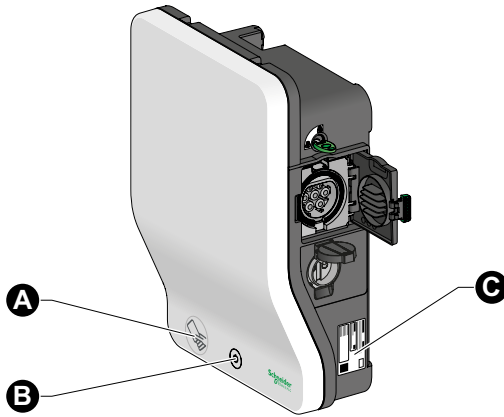

- Ⓐ RFID reader (according to model)
- Ⓑ Stop/Restart button and status indicator light
- Ⓒ Product label

#### EVlink Parking

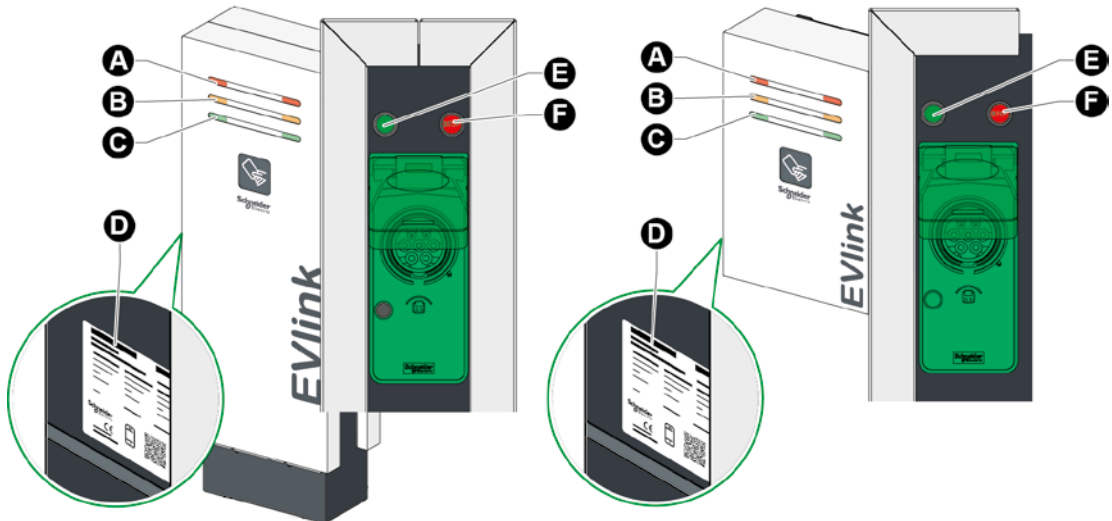

- Ⓐ Socket-outlet not functioning indicator light (red)
- Ⓑ Socket-outlet reserved indicator light (orange)
- Ⓒ Socket-outlet available indicator light (green)
- Ⓓ Product label
- Ⓔ Luminous green push-button Start and Unlock
- Ⓕ Charge stop button



## EVlink City

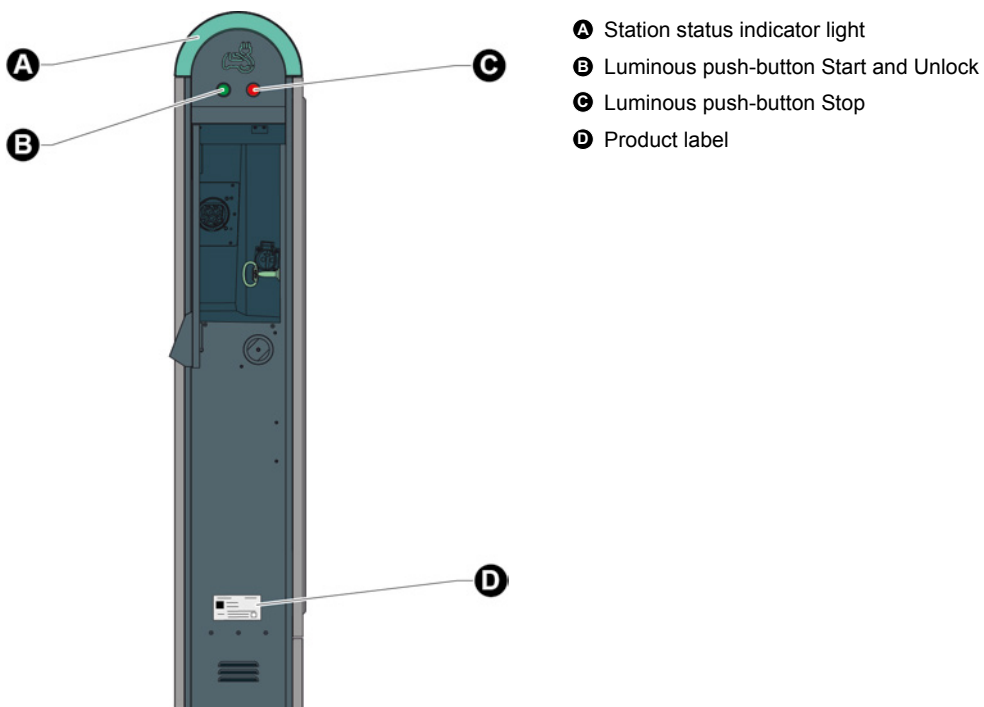

## 1.2 Charging station troubleshooting mode

**IMPORTANT NOTE:**  
 Before starting the troubleshooting phase, check the status of the protective devices (circuit breakers, differential switches, etc.) on your equipment.

To access the charging station troubleshooting mode, the status indicator light of the socket concerned must first be permanently red.

## EVlink Smart Wallbox

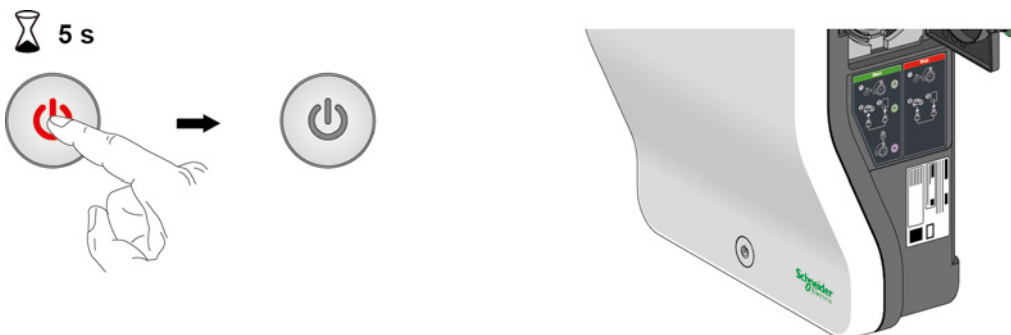

## EVlink Parking

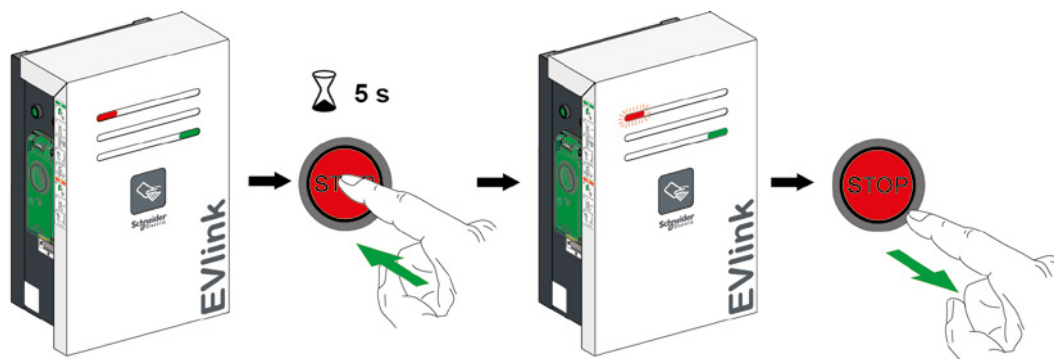

Note: Press the stop button on the fault side.

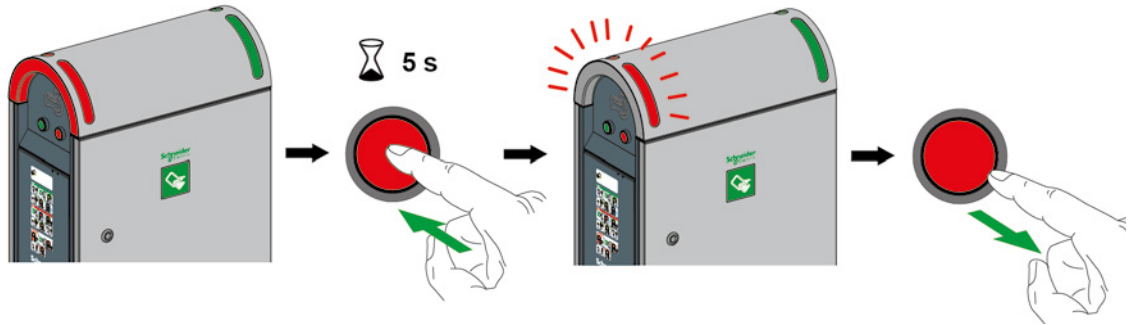

Note: Press the stop button on the fault side.

### 1.3 Reading fault codes

In troubleshooting mode, the charging station launches a sequence of blinkings:

- of the indicator light on the front panel of the Smart Wallbox;
- of the red indicator light on the front panel on the fault side for Parking and City.

The number of blinkings indicates a specific fault code; see the table on page 11 for more details on possible malfunctions.

A sequence may have several fault codes. A pause between each sequence of blinkings on the push-button indicates the beginning or end of a sequence. The fault codes are in chronological order.

If two station sockets are faulty, the operation must be repeated on both sides (Parking and City).

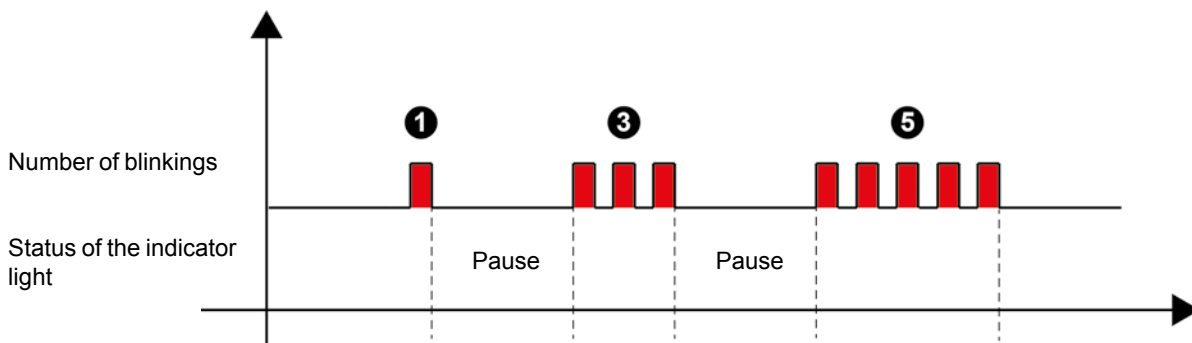

## 1.4 First level troubleshooting

Number of blinkings	Description	Parking	City	Smart Wallbox	What to do
1	Surge arrester fault (Faulty cartridge, badly inserted, "Status" connector unplugged or broken wire)	X	X		Contact Schneider Electric Customer Care Center after first noting the commercial reference and serial number on the product label.
2	Non-locked socket fault => discordance between socket/trap lock sensor status	X	X	X	Check the general status of your connector and socket. Check whether the socket locking hatch is damaged. Remove any foreign bodies that may be in the socket. Try again to insert the connector completely.
2	Trap not locked fault => Discordance in the trap inductive sensor	X	X		Check the general status of the trap. Remove any foreign bodies that may be in the trap closure area. Try again to close your trap by pressing on it firmly.
3	Impossible to connect the master board	X	X		Contact Schneider Electric Customer Care Center after first noting the commercial reference and serial number on the product label.
3	Capacity charge level too low for the functioning of socket locking/unlocking			X	
4	Contactors status wrong (discordance fault)	X	X	X	Contact Schneider Electric Customer Care Center after first noting the commercial reference and serial number on the product label.
4	Return of the status Input 1 wrong (Socket breaker T2/ T3 or Diff. sw. or Domestic socket breaker)	X	X	X	
5	Loss of communication with the cluster manager	X	X	X	Contact Schneider Electric Customer Care Center after first noting the commercial reference and serial number on the product label.
5	No communication with the modem, RSSI less than 10 (with modem =s= configuration by default)	X	X	X	
5	Supervision fault = communication problem with "Supervision" (OCPP) or rights	X	X	X	
5	Loss of communication with the NTP server	X	X	X	
6	Loss of communication with the RFID reader (RFID reader disconnected or faulty)	X	X	X	Contact Schneider Electric Customer Care Center after first noting the commercial reference and serial number on the product label.

Number of blinkings	Description	Parking	City	Smart Wallbox	What to do
6	Loss of communication with the "IEM3xxx" energy meter	X	X	X	Contact Schneider Electric Customer Care Center after first noting the commercial reference and serial number on the product label.
7	Number of charge phases wrong => if single-phase charging station used as three-phase	X	X		Contact Schneider Electric Customer Care Center after first noting the commercial reference and serial number on the product label.
7	Over-current charging fault	X	X	X	Try with another vehicle.
8	Loss of communication with the RFID reader or other (third party)	X	X	X	Contacter le support clients de Schneider Electric après avoir relevé la référence commerciale et le numéro de série sur l'étiquette du produit.
8	Socket or electric vehicle not connected after one minute or for the City = Domestic and T2/T3 connected on the same side	X	X	X	Check the general status of your cables and your station and car side sockets. Remove any foreign bodies that may be in the interconnections. Try again to fully insert the connectors. Try with another cable.
8	Communication fault with a Mode 3 vehicle ("CP" error: Pilot control)	X	X	X	Try with another cable; if this still does not work, try with another vehicle or simulator.
8	Cable status wrong (the value of the coding resistor "PP" is wrong)	X	X	X	
8	Charging fault on short-circuit Pilot wire (CP)	X	X	X	
8	Charging fault following disconnection of the cable of the electric vehicle.	X	X	X	Try with another cable; if this still does not work, try with another vehicle or simulator and do not disconnect the cable while charging. Interrupt charging on the vehicle side by requesting cable disconnection and then on the station side.
9	Anti-intrusion fault on the charging station (Door open or faulty door contact)	X	X		Contact Schneider Electric Customer Care Center after first noting the commercial reference and serial number on the product label.
10	Configuration file missing, damaged or already open	X	X	X	Contact Schneider Electric Customer Care Center after first noting the commercial reference and serial number on the product label.

# Chapter 2

## Second level troubleshooting with a PC

### 2.1 Connection to the charging station

**IMPORTANT NOTE:**

Before starting the troubleshooting phase, check the status of the protective devices (breakers, differential switches, etc.) and that power is supplied to your equipment.

#### EVlink Smart Wallbox

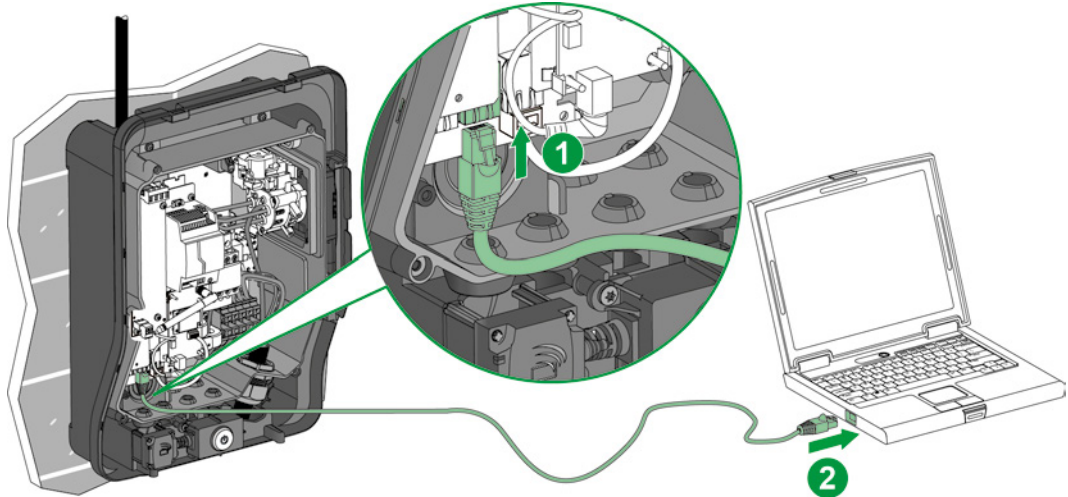

#### EVlink Parking

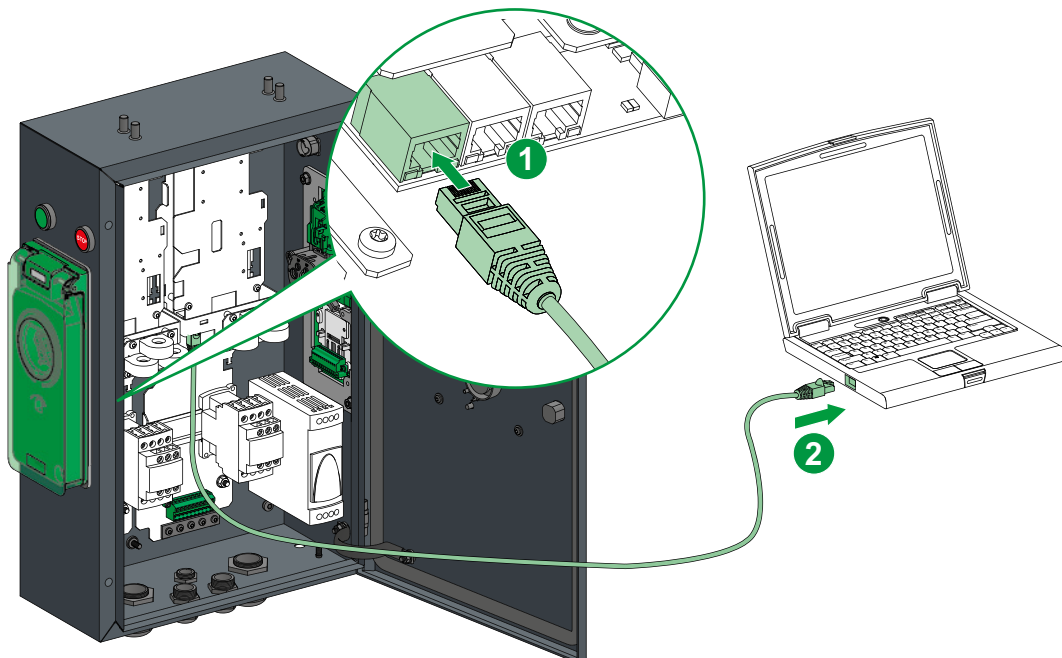

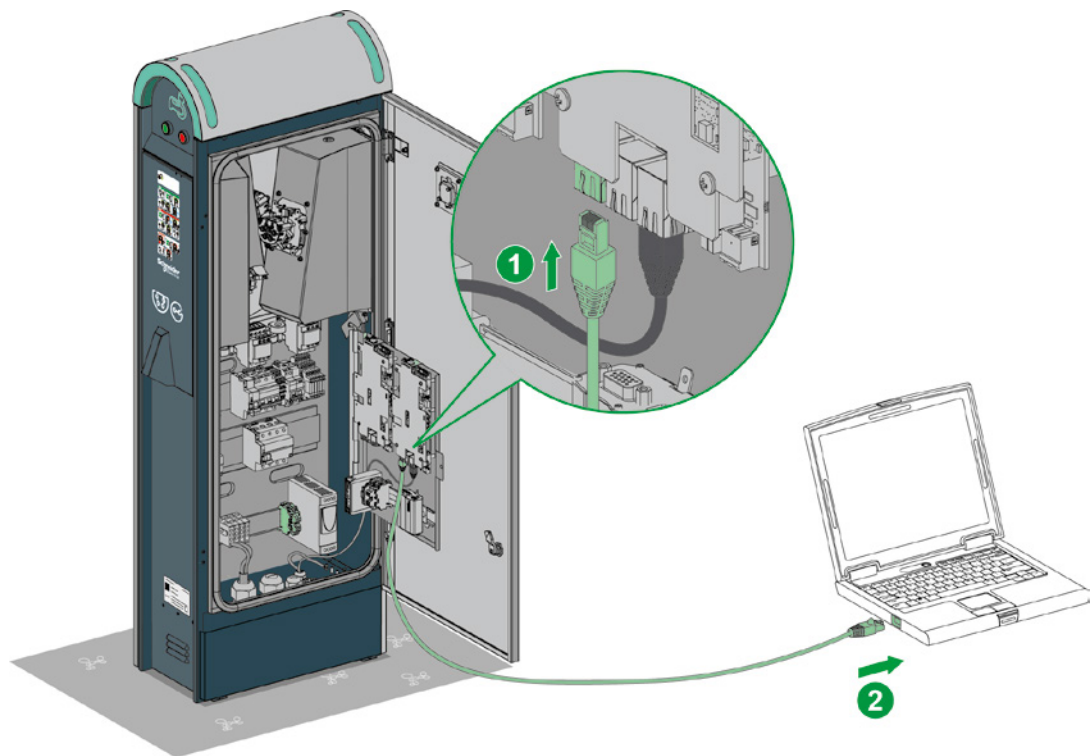

## 2.2 Computer configuration

Step	Action
1	Check that your PC is connected by Ethernet cable to the charging station and that the latter is powered up.
2	Open the network properties menu on your PC.
3	Click "Connect to local network".
4	Click "Properties".
5	Open the properties of the Internet version 4 protocol (TCP/IP v4).
6	Set the static IP address properties as follows (note the settings before modifying so as to be able to return afterwards to the initial configuration): <ul style="list-style-type: none"> <li>■ IP address: 192.168.0.x (where x is a number between 241 and 249)</li> <li>■ Subnet mask: 255.255.255.0</li> <li>■ No default gateway</li> <li>■ No DNS server</li> <li>■ No proxy</li> </ul>

## 2.3 Downloading the report

Open your Internet browser and enter `http://192.168.0.102` in the URL address bar. IP valid ex-factory. If the IP of the station has changed meanwhile, configure your network settings accordingly and enter the new address in your browser.

Choose the language and enter the login details:

- User: admin
- Password: ADMIN

Go to the "Maintenance" tab.

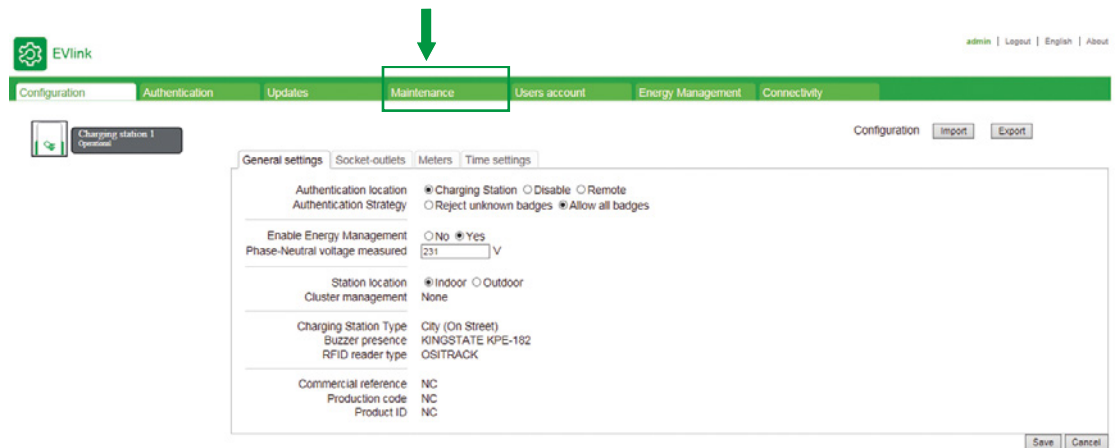

Click "Export" in the "Status" field in the "Maintenance" tab.

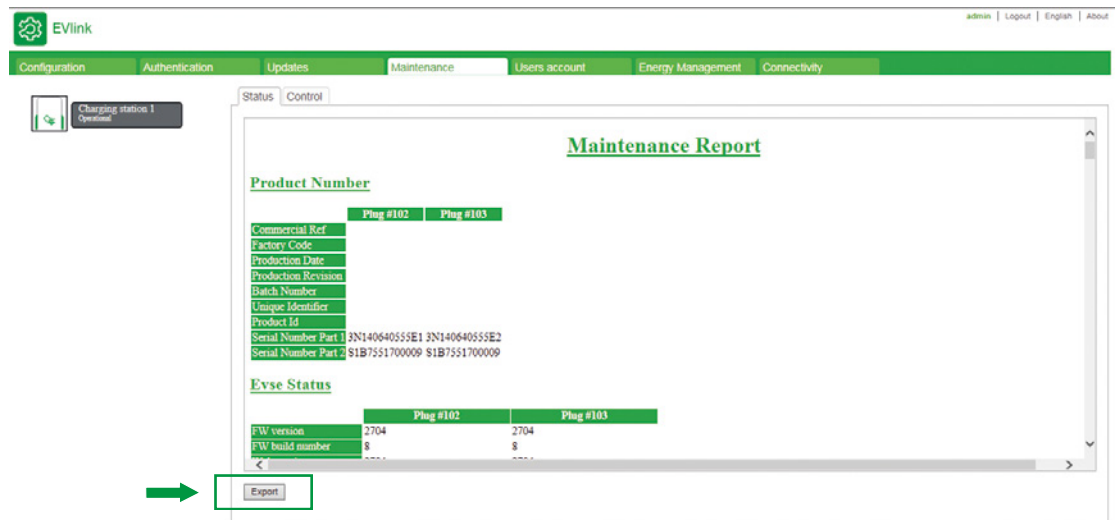

Save the report on your PC.

The exported file is in HTML format and is opened with an Internet browser.

## 2.4 Description of the report

The red frames in each part of the report indicate important information for the Customer Care Center.

### Product reference

Product number

	Plug #102	Plug #103
Commercial Ref	EV.1S22P33R	EV.1S22P33R
Factory Code	3N	3N
Production Date	14122	14122
Production Revision	09	09
Batch Number	003	003
Unique Identifier	003	003
Product Id	50097F3	50097F3
Serial Number Part 1	3N135130433A2	3N135130434H1
Serial Number Part 2	S1B7551700007	S1B7551700007

### Software versions

EVSE Status

	Plug #102	Plug #103
FW version	2703	2703
FW build number	17	17
Web version	2703	2703
Websvr build number	17	17
Boot Counter	6	6
CPW state	EVSE_Available_StateA	EVSE_Available_StateA
Cable state	Not_Plugged	Not_Plugged
EV state	A_Not_Present_12V	A_Not_Present_12V
Last charge status	255	255
Evse Status	NormalMode3	NormalMode3
Outlet Status	NotInitialized	NotInitialized
Outlet Status Last Error	NotInitialized	NotInitialized
Selected Charge Power	NOTHING	NOTHING
Selected Charge Duration	Undefined	Undefined
[ErrorStatusWord_Level2]	0x0000	0x0000
[ErrorStatusWord_Level1]	0x0040	0x0040

### Bit status

Error status (KO = default).

bit description	Plug #102	Plug #103
bit0 - Rfid Status	OK	OK
bit1 - Stu Status	OK	OK
bit2 - Connection Master Slave	OK	OK
bit3 - DI PlugLock	OK	OK
bit4 - ContactorState	OK	OK
bit5 - DI Parafoudre	OK	OK
bit6 - DI Anti- intrusion	KO	KO
bit7 - DI US DB not found	OK	OK
bit8 - ConfigurationFileError	OK	OK
bit9 - DI ShutterUnlock	OK	OK
bit10 - DI CB FLSI	OK	OK
bit11 - DI PowerMeter Comm	OK	OK
bit12 - RemoteControllerLost	OK	OK
bit13 - Socket State Error	OK	OK
bit14 - Nb Phase Incorrect	OK	OK
bit15 - Plc Connection Lost	OK	OK
bit16 - ChargeError CommunicatonError	OK	OK
bit17 - ChargeError CableDisconnected	OK	OK
bit18 - ChargeError EV Disconnected	OK	OK
bit19 - ChargeError ShortCut	OK	OK
bit20 - ChargeError OverLoad	OK	OK
bit23 - Modem Error	OK	OK
bit29 - SupervisionError	OK	OK
bit30 - NTP Server CommunicationError	OK	OK



## List of latest errors

Correspondence of the "Latest errors" with the malfunction "bits" described in the **Error Status** table:

- Error 0 = bit1
- Error 1 = bit2
- ...

### Latest errors

Start Date	End Date	Plug	Error Code
-	-	-	-

## Additional information

The remaining information is for Schneider Electric.

### Hardware Reference

	Plug #102	Plug #103
enveloppe	Monoblock	Monoblock
outletNumber	Socket-outlet 2	Socket-outlet 2
plugType	T3	T3
boardType	MP2	MP2
isAttachedCable	False	False
pushButton	Normal and stop	Normal and stop
lockType	Double lock	Double lock
lightIndicators	AVAILABILITY_AND_BOOKED_AND_OUT_OF_ORDER	AVAILABILITY_AND_BOOKED_AND_OUT_OF_ORDER
chargeIndicators	Load lamp only	Load lamp only
buzzer	KINGSTATE KPE-182	KINGSTATE KPE-182
modem	None	None
display	None	None
rfidReader	OSITRACK	OSITRACK

### Io Model

	Plug #102	Plug #103
IoModel	255	255

### Network

	Plug #102	Plug #103
Physical Address	00 - 80 - f4 - 42 - 10 - bf	00 - 80 - f4 - 42 - 10 - 70
Ip Address	0.0.0.0	0.0.0.0
Sub-Network Mask	255.255.255.0	255.255.255.0
Default Gateway	192.168.0.254	192.168.0.254
Preferred DNS Server	0.0.0.0	0.0.0.0

## 2.5 Second level troubleshooting

Erroneous bit	Description	Parking	City	Smart Wallbox	What to do
bit0 - Rfid Status	Loss of communication with the RFID reader (RFID reader disconnected or faulty)	X	X	X	Check the wiring of the RFID badge reader, the status of the LEDs on it and the software version in the update tab of the Internet server of the charging station. Try to update the software version of the badge reader with the latest update available on the Schneider Electric sites. Re-boot the charging station.
bit2 - Connection Master Slave	Impossible to connect the master board	X	X		Check the Ethernet cable between the two boards. Try replacing or changing the connector on the boards. Check the communication by the LEDs on the RJ45 (orange/green/blinking or not). Also check to the right of the 3 RJ45 connectors the status of the board LEDs (green/red/blinking or not). Re-boot the tcharging station. If there is still the fault on re-booting, perform a back to factory on the left then on the right. See chapter 3.1.
bit3 - DI PlugLock	Non-locked socket fault => discordance between socket/trap lock sensor status	X	X	X	Check the general status of your connector and socket. Check whether the socket locking hatch is damaged or missing. Remove any foreign bodies that may be in the socket or the cable. Try again to insert the connector completely.
bit4 - ContactorState	Contactor status wrong (discordance fault)	X	X	X	Check that the contactor is not stuck and the wiring of auxiliary contacts. If the contactor is stuck, have your vehicle checked at the dealer's; there may be a short-circuit in the on-board charger. Change the contactor.
bit5 - DI Parafoudre	Surge arrester fault (Faulty cartridge, badly inserted, "Status" connector unplugged or broken wire)	X	X		If you do not have surge arrestors in your configuration, check the shunt. If you have surge arrestors, check the status of the cartridges and that they are well inserted. In all cases, check the connector on the electronic board and on the surge arrester. The circuit must be completed to allow charging.
bit6 - DI Anti- intrusion	Anti-intrusion fault on the charging station (Door open or faulty door contact)	X	X		The charging station goes to return to factor settings mode if you attempt troubleshooting using the buttons. The green push-button will blink for 5s. Do not press it. Check the door and the door contact, check the change of red => green status of the indicator lights by pressing the door contact. Check that the bracket is not bent, the status of the cables from the door contact at the bottom of the appliance and that the connectors are well inserted on the electronic board.
bit8 - ConfigurationFileError	Configuration file missing, damaged or already open	X	X	X	Go to charging station commissioning tool. Before making any modifications at all to this file, save it. If you have already saved this file, import it. If you have no backup, perform a return to factory settings in the maintenance tab and redo a complete commissioning.
bit9 - DI ShutterUnlock	Trap not locked fault => Discordance in the trap inductive sensor	X	X		Check the general status of the trap. Remove any foreign bodies that may be in the trap closure area. Try again to close your trap by pressing on it firmly. Check the status and position of the inductive sensor.

Erroneous bit	Description	Parking	City	Smart Wallbox	What to do
bit10 - DI CB FLSI	Return of the status Input 1 wrong (City: Socket breaker T2/T3 or Diff. sw. or Domestic socket breaker)	X	X	X	Check the status of your protective devices. Breaker, Mnx, differential switch. Check the wiring of the OF and Mnx. Check the connectors of these functions inside the charging station.
bit11 - DI PowerMeter Communication	Loss of communication with the "IEM3xxx" energy meter	X	X	X	Check the wiring of the energy meter and its power supply. Check that the settings are coherent with those in the commissioning guide.
bit12 - Remote Controller Lost	Loss of communication with the RFID reader or other (third party)	X	X	X	Check the status of the LEDs on your external RFID reader and the connections up to the charging station. Re-boot the 2 systems, the external reader then the station.
bit13 - Socket State Error	Socket or electric vehicle not connected after one minute or for the City = Domestic and T2/T3 connected on the same side	X	X	X	Check the general status of your cable and your station side and car side sockets. Check that your car locks the cable properly. Remove any foreign bodies that may be in the interconnections. Try again to insert the connectors completely.
bit14 - Nombre de phase incorrect	Number of charge phases wrong => if single-phase charging station used as three-phase	X	X		You have a 7kW charger (single-phase) and you have connected 3 phases to it. Try disconnecting phases 2 and 3.
bit15 - Plc Connection Lost	Loss of communication with the cluster manager	X	X	X	OPTION Check the Ethernet cable between the charging station and the PLC. Check the status of the PLC in run mode; any errors on the status LEDs. Reset the PLC cabinet and boxes.
bit16 - ChargeError CommunicatonError	Communication fault with a Mode 3 vehicle ("CP" error: Pilot control)	X	X	X	Try with another cable; if this still does not work, try with another vehicle or simulator.
bit17 - ChargeError CableDisconnected	Cable status wrong (the value of the coding resistor "PP" is wrong)	X	X	X	Try with another cable; if this still does not work, try with another vehicle or simulator.
bit18 - ChargeError EV Disconnected	Charging fault following disconnection of the cable of the electric vehicle	X	X	X	Try with another cable; if this still does not work, try with another vehicle or simulator and do not disconnect the cable while charging. Interrupt charging on the vehicle side by requesting cable disconnection and then on the charging station side.
bit19 - ChargeError ShortCut	Charging fault on short-circuit Pilot wire (CP)	X	X	X	Try with another cable; if this still does not work, try with another vehicle or simulator.
bit20 - ChargeError OverLoad	Over-current charging fault	X	X	X	Try with another vehicle.



Erroneous bit	Description	Parking	City	Smart Wallbox	What to do
bit23 - Modem Error	No communication with the modem, RSSI less than 10 (with modem =s= configuration by default)	X	X	X	OPTION Check the Ethernet cable between the charging station and the modem. Check the modem power supply. Refer to the modem documentation to analyse the status LEDs. Reset the box and the modem. Change the antenna position, check the RSSI (GPRS signal strength) in the modem Internet server. This must be greater than 10.
Bit24 - Energy Reserve Error	Capacity charge level too low for the functioning of socket locking/unlocking			X	Check the connectors of the daughter board (upper board with black capacity above).
bit29 - SupervisionError	Supervision fault = communication problem with "Supervision" (OCPP) or rights	X	X	X	OPTION Check the status of your charging station in the charging station commissioning tool and export the maintenance report. Reset the box and the modem. Change the antenna position, check the RSSI (GPRS signal strength) in the modem commissioning tool. This must be greater than 10. Call the administrator (Supervision) of your charging station to obtain its status. Check the concordance between the charging station and the back-end (box identity charging station registration).
bit30 - NTP Server CommunicationError	Loss of communication with the NTP serve	X	X	X	Try changing your NTP server settings in the commissioning tool of the charging station and check the connection (wire and firewall) to your network.



# Chapter 3

## Returning to factory settings of the charging station

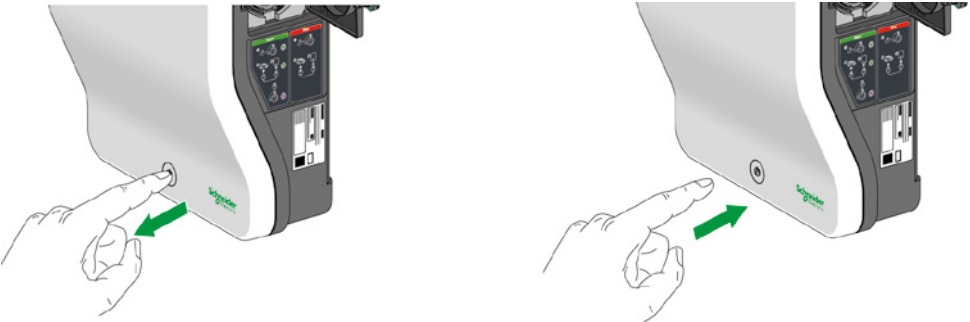
### 3.1 Manually and without PC

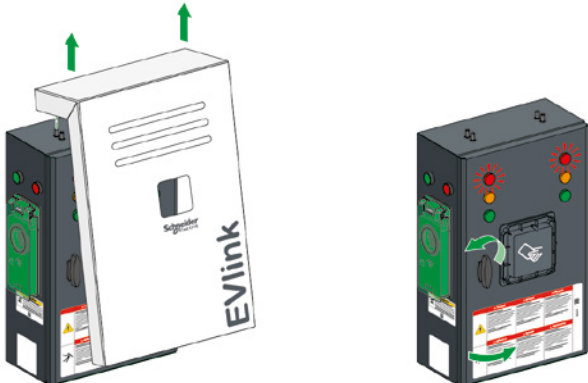
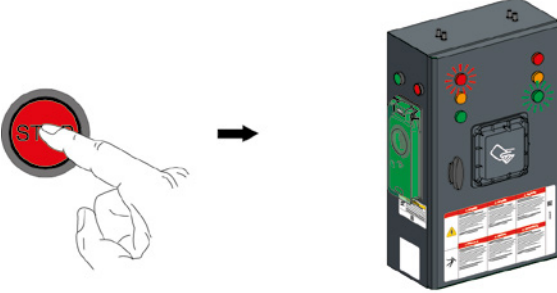

#### EVlink SmartWallbox

Step	Action
1	<p>Keep the indicator light button pressed down when the charging station is powered up until it blinks red.</p> 
2	<p>Release and quickly press the indicator light button again during the 4 red blinkings.</p> 
3	<p>The charging station emits 3 beeps and the red blinking indicator light goes out.</p> 
4	<p>The charging station takes about a minute to start.</p>

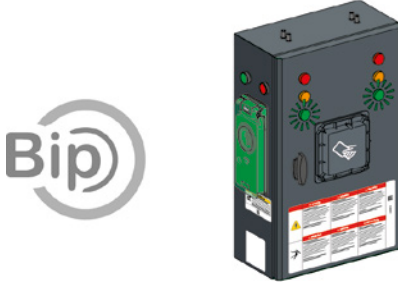
Step	Action
1	<p>Remove the cover. Open the door. The indicator lights are red.</p> 
2	<p>Press the right-hand stop button (about 10s) until the right-hand red indicator light goes out and the right-hand green light blinks. Release.</p> 
3	<p>The green indicator light on the front face blinks. Quickly press the green push-button during these 10 blinkings to launch the return to factory settings.</p> 

Step	Action
4	<p>The charging station emits a long beep and the green indicator lights blink.</p> 
5	<p>Close the door.</p> <p>The charging station takes about a minute to restart.</p>
	<p><b>IMPORTANT NOTE:</b></p> <ul style="list-style-type: none"> <li>■ If at step 3 all the right-hand indicator lights are off, close the door and restart the procedure.</li> <li>■ If at step 4 only the right-hand green indicator light has blinked, also perform this procedure on the left hand side, then the right.</li> </ul>

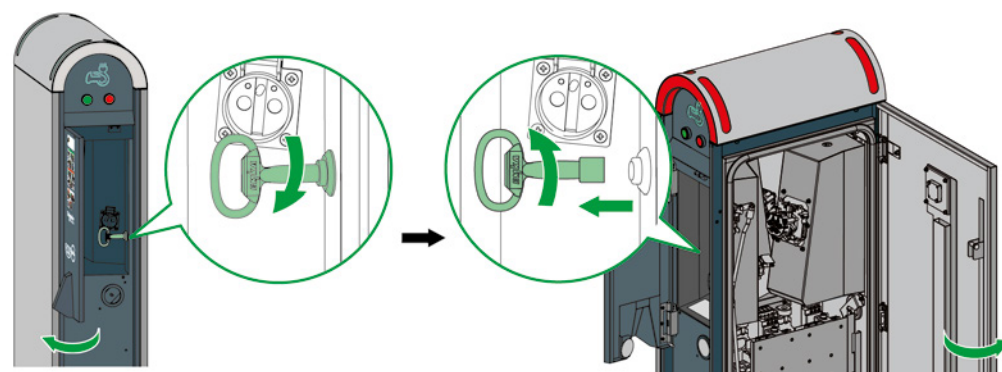
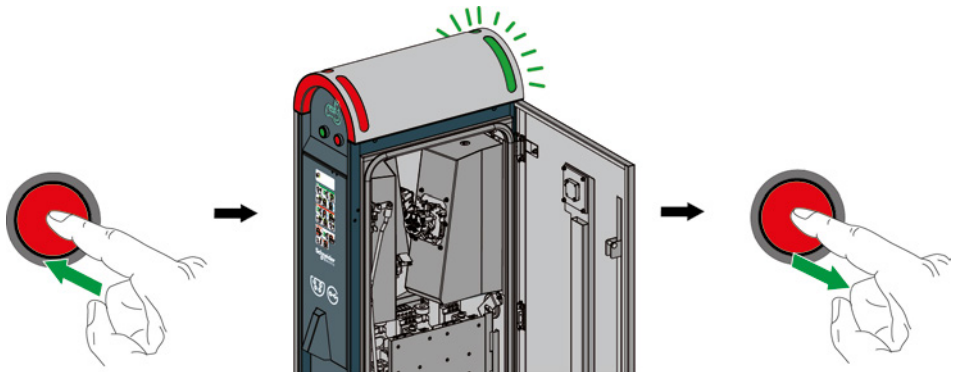
EVlink City - (→ 05 / 2016)

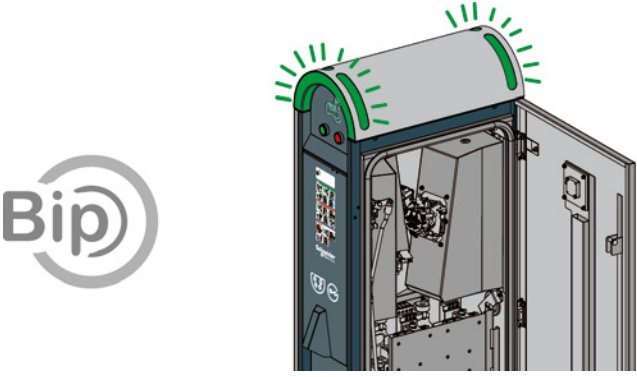

Step	Action
1	<p>Open the door. The indicator lights are red.</p> 
2	<p>Press the right-hand stop button (about 10s) until the right-hand red indicator light goes out and the right-hand green indicator light blinks.</p> <p>Release.</p> 
3	<p>The green indicator light on the front face blinks. Quickly press the green push-button during these 10 blinkings to launch the return to factory settings.</p> 

Step	Action
4	<p>The charging station emits a long beep and the green indicator lights blink.</p> 
5	<p>Close the door.</p> <p>The charging station takes about a minute to restart.</p>
	<p><b>IMPORTANT NOTE:</b></p> <ul style="list-style-type: none"> <li>■ If at step 3 all the right-hand indicator lights are off, close the door and restart the procedure.</li> <li>■ If at step 4 only the right-hand green indicator light has blinked, also perform this procedure on the left hand side, then the right.</li> </ul>

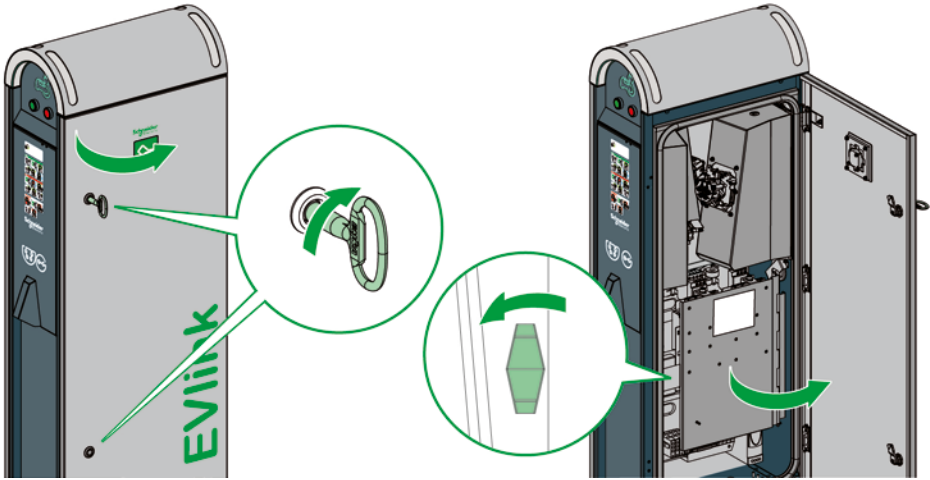
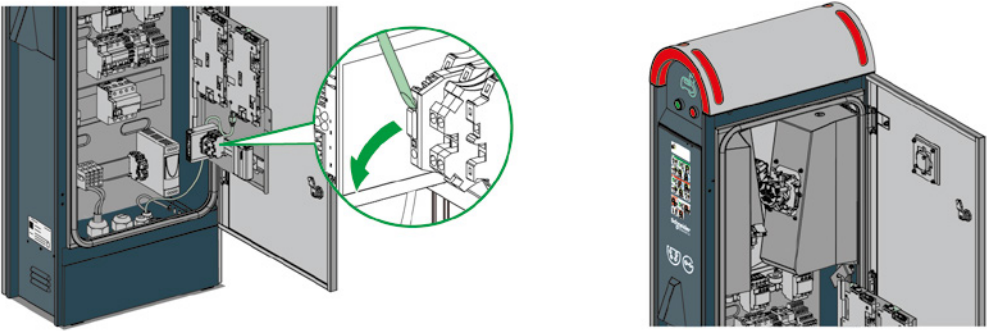
EVlink City - (05 / 2016 →)

Step	Action
1	<p>Open the door then open the trap.</p> 
2	<p>Open the contact. The indicator lights are red.</p> 

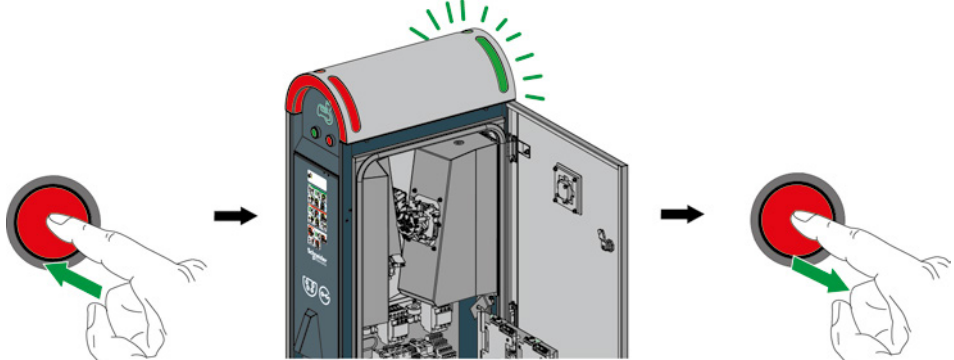

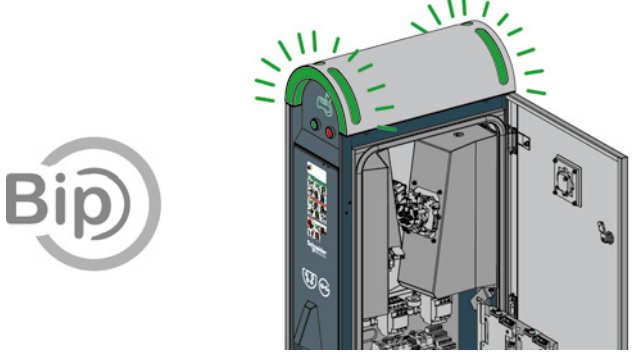
Step	Action
3	<p>Press the right-hand stop button (about 10s) until the right-hand red indicator light goes out and the right-hand green indicator light blinks.</p> <p>Release.</p> 
4	<p>The green indicator light on the front face blinks. Quickly press the green push-button during these 10 blinkings to launch the return to factory settings.</p> 
5	<p>The charging station emits a long beep and the green indicator lights blink.</p> 
6	<p>Close the trap contact.</p> <p>Close the trap and the door.</p> <p>The charging station takes about a minute to start.</p>
	<p><b>IMPORTANT NOTE:</b></p> <ul style="list-style-type: none"> <li>■ If at step 3 all the right-hand indicator lights are off, close the trap contact and restart the procedure.</li> <li>■ If at step 4 only the right-hand green indicator light has blinked, also perform this procedure on the left hand side, then the right.</li> </ul>

### 3.2 With PC

To return to factory settings with a PC and the commissioning tool, refer to the document DOCA0060EN.



35, rue Joseph Monier  
F-92505 Rueil-Malmaison Cedex  
Phone: + 33 (0) 1 41 29 70 00  
Fax: + 33 (0) 1 41 29 71 00  
[www.schneider-electric.com](http://www.schneider-electric.com)

As standards, specifications and designs change from time to time,  
please ask for confirmation of the information given in this publication.

Life Is On | **Schneider**  
Electric