

Schneider Electric Industries SAS
35, rue Joseph Monier
92506 Rueil Malmaison
France

A

B

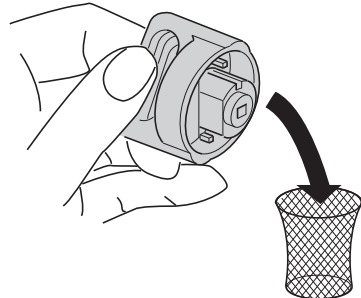
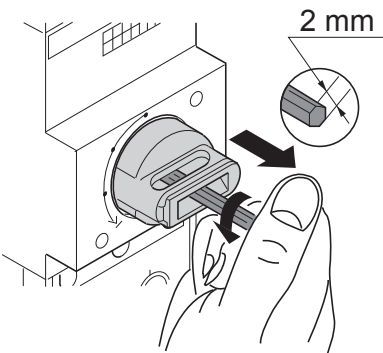
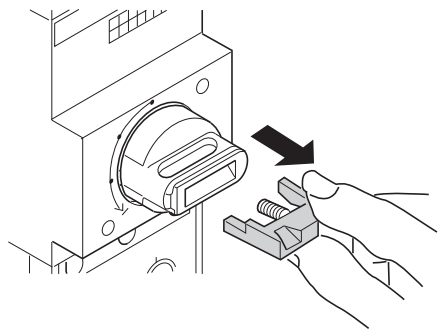
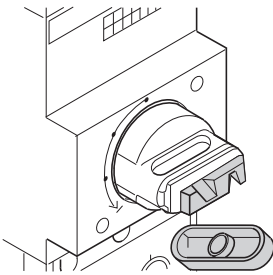
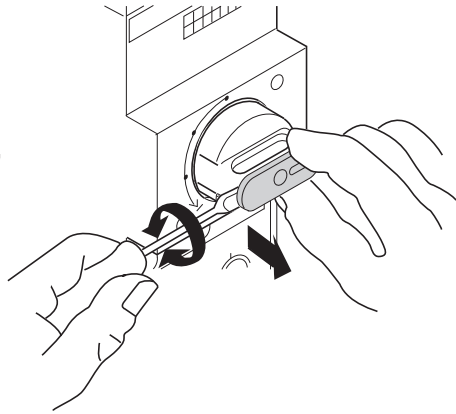
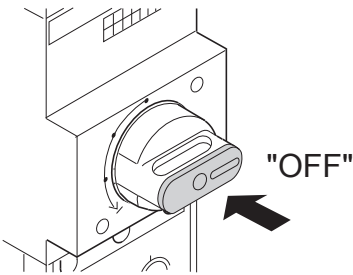

A

LA9-LC 32● (LD1)
LA9-LC 52● (LD4-LD5)

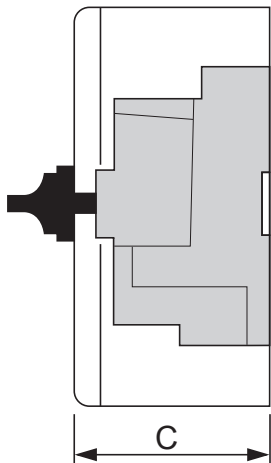

I 32 C = 135 mm
I 63 C = 172 mm

B

LA9-LC 33● (LD1)
LA9-LC 53● (LD4-LD5)

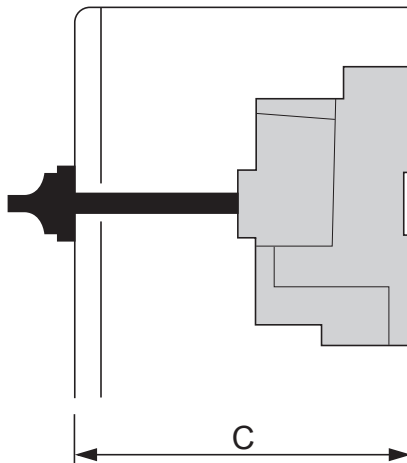

I 32 170 ≤ C ≤ 320 mm
I 63 207 ≤ C ≤ 357 mm

A

B

" off "

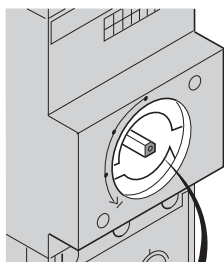

LD1

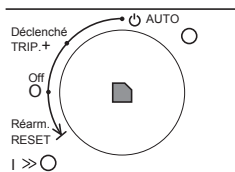

LD4-LD5

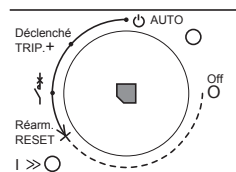

A

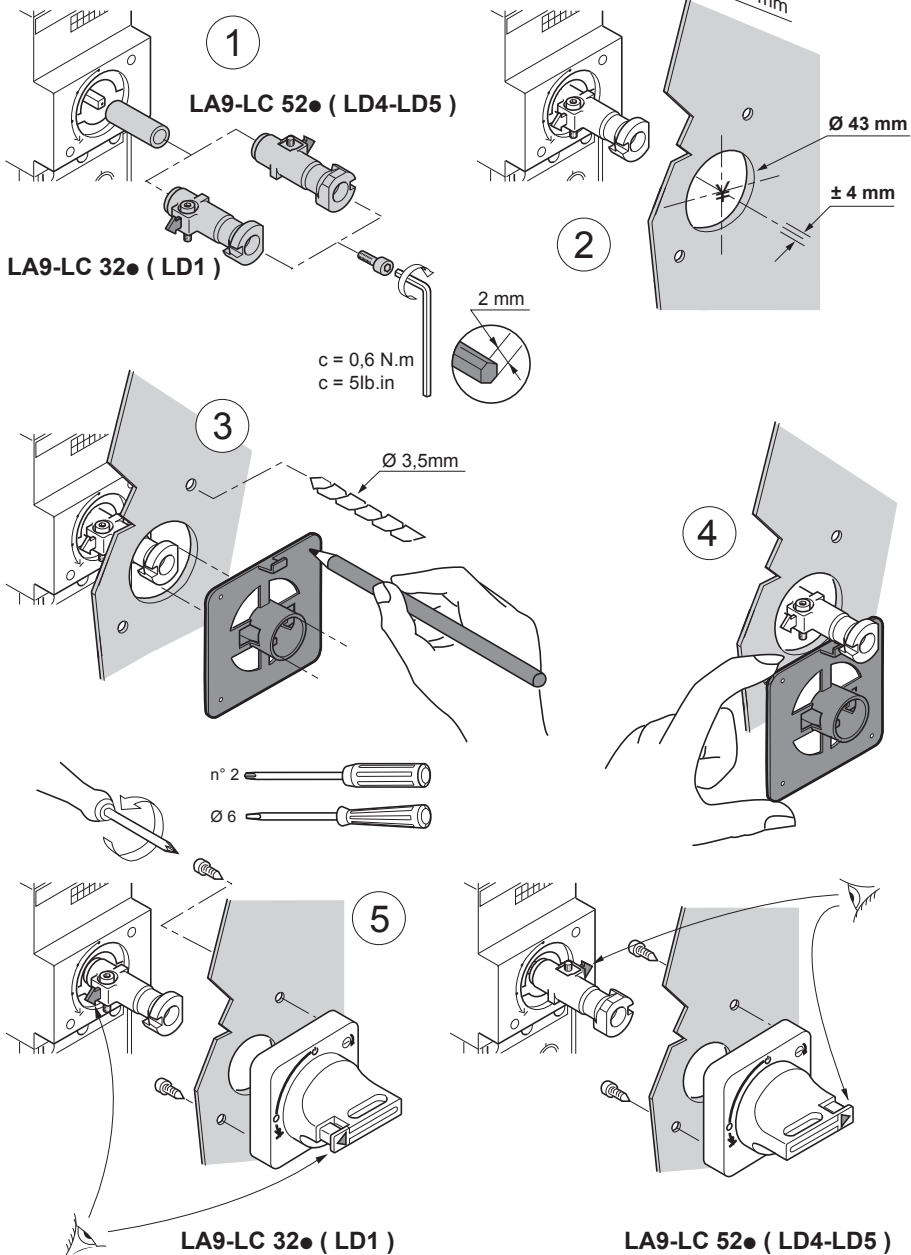

B

LD1

LD4-LD5

1

2

3

4

5

6

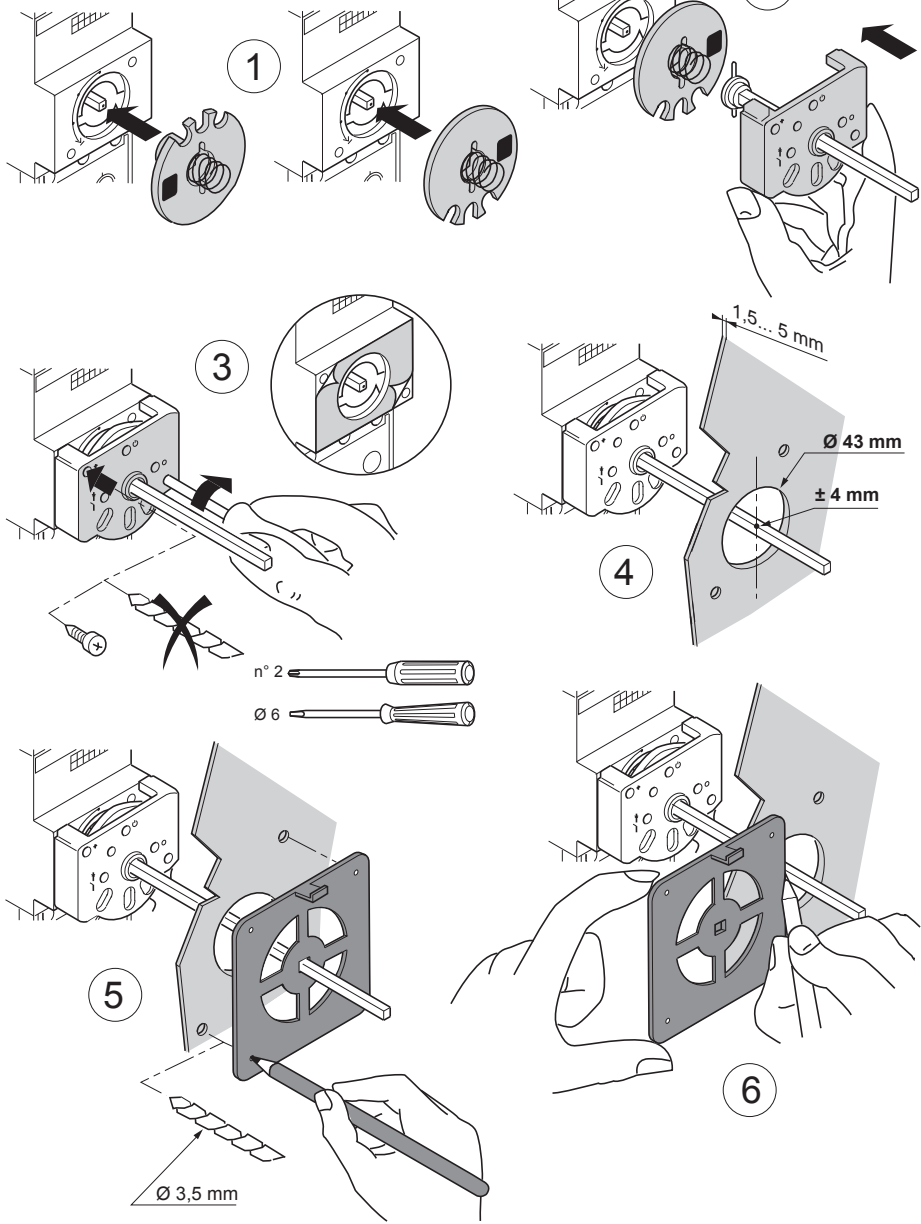

B

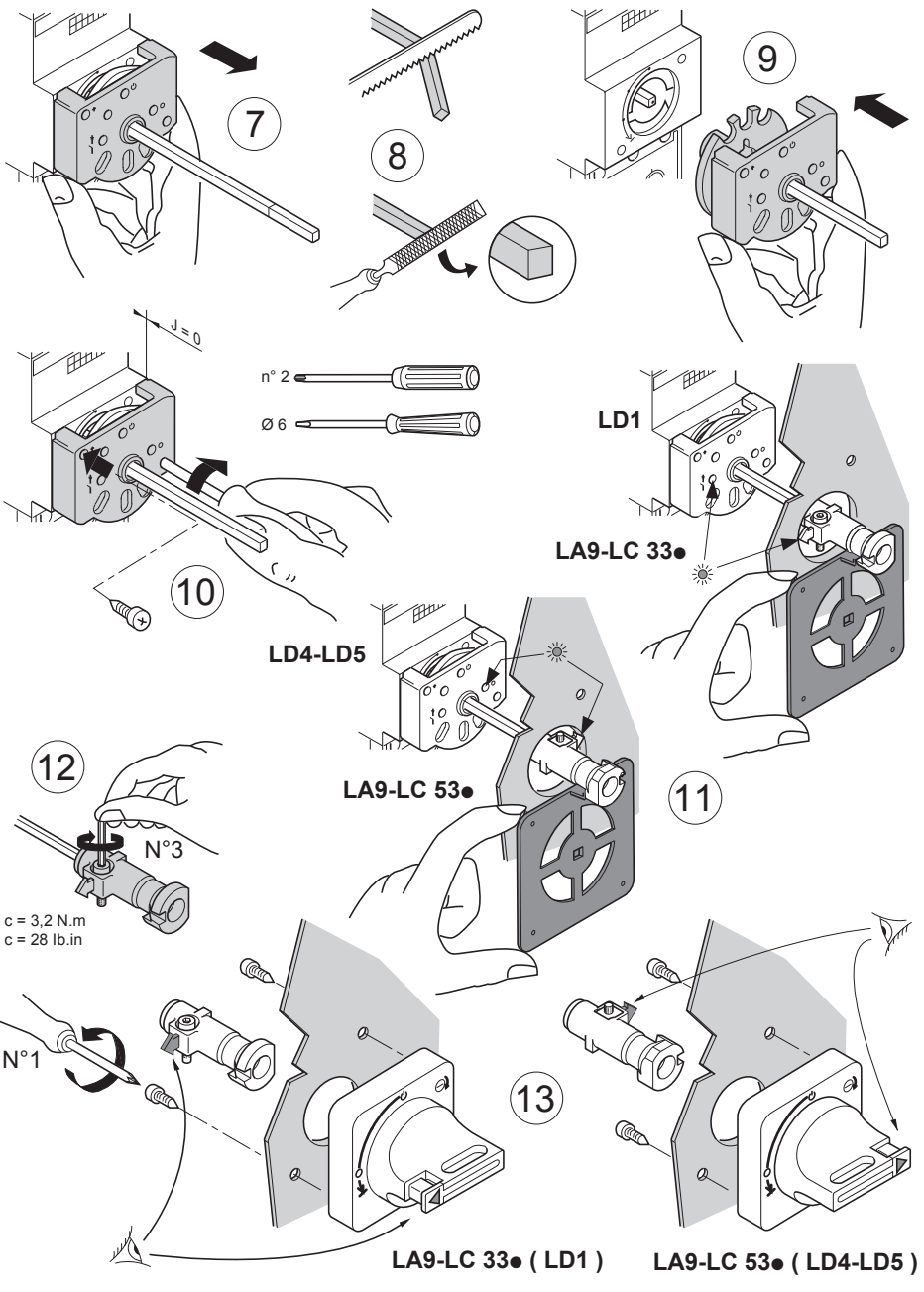

A

LD1

" off "

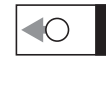
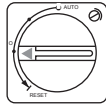
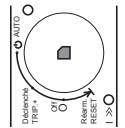
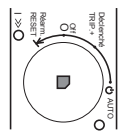
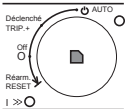

LD4-LD5

" off "

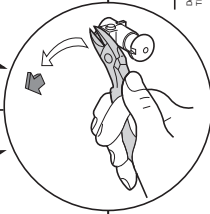
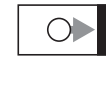
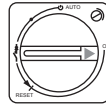
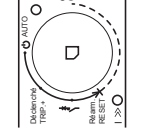
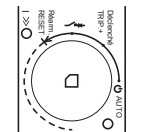
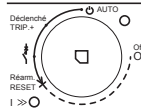

B

LD1

" off "

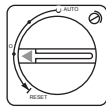

LD4-LD5

" off "

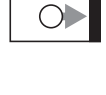
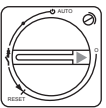

(A)

LD1

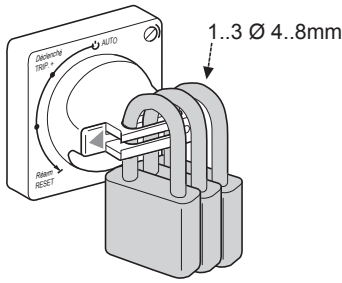

(B)

LD4-LD5

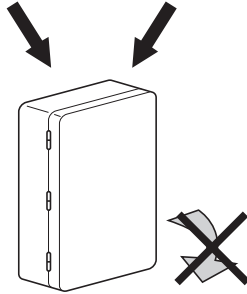
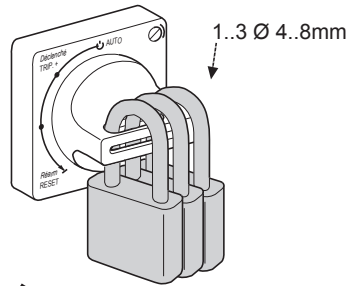

(A)

(B)

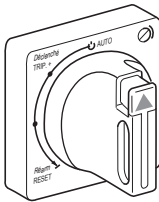

AUTO

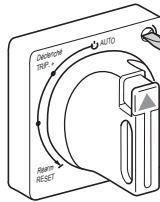

AUTO

