

# RTC48 Temperature Controller Quick Start Guide

03/2013

## Important Information

Read these instructions carefully and look at the equipment to become familiar with the device before trying to install, operate, or maintain it. The following special messages may appear throughout this documentation or on the equipment to warn of potential hazards or to call attention to information that clarifies or simplifies a procedure.

**⚠ DANGER**  
**DANGER** indicates an imminently hazardous situation which, if not avoided, **will result in death** or serious injury.

**⚠ WARNING**  
**WARNING** indicates a potentially hazardous situation which, if not avoided, **can result in death** or serious injury.

**⚠ CAUTION**  
**CAUTION** indicates a potentially hazardous situation which, if not avoided, **can result in minor or moderate injury** and equipment damage.

## 1. Controller References and Characteristics

The following table shows the controller references with the characteristics of each:

| Part Number   | Power Supply  | Input           | Output 1  | Output 2        | Modbus | Alarm = 1 (for Alarm 1) = 2 (for Alarm 1 + 2) |       |   |
|---------------|---------------|-----------------|-----------|-----------------|--------|---|-------|---|
| RTC48PUN1RNHU | 110...240 Vac | Universal input | Relay     | -               | -      | 1   |       |   |
| RTC48PUN1SNHU |               |                 | SSR       | -               | -      | 1   |       |   |
| RTC48PUNCRNHU |               |                 | Relay     | -               | RS485  | 1   |       |   |
| RTC48PUNCSNHU |               |                 | SSR       | -               | RS485  | 1   |       |   |
| RTC48PUN1RRHU |               |                 | Relay     | Relay           | -      | 1   |       |   |
| RTC48PUN1SRHU |               |                 | SSR       | Relay           | -      | 1   |       |   |
| RTC48PUN2RNHU |               |                 | Relay     | -               | -      | 2   |       |   |
| RTC48PUN2SNHU |               |                 | SSR       | -               | -      | 2   |       |   |
| RTC48PUNCRRHU |               |                 | Relay     | Relay           | RS485  | 1   |       |   |
| RTC48PUNCSRHU |               |                 | SSR       | Relay           | RS485  | 1   |       |   |
| RTC48PUN1RSHU |               |                 | Relay     | SSR             | -      | 1   |       |   |
| RTC48PUN1SSHU |               |                 | SSR       | SSR             | -      | 1   |       |   |
| RTC48PUNCRSHU |               |                 | Relay     | SSR             | RS485  | 1   |       |   |
| RTC48PUNCSSHU |               |                 | SSR       | SSR             | RS485  | 1   |       |   |
| RTC48PUN1RNLU |               |                 | 24V ac/dc | Universal input | Relay  | -   | -     | 1 |
| RTC48PUN1SNLU |               |                 |           |                 | SSR    | -   | -     | 1 |
| RTC48PUNCRNLU |               |                 |           |                 | Relay  | -   | RS485 | 1 |
| RTC48PUNCSNLU |               |                 |           |                 | SSR    | -   | RS485 | 1 |
| RTC48PUN1RRLU | Relay         | Relay           |           |                 | -      | 1   |       |   |
| RTC48PUN1SRLU | SSR           | Relay           |           |                 | -      | 1   |       |   |
| RTC48PUN2RNLU | Relay         | -               |           |                 | -      | 2   |       |   |
| RTC48PUN2SNLU | SSR           | -               |           |                 | -      | 2   |       |   |
| RTC48PUNCRRLU | Relay         | Relay           |           |                 | RS485  | 1   |       |   |

| Part Number   | Power Supply | Input | Output 1 | Output 2 | Modbus | Alarm = 1 (for Alarm 1) = 2 (for Alarm 1 + 2) |
|---------------|--------------|-------|----------|----------|--------|---|
| RTC48PUNCSRLU | 24V ac/dc    |       | SSR      | Relay    | RS485  | 1   |
| RTC48PUN1RSLU |              |       | Relay    | SSR      | -      | 1   |
| RTC48PUN1SSLU |              |       | SSR      | SSR      | -      | 1   |
| RTC48PUNCRSLU |              |       | Relay    | SSR      | RS485  | 1   |
| RTC48PUNCSSLU |              |       | SSR      | SSR      | RS485  | 1   |
| RTC48PUNCRRHU |              |       | Relay    | Relay    | RS485  | 1   |

### Accessories included

: Quick Start Guide 1 copy, Mounting frame 1 piece, Gasket (Front mounted to the RTC48) 1 piece, and 50 Ω Shunt resistor (DC current input)

### Accessories sold separately

: Terminal cover x 2 pieces (RTCCOV), Communication cable (RTCCBL), and Spare parts (RTCACC)

## 2. Display of RTC48

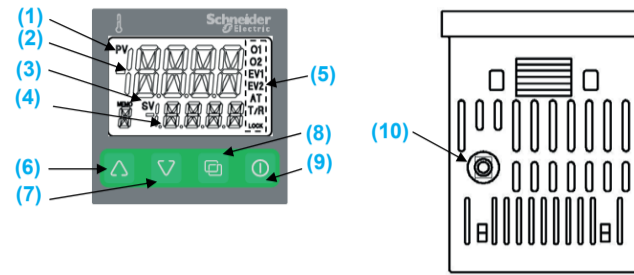

| Item | Name              | Function  |
|------|-------------------|---|
| 1    | PV indicator      | Lights when Process Values (PV) are indicated in the PV/SV display mode.  |
| 2    | PV display        | Indicates the PV or displays the name of the parameters during the setting mode.  |
| 3    | SV indicator      | Lights when Setting value (SV) are indicated in the PV/SV display mode.   |
| 4    | SV display        | Indicates the SV, Manipulated Variable (MV), or each set value during the setting mode.   |
| 5    | Action indicators | O1 (OUT1): Lights when control output (OUT1) is ON.   |
|      |                   | O2 (OUT2): Lights when control output (OUT2) (when OUT2 model applicable) is ON.  |
|      |                   | EV1: Lights when Alarm 1 output is ON.  |
|      |                   | EV2: Lights when Alarm 2 output is ON (when Alarm 2 model is applicable).   |
|      |                   | AT: Flashes while AT (auto-tuning) or auto-reset is performing.   |
|      |                   | T/R: Lights during serial communication (when communication model is applicable).   |
| 6    | Increase key      | Increases the numeric value.  |
| 7    | Decrease key      | Decreases the numeric value.  |
| 8    | Page key          | Selects the setting mode, or registers the setting value. To register the SV, press this key.   |
| 9    | OUT/OFF key       | Switches control output ON/OFF or Auto/Manual control.  |
| 10   | Console connector | By connecting to the USB communication cable (RTCCBL, sold separately), you can conduct the following operations from the external computer using the loader software Zello Temperature Control Soft:<br><ul style="list-style-type: none"> <li>• Reading and setting of SV, PID, various set values</li> <li>• Reading of PV and action status</li> <li>• Function change</li> <li>• Monitoring the trend of PV, SV, and MV</li> </ul> |

## 3. Main Specifications

| Name                              | Description   |
|-----------------------------------|---|
| Supply voltage                    | 100...240 Vac 50/60 Hz, 24V ac/dc 50/60 Hz  |
| Allowable voltage fluctuation     | 100...240 Vac: 85...264 Vac, 24V ac/dc: 20...28V ac/dc  |
| Accuracy (Setting and Indication) | Thermocouple<br>Within ± 0.2% of each input span ± 1 digit, or within ± 2 °C (4 °F), whichever is greater<br>However R, S input, 0...200 °C (0...400 °F): Within ± 6 °C (12 °F)<br>B input, 0...300 °C (0...600 °F): Accuracy is not guaranteed<br>K, J, E, T, N input, less than 0 °C (32 °F): Within ± 0.4% of input span ± 1 digit |
|                                   | RTD<br>Within ± 0.1% of each input span ± 1 digit, or within ± 1 °C (2 °F), whichever is greater  |
|                                   | DC current, voltage<br>Within ± 0.2% of each input span ± 1 digit   |
| Control output (OUT1)             | Relay contact<br>Control capacity: 3 A, 250 Vac (resistive load)<br>1A 250 Vac (inductive load cos φ = 0.4), Electrical life: 100,000 cycles  |
|                                   | Non-contact voltage (for SSR drive)<br>12 Vdc ± 15%, Max. 40 mA DC (short circuit protected)  |
| Alarm 1, Alarm 2                  | Relay contact 1a, Control capacity<br>3A 250 Vac (resistive load), Electrical life: 100,000 cycles  |
| Control output (OUT2)             | Relay contact 1a, Control capacity: 3 A, 250 Vac (resistive load), Electrical life: 100,000 cycles<br>Non-contact voltage (for SSR drive): 12 Vdc ± 15%, Max. 40 mA DC (short circuit protected)  |
| Power consumption                 | Approx. 8 VA  |
| Ambient temperature               | 0...50 °C (32...122 °F)   |
| Ambient humidity                  | 35...85% RH (No icing and condensation)   |
| Weight                            | Approx. 120 g (4.23 oz)   |

## 4. Dimensions and Installation of RTC48

### Installation Precautions

**⚠ WARNING**  
**UNINTENDED EQUIPMENT OPERATION**  
 Do not install the controller where:  
 • Ambient temperature is outside the range of 0 °C...50 °C (32 °F...122 °F) while in operation.  
 • Ambient humidity is more than 85% RH while in operation.  
 • Condensation can occur.  
 • Corrosive or combustible gases are present.  
 • There is vibration or shock higher than the specified value.  
 • Exposure to water oil, chemicals, steam or vapor.  
 • Exposure to dust, salty air, or air containing high concentrations of metal particles.  
 • Subject to electromagnetic interference from static electricity, magnetism, and external electromagnetic interference sources.  
 • Exposure to direct sunshine.  
 • Heat accumulation due to solar radiation.  
**Failure to follow these instructions can result in death or serious injury.**

**⚠ WARNING**  
**UNINTENDED EQUIPMENT OPERATION**  
 • Do not allow the openings around the controller to be blocked, heat dissipation ability will be reduced.  
 • Do not allow the ventilation openings on top of the terminal block to be blocked.  
**Failure to follow these instructions can result in death or serious injury.**

### 4.1 Dimensions of Controller

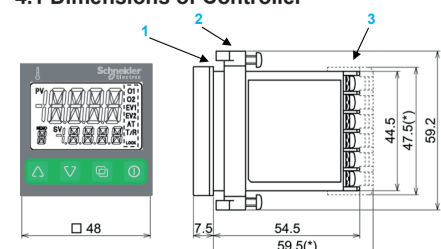

| Item | Description                      |
|------|----------------------------------|
| 1    | Gasket                           |
| 2    | Mounting frame                   |
| 3    | Terminal cover (sold separately) |

(\*) When Terminal cover (sold separately) is used

### 4.2 Panel Cut-out and Wiring

**⚠ CAUTION**  
**UNINTENDED EQUIPMENT OPERATION**  
 To ensure protection against dust and water (IP66):  
 • Use the appropriate panel cut out.  
 • Use the appropriate gasket and panel mounting adapter provided.  
 • Assemble the product according to installation guide.  
**Failure to follow these instructions can result in minor or moderate injury.**

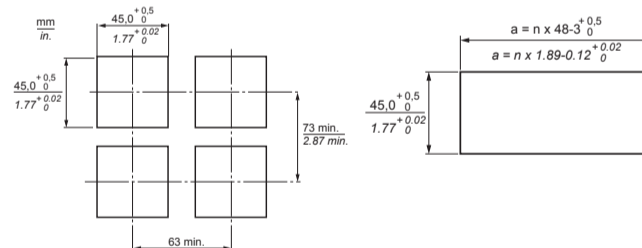

### Lead wire solderless terminal

Use a solderless terminal with an insulation sleeve in which an M3 screw fits as shown below.

The torque should be 0.63 N·m (5.57 lb-in)

φ3.2mm

5.8mm or less

3.2mm

5.8mm or less

### 4.3 How to Mount the RTC48

Mount the controller vertically to the flat, rigid panel to ensure it adheres to the Drip-proof/Dust-proof specification (IP66). Mountable panel thickness: 1...5 mm.

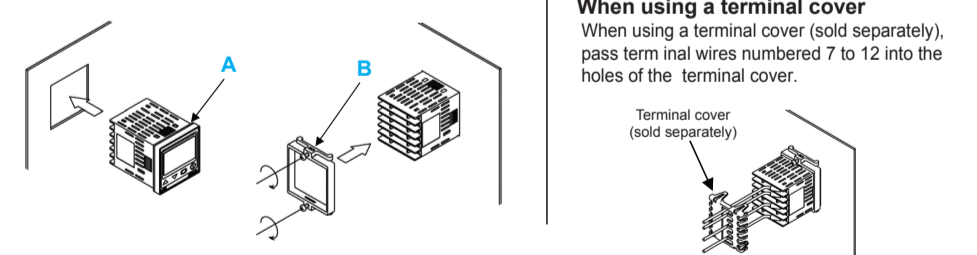

| Step | Action  |
|------|---|
| 1    | Insert the controller from the front side of the panel, using the gasket (A).   |
| 2    | Insert the mounting frame (B) until it comes into contact with the panel, and fasten with the screw. Tighten screws with one rotation upon the screw tips touching the panel. The torque is 0.05 to 0.06 N·m. |

### 4.4 How to Remove the Mounting Adapter and Unit

| Step | Action   |
|------|--|
| A    | Turn the power to the unit OFF, and disconnect all wires before removing the mounting frame.   |
| B    | Insert a flat blade screwdriver between the screw frame and unit.  |
| C    | Slowly push the frame upward using the screwdriver, while pushing the unit toward the panel.   |
| D    | Repeat step (B) and slowly push the frame downward using the screwdriver for the other side. You can remove the frame little by little by repeating these steps. |

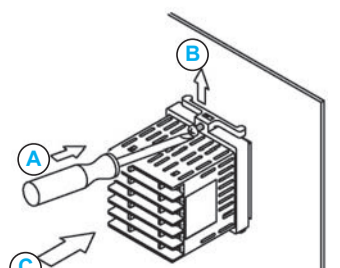

## 5. Wiring Diagram of RTC48

### ⚠ DANGER

#### HAZARD OF ELECTRIC SHOCK, EXPLOSION OR ARC FLASH

- Disconnect all power from the controller.
  - Always use a properly rated voltage sensing device to confirm power is off.
  - Use only the specified voltage when operating the controller.
- Failure to follow these instructions will result in death or serious injury.

### ⚠ CAUTION

#### UNINTENDED EQUIPMENT OPERATION

- To ensure protection against dust and water (IP66):
    - The terminal block of this instrument is designed to be wired from the left side. The lead wire must be inserted from the left side of the terminal, and fastened with the terminal screw. The torque should be 0.63 N·m (5.57 lb-in).
  - This instrument does not have a built-in power switch, circuit breaker, or fuse. It is necessary to install them near the controller. (Recommended fuse: Time-lag fuse, rated voltage 250 Vac, rated current 2A).
  - For a 24V ac/dc power source, do not confuse polarity when using direct current (DC).
  - Use a thermocouple and compensating lead wire according to the sensor input specifications of this controller.
  - Use the 3-wire RTD according to the sensor input specifications of this controller.
  - (+) side input terminal number of 0...5 Vdc, 1...5 Vdc, 0...10 Vdc differs from that of 0...1 Vdc.
  - (+) side input terminal number of 0...5 Vdc, 1...5 Vdc, 0...10 Vdc: 9
  - (+) side input terminal number of 0...1 Vdc: 10.
  - When using a relay contact output type, externally use a relay according to the capacity of the load to protect the built-in relay contact.
  - When wiring, keep input wires (thermocouple, RTD, and so on.) away from AC sources or load wires to avoid external interference.
- Failure to follow these instructions can result in minor or moderate injury.

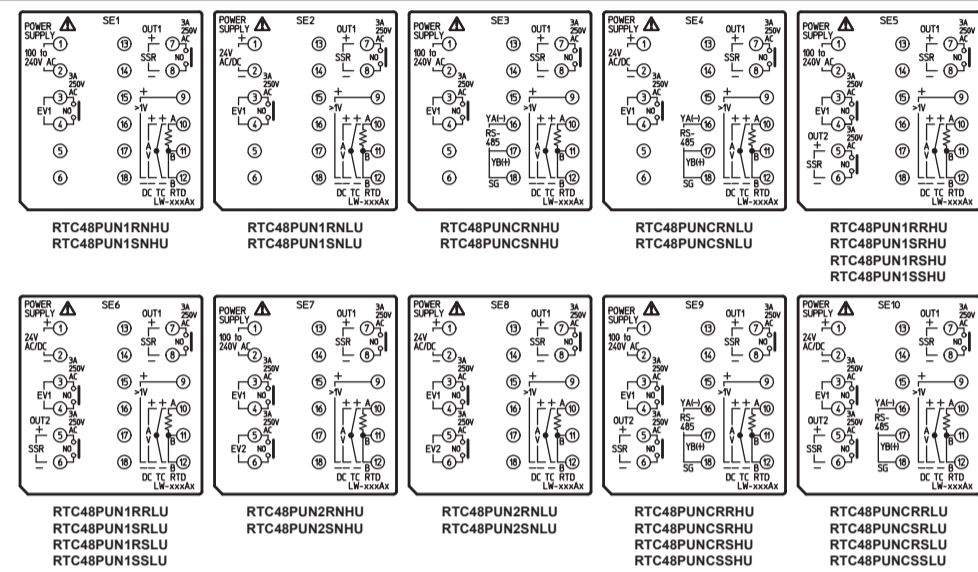

| Symbols | Description   |
|---------|---|
| EV1     | Alarm 1 output  |
| EV2     | Alarm 2 output  |
| O2      | Control output (OUT2)   |
| O1      | Control output (OUT1)   |
| DC      | DC current, DC voltage input (For DC voltage input, + side terminal number differs depending on the voltage input.) For DC current input, connect 50 Ω shunt resistor externally. |
| TC      | Thermocouple input  |
| RTD     | Resistance temperature detector input   |
| RS485   | Serial communication  |
| SSR     | Solid State Relay   |

## 6. Operation Flowchart

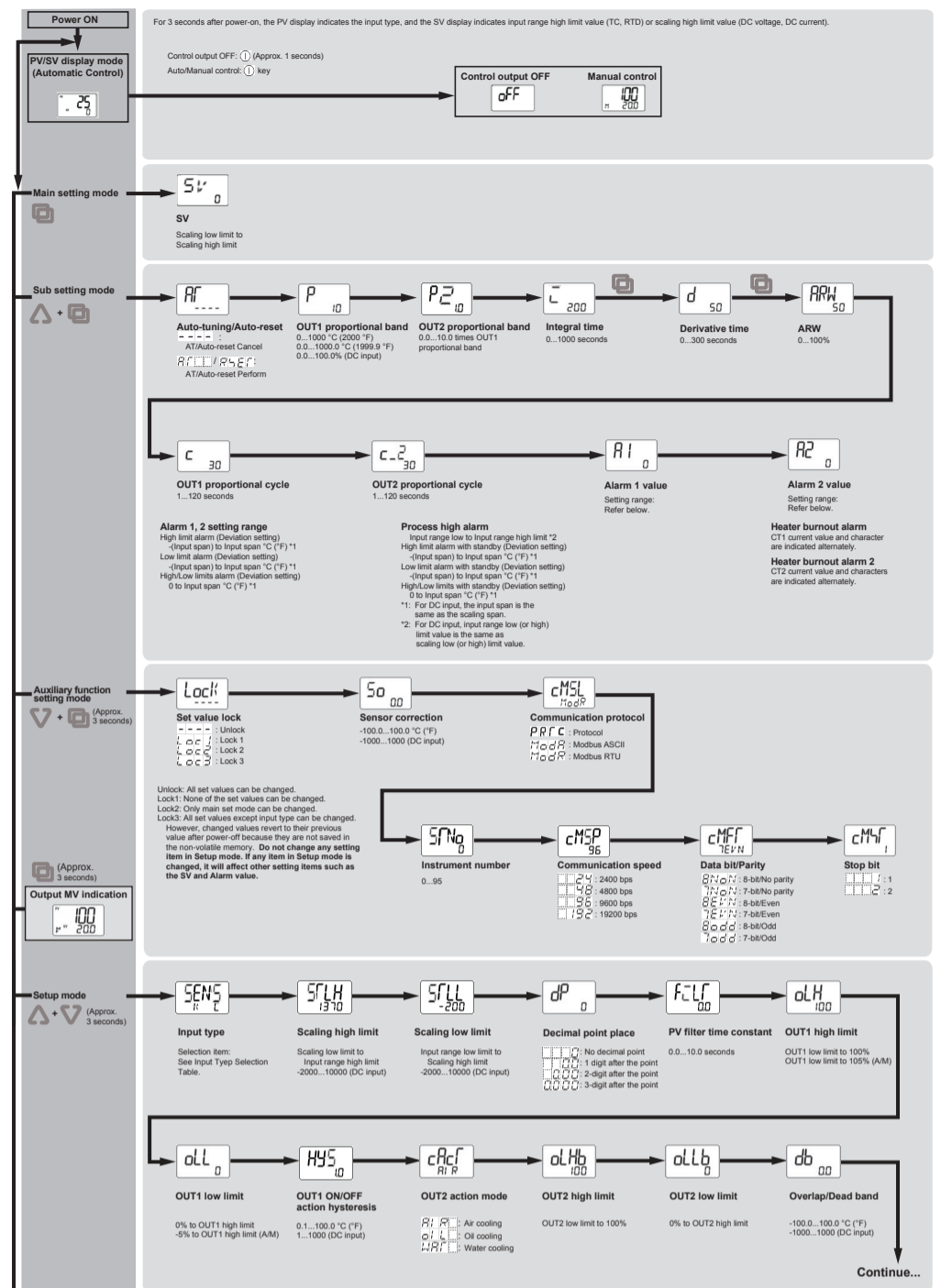

## 8. Alarm Type Selection

### Input type selection (Default OFF: No alarm action)

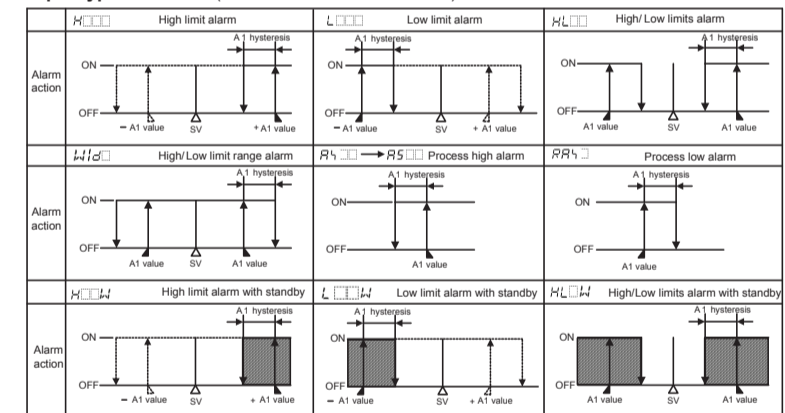

A1 = Alarm 1. For Alarm 2, read A2 for A1.

## 9. Basic Setting

After the unit is mounted to the control panel and wiring is completed, operate the unit following the procedures below.

| Step | Action  |
|------|---|
| 1    | Power ON RTC48.   |
| 2    | Set up the unit (Refer to Operation Flowchart). Setup should occur before using the controller, to set the input type (Refer to Input Type Selection), Alarm type (Refer to Alarm Type Selection), Direct/Reverse control, and so on in the Setup mode. If the specification is the same as the default value of RTC48, it is not necessary to set up the controller. |
| 3    | Turn the load circuit power ON. Control action starts.  |

### 9.1 Changing SV

The following steps explain how to set the SV to 100 °C (212 °F)

| Step | Action  | Remarks   |
|------|---|---|
| 1    | Press the  key in the PV/SV display mode.                                     | The display unit proceeds to Main Setting mode. |
| 2    | Use the  keys to set the SV.  | -   |
| 3    | Press the  key to register the SV.  | The display unit reverts to PV/SV display mode. |
| 4    | The control starts so as to keep measuring the temperature at 100 °C (212 °F) | -   |

### 9.2 Auto-tuning Perform/Cancel Mode (PID Control)

The following steps explain how to auto-tune the perform/cancel mode.

| Step | Action  | Remarks   |
|------|---|---|
| 1    | Press the  key while pressing the  key in the PV/SV display mode.                     | The display unit proceeds to Sub setting mode.  |
| 2    | Use the  key to select AT Perform or use the  key to select AT OFF.                   | -   |
| 3    | Press the  key to confirm the setting.  | The display unit reverts to PV/SV display mode. |
| 4    | While AT is performing, the AT indicator flashes, and it goes off if AT is cancelled. | -   |

## 7. Input Type Selection

### Input type selection [ SENS ] (Default: K: K, -200...137 °C)

| Key | Input Type   | Range                                       | Unit | Key | Input Type   | Range           | Unit |
|-----|--------------|---|------|-----|--------------|-----------------|------|
|     | K            | -200...1370                                 | °C   |     | K            | -320...2500     | °F   |
|     | K            | -200.0...400.0                              | °C   |     | K            | -320.0...750.0  | °F   |
|     | J            | -200...1000                                 | °C   |     | J            | -320...1800     | °F   |
|     | R            | 0...1760                                    | °C   |     | R            | 0...3200        | °F   |
|     | S            | 0...1760                                    | °C   |     | S            | 0...3200        | °F   |
|     | B            | 0...1820                                    | °C   |     | B            | 0...3300        | °F   |
|     | E            | -200...800                                  | °C   |     | E            | -320...1500     | °F   |
|     | T            | -200.0...400.0                              | °C   |     | T            | -320.0...750.0  | °F   |
|     | N            | -200...1300                                 | °C   |     | N            | -320...2300     | °F   |
|     | PL- II       | 0...1390                                    | °C   |     | PL- II       | 0...2500        | °F   |
|     | C(W/Re 5-26) | 0...2315                                    | °C   |     | C(W/Re 5-26) | 0...4200        | °F   |
|     | Pt100        | -200.0...850.0                              | °C   |     | Pt100        | -320.0...1500.0 | °F   |
|     | JPt100       | -200.0...500.0                              | °C   |     | JPt100       | -320.0...900.0  | °F   |
|     | Pt100        | -200...850                                  | °C   |     | Pt100        | -320...1500     | °F   |
|     | JPt100       | -200...500                                  | °C   |     | JPt100       | -320.0...900.0  | °F   |
|     | 4...20 mA    | -2000...10000 (Connect 50 Ω shunt resistor) |      |     |              |                 |      |
|     | 0...20 mA    |   |      |     |              |                 |      |
|     | 0...1 Vdc    |   |      |     |              |                 |      |
|     | 0...5 Vdc    |   |      |     |              |                 |      |
|     | 1...5 Vdc    | -2000...10000                               |      |     |              |                 |      |
|     | 0...10 Vdc   |   |      |     |              |                 |      |