

ConneXium

TCSESM-E Extended Managed Switch Installation Manual

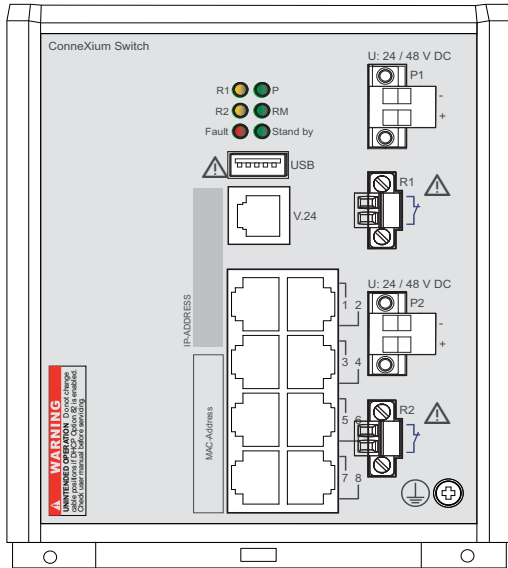

TCSESM083F23F1 / TCSESM083F23F1C

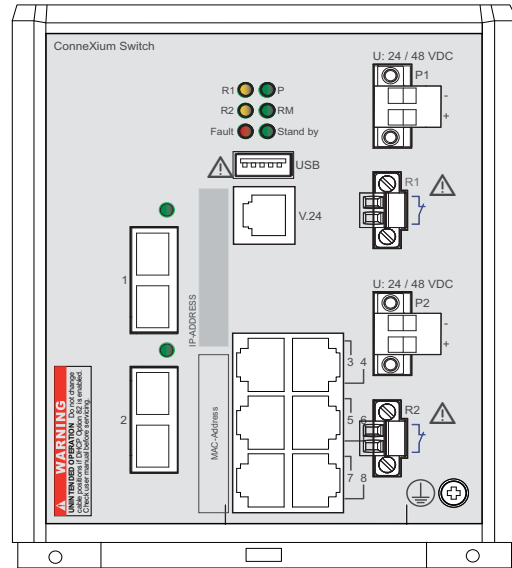

TCSESM063F2CU1 / TCSESM063F2CU1C
TCSESM063F2CS1 / TCSESM063F2CS1C

The information provided in this documentation contains general descriptions and/or technical characteristics of the performance of the products contained herein. This documentation is not intended as a substitute for and is not to be used for determining suitability or reliability of these products for specific user applications. It is the duty of any such user or integrator to perform the appropriate and complete risk analysis, evaluation and testing of the products with respect to the relevant specific application or use thereof. Neither Schneider Electric nor any of its affiliates or subsidiaries shall be responsible or liable for misuse of the information contained herein. If you have any suggestions for improvements or amendments or have found errors in this publication, please notify us.

You agree not to reproduce, other than for your own personal, noncommercial use, all or part of this document on any medium whatsoever without permission of Schneider Electric, given in writing. You also agree not to establish any hypertext links to this document or its content. Schneider Electric does not grant any right or license for the personal and noncommercial use of the document or its content, except for a non-exclusive license to consult it on an "as is" basis, at your own risk. All other rights are reserved.

All pertinent state, regional, and local safety regulations must be observed when installing and using this product. For reasons of safety and to help ensure compliance with documented system data, only the manufacturer must perform repairs to components.

When devices are used for applications with technical safety requirements, the relevant instructions must be followed.

Failure to use Schneider Electric software or approved software with our hardware products may result in injury, harm, or improper operating results.

Failure to observe this information can result in injury or equipment damage.

© 2018 Schneider Electric. All Rights Reserved.

Contents

	About this Manual	4
	Key	6
	Safety instructions	7
1	Description	20
1.1	General device description	20
1.2	Device versions	21
2	Assembly and start-up	23
2.1	Installing the device	23
2.1.1	Overview of installation	23
2.1.2	Unpacking and checking	24
2.1.3	Insert data in label area	24
2.1.4	Connecting the terminal blocks for supply voltage and signal contact	24
2.1.5	Installing the device	27
2.1.6	Installing the terminal blocks; start-up procedure	28
2.1.7	Connecting the data lines	29
2.2	Display elements	31
2.3	Basic set-up	34
2.4	Disassembly	36
3	Technical data	37

About this Manual

Validity Note

The technical characteristics of the devices described in this document also appear online. To access this information online:

Step	Action
1	Go to the Schneider Electric home page www.schneider-electric.com .
2	In the Search box type the reference of a product or the name of a product range. <input type="checkbox"/> Do not include blank spaces in the reference or product range. <input type="checkbox"/> To get information on grouping similar modules, use asterisks (*).
3	If you entered a reference, go to the Product Datasheets search results and click on the reference that interests you. If you entered the name of a product range, go to the Product Ranges search results and click on the product range that interests you.
4	If more than one reference appears in the Products search results, click on the reference that interests you.
5	Depending on the size of your screen, you may need to scroll down to see the data sheet.
6	To save or print a data sheet as a .pdf file, click Download XXX product datasheet.

The characteristics that are presented in this manual should be the same as those characteristics that appear online. In line with our policy of constant improvement, we may revise content over time to improve clarity and accuracy. If you see a difference between the manual and online information, use the online information as your reference.

Related Documents

Title	Reference Number
ConneXium TCSESM, TCSESM-E Managed Switch Redundancy Configuration User Manual	31007126
ConneXium TCSESM, TCSESM-E Managed Switch Basic Configuration User Manual	31007122
ConneXium TCSESM, TCSESM-E Managed Switch Command Line Interface Reference Manual	31007130
ConneXium TCSESM, TCSESM-E Managed Switch Web-based Interface Reference Manual	EIO0000000482
ConneXium TCSESM Managed Switch Installation Manual	31007118
ConneXium TCSESM-E Extended Managed Switch Installation Manual	EIO0000000529

You can download these technical publications and other technical information from our website at

<http://www.schneider-electric.com/ww/en/download>.

Note: The Glossary is located in the Reference Manual “Command Line Interface”.

The “Web-based Interface” reference manual contains detailed information on using the Web interface to operate the individual functions of the device.

The “Command Line Interface” reference manual contains detailed information on using the Command Line Interface to operate the individual functions of the device.

The “Installation” user manual contains a device description, safety instructions, a description of the display, and the other information that you need to install the device.

The “Basic Configuration” user manual contains the information you need to start operating the device. It takes you step by step from the first startup operation through to the basic settings for operation in your environment.

The “Redundancy Configuration” user manual contains the information you need to select a suitable redundancy procedure and configure that procedure.

Key

The symbols used in this manual have the following meanings:

▶	Listing
□	Work step
■	Subheading

Safety instructions

■ Important Information

Notice: Read these instructions carefully, and look at the equipment to become familiar with the device before trying to install, operate, or maintain it. The following special messages may appear throughout this documentation or on the equipment to warn of potential hazards or to call attention to information that clarifies or simplifies a procedure.



The additional of this symbol to a "Danger" or "Warning" safety label indicates that an electrical hazard exists, which will result in personal injury if the instructions are not followed.



This is the safety alert symbol. It is used to alert you to potential personal injury hazards. Obey all safety messages that follow this symbol to avoid possible injury or death.



DANGER

DANGER indicates an imminently hazardous situation which, if not avoided, **will result in** death or serious injury.



WARNING

WARNING indicates a potentially hazardous situation which, if not avoided, **can result in** death or serious injury.



CAUTION

CAUTION indicates a potentially hazardous situation which, if not avoided, **can result in** minor or moderate injury.

NOTICE

NOTICE is used to address practices not related to physical injury.

PLEASE NOTE: Electrical equipment must be installed, operated, serviced, and maintained only by qualified personnel. No responsibility is assumed by Schneider Electric for any consequences arising out of the use of this material. A qualified person is one who has skills and knowledge related to the construction and operation of electrical equipment and its installation, and has received safety training to recognize and avoid the hazards involved.

■ **Before you begin**

Do not use this product on machinery lacking effective point-of-operation guarding. Lack of effective point-of-operation guarding on a machine can result in serious injury to the operator of that machine.

 **WARNING**

UNGUARDED EQUIPMENT

- Do not use this software and related automation equipment on equipment which does not have point-of-operation protection.
- Do not reach into machinery during operation.

Failure to follow these instructions can result in death, serious injury, or equipment damage.

This automation equipment and related software is used to control a variety of industrial processes. The type or model of automation equipment suitable for each application will vary depending on factors such as the control function required, degree of protection required, production methods, unusual conditions, government regulations, etc. In some applications, more than one processor may be required, as when backup redundancy is needed.

Only you, the user, machine builder or system integrator can be aware of all the conditions and factors present during setup, operation, and maintenance of the machine and, therefore, can determine the automation equipment and the related safeties and interlocks which can be properly used. When selecting automation and control equipment and related software for a particular application, you should refer to the applicable local and national standards and regulations. The National Safety Council's Accident Prevention Manual (nationally recognized in the United States of America) also provides much useful information.

In some applications, such as packaging machinery, additional operator protection such as point-of-operation guarding must be provided. This is necessary if the operator's hands and other parts of the body are free to enter the pinch points or other hazardous areas and serious injury can occur. Software products alone cannot protect an operator from injury. For this reason the software cannot be substituted for or take the place of point-of-operation protection.

Ensure that appropriate safeties and mechanical/electrical interlocks related to point-of-operation protection have been installed and are operational before placing the equipment into service. All interlocks and safeties related to point-of-operation protection must be coordinated with the related automation equipment and software programming.

Note: Coordination of safeties and mechanical/electrical interlocks for point-of-operation protection is outside the scope of the Function Block Library, System User Guide, or other implementation referenced in this documentation.

■ **Start-up and test**

Before using electrical control and automation equipment for regular operation after installation, the system should be given a start-up test by qualified personnel to verify correct operation of the equipment. It is important that arrangements for such a check be made and that enough time is allowed to perform complete and satisfactory testing.

CAUTION

EQUIPMENT OPERATION HAZARD

- Verify that all installation and set up procedures have been completed.
- Before operational tests are performed, remove all blocks or other temporary holding means used for shipment from all component devices.
- Remove tools, meters, and debris from equipment.

Failure to follow these instructions can result in injury or equipment damage.

Follow all start-up tests recommended in the equipment documentation. Store all equipment documentation for future references.

Software testing must be done in both simulated and real environments.

Verify that the completed system is free from all short circuits and temporary grounds that are not installed according to local regulations (according to the National Electrical Code in the U.S.A, for instance). If high-potential voltage testing is necessary, follow recommendations in equipment documentation to help prevent accidental equipment damage.

Before energizing equipment:

- Remove tools, meters, and debris from equipment.
- Close the equipment enclosure door.
- Remove all temporary grounds from incoming power lines.
- Perform all start-up tests recommended by the manufacturer.

■ **Operation and adjustments**

The following precautions are from the NEMA Standards Publication ICS 7.1-1995 (English version prevails):

- ▶ Regardless of the care exercised in the design and manufacture of equipment or in the selection and ratings of components, there are hazards that can be encountered if such equipment is improperly operated.
- ▶ It is sometimes possible to misadjust the equipment and thus produce unsatisfactory or unsafe operation. Always use the manufacturer's instructions as a guide for functional adjustments. Personnel who have access to these adjustments should be familiar with the equipment manufacturer's instructions and the machinery used with the electrical equipment.
- ▶ Only those operational adjustments actually required by the operator should be accessible to the operator. Access to other controls should be restricted to help prevent unauthorized changes in operating characteristics.

■ **General safety instructions**

Electricity is used to operate this equipment. Comply with every detail of the safety requirements specified in the operating instructions regarding the voltages to apply.

[“Supply voltage” on page 11](#)

- Only qualified personnel should work on this device or in its vicinity. These personnel must be thoroughly familiar with all the hazard messages and maintenance procedures in accordance with this operating manual.
- The proper and safe operation of this device depends on proper handling during transport, proper storage and assembly, and conscientious operation and maintenance procedures.
- Never start operation with damaged components.
- Any work that may be required on the electrical installation may only be carried out by personnel trained for this purpose.

■ **Staff qualification requirements**

Only appropriately qualified staff should work on or near this equipment. Such staff must be thoroughly acquainted with all the hazard messages and maintenance measures contained in these operating instructions. The proper and safe operation of this equipment assumes proper transport, appropriate storage and assembly, and careful operation and maintenance.

Qualified staff are persons familiar with setting up, assembling, installation, starting up, and operating this product, and who have appropriate qualifications to cover their activities, such as:

- ▶ knowledge of how to switch circuits and equipment/systems on and off, ground them, and identify them in accordance with current safety standards
- ▶ training or instruction in accordance with current safety standards of using and maintaining appropriate safety equipment
- ▶ first aid training

■ **Usage**

The device may only be employed for the purposes described in the catalog, technical description, and manuals.

■ **Supply voltage**

- ▶ The device does not contain any service components. Internal fuses are only triggered if a fault is detected in the device.
- Apply supply voltage to the device if terminal blocks are wired and installed correctly as described in chapter [“Connecting the terminal blocks for supply voltage and signal contact”](#) on page 24.
- Connect the protective conductor with the ground screw before you set up the other connections. When removing the connections, you remove the protective conductor last.
- Make sure that the cross-section of the protective conductor cable is the same size as or bigger than the cross-section of the voltage supply cables.
- Only use connection cables that are permitted for the specified temperature range.

WARNING

LOSS OF COMMUNICATION

If the neutral conductor or the negative terminal of the supply voltage is not grounded, install a suitable input fuse.

Use a slow-blow fuse with a nominal rating of 6.3 A for the voltage supply input.

Failure to follow these instructions can result in death, serious injury, or equipment damage.

- Use a cable cross-section of at least 1.0 mm² (for North America, AWG 16) for the current conductor at the voltage input.
- Relevant for North America:
Only use 75 °C copper wire.

■ **Shielding ground**

The shield ground wire of the twisted pair lines is connected to the front panel as a conductor.

■ **Housing**

DANGER

HAZARD OF ELECTRIC SHOCK

Never insert sharp objects (small screwdrivers, wires, etc.) into the inside of the product.

Failure to follow these instructions will result in death, serious injury, or equipment damage.

CAUTION

OVERHEATING OF THE DEVICE

When installing the device, ensure that the ventilation slots are not covered. Make sure there is at least 10 cm (3.94 in) of space.

Failure to follow these instructions can result in death, serious injury, or equipment damage.

Only technicians authorized by the manufacturer are permitted to open the casing.

The device is grounded via the separate ground screw. It is located on the bottom left of the front panel.

- Make sure that the electrical installation meets local or nationally applicable safety regulations.
- The ventilation slots must not be covered to promote free air circulation.
- The clearance between the ventilation slots of the housing and other objects must be at least 10 cm (3.94 in).
- The device must be installed in the vertical position.
- If installed in a living area or office environment, the device must be operated exclusively in switch cabinets with fire protection characteristics according to EN 60950-1.
- Mount the device per instructions on page [27](#).

■ **Environment**

The device may only be operated at the specified surrounding air temperature (temperature of the surrounding air at a distance of up to 5 cm (1.97 in) from the device) and relative air humidity specified in the technical data.

- Install the device in a location where the climatic threshold values specified in the technical data will be observed.
- Use the device only in an environment within the pollution degree specified in the technical data.

■ **Instructions for Use in Hazardous Locations**

SUITABLE FOR USE IN CLASS I, DIVISION 2, GROUPS A, B, C AND D HAZARDOUS LOCATIONS, OR NONHAZARDOUS LOCATIONS ONLY.

WARNING

EXPLOSION HAZARD

Substitution of any components may impair suitability for CLASS I, DIVISION 2.

Failure to follow these instructions can result in death, serious injury, or equipment damage.



WARNING

EXPLOSION HAZARD

Do not disconnect equipment unless power has been switched off or the area is known to be non-hazardous.

Failure to follow these instructions can result in death, serious injury, or equipment damage.



WARNING

EXPLOSION HAZARD

Do not use USB connector, or connect or disconnect devices from it unless the area is known to be **non**-hazardous.

Failure to follow these instructions can result in death, serious injury, or equipment damage.

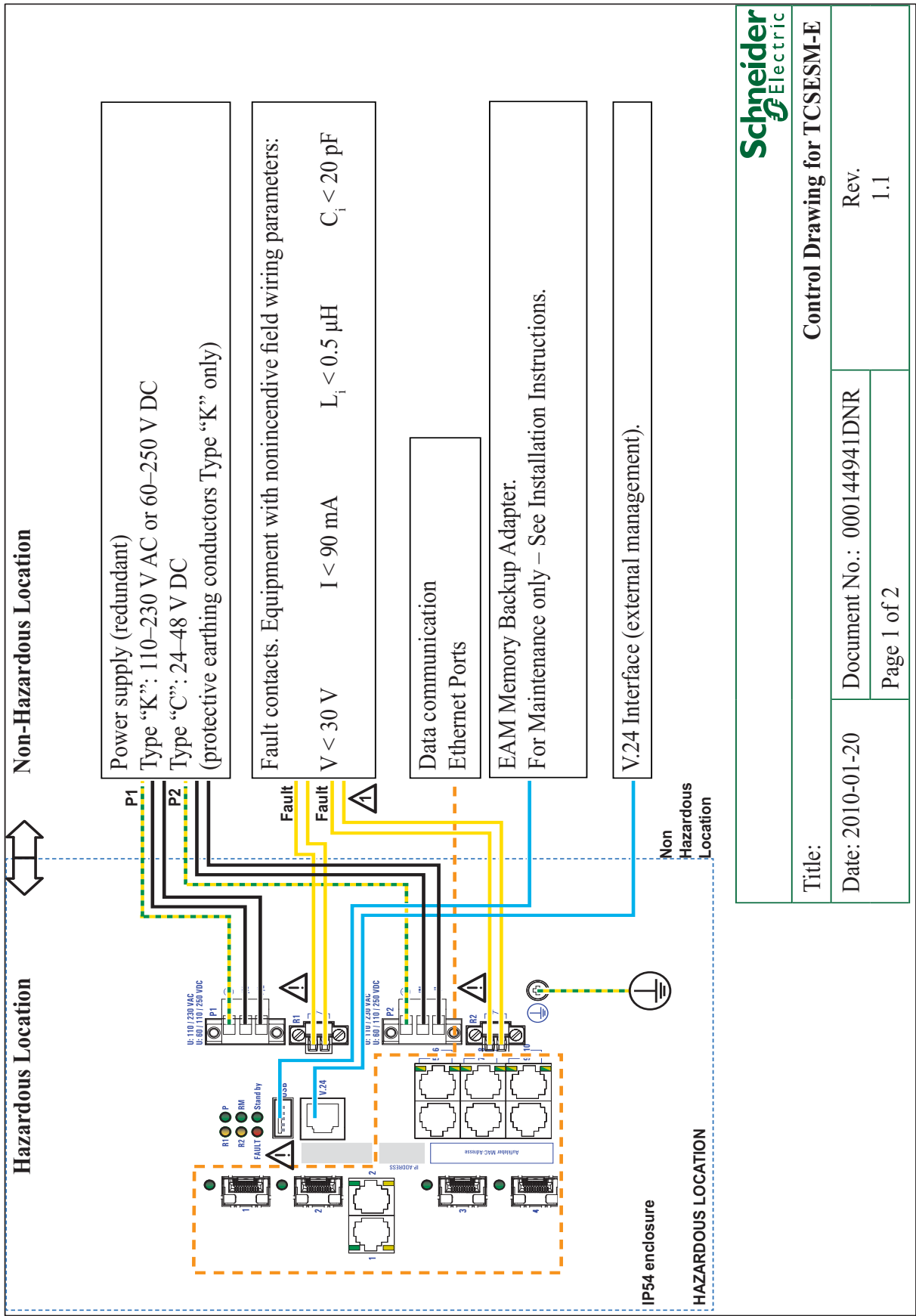

Schneider Electric	
Control Drawing for TCSESM-E	
Title:	Document No.: 000144941DNR
Date: 2010-01-20	Rev. 1.1
	Page 1 of 2

Notes:

The nonincendive field wiring circuit concept allows interconnection of nonincendive field wiring apparatus and associated nonincendive field wiring apparatus using any of the wiring methods permitted for unclassified locations when certain parameter conditions are met.

$$C_a \geq C_i + C_{\text{cable}}; L_a \geq L_i + L_{\text{cable}}$$

Nonincendive field wiring circuits must be wired in accordance with the National Electrical Code (NEC), NFPA 70, article 501.

Nonincendive Field Wiring Parameters:

Entity Parameters for Class I, Division 2 Groups A, B, C, D =>	V_{max} [V]	I_{max} [mA]	C_i [pF]	L_i [μH]
Connector: 2 pole	30	90	20	0.5
Contacts: Fault contacts				

WARNING!

EXPLOSION HAZARD – SUBSTITUTION OF ANY COMPONENTS MAY IMPAIR SUITABILITY FOR HAZARDOUS LOCATIONS OR EXPLOSIVE ATMOSPHERES.

EXPLOSION HAZARD – DO NOT DISCONNECT EQUIPMENT UNLESS POWER HAS BEEN SWITCHED OFF OR THE AREA IS KNOWN TO BE NON-HAZARDOUS.

DO NOT OPEN WHEN ENERGIZED.

Control Drawing for TCSESM-E

Title:

Date: 2010-01-20

Document No.: 000144941DNR

Page 2 of 2

Rev.

1.1

■ Instructions for Use in Zone 2 Explosive Atmospheres

List of Standards:

- ▶ EN 60079-0:2012/A11:2013
- ▶ EN 60079-15:2010

- Make sure that the device has the following label:



II 3G Ex nA IIC T4 Gc Dekra 12ATEX0238X

Ambient rating and temperature code

for types TCSESM083F23F1, TCSESM063F2CU1 and TCSESM063F2CS1:

T4: 0 °C ≤ Ta ≤ +60 °C

for types TCSESM083F23F1C, TCSESM063F2CU1C and TCSESM063F2CS1C:

T4: -40 °C ≤ Ta ≤ +85 °C

Special conditions for safe use in Zone 2 according to the EU Directive 2014/34/EU



- The modules shall be installed in a suitable enclosure in accordance with EN 60079-15 providing a degree of protection of at least IP54 according to EN 60529, taking into account the environmental conditions under which the equipment will be used.
- When the temperature under rated conditions exceeds 70 °C at the cable or conduit entry point, or 80 °C at the branching point of the conductors, the temperature specification of the selected cable and cable entries shall be in compliance with the actual measured temperature values.
- Connectors shall be connected or disconnected exclusively in dead-voltage state.
- The USB port shall remain disconnected.

■ **CE marking**

The labeled devices comply with the regulations contained in the following European directive(s):

2014/30/EU (EMC)

Directive of the European Parliament and of the Council on the harmonisation of the laws of the Member States relating to electromagnetic compatibility.

2011/65/EU (RoHS)

Directive of the European Parliament and of the Council on the restriction of the use of certain hazardous substances in electrical and electronic equipment.

In accordance with the above-named EU directive(s), the EU conformity declaration will be at the disposal of the relevant authorities at the following address:

Schneider Electric Systems USA, Inc.
38 Neponset Avenue
Foxboro, Massachusetts 02035-2037
United States of America

The product can be used in the industrial sector.

- ▶ Interference immunity: EN 61000-6-2
- ▶ Emitted interference: EN 55032

■ **LED or laser components**

LED or LASER components according to IEC 60825-1 (2014):

CLASS 1 LASER PRODUCT

CLASS 1 LED PRODUCT

■ **FCC note:**

This device complies with part 15 of the FCC rules. Operation is subject to the following two conditions: (1) this device may not cause harmful interference; (2) this device must accept any interference received, including interference that may cause undesired operation.

Appropriate testing has established that this device fulfills the requirements of a class A digital device in line with part 15 of the FCC regulations.

These requirements are designed to provide sufficient protection against interference when the device is being used in a business environment.

The device creates and uses high frequencies and can also radiate these frequencies. If it is not installed and used in accordance with this operating manual, it can cause radio transmission interference. The use of this device in a residential area can also cause interference, and in this case the user is obliged to cover the costs of removing the interference.

■ **Recycling note**

After usage, this device must be disposed of properly as electronic waste, in accordance with the current disposal regulations of your county, state, and country.

1 Description

1.1 General device description

The TCSESM-E devices are designed for the special requirements of industrial automation. They meet the relevant industry standards, provide very high operational reliability, even under extreme conditions, and also provide long-term reliability and flexibility.

The devices allow you to set up switched industrial Ethernet networks that conform to the IEEE 802.3 standard.

The devices work without a fan.

The voltage is supplied redundantly.

Mount the devices by

- ▶ simply snapping them onto a DIN rail

Depending on the device variant, you can choose various media to connect terminal devices and other infrastructure components:

- ▶ twisted pair cable
- ▶ multimode F/O
- ▶ singlemode F/O

The twisted pair ports support:

- ▶ Autocrossing
- ▶ Autonegotiation
- ▶ Autopolarity

There are a number of convenient options for managing the device.

Administer your devices via:

- ▶ a Web browser
- ▶ Telnet
- ▶ a V.24 interface (locally on the device)

Product configuration data can be provided by:

- ▶ diagnosis displays
- ▶ displaying the operating parameters
- ▶ a label area for the IP address

The devices provide you with a large range of functions:

- ▶ Redundancy functions
 - ▶ Rapid Spanning Tree Protocol (RSTP)
 - ▶ HIPER-Ring
 - ▶ Fast HIPER-Ring
 - ▶ Media Redundancy Protocol (MRP)

- ▶ Redundant coupling
- ▶ Redundant power supply
- ▶ Security
 - ▶ Protection from unauthorized access
 - ▶ Blocking of unauthorized messages (MAC or IP based)
- ▶ Synchronized system time in the network
- ▶ Network load control
- ▶ Network filter
- ▶ Operation diagnosis
- ▶ Diagnostics (hardware self-testing)
- ▶ Reset
- ▶ Priority
- ▶ VLAN
- ▶ Topology Discovery
- ▶ Web based Interface
- ▶ Command Line Interface CLI
- ▶ SNMP
- ▶ 802.1x port authentication
- ▶ Real Time Clock

1.2 Device versions

Part number	Part number	Description
8 port version	TCSESM083F23F1	8 x 10/100 TX managed
	TCSESM063F2CU1	6 x 10/100 TX managed 2 x 100 FX-MM managed
	TCSESM063F2CS1	6 x 10/100 TX managed 2 x 100 FX-SM managed
	TCSESM083F23F1C	8 x 10/100 TX managed, Conformal Coating
	TCSESM063F2CU1C	6 x 10/100 TX managed 2 x 100 FX-MM managed, Conformal Coating
	TCSESM063F2CS1C	6 x 10/100 TX managed 2 x 100 FX-SM managed, Conformal Coating
Accessories	TCSEAM0100 Adapter	Memory Back-up Adapter
	490NTRJ11 cable	Terminal cable

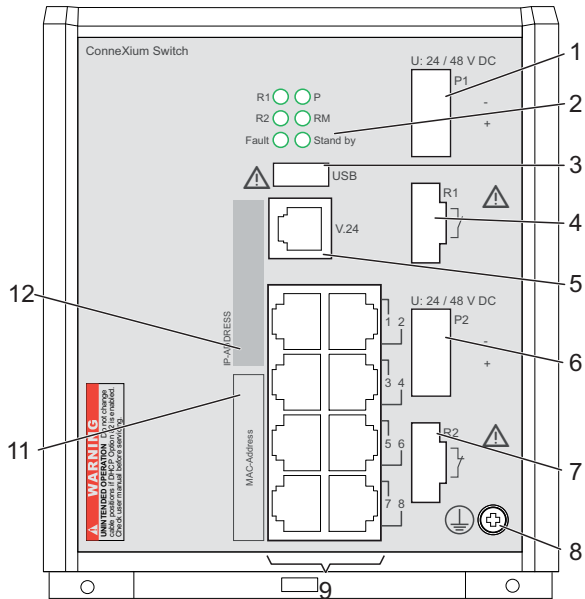

TCSESM083F23F1 / TCSESM083F23F1C

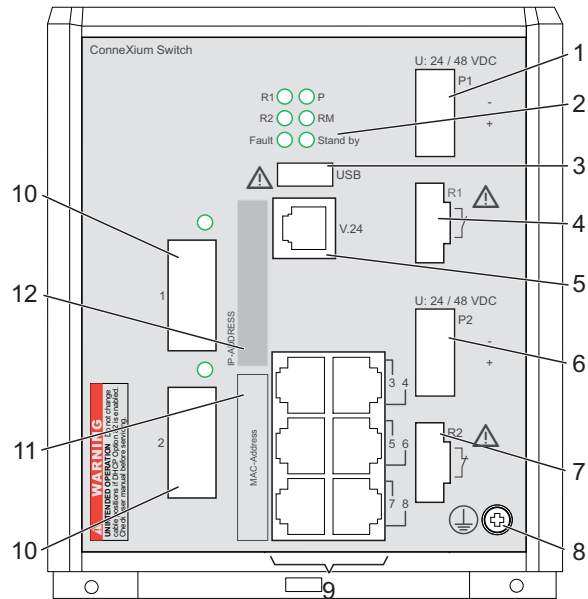

TCSESM063F2CU1 / TCSESM063F2CU1C
TCSESM063F2CS1 / TCSESM063F2CS1C

Figure 1: The figure shows the versions of the TCSESM-E.

- 1 – voltage range 1 (nominal voltage 24 V DC to 48 V DC)
- 2 – LED display elements
- 3 – USB interface
- 4 – signal contact 1
- 5 – V.24 connection for external management
- 6 – voltage range 2 (nominal voltage 24 V DC to 48 V DC)
- 7 – signal contact 2
- 8 – protective ground (PE)
- 9 – ports in compliance with 10/100BASE-T(X) (RJ45 connections)
 - LAN only
- 10 – port 1 + port 2:
 - TCSESM063F2CU1 / TCSESM063F2CU1C:
Multimode FX, DSC, 100 Mbit/s – LAN only
 - TCSESM063F2CS1 / TCSESM063F2CS1C:
Singlemode FX, DSC, 100 Mbit/s – LAN only
- 11 – MAC address field
- 12 – IP address field

2 Assembly and start-up

2.1 Installing the device

Two or more devices configured with the same IP address can cause unpredictable operation of your network.



WARNING

UNINTENDED EQUIPMENT OPERATION

Establish and maintain a process for assigning unique IP addresses to all devices on the network.

Failure to follow these instructions can result in death, serious injury, or equipment damage.



WARNING

UNINTENDED OPERATION

Do not change cable positions if DHCP Option 82 is enabled. Check the Basic Configuration user manual before servicing (refer to DHCP OPTION 82 topic).

Failure to follow these instructions can result in death, serious injury, or equipment damage.

2.1.1 Overview of installation

On delivery, the device is ready for operation.

The following steps should be performed to install and configure a device:

- ▶ [Unpacking and checking](#)
- ▶ [Insert data in label area](#)
- ▶ [Connecting the terminal blocks for supply voltage and signal contact](#)
- ▶ [Installing the device](#)
- ▶ [Installing the terminal blocks; start-up procedure](#)
- ▶ [Connecting the data lines](#)

2.1.2 Unpacking and checking

- Check whether the package includes all items named in section “Scope of delivery” on page 39.
- Check the individual parts for transport damage.

2.1.3 Insert data in label area

The information field for the IP address on the front of the device helps you to structure your network installation clearly.

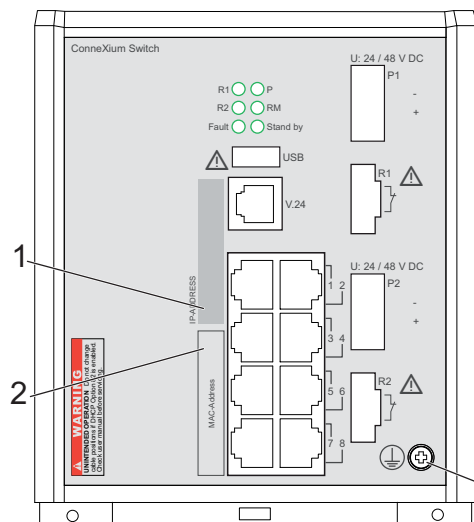

Figure 2: Label area for IP address of device
1 – IP address of device (label area)
2 – MAC address of device (label)

2.1.4 Connecting the terminal blocks for supply voltage and signal contact

The supply voltage is connected via a 2-pin terminal block with screw locking.
The signal contacts are connected via a 2-pin terminal block with screw locking.

■ Supply voltage



DANGER

HAZARD OF ELECTRIC SHOCK OR BURN

When the module is operated with direct plug-in power units, use only:

- SELV supply units that comply with IEC 60950/EN 60950 and
- (in USA and Canada) Class 2 power units that comply with applicable national or regional electrical codes

Connect the ground wire to the PE terminal (where applicable) before you establish any further connections. When you remove connections, disconnect the ground wire last.

Failure to follow these instructions will result in death, serious injury, or equipment damage.

Redundant power supplies can be used. Both inputs are uncoupled. There is no distributed load. With redundant supply, the power supply unit supplies the device only with the higher output voltage. The supply voltage is electrically isolated from the housing.

Note: With non-redundant supply voltage, the device reports inoperable supply voltage. You can help prevent this message by applying the supply voltage via both inputs, or by changing the configuration.

The supply voltage is connected via pin 1 and pin 2.

Figure	Pin	Assignment	Power supply
	1	Minus terminal of the supply voltage	Nominal voltage DC: 24 - 48 V Voltage range DC: 18 - 60 V (incl. max. tolerances), SELV Connection type: 2-pin terminal block Power failure bridging: > 10 ms for 20.4 V DC Fuse: installed in power supply unit
	2	Plus terminal of the supply voltage	

Table 1: Connecting the supply voltage

- Pull the terminal block off the device.
- Connect the supply voltage lines.

Note: Relevant for North America:

The torque for tightening the supply voltage terminal block on the device is 4.5 lb in (0.51 Nm).

■ Signal contact



Figure 3: Pin assignment of the signal contact

You have two signal contacts for each device.

- ▶ The signal contact (“FAULT”, for pin assignment of terminal block, see [figure 3](#)) monitors the functioning of the device, thus enabling remote diagnostics. You can specify the type of function monitoring in the Management.
- ▶ You can also use the switch Web page to switch the signal contact manually and thus control external devices.

The potential-free signal contact (relay contact, closed circuit) reports through a break in contact:

- ▶ The detected inoperability of at least one of the two voltage supplies (voltage supply 1 or 2 is below the threshold value).
- ▶ Loss of connection to at least one port.
The link state can be masked for each port using the configuration. In the state of delivery, link monitoring is inactive.
- ▶ The temperature threshold has been exceeded or has not been reached.
- ▶ The removal of the Memory Backup Adapter.

The following condition is also reported in RM mode:

- ▶ Ring redundancy reserve is available. On delivery, there is no ring redundancy monitoring.
- Pull the terminal block off the device.
- Connect the signal lines.

Note: Relevant for North America:

The tightening torque for fixing the signal contact terminal block to the device is 3 lb in (0.34 Nm).

2.1.5 Installing the device

You can mount the device on the DIN rail.

■ Mounting on the DIN rail

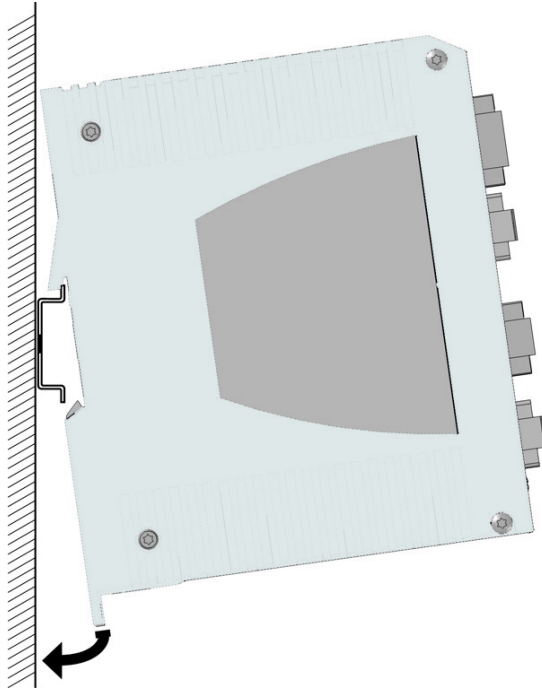
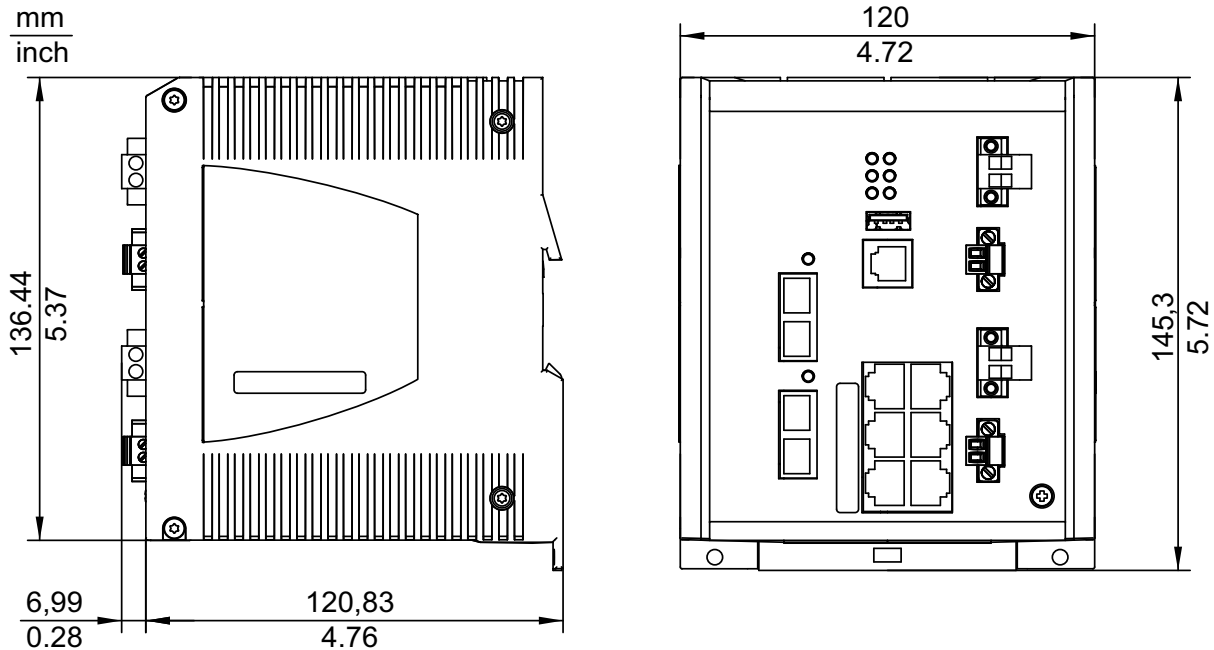

Figure 4: Mounting on the DIN rail

- Mount the device on a 35 mm DIN rail in accordance with DIN EN 60715.
- Attach the upper snap-in guide of the device into the DIN rail and press the device down against the DIN rail until it snaps into place.

Note: The shielding ground of the industrial connectable twisted pair lines is connected to the lower panel as a conductor.

■ Dimension drawings



■ Grounding

The device is grounded via the separate ground screw on the front panel of the device.

The devices have a protective conductor connection.

- Connect the protective conductor to the ground screw of the device.
- Connect the protective conductor before you set up the other connections. When removing the connection, you remove the protective conductor last.
- Connect both protective conductors if your device is equipped with two power supplies units.

2.1.6 Installing the terminal blocks; start-up procedure

■ Mounting the terminal blocks

- Mount the terminal blocks for the voltage supply and signal contact on the front of the device using screws.

■ Startup procedure

By connecting the voltage supply via the terminal blocks, you start the operation of the device.

2.1.7 Connecting the data lines

You can connect terminal devices and other segments on the ports of the device via twisted pair cables or F/O cables.

- Install the data lines according to your requirements.

■ 10/100 Mbit/s twisted pair connection

These connections are RJ45 sockets.

10/100 Mbit/s TP ports enable the connection of terminal devices or independent network segments according to the IEEE 802.3 10BASE-T/100BASE-TX standard.

These ports support:

- ▶ Autonegotiation (data rate and duplex mode)
- ▶ Autopolarity
- ▶ Autocrossing (if autonegotiation is activated)
- ▶ 100 Mbit/s half-duplex mode, 100 Mbit/s full duplex mode
- ▶ 10 Mbit/s half-duplex mode, 10 Mbit/s full duplex mode

Delivery state: autonegotiation activated

The socket housing is electrically connected to the bottom panel.

Figure	Pin	Function
	1+2	One line pair: receiver path
	3+6	One line pair: sender path
	4,5,7,8	Not used

Table 2: Pin assignment of a TP/TX interface in MDI-X mode, RJ45 socket

Note: In substation applications, the RJ45 ports are used to connect to additional communication devices such as routers or telecommunication multiplexers that are installed in close proximity to the device (i.e. less than 3 meters / 9.83 ft). It is not recommended to use these ports for connection to field devices across longer distances which could cause a significant increase in the ground potential (Ground Potential Rise GPR, i.e. more than 2500 V).

■ **100 Mbit/s F/O connection**

These connections are DSC connectors.

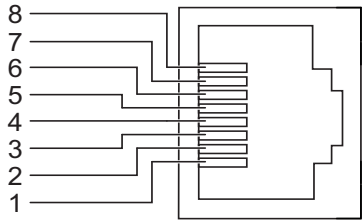
100 MBit/s F/O ports enable the connection of terminal devices or independent network segments in compliance with the IEEE 802.3 100BASE-FX standard.

These ports support:

- ▶ Full or half duplex mode

Delivery state: full duplex FDX

Note: Make sure that the SM ports are only connected with SM ports, and MM ports only with MM ports.

Note: LED or LASER components according to IEC 60825-1 (2014):

CLASS 1 LASER PRODUCT

CLASS 1 LED PRODUCT

2.2 Display elements

After establishing the operating voltage, the software starts and initializes itself. Afterwards, the device performs a self-test. During this process, various LEDs light up. The process lasts around 40 seconds.

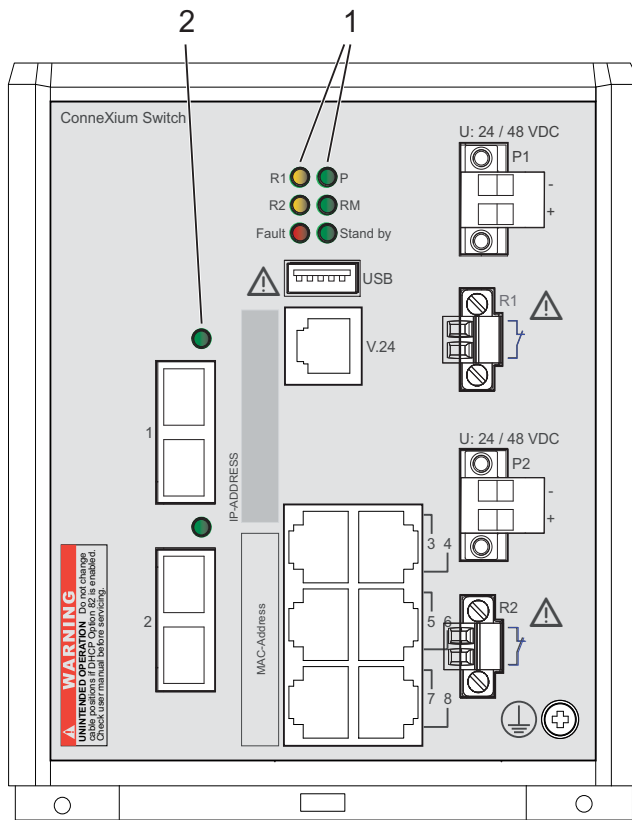

TCSESM063F2CU1 / TCSESM063F2CS1

Figure 5: LED display elements
1 – Device state
2 – Port state

■ Device state

These LEDs provide information about conditions which affect the operation of the whole device.



Figure 6: Device status LEDs

P - Power (green/yellow LED) Meaning	
Glowing green	Device variants with 1 power supply unit: Supply voltage is on
Glowing yellow	Device variants with 2 power supply units: There is only one supply voltage (P1 or P2) on

P - Power (green/yellow LED) Meaning	
Not glowing	Supply voltage is too low

RM - Ring Manager (green/yellow LED)	
Glowing green	RM function active, redundant port disabled
Glowing yellow	RM function active, redundant port enabled
Not glowing	RM function not active
Flashing green	Incorrect configuration of the HIPER-Ring (e.g. the ring is not connected to the ring port).

RM and stand-by during read and write access - display saving processes	
Flashing alternately	A detected error during saving process.
LED's flash synchronously, two times a second	Loading configuration from the Memory Backup Adapter EAM.
LED's flash synchronously, once a second	Saving the configuration in the Memory Backup Adapter EAM.

LED	Display	Color	Activity	Meaning
Stand by	Stand-by	green	Lights up	Standby mode enabled
			none	Stand-by mode not enabled
	Dual RSTP error	green	flashing	Dual DRSTP is activated, however, the device does not communicate any data between the Dual RSTP instances and reports one of the following states:: <ul style="list-style-type: none"> ▶ The device does not find a coupling partner. ▶ The coupling ports are incorrectly configured. ▶ A loop has occurred.

Applies to software releases previous to 06.00:

LED	Display	Color	Activity	Meaning
FAULT	Signal contact 1	red	Lights up	The signal contact is open - it is reporting a detected error.
			none	The signal contact is closed - it is not reporting any detected errors.

Applies to software release 06.00 and higher:

LED	Display	Color	Activity	Meaning
FAULT	Signal contact 1	red	Lights up	The signal contact is open - it is reporting a detected error.
			none	The signal contact is closed - it is not reporting any detected errors.
	Duplicate IP detection	red	flashes 4 times a period	Reports an IP conflict.

Applies to software releases previous to 06.00:

LED	Display	Color	Activity	Meaning
R1	Signal contact 1	yellow	Lights up	The signal contact is closed in manual operation.
			none	The signal contact is open in manual operation.
R2	Signal contact 2	yellow	Lights up	The signal contact is closed in manual operation.
			none	The signal contact is open in manual operation.

Applies to software release 06.00 and higher:

LED	Display	Color	Activity	Meaning
R1	Signal contact 1	yellow	Lights up	The signal contact is open.
			none	The signal contact is closed.
R2	Signal contact 2	yellow	Lights up	The signal contact is open.
			none	The signal contact is closed.

If the manual setting is active on the signal contact, then the error display is independent of the setting of the signal contact.

■ Port state

These LEDs display port-related information. During the boot phase, they indicate the status of the boot process.

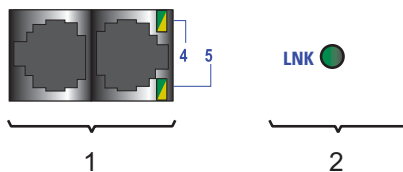

Figure 7: Port status LEDs

- 1 – Port status LEDs for double-row RJ45 sockets: one LED per port, glowing/flashing either green or yellow.
- 2 – Port status LEDs for DSC, SFP

1 to n - data, link status (green/yellow LED)	Meaning
Not glowing	No valid connection
Glowing green	Valid connection
Flashing green (1 time a period)	Port is switched to stand-by
Flashing green (3 time a period)	Port is disabled
Flashing yellow	Data reception at corresponding port

2.3 Basic set-up

The IP parameters must be entered when the device is installed for the first time.

The device provides the following options for configuring IP addresses:

- ▶ Configuration via V.24 connection
- ▶ Configuration via the switch configurator software
- ▶ Configuration via BOOTP
- ▶ Configuration via DHCP
- ▶ Configuration via the Memory Back-up Adapter (TCSEAM 0100)

Further information on the basic settings of the device can be found in the “Basic Configuration” user manual on the CD ROM.

■ Default settings

- ▶ IP address: The device looks for the IP address using DHCP
- ▶ Management password:
user, password: public (read only)
admin, password: private (read/write)
- ▶ V.24 data rate: 9,600 Baud
- ▶ Ring redundancy: disabled
- ▶ Ethernet ports: link status is not evaluated (signal contact)
- ▶ Optical ports: Full duplex
TP ports: Autonegotiation
- ▶ Ring Manager: disabled
- ▶ Stand-by coupling: disabled
- ▶ Rapid Spanning Tree (RSTP): enabled

■ USB interface

The USB socket has an interface for the local connection of a Memory Back-up Adapter (EAM). The EAM is used for saving/loading the configuration data and diagnostic information, and for loading the software.

Figure	Pin	Operation
	1	VCC (VBus)
	2	- Data
	3	+ Data
	4	Ground (GND)

Table 3: Pin assignment of the USB interface

■ V.24 interface (external management)

The V.24 interface is an RJ11 socket.

The V.24 interface is a serial interface which allows you to connect the following devices locally:

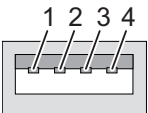
- ▶ An external management station (VT100 terminal or PC with appropriate terminal emulation). This enables you to set up a connection to the Command Line Interface (CLI) and to the system monitor.
- ▶ A Memory Back-up Adapter (TCSEAM0100)

VT100 terminal settings	
Speed	9600 Baud
Data	8 bit
Stopbit	1 bit
Handshake	off
Parity	none

The socket housing is electrically connected to the front panel of the device.

The V.24 interface is not electrically isolated from the supply voltage.

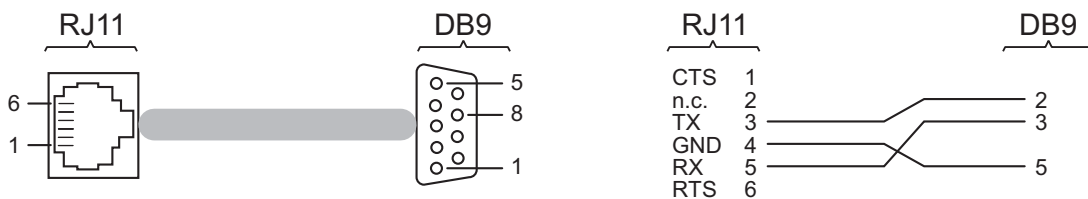

Figure 8: Pin assignment of the V.24 interface and the DB9 connector

Note: You can order the terminal cable separately (ref #: 490NTRJ11).

You will find a description of the V.24 interface in the “Basic Configuration User Manual” on the CD-ROM.

2.4 Disassembly

■ Removing the device from the DIN rail

- To take the device off the DIN rail, insert a screwdriver horizontally under the housing into the locking slide, pull it (without tipping the screwdriver) downwards and lift the device upwards.

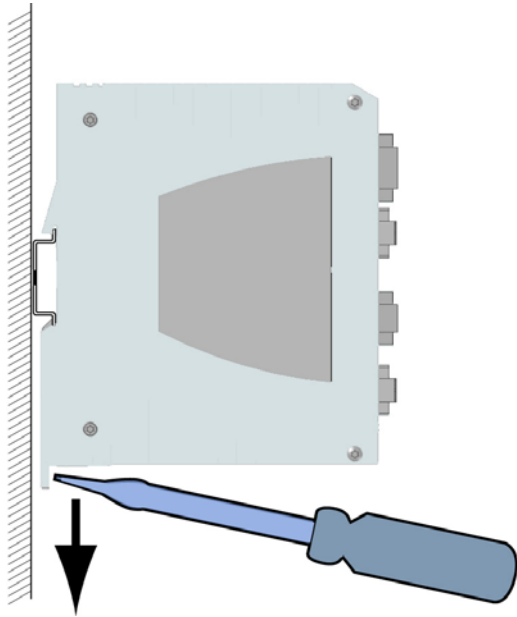

Figure 9: Removal from the DIN rail

3 Technical data

■ General technical data

Dimensions W x H x D	TCSESM-E	120 mm x 137 mm x 115 mm (4.72 in x 5.39 in x 4.53 in)
Weight	TCSESM-E	approx. 1 kg (2.20 lb)
Power supply	Nominal voltage DC Voltage range DC Connection type Power failure bridging Fuse	24 - 48 V 18 - 60 V (incl. max. tolerances), SELV 2-pin terminal block > 10 ms for 20.4 V DC installed in power supply unit
Signal contact	Nominal value Connection type	2 A at 30 V DC 0.2 A at 125 V DC 0.1 A at 250 V DC 2-pin terminal block
Environment	Storage temperature (ambient air temperature) Humidity Atmospheric pressure	Standard: -40 °C to +85 °C (-40 °F to +185 °F) Extended: -40 °C to +85 °C (-40 °F to +185 °F) 10% to 95% (non-condensing) Up to 2000 m / 1.24 miles (795 hPa), higher altitudes on request
Operating temperature	Standard	0 °C to +60 °C (+32 °F to +140 °F)
Pollution degree		2
Protection classes	Laser protection Protection class	Class 1 according to EN 60825-1 (2007) IP 30

■ EMC and immunity

IEC/EN 61850-3:2002 EMI TYPE tests, test in comp. with	Description	Test Level
IEC/EN 61000-4-2	ESD Contact discharge Air discharge	+/- 8 kV +/- 15 kV
IEC/EN 61000-4-3	Electromagnetic field 80 - 2700MHz	20 V/m
IEC/EN 61000-4-4	Burst DC Power line AC Power line Data line	+/- 4 kV (2.5 kHz) +/- 4 kV (2.5 kHz) +/- 4 kV (2.5 kHz)
IEC/EN 61000-4-5	Surge DC Power line AC Power line Data line	+/- 2 kV line / ground; +/- 1 kV line / line +/- 4 kV line / ground; +/- 2 kV line / line +/- 4 kV line / ground
IEC/EN 61000-4-6	Conducted interference voltage 50kHz - 80MHz	10 V

IEC/EN 61850-3:2002 EMI TYPE tests, test in comp. with	Description	Test Level
IEC/EN 61000-4-12	Damped oscillation	
	DC Power line	+/- 2.5kV line / ground; +/- 1kV line / line
	AC Power line	+/- 2.5kV line / ground; +/- 1kV line / line
	Data line	+/- 2.5kV line / ground; +/- 1kV line / line
IEC 60255-5	Electrical strength	
	DC Power line Signal contact	500 VAC ^a 2000 VAC

a. This voltage is limited to 60 VDC (1 mA) by protective components.

IEEE 1613:2009 EMI TYPE tests, test in comp. with	Description	Test Level
IEEE C37.90.3	ESD	
	Contact discharge Air discharge	+/- 8 kV +/- 15 kV
IEEE C37.90.2	Electromagnetic field 80 - 2700MHz	35 V/m (peak)
IEEE C37.90.1	Burst	
	DC Power line AC Power line	+/- 4 kV (2.5 kHz) +/- 4 kV (2.5 kHz)
	Data line	+/- 4 kV (2.5 kHz)
IEEE C37.90.1	Damped oscillation	
	DC Power line	+/- 2.5kV line / ground; +/- 1kV line / line
	AC Power line	+/- 2.5kV line / ground; +/- 1kV line / line
	Data line	+/- 2.5kV line / ground; +/- 1kV line / line
IEEE C37.90	H.V. Impulse	
	DC Power line AC Power line	+/- 5 kV line / ground +/- 5 kV line / ground
IEEE C37.90	Electrical strength	
	DC Power line Signal contact	500 VAC ^a 2000 VAC

a. This voltage is limited to 60 VDC (1 mA) by protective components.

Environment TYPE tests, test in comp. with	Description	Test Level
IEC 60068-2-1	Cold	-40 °C (-40 °F), 16 hours
IEC 60068-2-2	Dry heat	+85 °C (+185 °F), 16 hours
IEC 60068-2-30	Relative humidity	95 % (non-condensed), +55 °C (+131 °F) 4 cycles
IEC 60068-2-6	Vibration, test Fc	2- 9 Hz with 3 mm amplitude 1 g at 9 - 200 Hz 1.5 g at 200 - 500 Hz
IEC 60068-2-27	Shock, test Ea	15 g at 11 ms

EMC emitted interference	
EN 55032	Class A
FCC 47 CFR Part 15	Class A
German Lloyd	Classification and Construction Guidelines VI-7-3 Part 1 Ed.2003

■ Network range

TP port	
Length of a twisted pair segment	max. 100 m (cat5e cable with 1000BASE-T)

Table 4: TP port 10BASE-T / 100BASE-TX / 1000BASE-T

Product code	Wave length	Fiber	System attenuation	Example for F/O cable length ^a	Fiber attenuation	BLP/Dispersion
TCSESM ...CU1 / CU1C	MM	1300 nm	50/125 μm	0-8 dB	0-5 km	1.0 dB/km 800 MHz*km
TCSESM ...CS1 / CS1C	SM	1300 nm	9/125 μm	0-16 dB	0-25 km	0.4 dB/km 3.5 ps/(nm*km)

Table 5: F/O port 100BASE-FX

a. Including 3 dB system reserve when compliance with the fiber data is observed.

MM = Multimode, SM = Singlemode, LH = Singlemode Longhaul

■ Power consumption/power output

TCSESM-E device	Maximum power consumption	Power consumption
2 x FX port (100 Mbit/s) and 6 x TX port (100 Mbit/s)	12 W	41 Btu (IT)/h
8 x TX port (100 Mbit/s)	10 W	34 Btu (IT)/h

■ Scope of delivery

Device	Scope of delivery
TCSESMxx	Device
	Terminal block for supply voltage and signal contact
	CD-ROM (includes user technical documentation)

■ Order numbers/product description



Part number	Part number	Description
8 port version	TCSESM083F23F1	8 x 10/100 TX managed
	TCSESM063F2CU1	6 x 10/100 TX managed 2 x 100 FX-MM managed
	TCSESM063F2CS1	6 x 10/100 TX managed 2 x 100 FX-SM managed
	TCSESM083F23F1C	8 x 10/100 TX managed, Conformal Coating
	TCSESM063F2CU1C	6 x 10/100 TX managed 2 x 100 FX-MM managed, Conformal Coating
	TCSESM063F2CS1C	6 x 10/100 TX managed 2 x 100 FX-SM managed, Conformal Coating
Accessories	TCSEAM0100 Adapter	Memory Back-up Adapter
	490NTRJ11 cable	Terminal cable

■ Underlying norms and standards

Name	
EN 61000-6-2	Generic norm – immunity in industrial environments
EN 55032	Electromagnetic compatibility of multimedia equipment – Emission Requirements
EN 61131-2	Programmable logic controllers
EN 50121-4	Railway applications - EMC - emitted interference and interference immunity for signal and telecommunication systems
EN 50155	Railway applications - Electronic equipment used on rolling stock
FCC 47 CFR Part 15	Code of Federal Regulations
IEC/EN 61850-3	Communications networks and systems in substations
IEEE 1613	Standard Environment and Testing Requirements for Communication Networking Devices in Electric Power Substations

Table 6: List of norms and standards. Certified devices are marked with a certification indicator.

■ Certifications

Standard	
UL 508 / CSA C22.2 No.142	Safety for Industrial Control Equipment 
ISA 12.12.01 / CSA C22.2 No.213	Electrical Equipment for Use in Class I and Class II, Div. 2 and Class III Hazardous (Classified) Locations 
Germanischer Lloyd	Rules for Classification and Construction VI-7-2 – GL
BUREAU VERITAS	Rules for the Classification of Steel Ships
Lloyd's Register	Marine applications for use in environmental categories ENV 1, ENV 2, ENV 3. Exclusively the following devices have this certification: <ul style="list-style-type: none"> ▶ TCSESM083F23F1 ▶ TCSESM063F2CU1 ▶ TCSESM063F2CS1

The TCSESM-E switches have CE certifications.