

How to connect **Actassi S-One Unshielded** connector to reach **high performance**

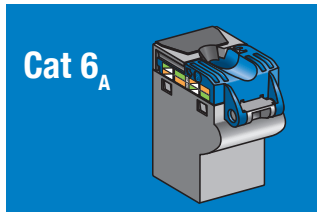

PoE+
4P PoE+
DC power 100W

Life Is On

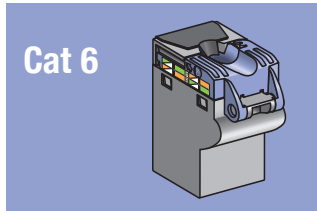
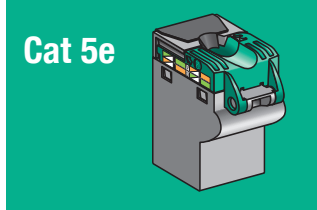
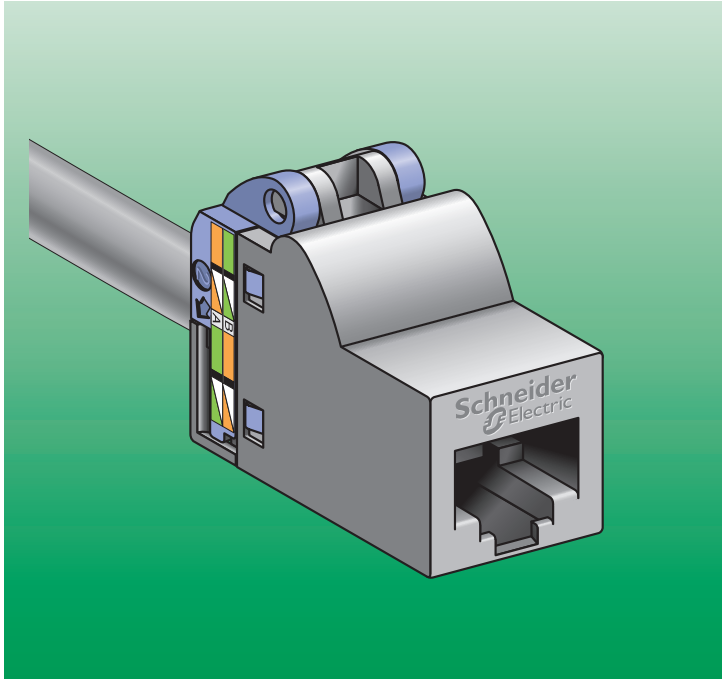

U/UTP Ø 6 mm

CL-C U/UTP

Cat 6

b*



CL-MNC U/UTP

Cat 5e

b*

CL-MNC U/UTP

Cat 6

b*



U/UTP Ø 7 mm

VDICD60X218

Cat 6_A

C*



ActassiS-One Unshielded

Actassi S-One Unshielded Cat 6

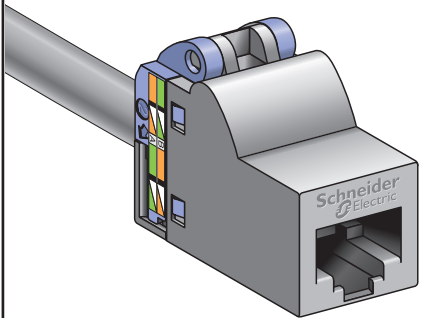

U/UTP

Cat 5e
Cat 6
Ø 6 mm

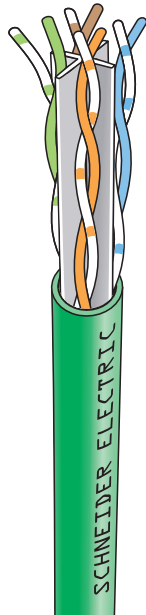

VDIR580020

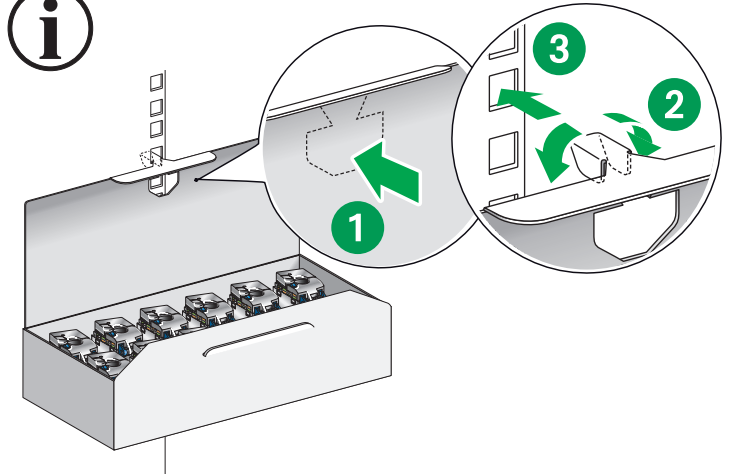
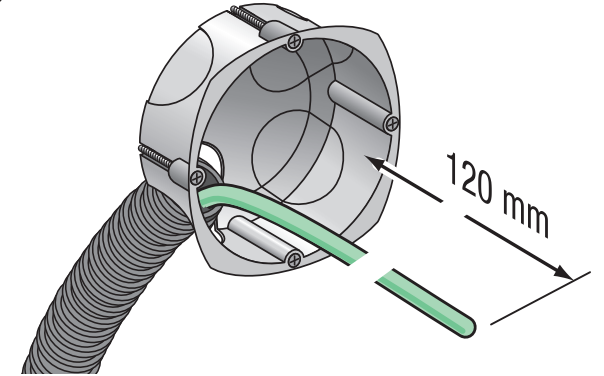

A

Cat 5e
Cat 6
Ø 6 mm

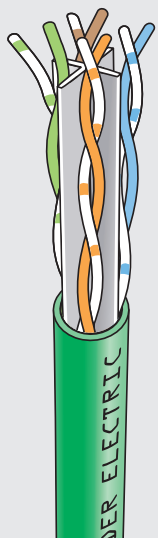

U/UTP
Class b

Cat 5e

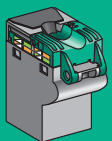

Cat 6

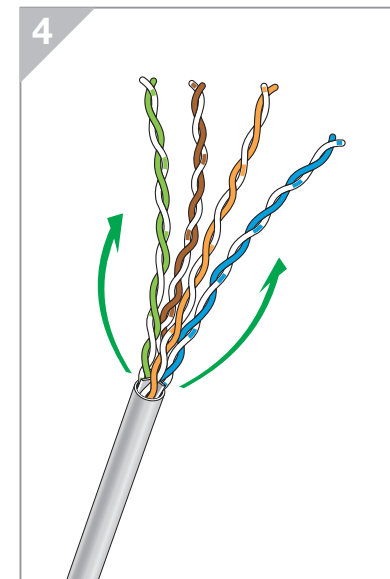
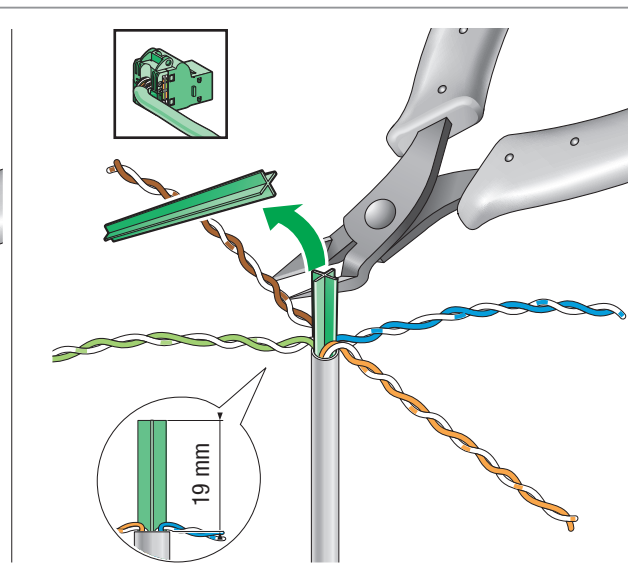
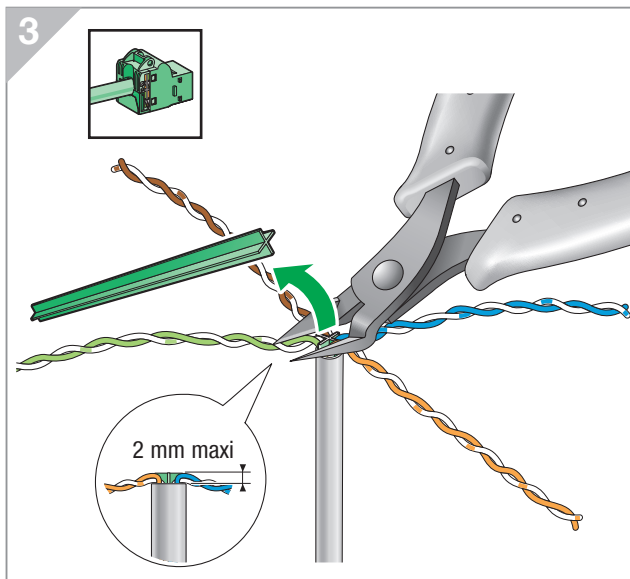
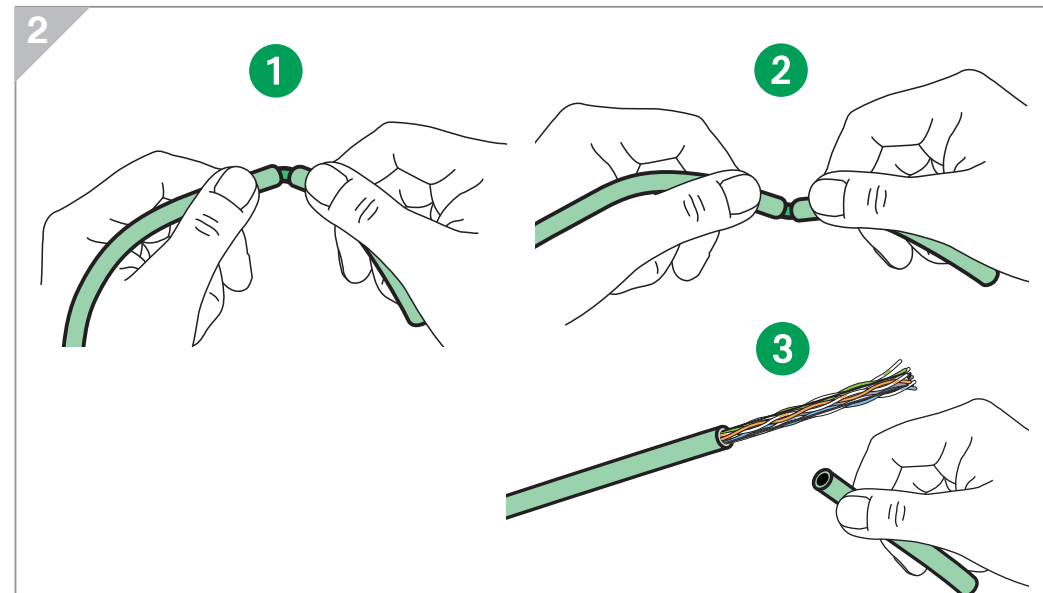
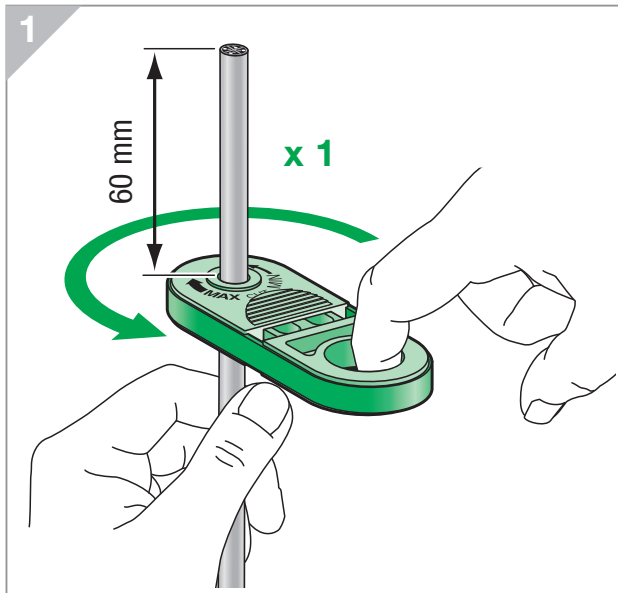
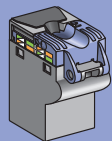

B

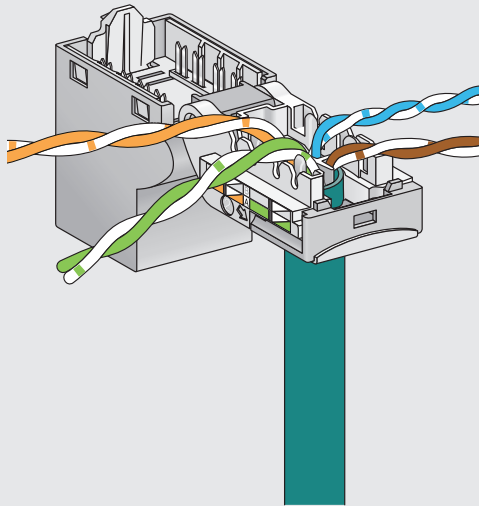

Cat 5e



Cat 6

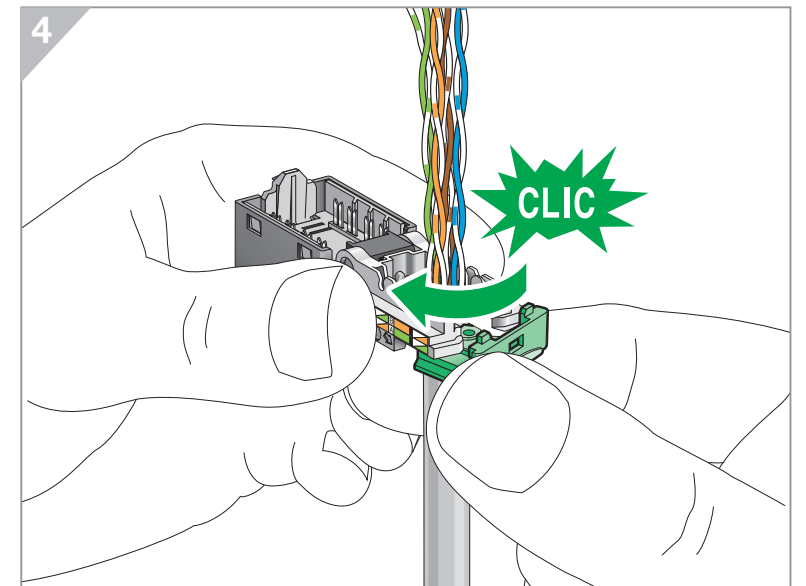
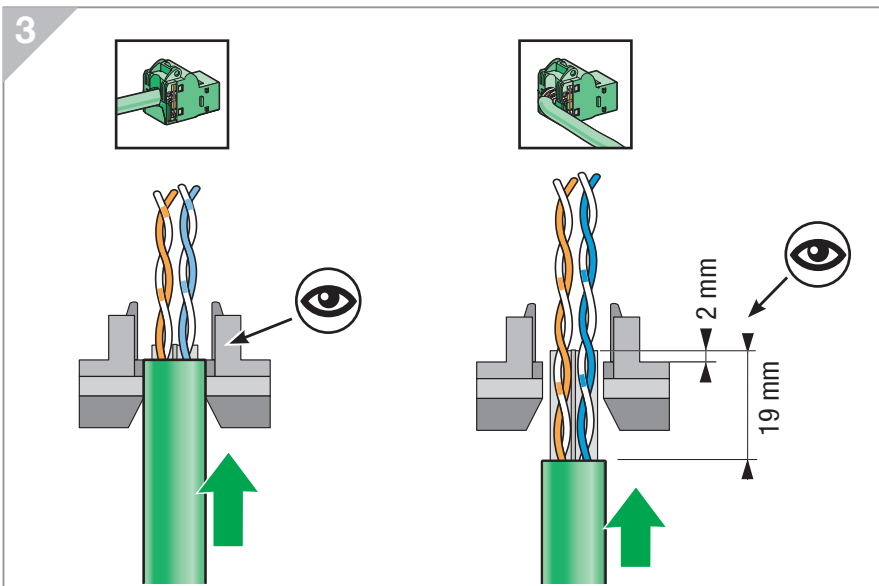
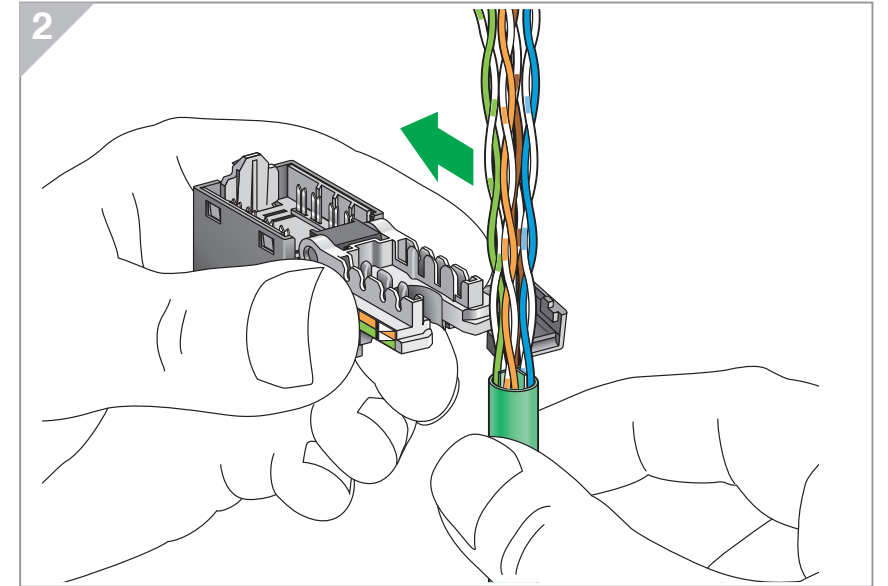
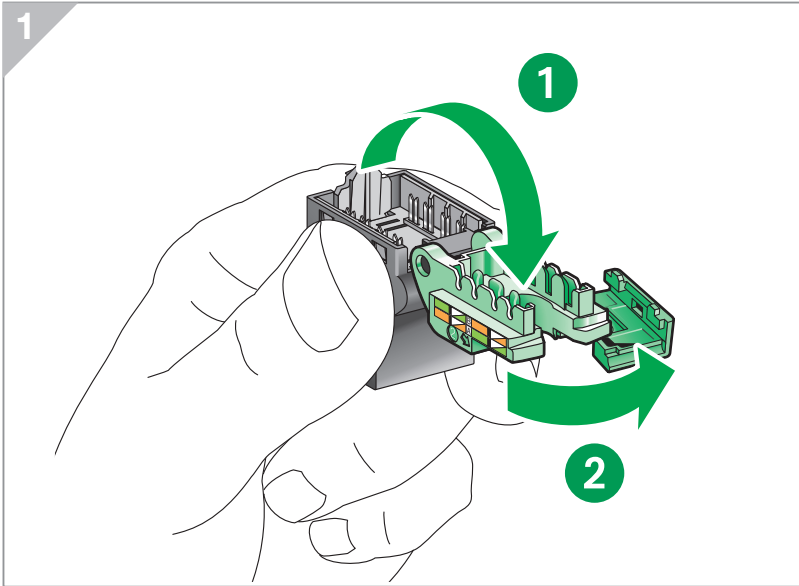
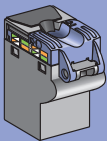

B

Convention B

How to prepare a **U/UTP** cable with The norm **EIA-TIA 568B** to reach **high performance** ?

EIA-TIA 568B (100Ω)

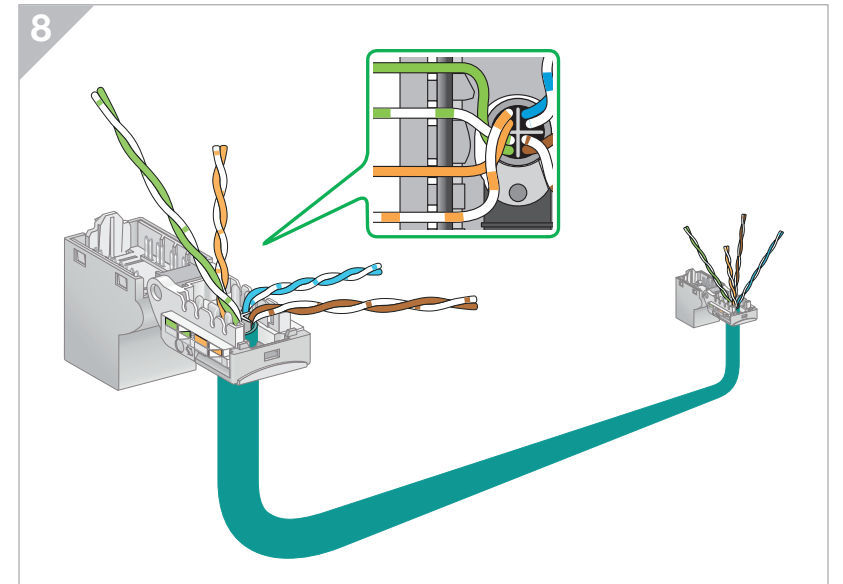
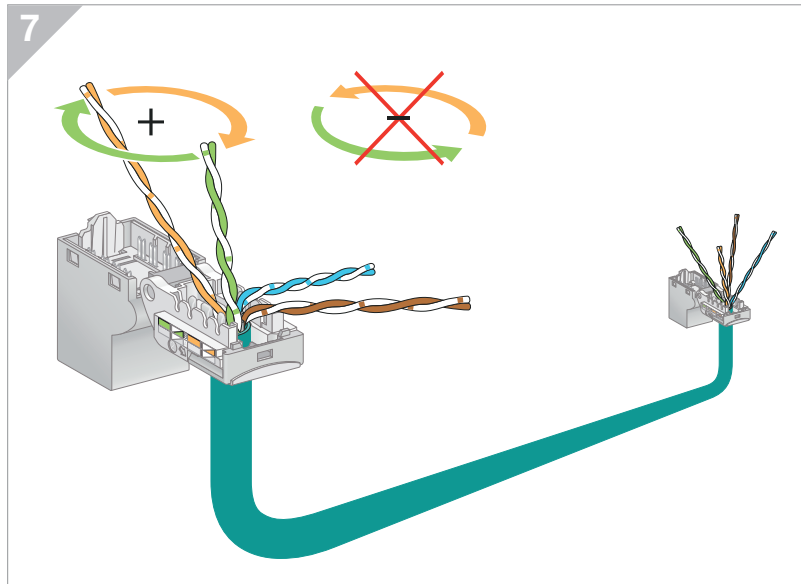
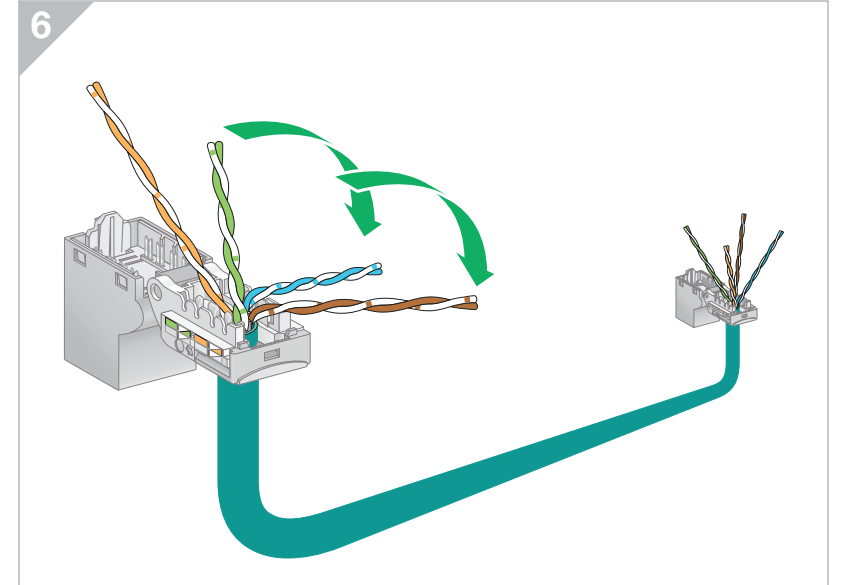
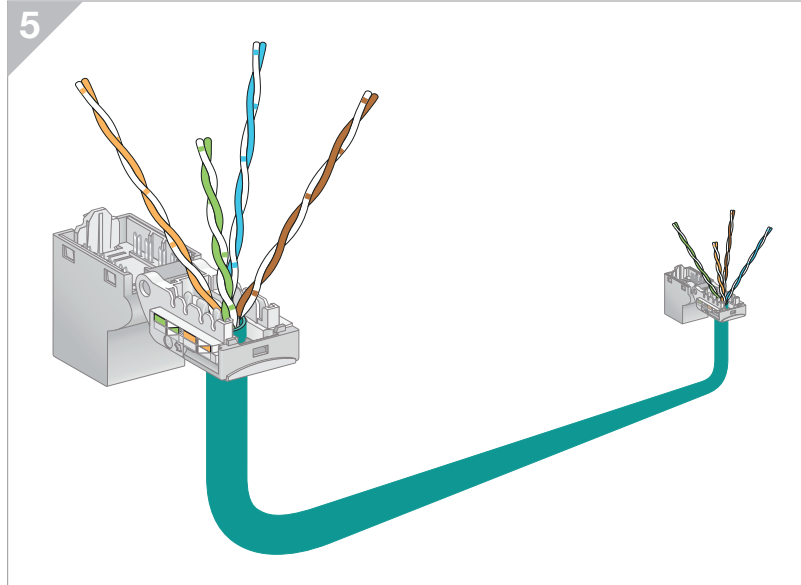
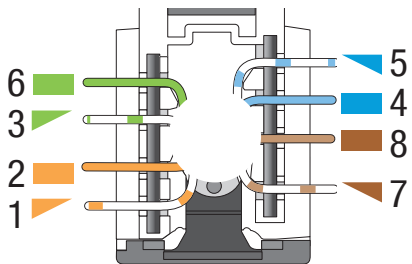

B

Convention B

How to prepare a **U/UTP** cable with The norm **EIA-TIA 568B** to reach **high performance** ?

EIA-TIA 568B (100Ω)

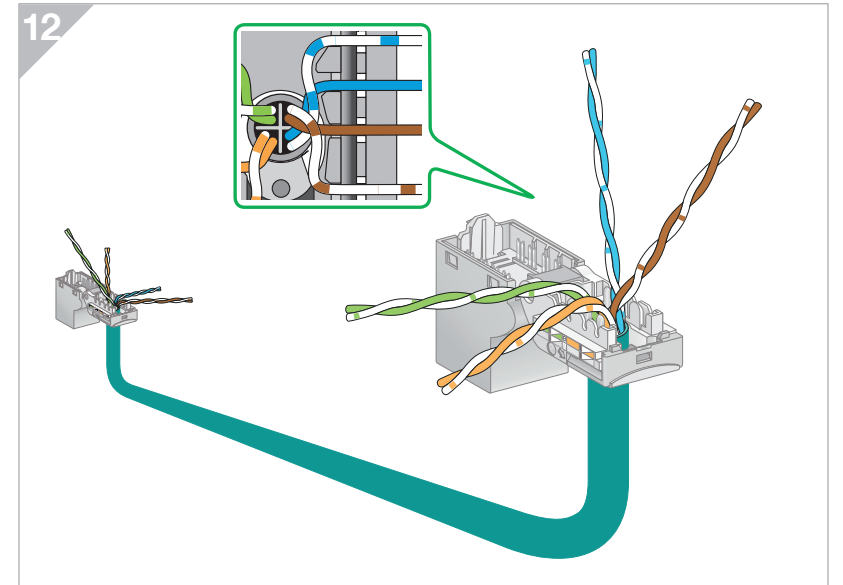
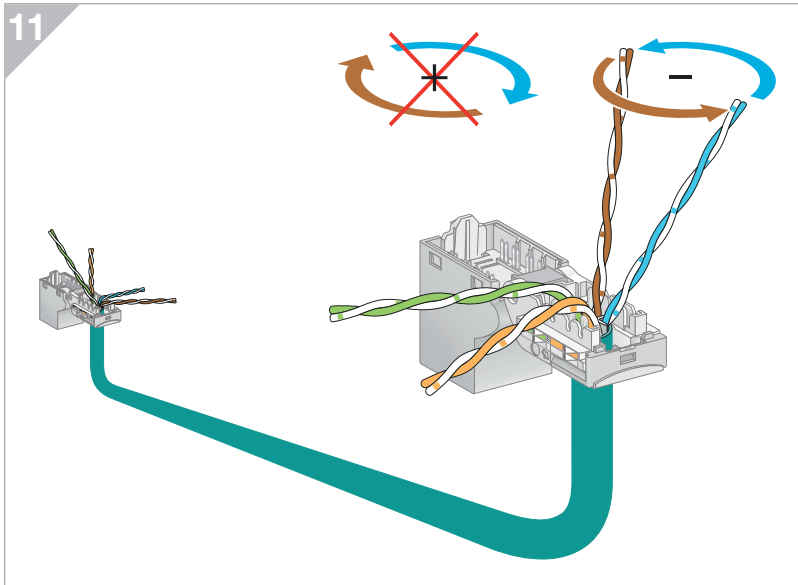
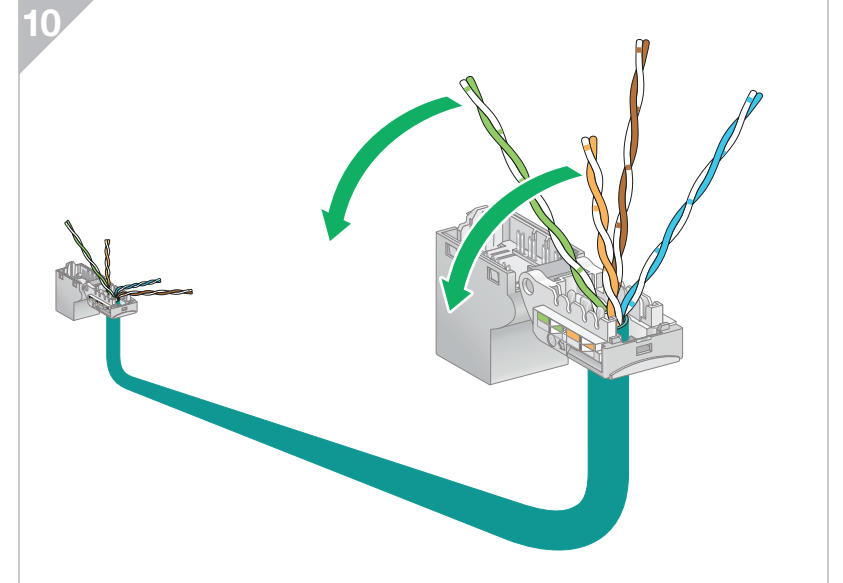
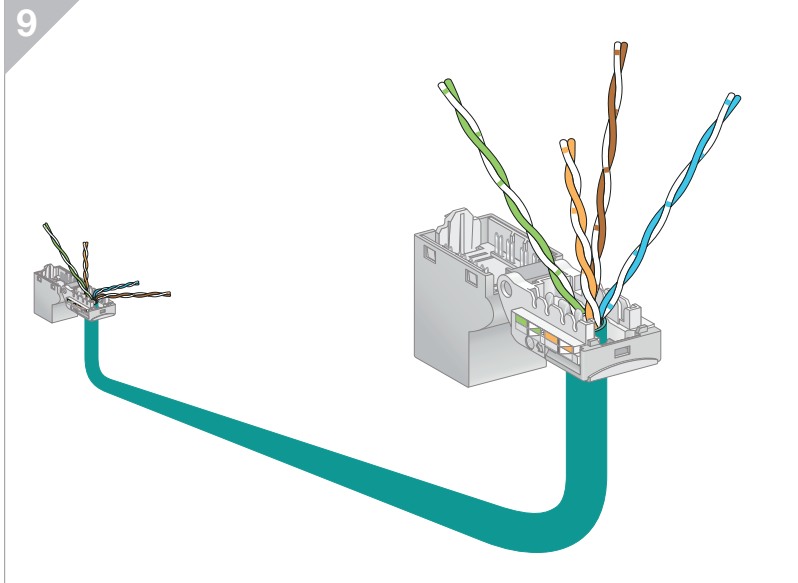
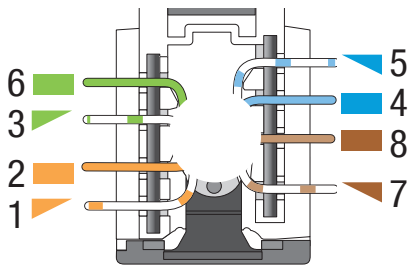

B

Convention A

How to prepare a **U/UTP** cable with The norm **EIA-TIA 568A** to reach **high performance** ?

EIA-TIA 568A (100Ω)

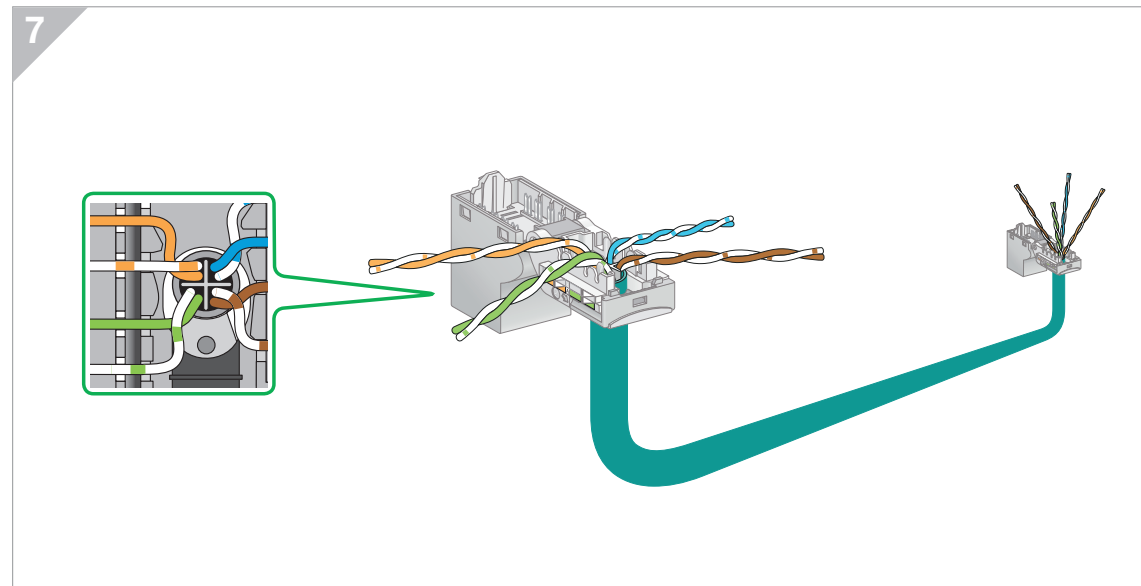
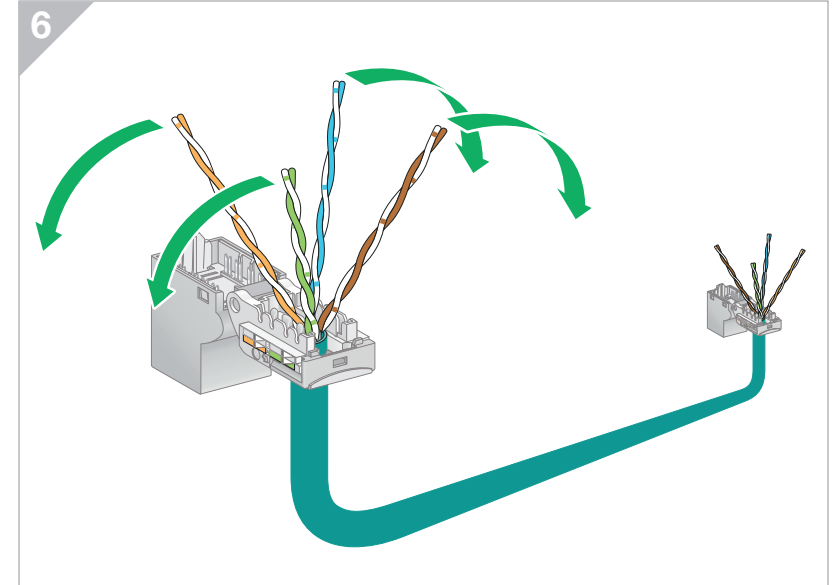
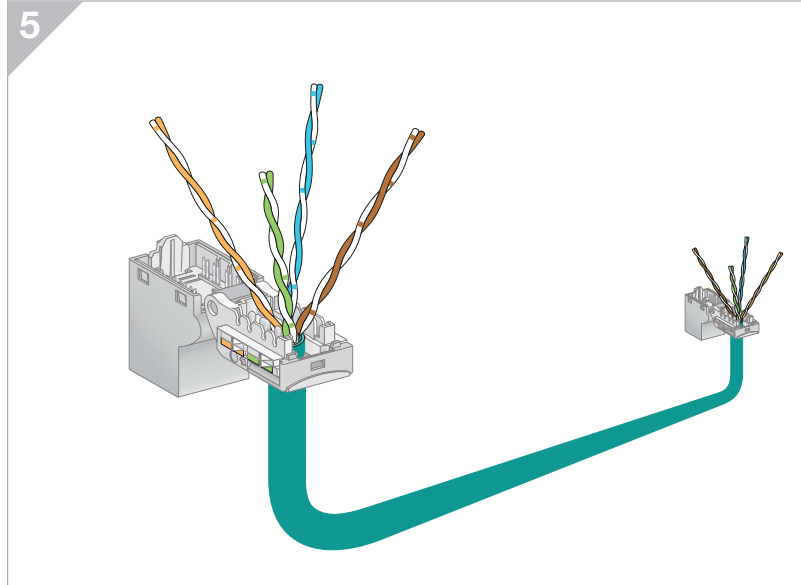
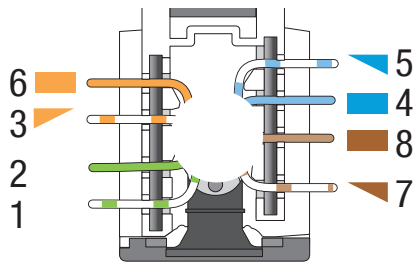

B

Convention A

How to prepare a **U/UTP** cable with The norm **EIA-TIA 568A** to reach **high performance** ?

EIA-TIA 568A (100Ω)

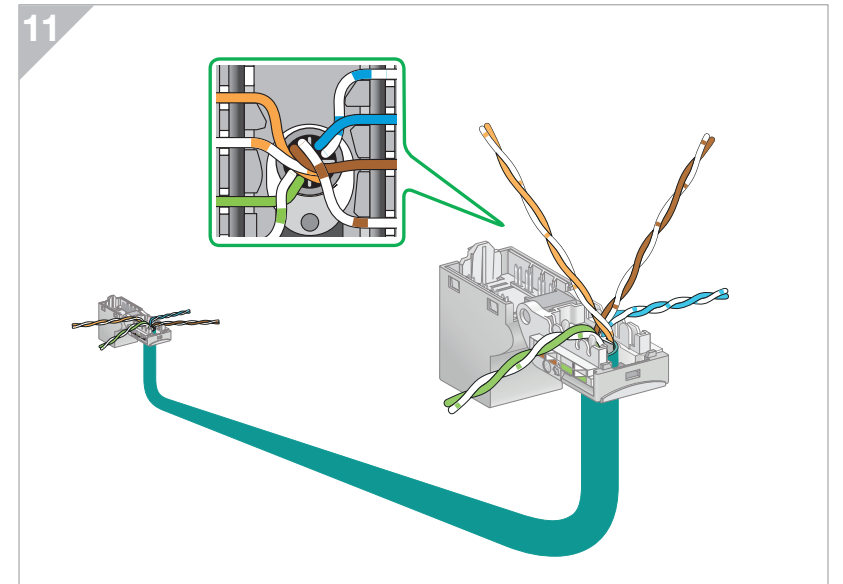
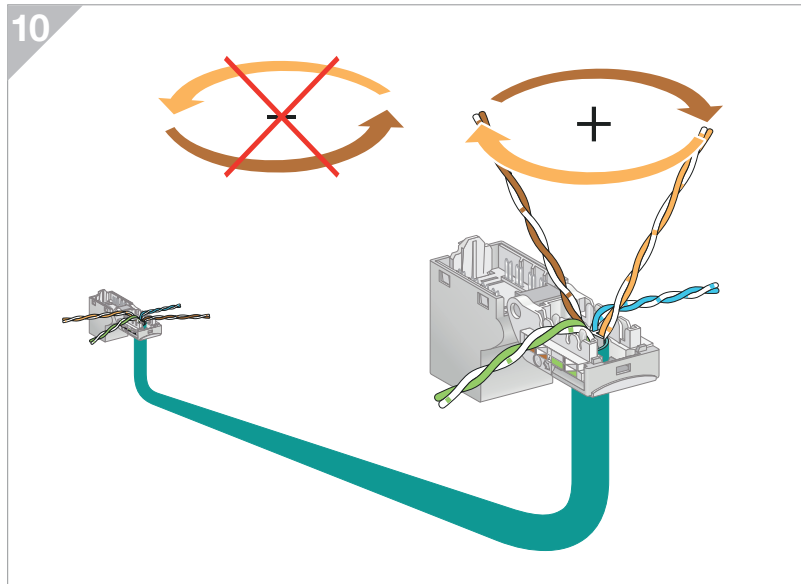
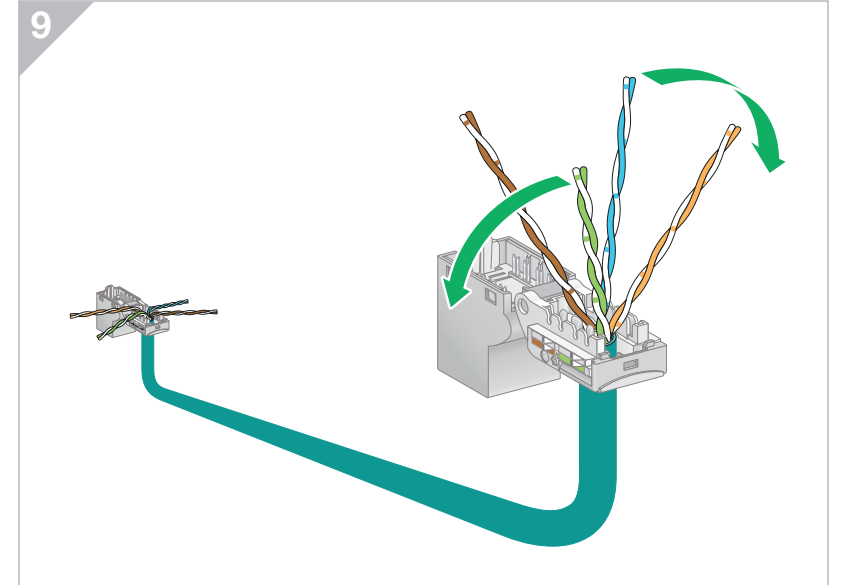
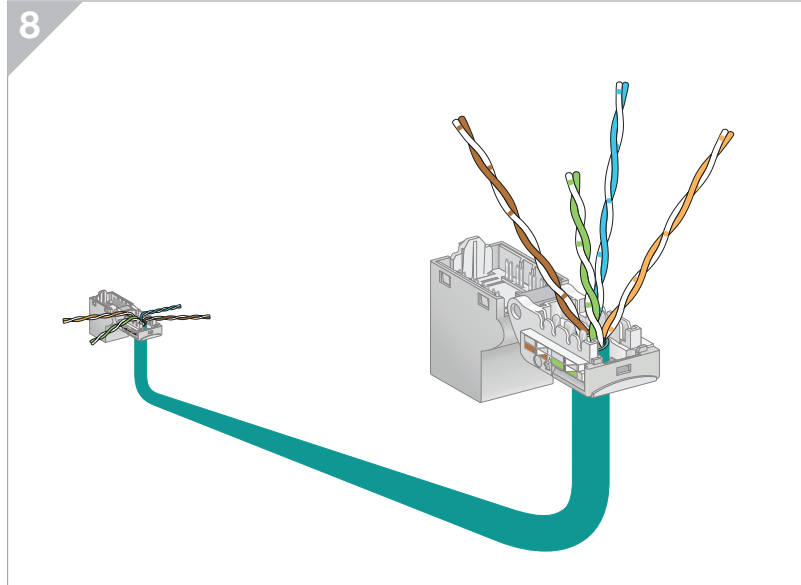
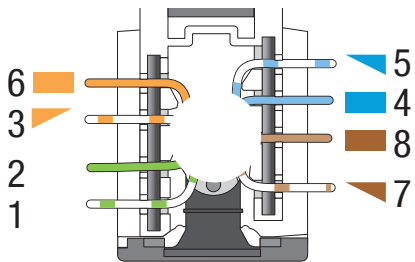

C

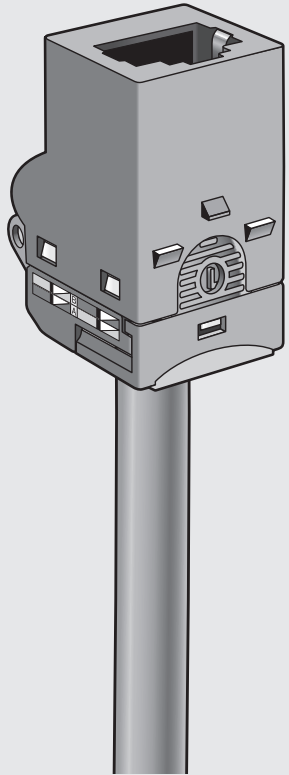

Cat 5e



Cat 6

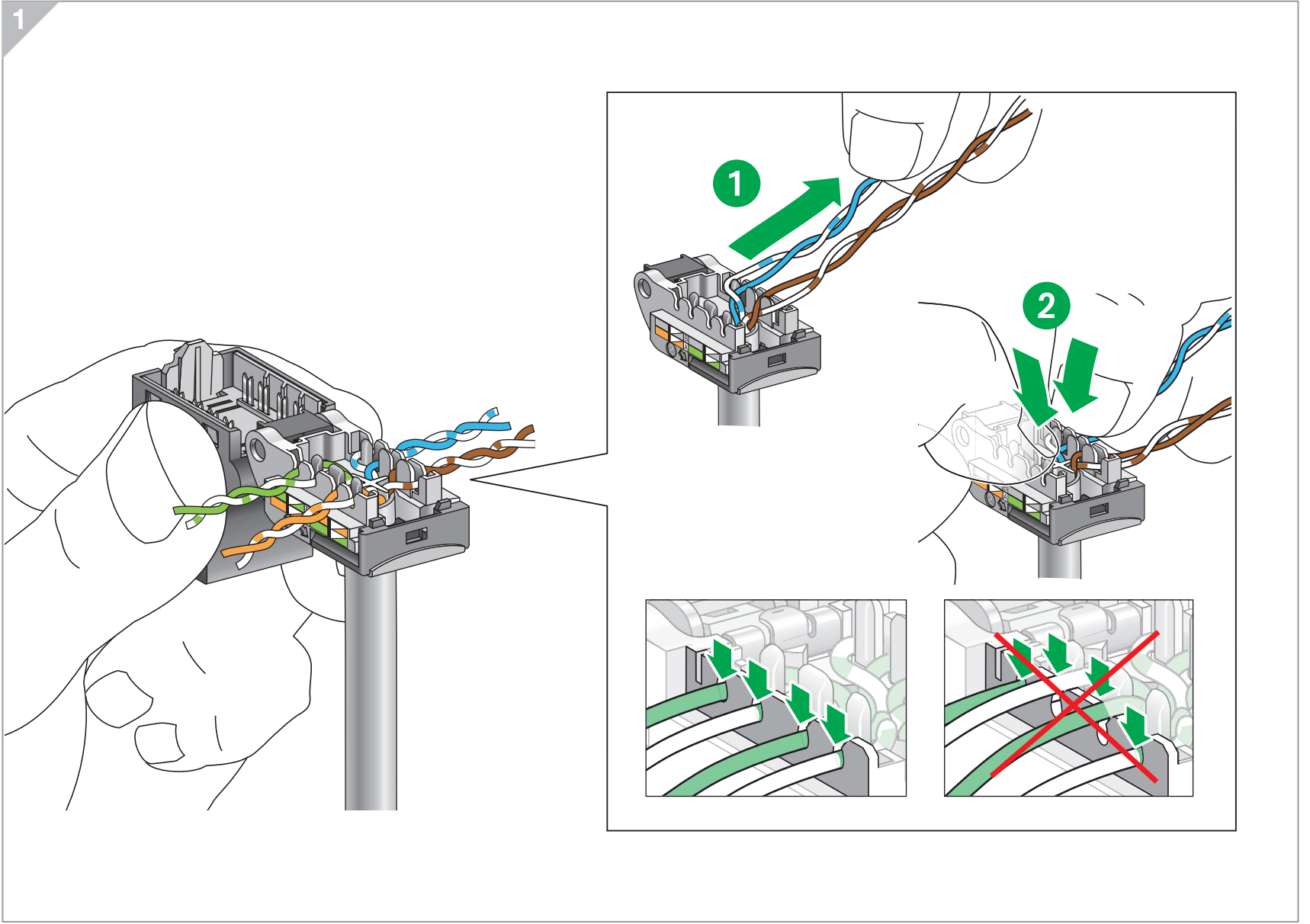
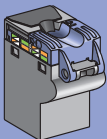

C

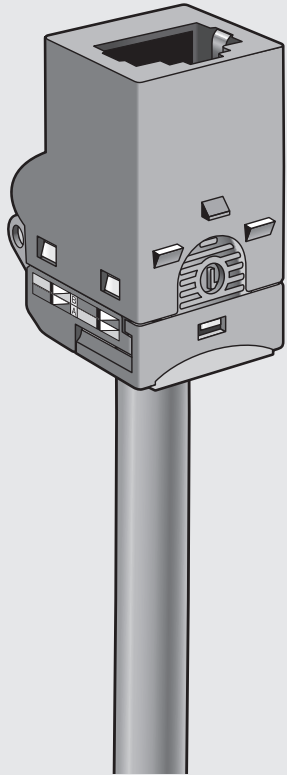

Cat 5e



Cat 6

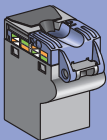

2

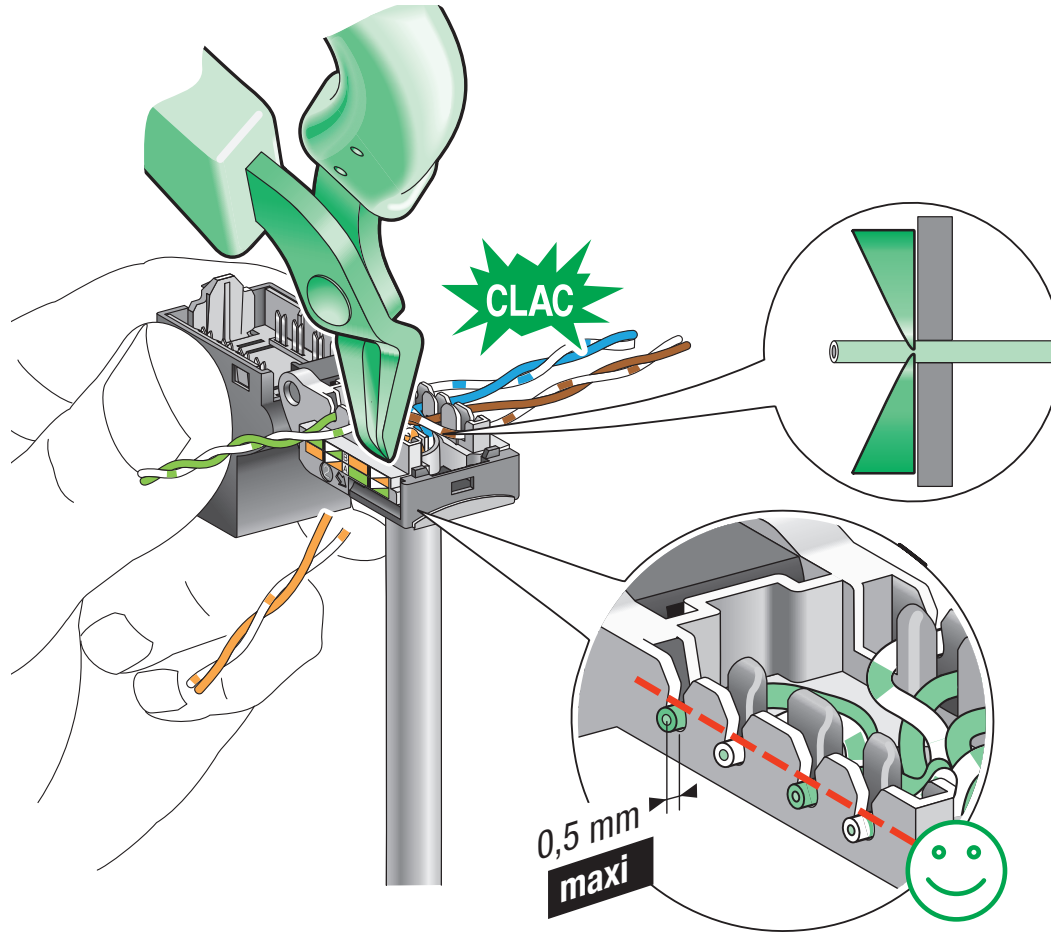

3

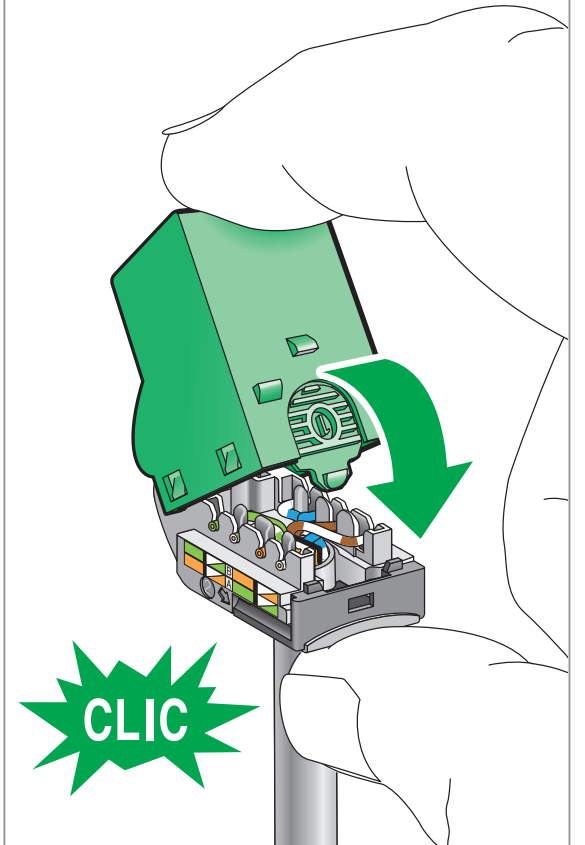

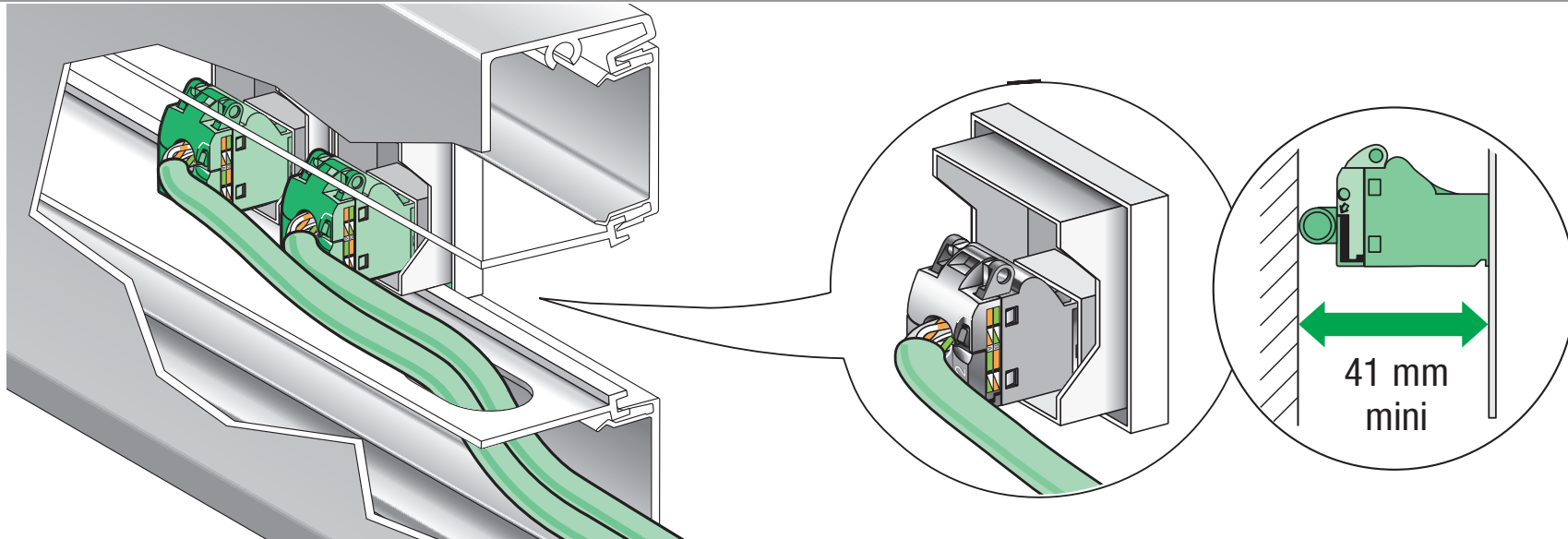
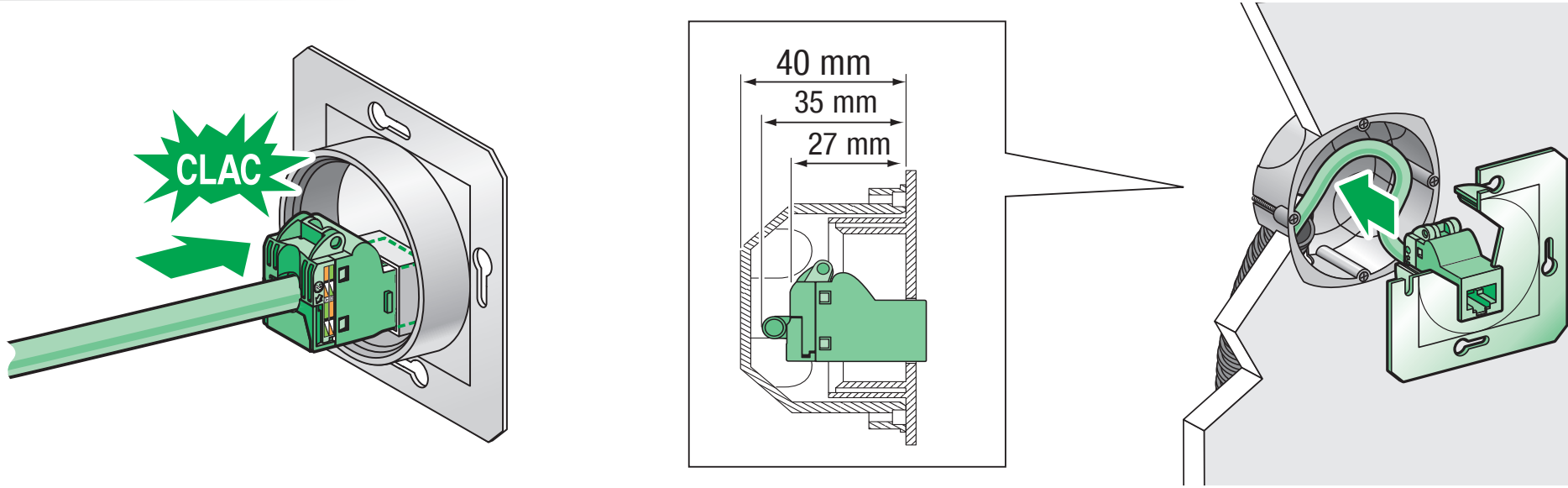

D

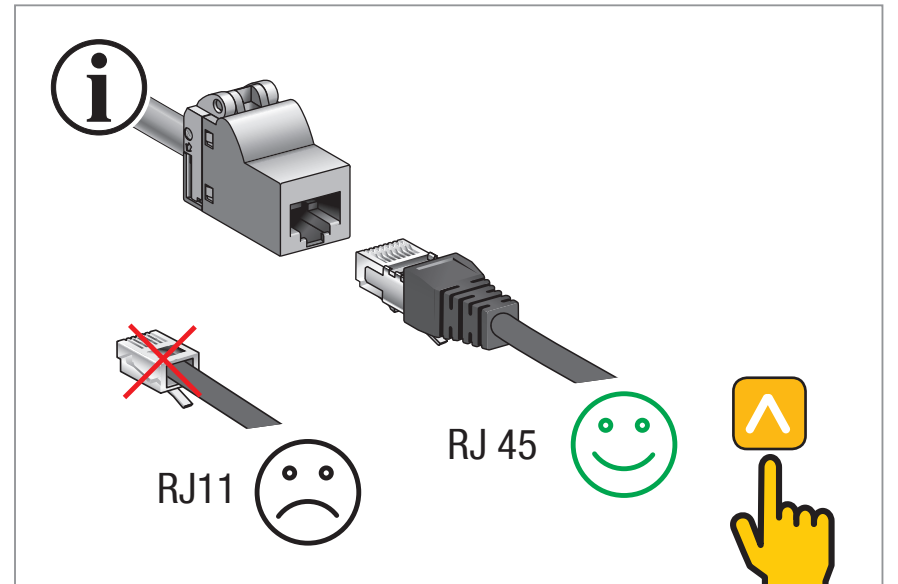
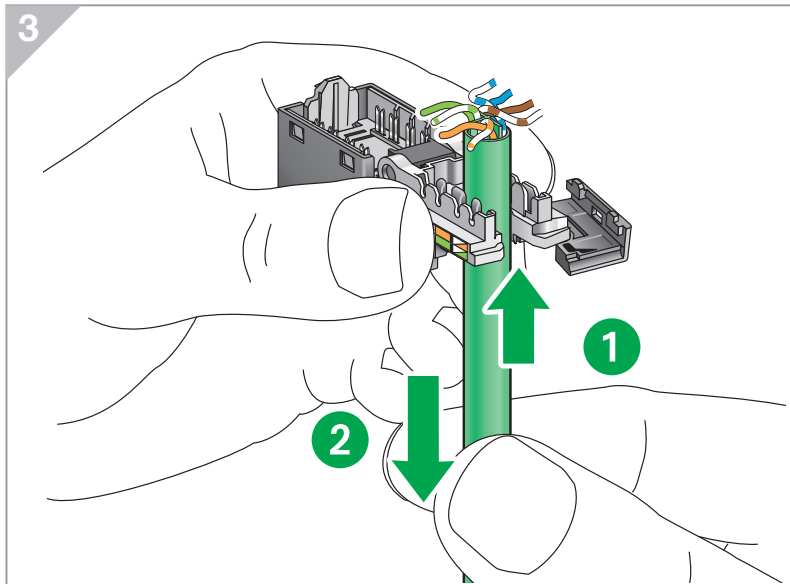
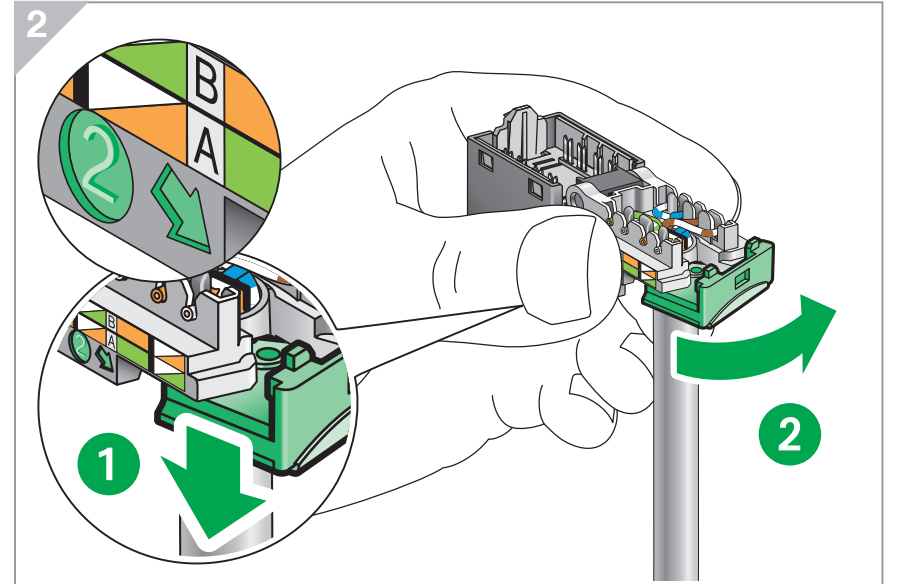
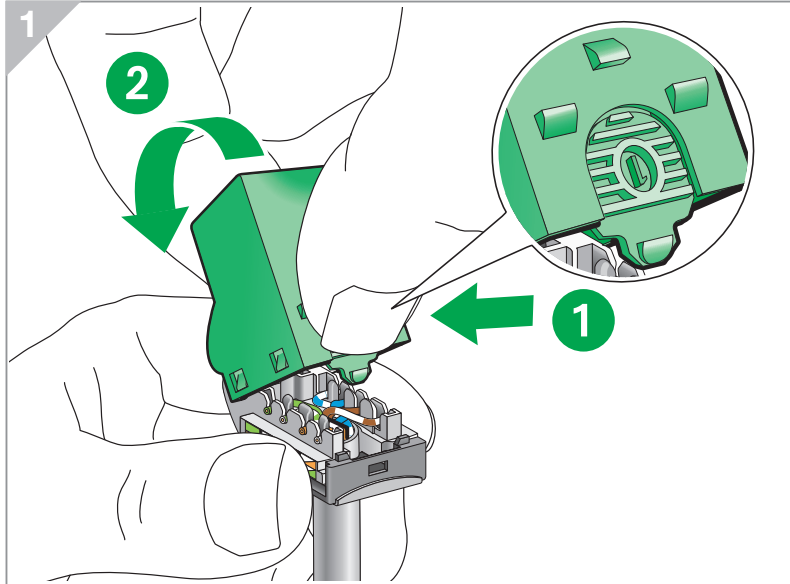
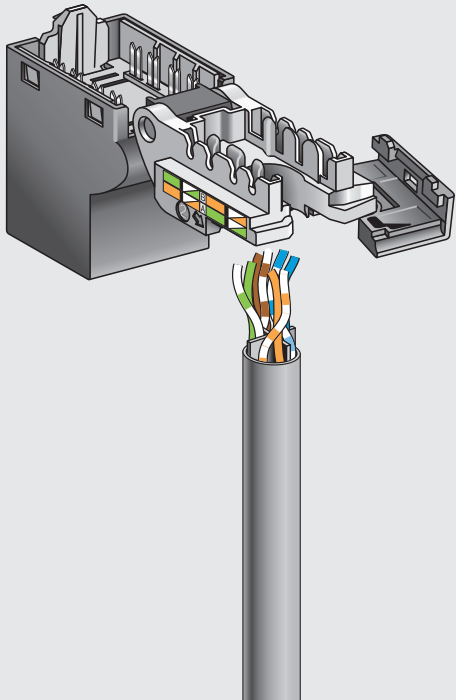

ActassiS-One Unshielded

Actassi S-One Unshielded Cat 6_A

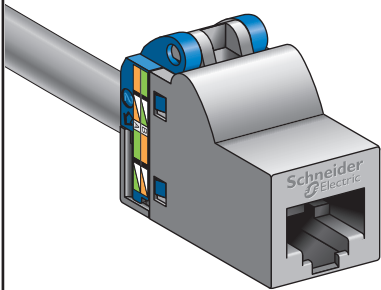

U/UTP

Cat 6A
Ø 7 mm

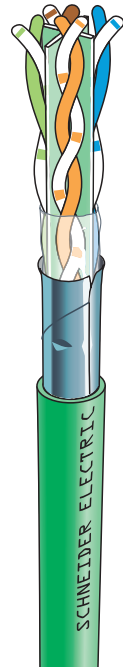

VDIR580020

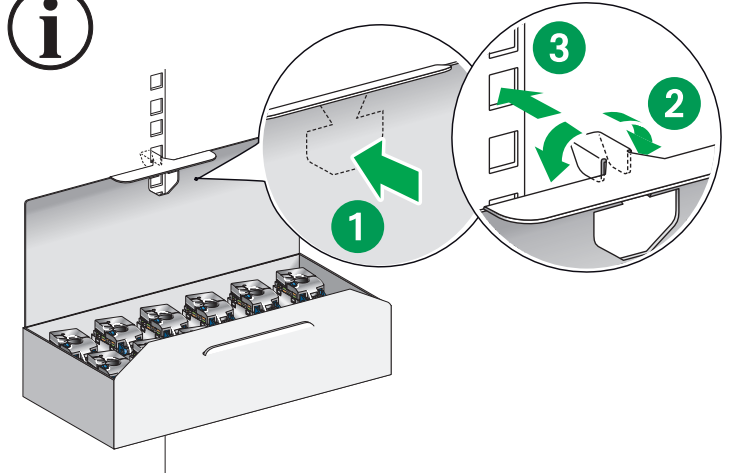
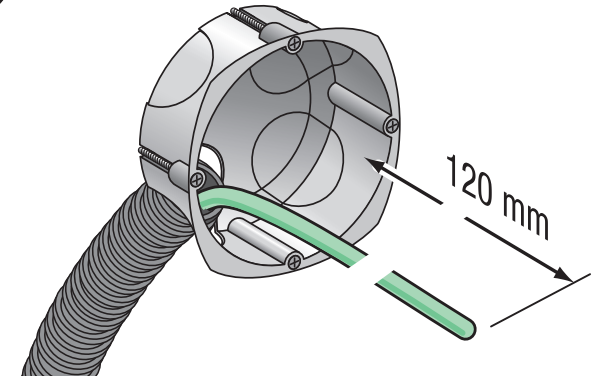

A

Cat 6A
Ø 7 mm

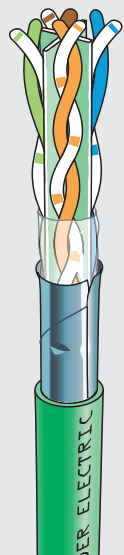

U/UTP
Class c

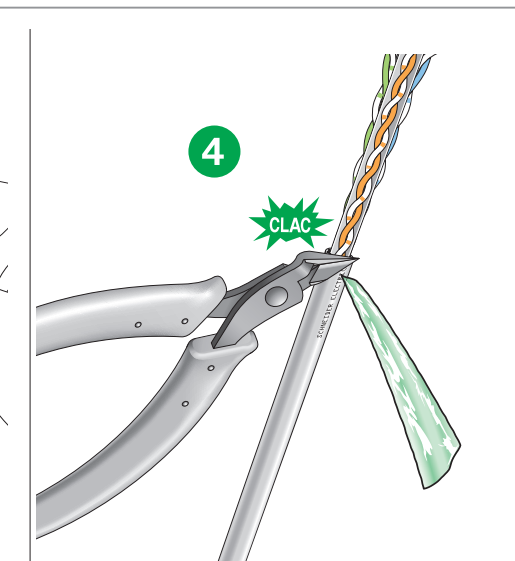
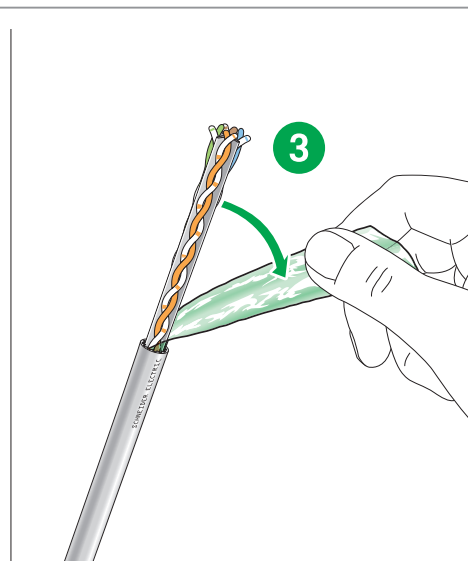
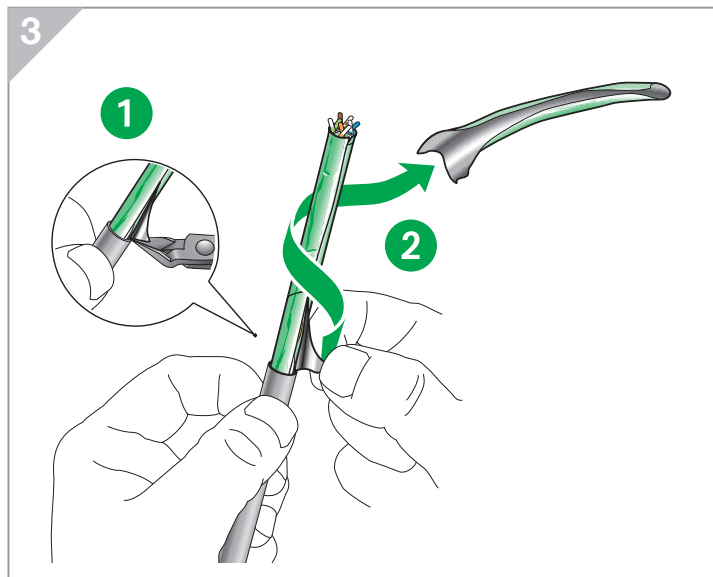
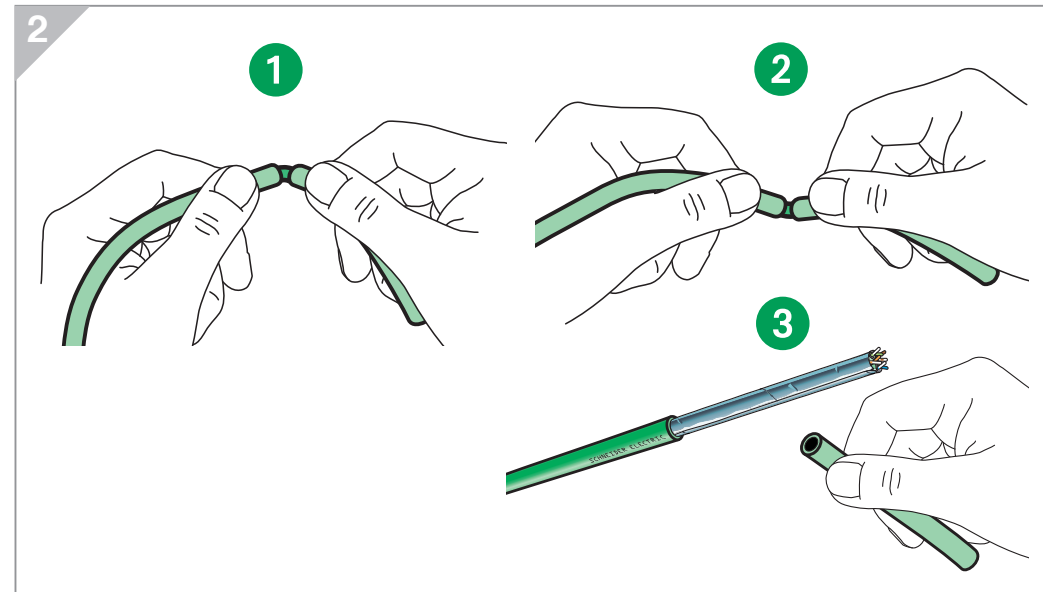
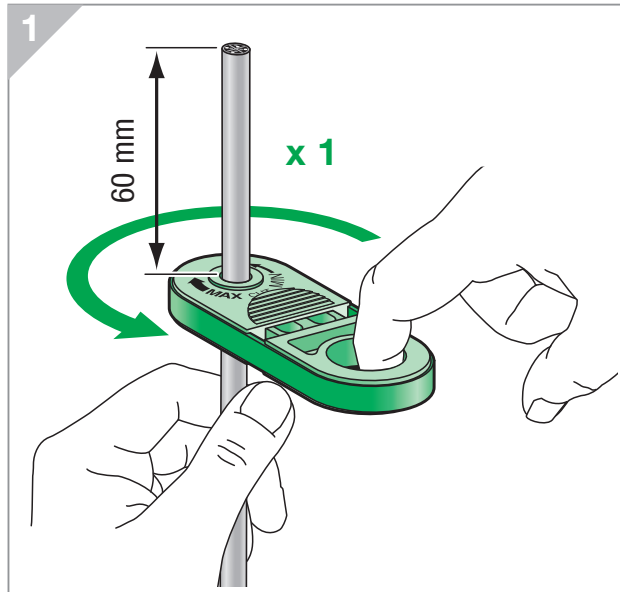
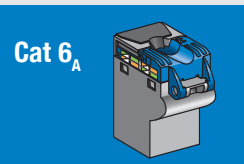

A

Cat 6A

Ø 7 mm

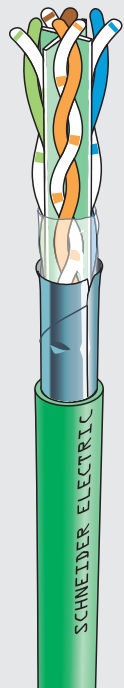

Cat 6_A

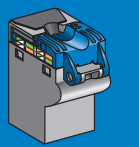

4

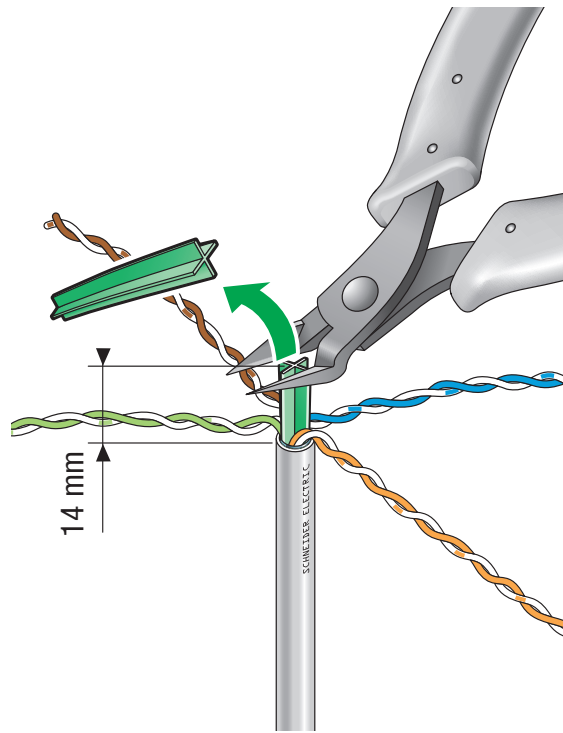
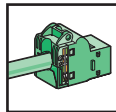

Ø 7 mm

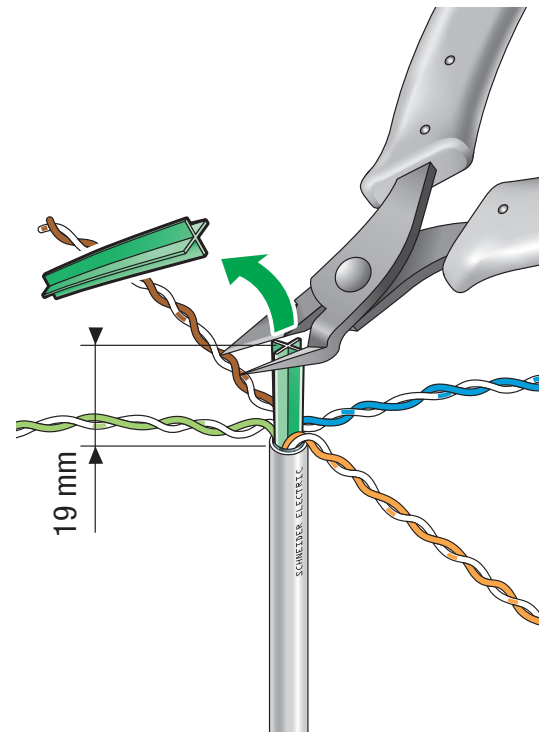
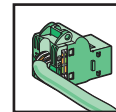

Ø 7 mm

5

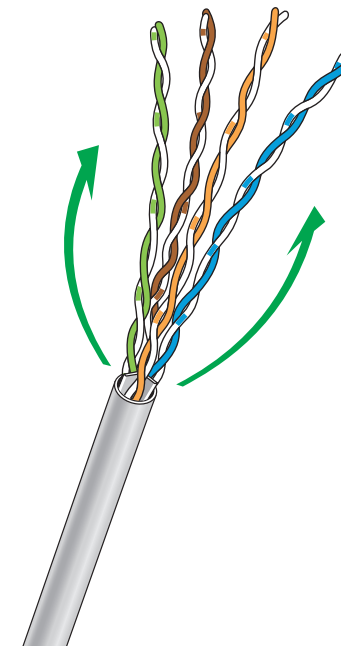

B

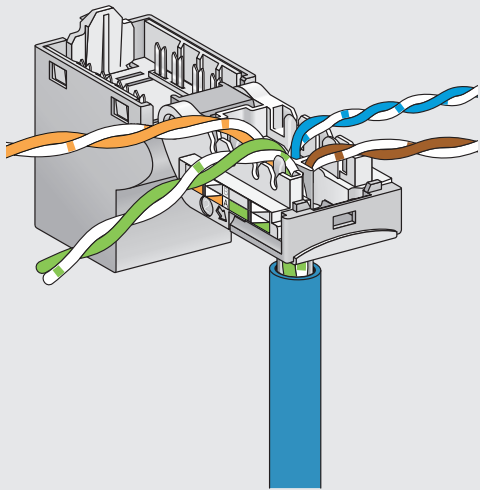

Cat 6_A

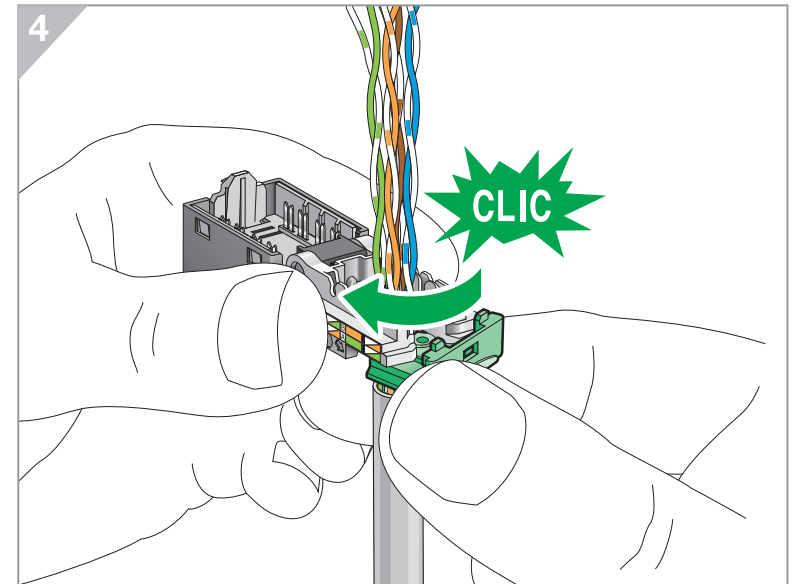
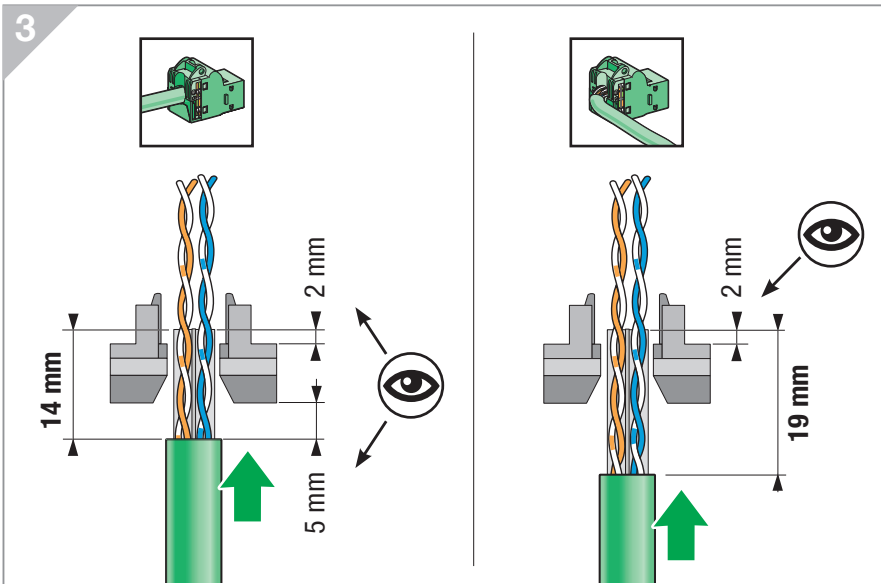
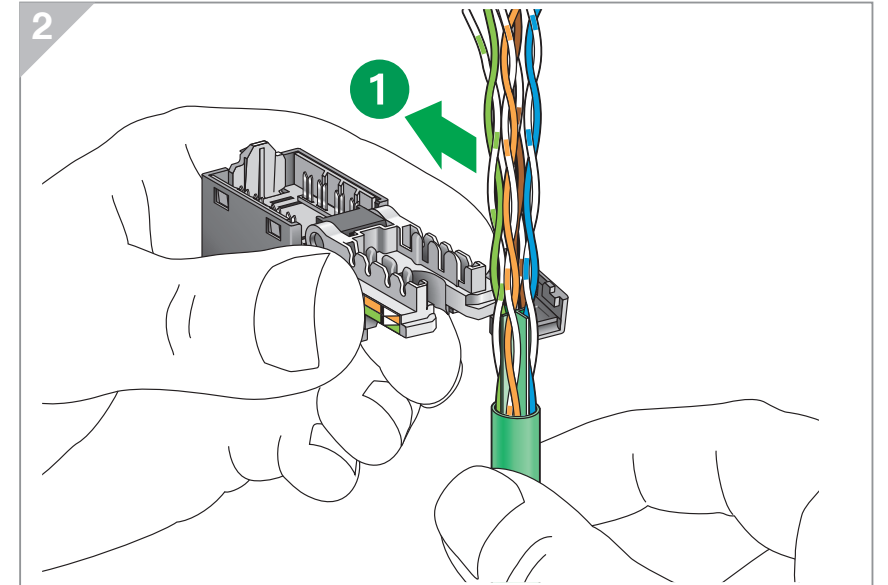
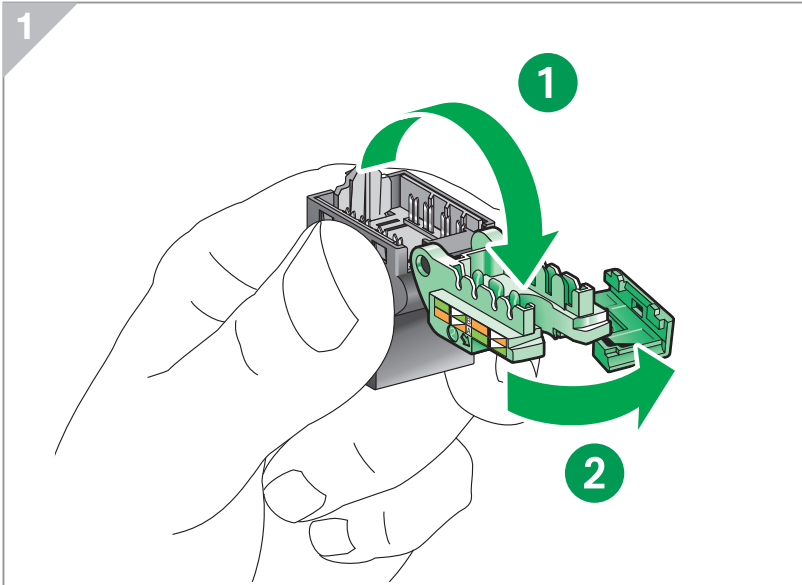
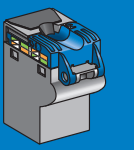

B

Convention B

How to prepare a **U/UTP** cable with The norm **EIA-TIA 568B** to reach **performance** ?



EIA-TIA 568B (100Ω)

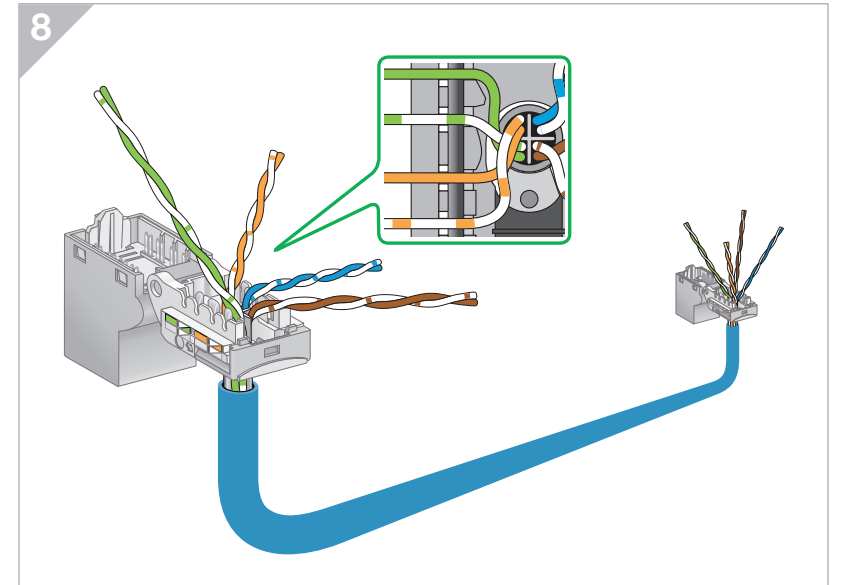
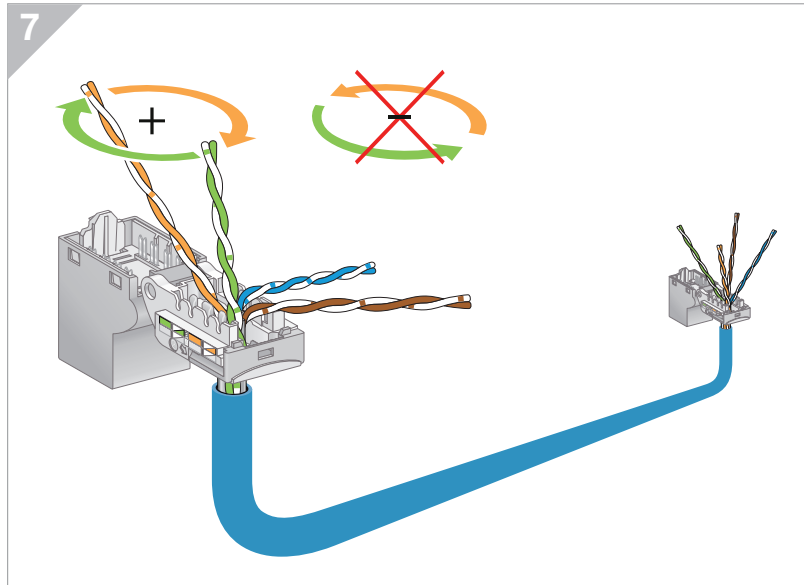
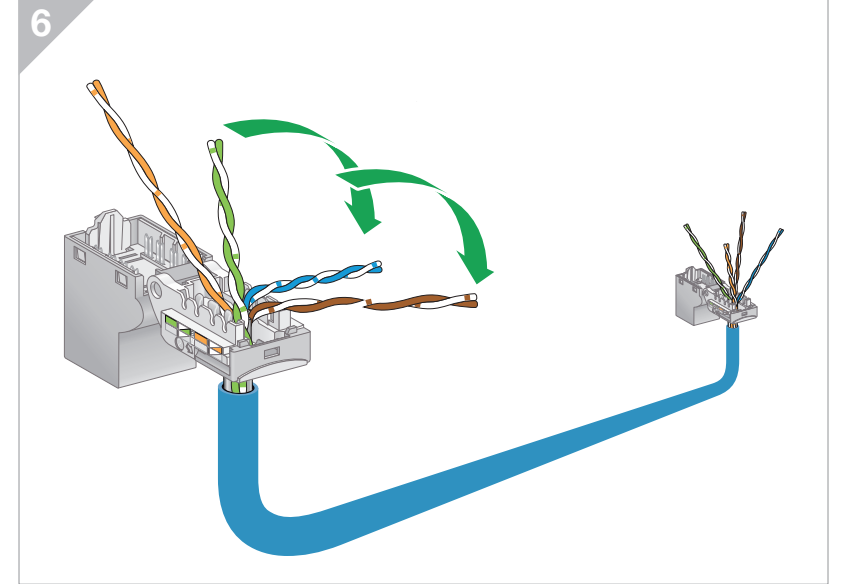
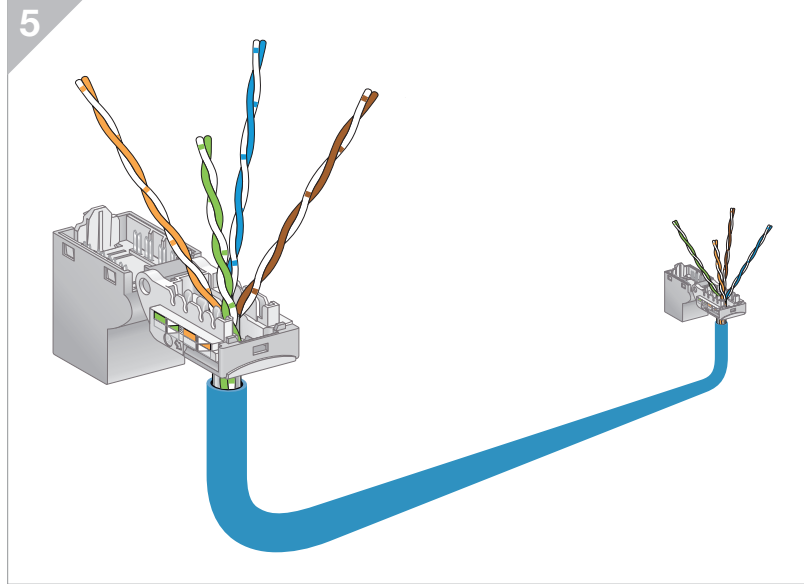
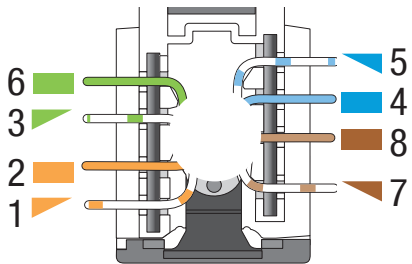

B

Convention B

How to prepare a **U/UTP** cable with The norm **EIA-TIA 568B** to reach **performance** ?

EIA-TIA 568B (100Ω)

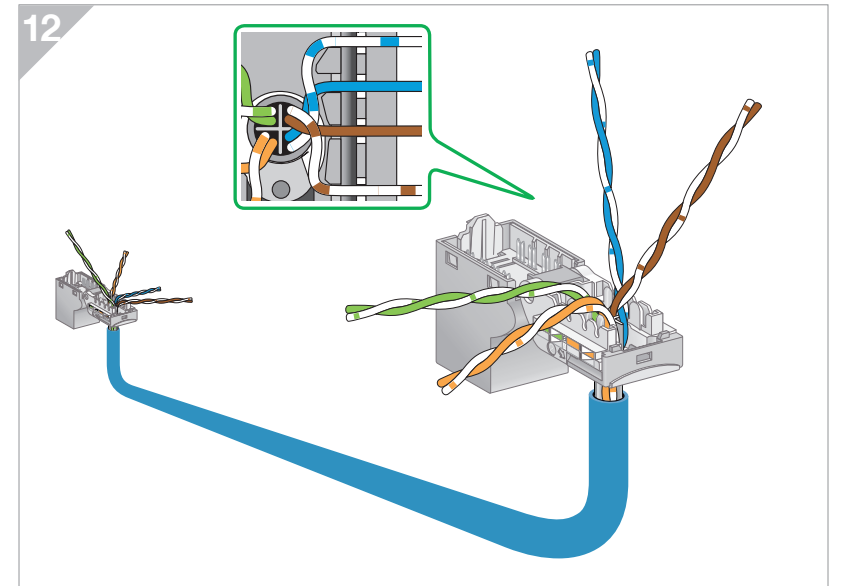
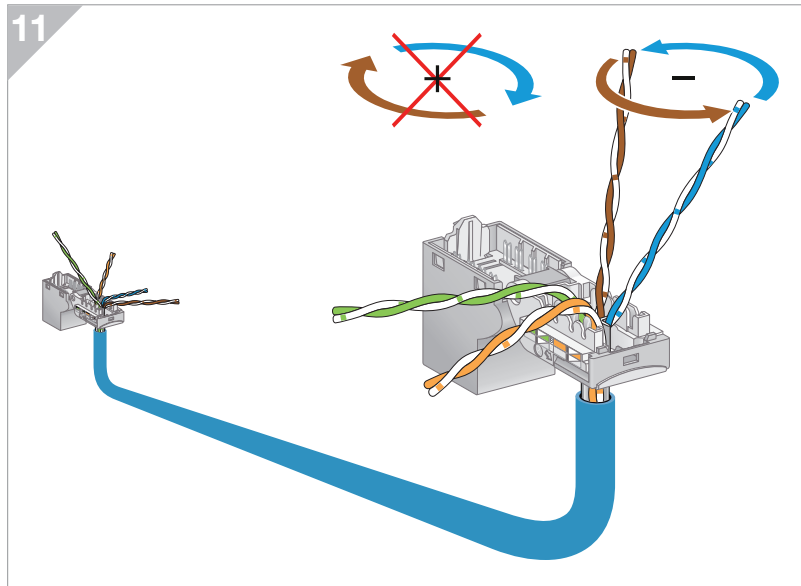
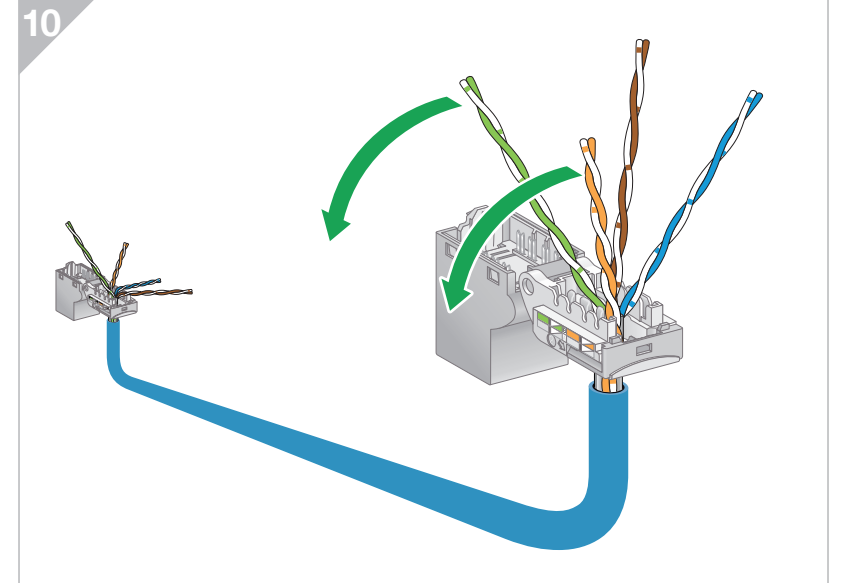
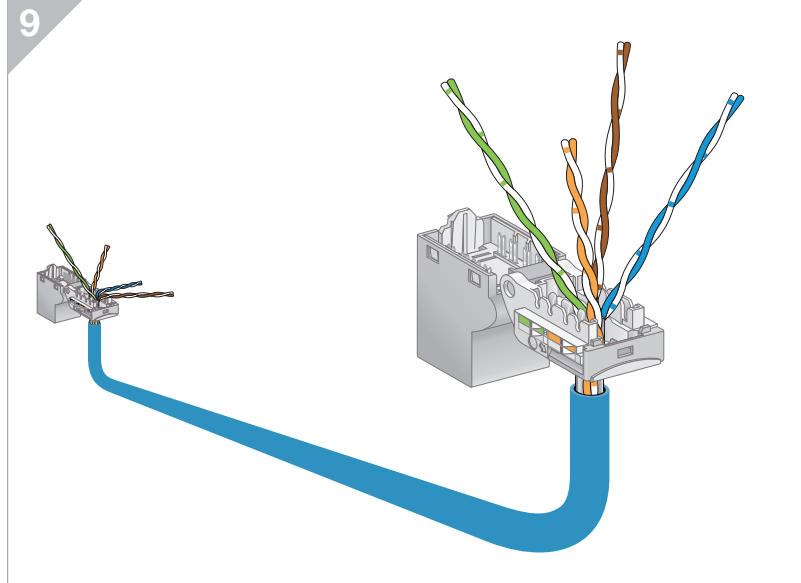
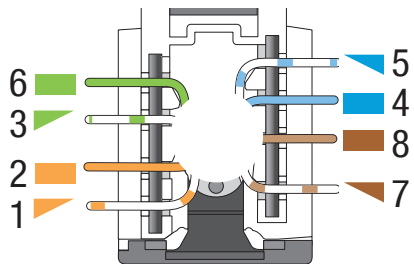

B Convention A

How to prepare a **U/UTP** cable with The norm **EIA-TIA 568A** to reach **performance** ?

EIA-TIA 568A (100Ω)

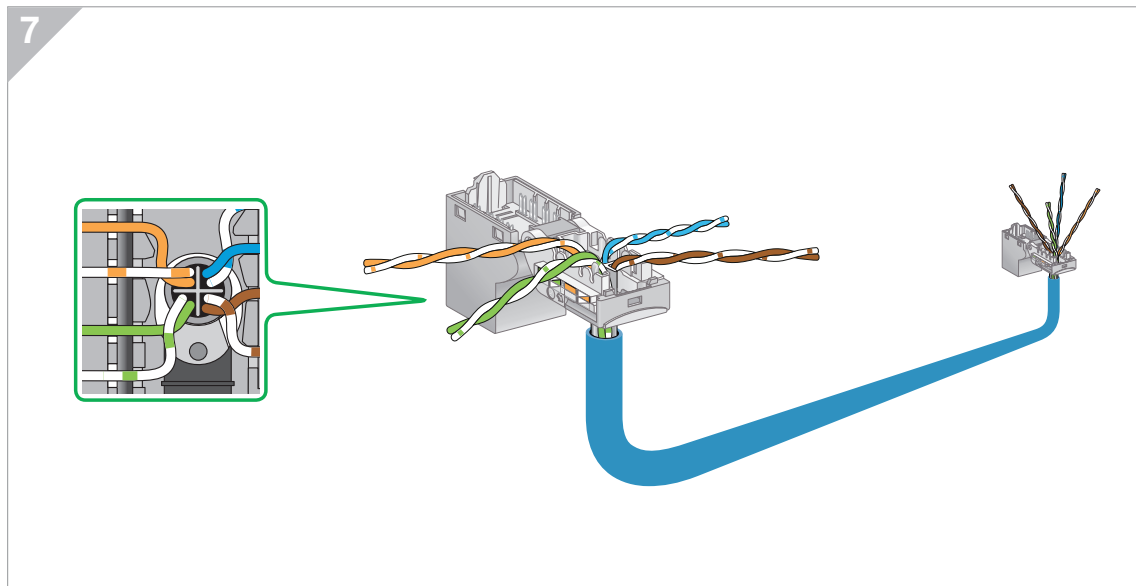
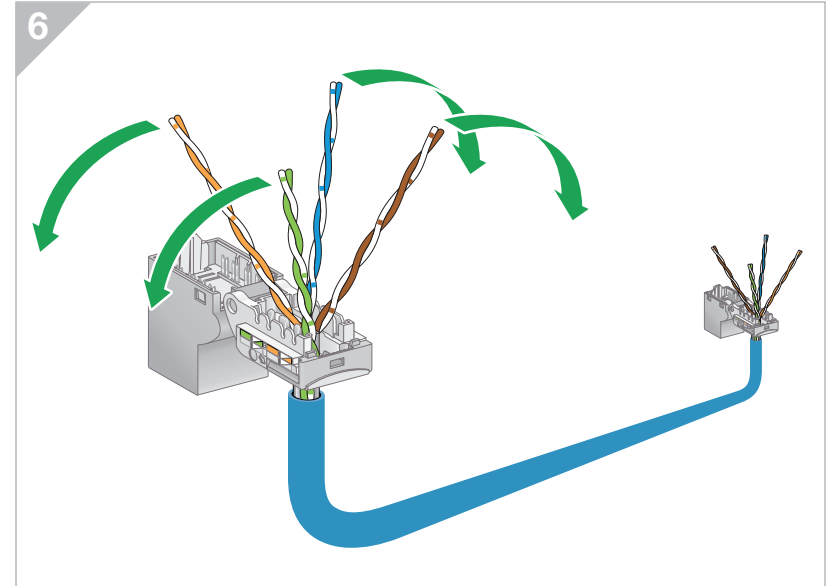
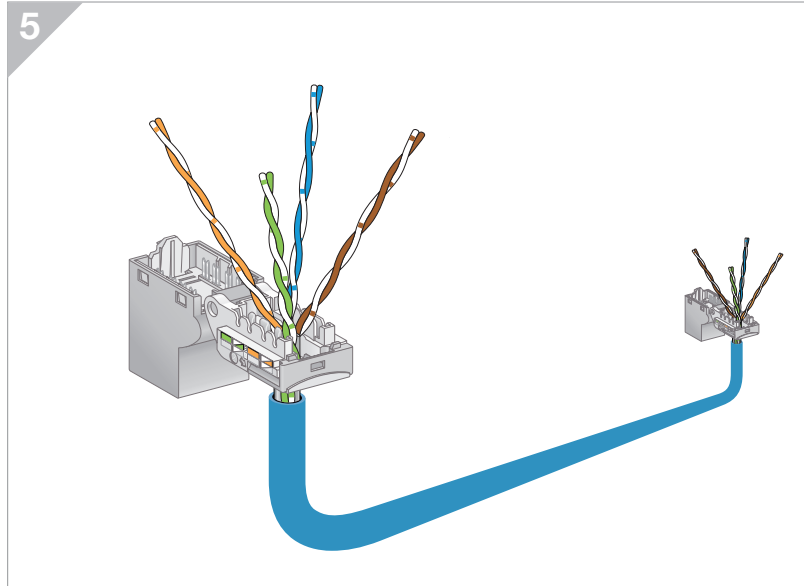
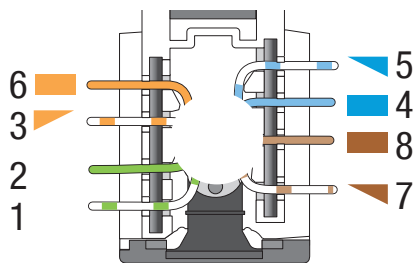

B Convention A

How to prepare a **U/UTP** cable with The norm **EIA-TIA 568A** to reach **performance** ?

EIA-TIA 568A (100Ω)

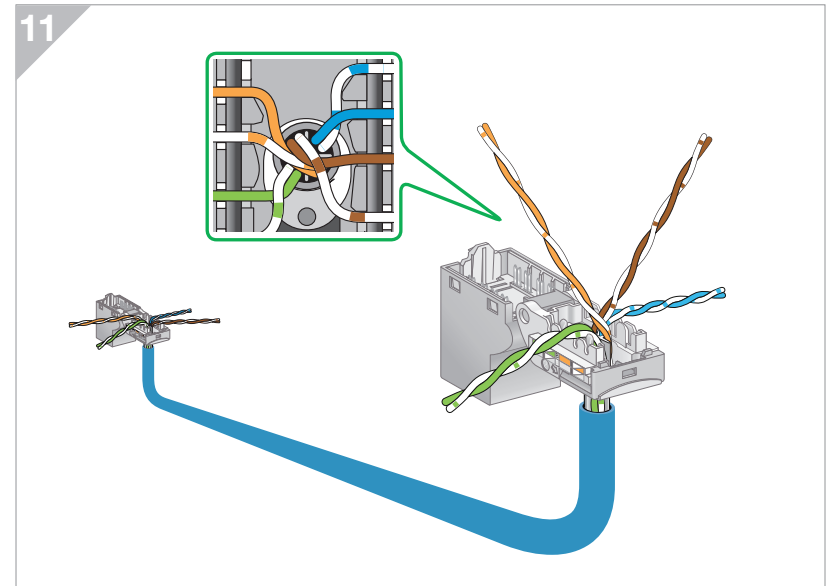
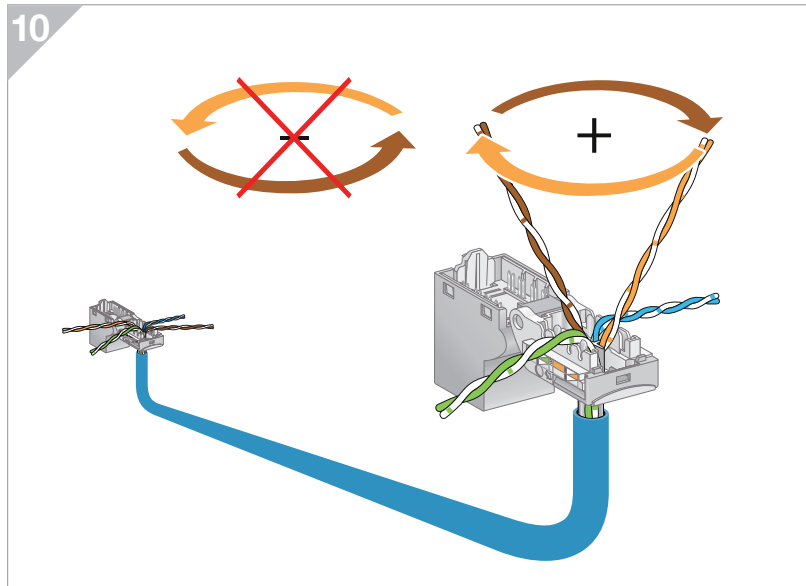
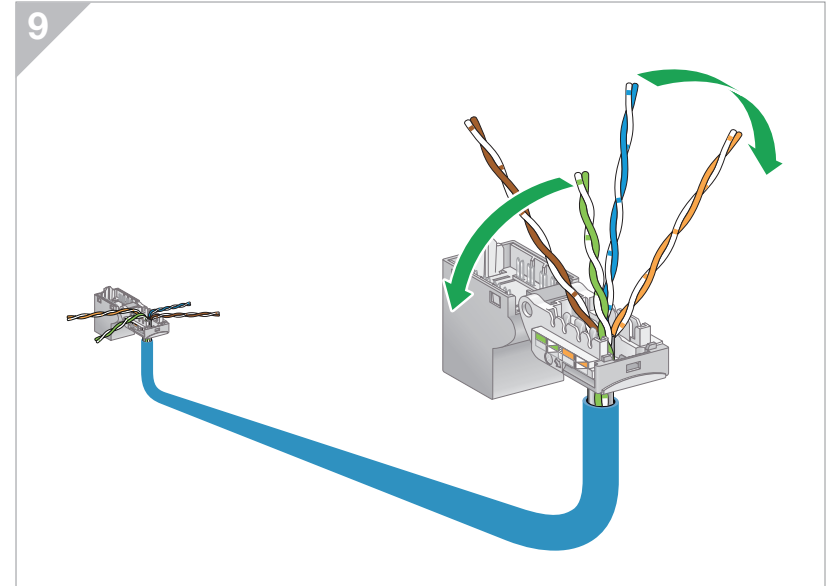
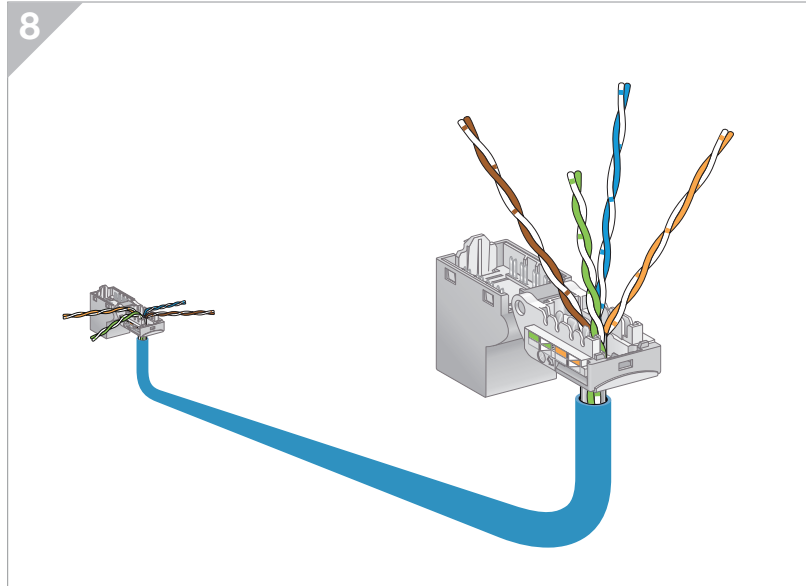
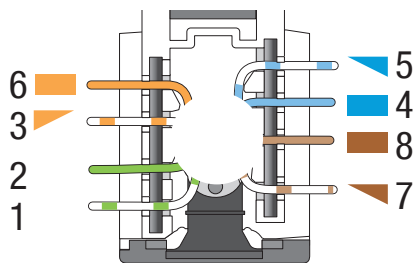

C

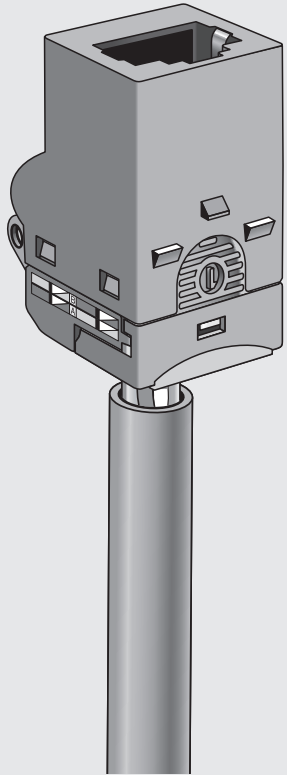

Cat 6_A



1

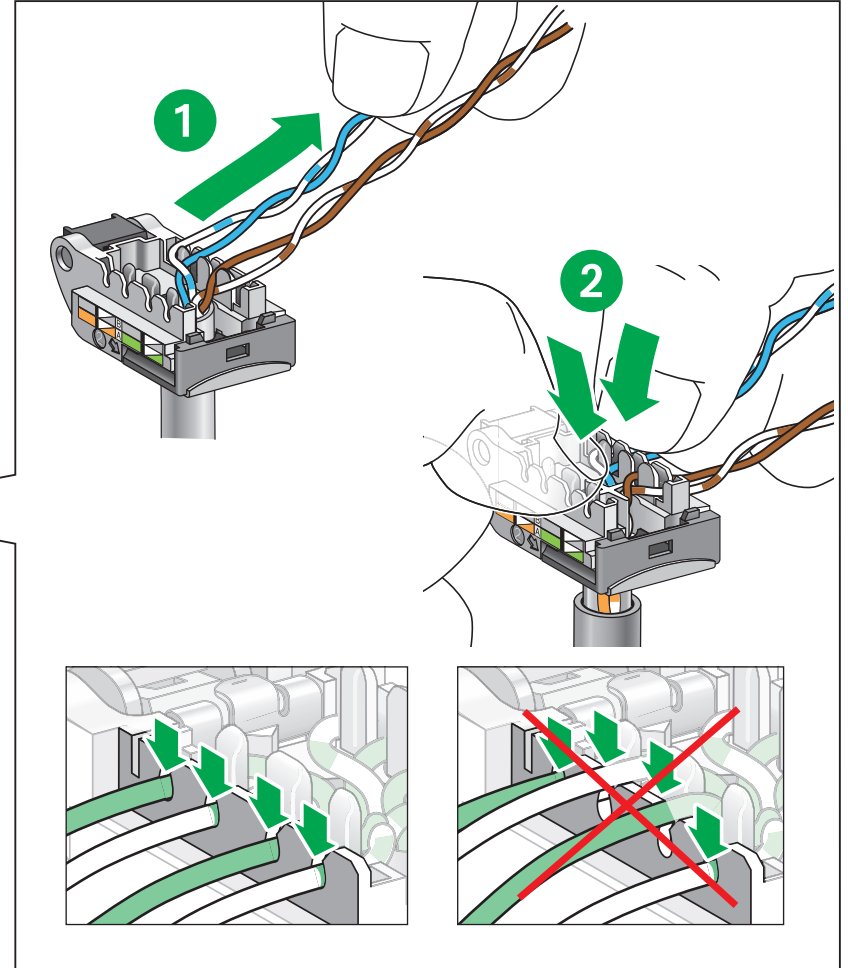
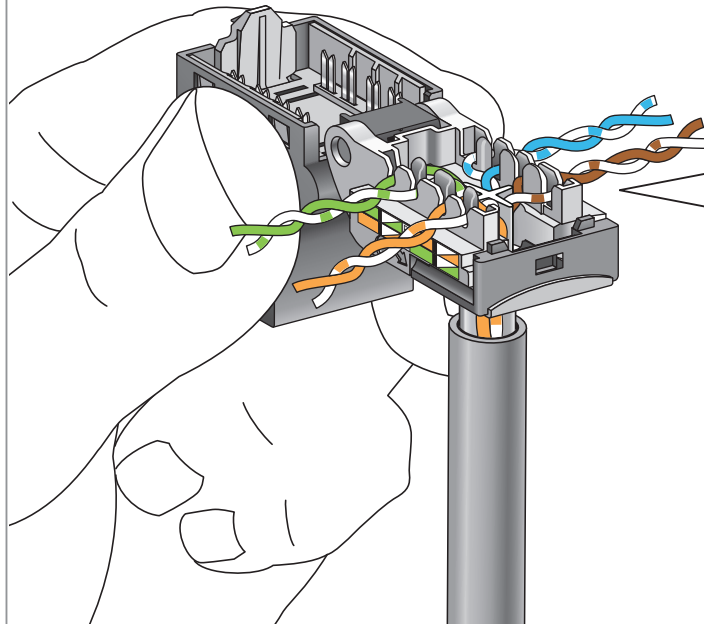

C

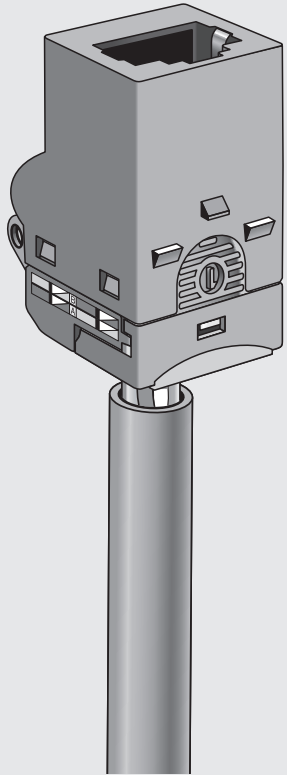

Cat 6_A

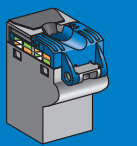

2

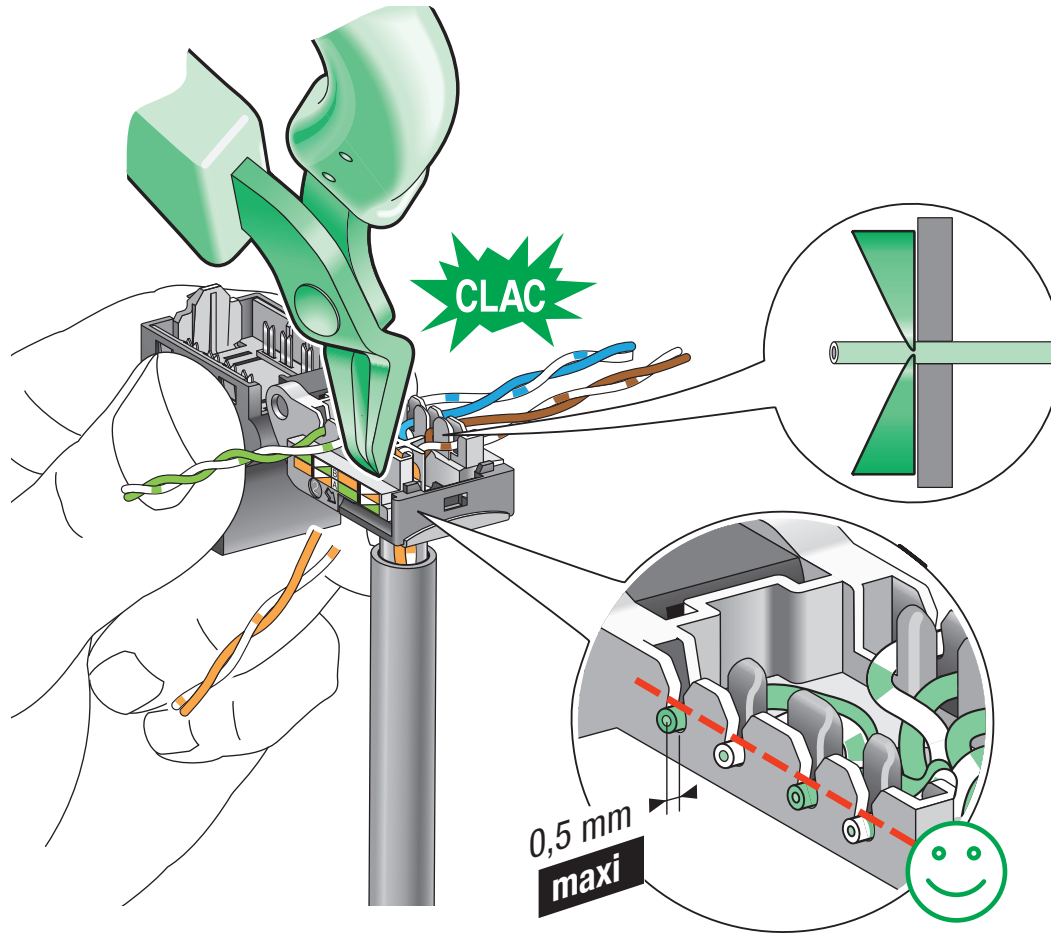

3

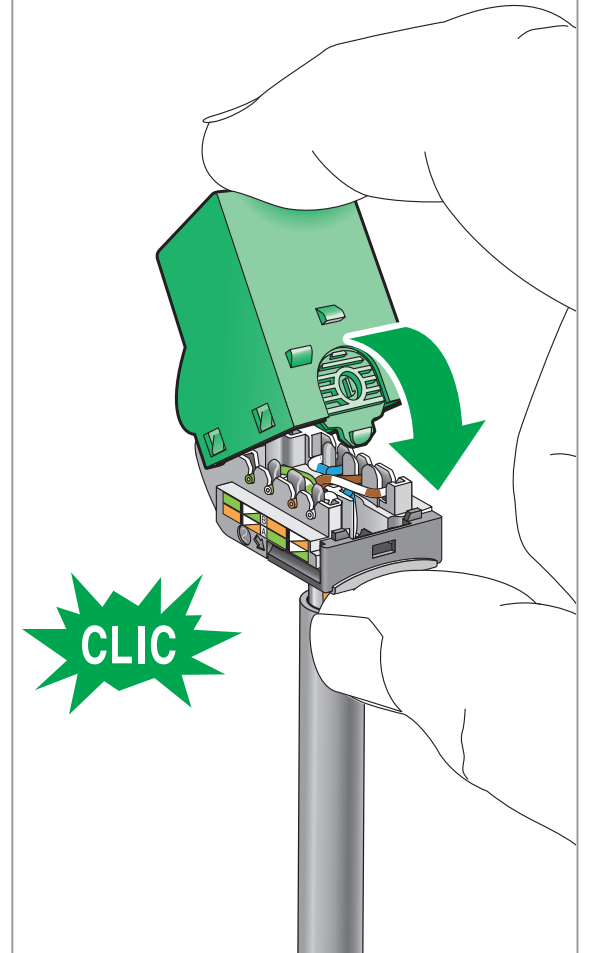

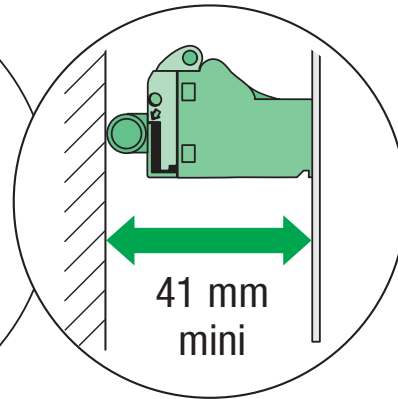
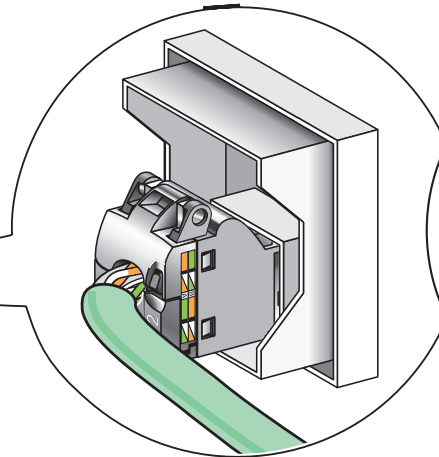
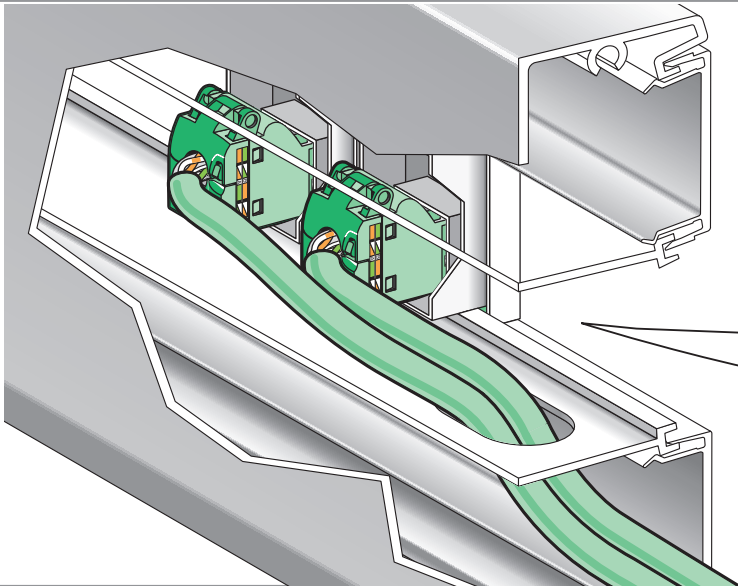
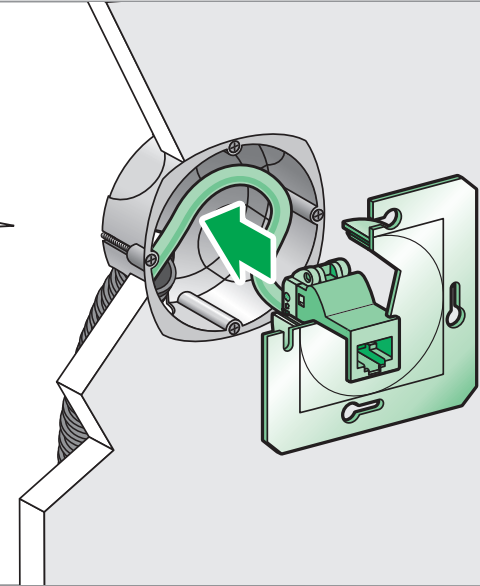
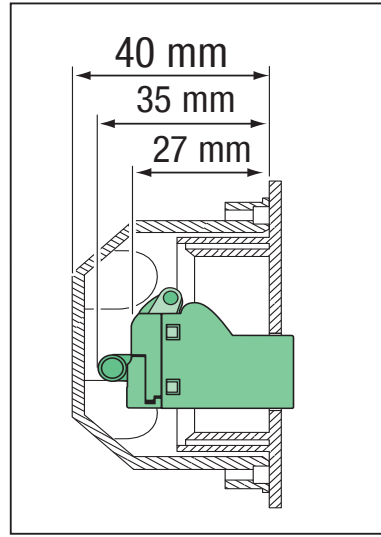
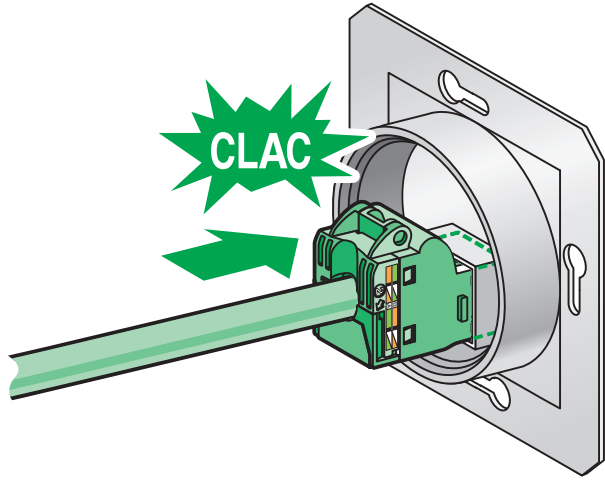

D

