

Actassi S-One Shielded

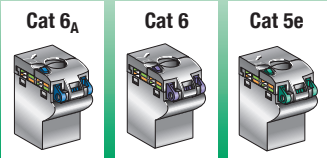

PoE+
Power over Ethernet Plus

- IEEE 802.3BT 4 pairs PoE
- IEC 60512-99-00
- IEC 60603-7
- ISO/IEC 11801
- ANSI/TIA-568-C.2

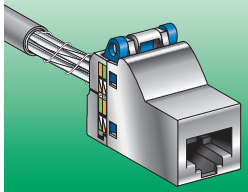
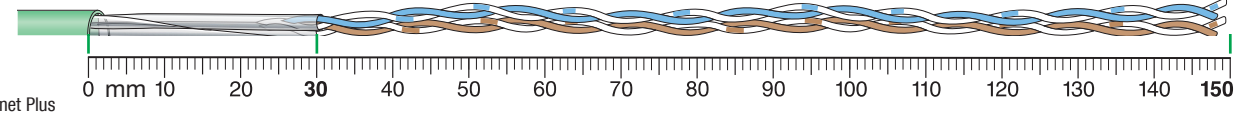

S1A5187002-06
AAK019D7002-06

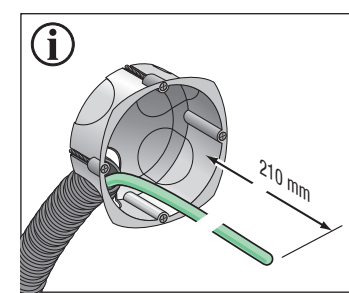
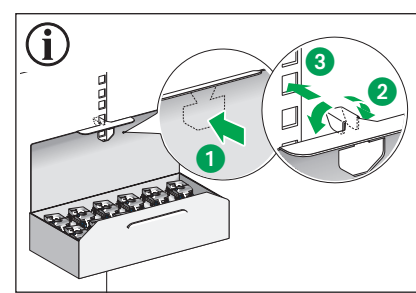
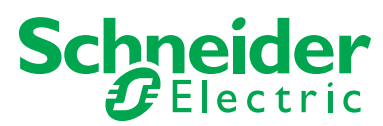

F/UTP

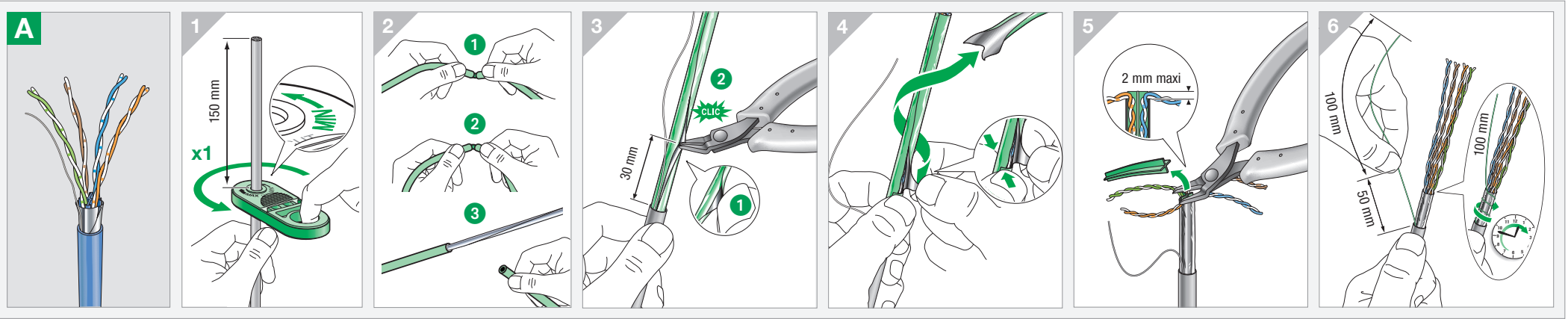

SF/UTP

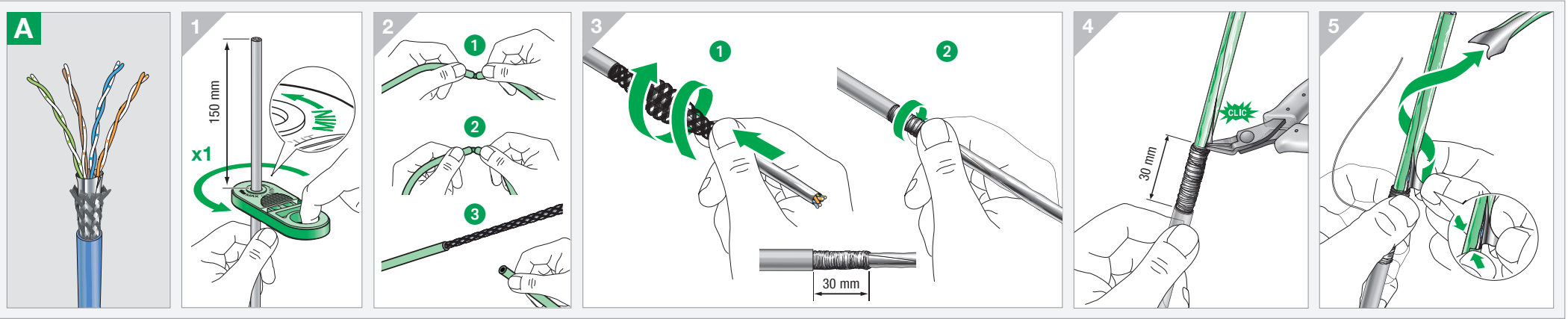

S/FTP

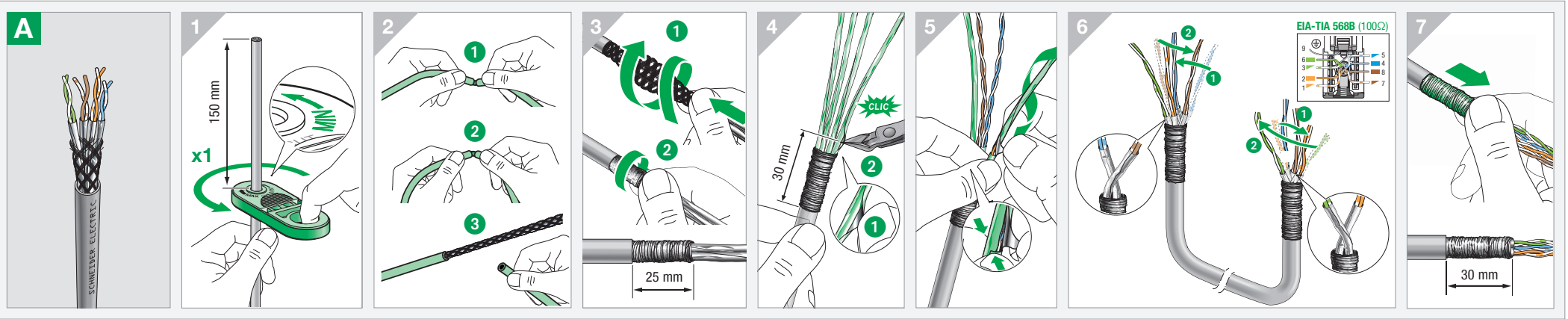

CLMX (F/FTP)

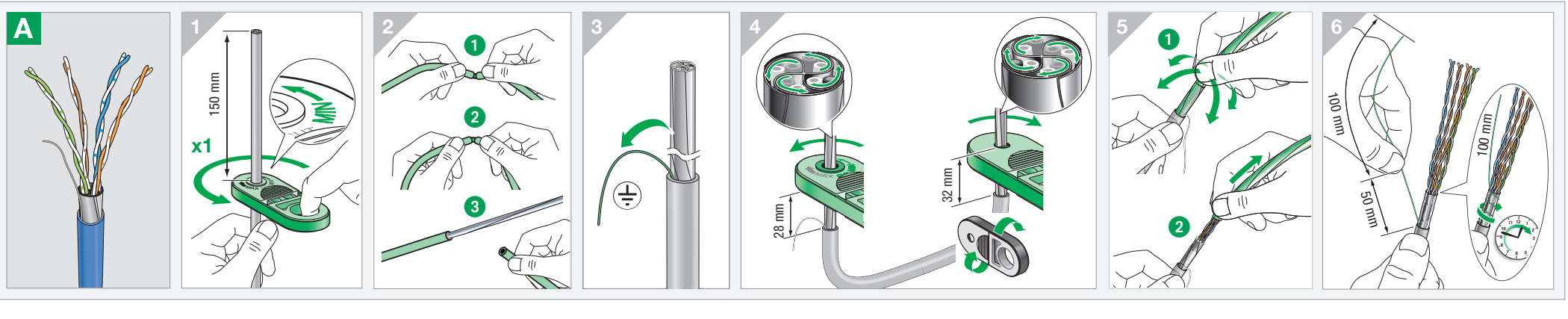

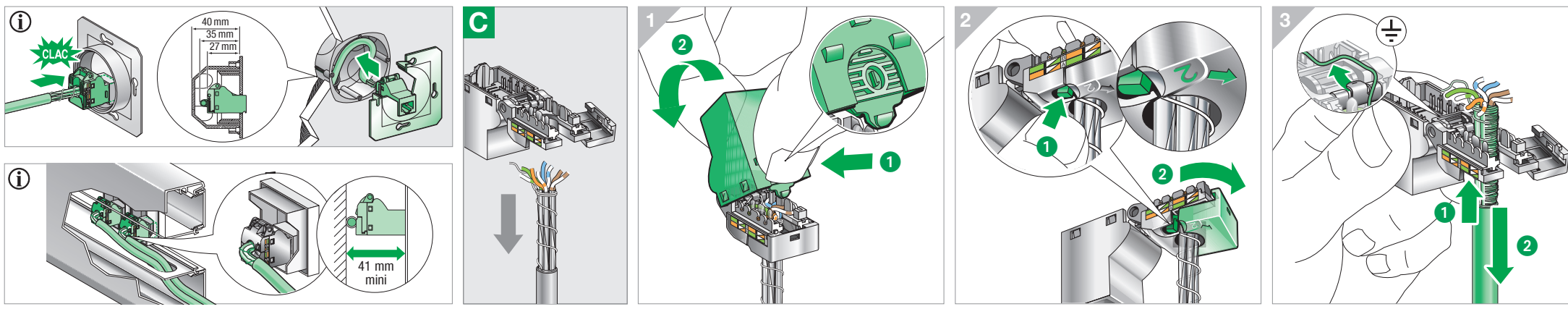
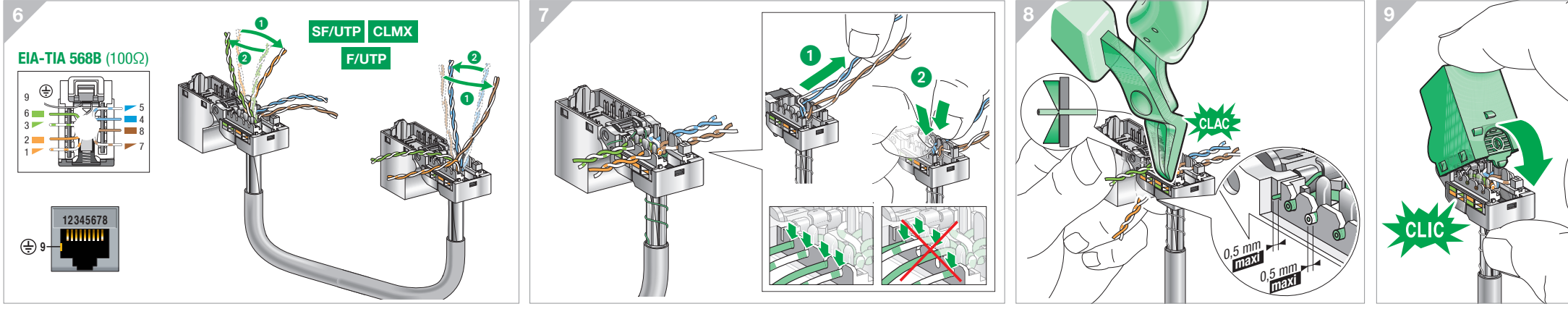
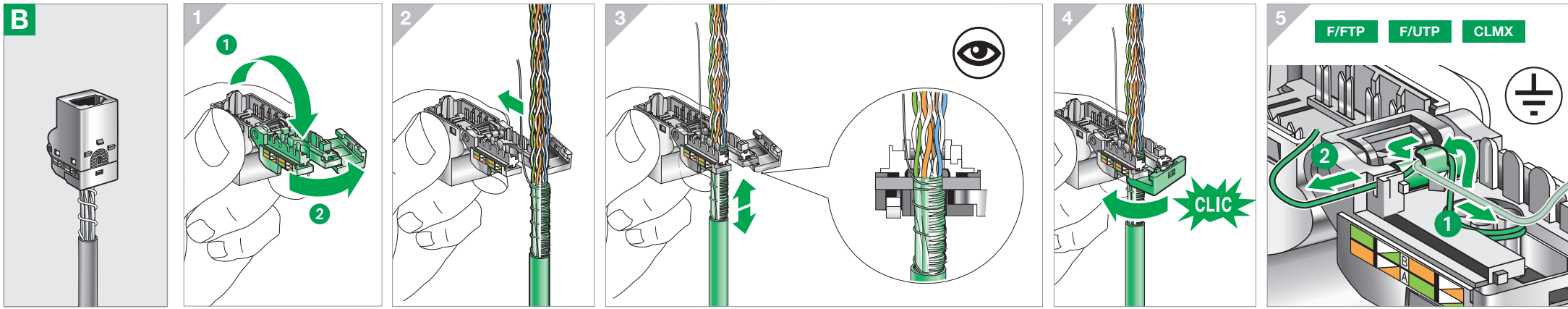
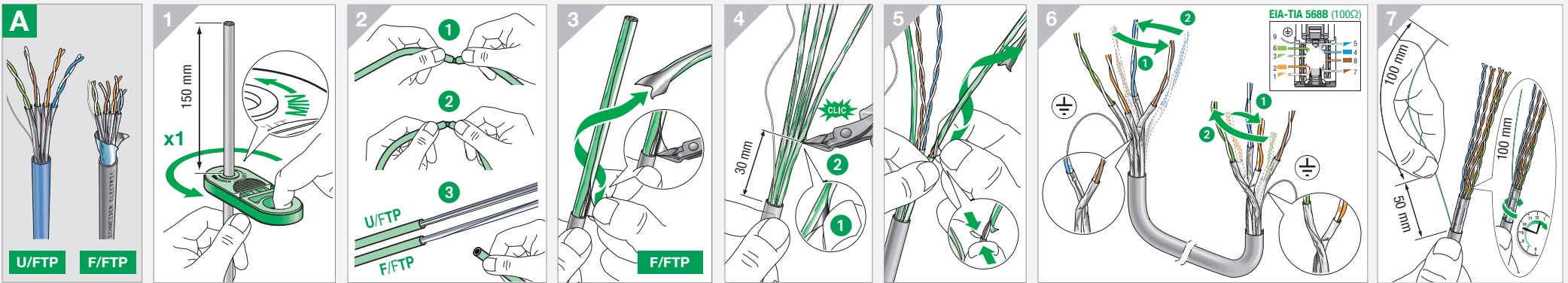

en. This product must be installed, connected and used in compliance with appli le standards and/or installation regulations.
As standards, specifications and designs develop from time to time, always ask for confirmation of the information given in this publication.

fr. Ce produit doit être installé, connecté et utilisé conformément aux normes applicables et/ou règles d'installation.
Du fait que les normes, les spécifications et les schémas peuvent être modifiés, nous vous recommandons de vérifier que la documentation de cette publication soit mise à jour.

es. Este producto debe ser instalado, conectado y utilizado en acuerdo con las normas aplicables y/o las reglas de instalación.
Dado que las normas, las especificaciones y los diseños se desarrollan de vez en cuando, se recomienda se aseguren que la información dada en esta publicación sea la correcta.

it. Questo prodotto deve essere installato, collegato ed usato in osservanza agli standards d'installazione e delle regolamentazioni di legge ad esso applicabili.
In ragione dell'evoluzione delle Norme e dei materiali, le caratteristiche riportate nei testi e nelle illustrazioni del presente documento si potranno ritenere impegnative solo dopo conferma da parte di Schneider Electric.

de. Die Installation und der Anschluss des Produktes dürfen nur in Übereinstimmung der geltenden Normen und Standards erfolgen.
Überzeugen Sie sich über die Gültigkeit der hier aufgeführten Inhalte durch mögliche Änderungen der Normen und Standards.

dk. Produktet skal installeres, tilsluttes og anvendes i henhold til gældende standarder og installationsregler.
Få altid bekræftet, om oplysningerne i dette dokument stadig er gældende, da specifikationer, standarder og design ændres løbende.

nl. Dit product moet worden geïnstalleerd, aangesloten en gebruikt worden in overeenstemming met de geldende normen en/of installatievoorschriften.
Omdat normen, specificaties en modellen kunnen evolueren in de tijd, altijd vragen om bevestiging van de informatie in deze publicatie.

no. Produktet skal installeres, tilkoples og anvendes i henhold til gjeldende standarder. Tämä tuote tulee asentaa, kytkeä ja käyttää voimassa olevien standardien ja/tai säännösten mukaisesti.
Standardit, määräykset ja mallit muuttuvat ajan myötä, varmista, että tämän julkaisun tiedot vastaavat nykyhetken vaatimuksia.

sv. Denna produkt måste installeras, anslutas och användas i enlighet med gällande standarder och installationsföreskrifter.
Eftersom standarder, specifikationer ändras med tiden, kontrollera att uppgifterna i denna publikation är aktuella mot gällande standarder.

fi. Tämä tuote tulee asentaa, kytkeä ja käyttää voimassa olevien standardien ja/tai säännösten mukaisesti.
Standardit, määräykset ja mallit muuttuvat ajan myötä, varmista, että tämän julkaisun tiedot vastaavat nykyhetken vaatimuksia.

pt. Este produto deve ser instalado, ligado e utilizado de acordo com as normas aplicáveis e/ou regras de instalação.
Dado que as normas, especificações e esquemas são atualizados periodicamente, solicite sempre confirmação da informação contida nesta publicação.

ru. Данное изделие должно быть установлено, подключено и использовано в соответствии с действующими стандартами и/или нормами и правилами по установке.
В случае изменения действующих стандартов, всегда руководствуйтесь информацией, приведенной в данной инструкции.

