

XBK H8100033E / XBK T81030U33E

XBK H8100033E

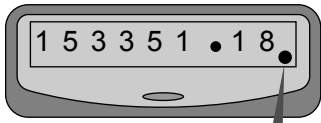

ON

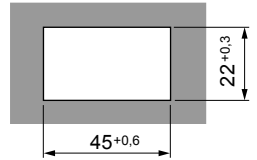
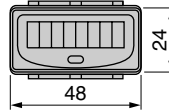
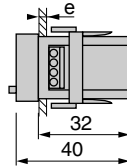

$e < 14 \text{ mm}$

1 mm = 0,039 inch

1 inch = 25.4 mm

mm ²	0.15	0.15	0.75	1
AWG	26...18	26...18	26...18	26...18
				Nm 0.2
$\varnothing 3,5 \text{ mm (0.14 in)}$				Pound-inch 1.8

Power supply : Internal by lithium battery. Non interchangeable (7 year life)
Alimentation : Interne par pile au lithium. Non interchangeable (7 ans)
Spannungsversorgung : Intern über Lithiumbatterie. Nicht austauschbar (7 Jahre)
Alimentación : Interna con pila de litio No intercambiable (7 años)
Alimentazione : Interna con pila al litio. Non intercambiabile (durata 7 anni)

Count input

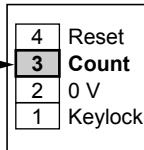
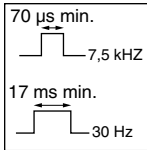

NPN
 $\geq 5 \text{ V}$
 $< 40 \text{ V}$
 $\leq 0,7 \text{ V}$

PNP
 $\leq 0,7 \text{ V}$
 $\geq 5 \text{ V}$
 $< 40 \text{ V}$

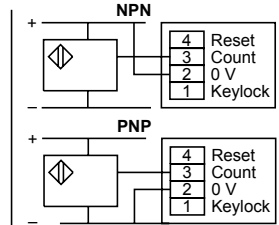

Reset input

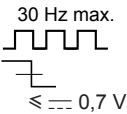
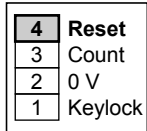

Locking of Reset key
 Verrouillage touche Reset
 Sperren der Reset-Taste
 Enclavamiento de la tecla Reset
 Blocco tastò Reset

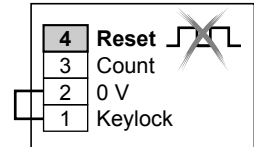

Degree of protection / Classe de protection / Schutzart / Grado de protección / Grado di protezione IP 54
 Operating temperature / - 10...+ 50 °C
 Température de fonctionnement / 14...+ 122 °F
 Betriebstemperatur /
 Temperatura de funcionamiento /
 Temperatura di funzionamento

Storage temperature / - 20...+ 60 °C
 Température de stockage / - 4...+ 140 °F
 Lagertemperatur /
 Temperatura de almacenamiento /
 Temperatura d'immagazzinamento

⚠ DANGER / DANGER / GEFAHR / PELIGRO / PERICOLO

HAZARDOUS VOLTAGE

- Disconnect all power before working on equipment.
 - Verify voltage is off by measurement.
 - Verify correct terminal connections when wiring.
Electric shock will result in death, serious injury or equipment damage.

TENSION DANGEREUSE

Coupez l'alimentation avant de travailler sur cet appareil.
Une électrocution entrainera la mort, des blessures graves ou des dommages matériels.

GEFAHRLICHE SPANNUNG

Vor dem Arbeiten an dem Gerät dessen Stromversorgung abschalten
Elektrischer Schlag mit Lebensgefahr bzw. schweren Verletzungen oder Materialschaden zur Folge haben!.

TENSIÓN PELIGROSA

Desconecte toda alimentación antes de realizar el servicio.
Una descarga eléctrica podría provocar la muerte, lesiones serias o daños materiales.

TENSIONE PERICOLOSA

Scollegare l'apparecchio dalla presa di corrente prima di qualsiasi intervento
Una scarica elettrica potrebbe causare la morte, gravi lesioni o danni alle apparecchiature.

XBK H8100033E

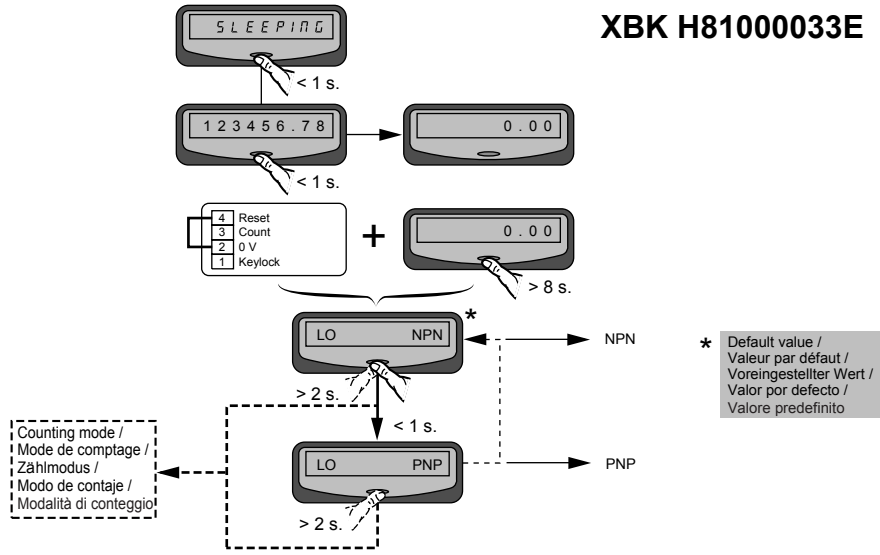

XBK T81030U33E

