

Coded magnetic switches
Interrupteurs magnétique codé
Codierte Magnetschalter
Interruptores magnéticos codificados
Interruttori magnetici codificati
Interruptores magnéticos codificados

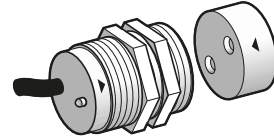
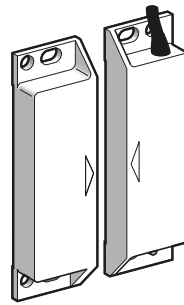
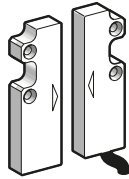

XCSDMC
XCSZC..... + XCSZC1

XCSDMP
XCSZP..... + XCSZP1

XCSDMR
XCSZR..... + XCSZR1

English

These devices have been designed to be in compliance with the standards currently in effect: EN/IEC 60947-5-1, EN/ISO 13849-1, EN/IEC 62061, EN/IEC 60947-1, EN/ISO 14119, EN/IEC 60204.
 These devices can achieve up to category 4 PL=e or SIL 3 (if combined with an appropriate PREVENTA XPS safety unit PL=e / SIL 3).

Français

Ces appareils ont été conçus d'après les normes actuellement en vigueur : EN/IEC 60947-5-1, EN/ISO 13849-1, EN/IEC 62061, EN/IEC 60947-1, EN/ISO 14119, EN/IEC 60204.
 Ces équipements peuvent atteindre un circuit de commande jusqu'à la catégorie 4 PL=e ou SIL 3 correspondant (en combinaison avec une unité de sécurité PREVENTA XPS appropriée PL=e / SIL 3).

Deutsch

Die Geräte wurden gemäß den geltenden Normen EN/IEC 60947-5-1, EN/ISO 13849-1, EN/IEC 62061, EN/IEC 60947-1, EN/ISO 14119, EN/IEC 60204 entwickelt.
 Diese Geräte können bis Kategorie 4 PL = e bzw. SIL 3 zu erreichen (wenn mit einer entsprechenden PREVENTA XPS Sicherheitsmodul kombiniert PL = e / SIL 3) erreichen.

Español

Estos dispositivos han sido diseñados de conformidad con las normas actualmente en vigor EN/IEC 60947-5-1, EN/ISO 13849-1, EN/IEC 62061, EN/IEC 60947-1, EN/ISO 14119, EN/IEC 60204.
 Estos dispositivos permiten conseguir hasta la categoría 4 PL = e o SIL 3 (si se combina con una unidad de seguridad PREVENTA XPS apropiado PL = e / SIL 3).

Italiano

Questi dispositivi sono stati progettati secondo le norme in vigore: EN/IEC 60947-5-1, EN/ISO 13849-1, EN/IEC 62061, EN/IEC 60947-1, EN/ISO 14119, EN/IEC 60204.
 Questi dispositivi consentono di ottenere fino a categoria 4 PL = e o SIL 3 (se combinato con un adeguato unità di sicurezza PREVENTA XPS PL = e / SIL 3).

Português

Estes aparelhos foram concebidos para estar em conformidade com as normas em vigor: EN/IEC 60947-5-1, EN/ISO 13849-1, EN/IEC 62061, EN/IEC 60947-1, EN/ISO 14119, EN/IEC 60204.
 Estes aparelhos permitem atingir até à categoria 4 PL = e ou SIL 3 (se combinado com uma unidade de segurança PREVENTA XPS apropriado PL = e / SIL 3).

Dimensions / Encombrements / Abmessungen / Dimensiones / Dimensioni / Dimensões

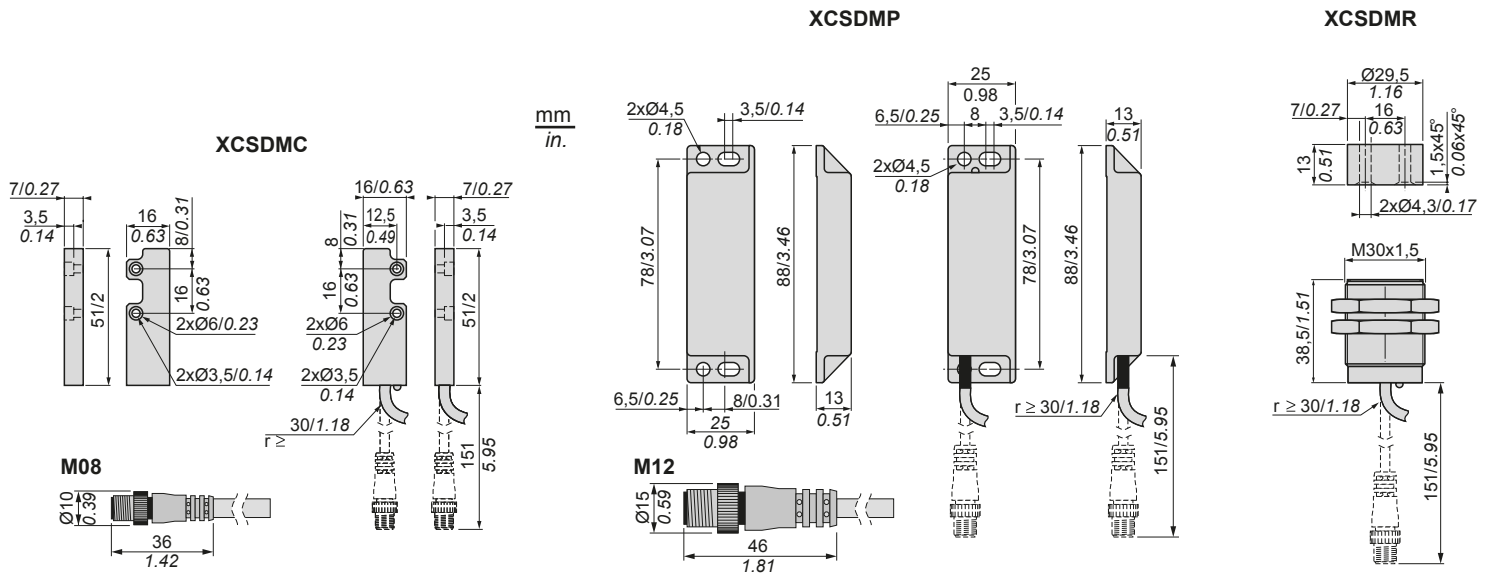

- (en) Electrical equipment should be installed, operated and maintained only by qualified personnel. No responsibility is assumed by Schneider Electric for any consequences arising out of the use of this material.
- (fr) Les équipements électriques doivent être installés, exploités et entretenus par un personnel qualifié. Schneider Electric n'assume aucune responsabilité des conséquences éventuelles découlant de l'utilisation de cette documentation.
- (de) Elektrische Geräte dürfen nur von Fachpersonal installiert, betrieben, gewartet und instand gesetzt werden. Schneider Electric haftet nicht für Schäden, die aufgrund der Verwendung dieses Materials entstehen.
- (es) Sólo el personal de servicio cualificado podrá instalar, utilizar, reparar y mantener el equipo eléctrico. Schneider Electric no asume las responsabilidades que pudieran surgir como consecuencia de la utilización de este material.
- (it) Le apparecchiature elettriche devono essere installate, usate e riparate solo da personale qualificato. Schneider Electric non assume nessuna responsabilità per qualunque conseguenza derivante dall'uso di questo materiale.
- (pt) A instalação, utilização e manutenção do equipamento eléctrico devem ser efectuadas exclusivamente por pessoal qualificado. A Schneider Electric não assume qualquer responsabilidade pelas consequências resultantes da utilização deste material.

© 2017 Schneider Electric. "All Rights Reserved."

Safety solutions using Preventa
Solutions de sécurité selon Preventa
Sicherheitslösungen mit Preventa
Soluciones de seguridad según Preventa
Soluzioni di sicurezza secondo Preventa
Soluções de segurança da Preventa

Cable connection procedures
Procédures de connexion des câbles
Kabelanschlüsse
Procedimentos de conexión de los cables
Procedure di collegamento dei cavi
Procedimentos para a conexão de cabos

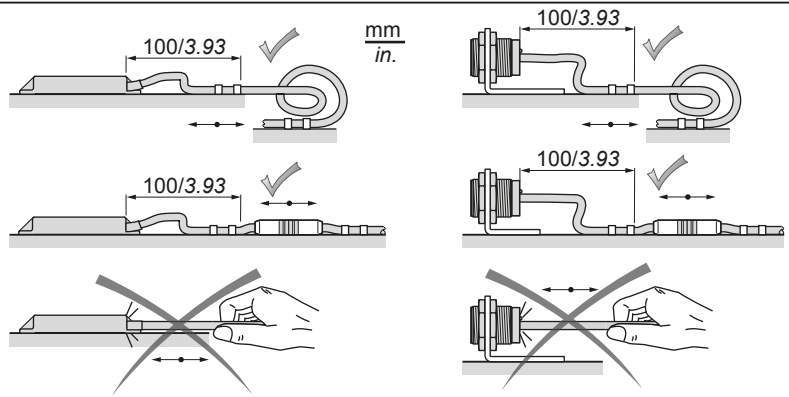

⚠ WARNING / AVERTISSEMENT / WARNUNG / ADVERTENCIA / AVVERTIMENTO / AVISO

UNINTENDED EQUIPMENT OPERATION

- Do not use magnetic or magnetized screws to mount safety switches.
- Do not mount safety switches in locations subject to magnetic fields in excess of 0.3 mT.

Failure to follow these instructions can result in death, serious injury, or equipment damage.

FNCTIONNEMENT INATTENDU DE L'EQUIPEMENT

- Ne pas monter les interrupteurs de sécurité à l'aide de vis magnétiques ou de vis magnétisées.
- Ne pas monter les interrupteurs de sécurité dans des endroits exposés à des champs magnétiques supérieurs à 0,3 mT.

Le non-respect de ces instructions peut provoquer la mort, des blessures graves ou des dommages matériels.

UNBEABSICHTIGTER GERÄTEBETRIEB

- Verwenden Sie keine Magnet- oder magnetisierten Schrauben, um die Sicherheitsschalter zu montieren.
- Montieren Sie keine Sicherheitsschalter in Umgebungen, die Magnetfeldern über 0.3 mT ausgesetzt sind.

Die Nichtbeachtung dieser Anweisungen kann zu Tod, schwerer Körperverletzung oder Materialschäden führen.

FUNCIONAMIENTO INESPERADO DEL EQUIPO

- Los interruptores de seguridad no deben instalarse por medio de tornillos magnéticos o magnetizados.
- Los interruptores de seguridad no deben instalarse en ubicaciones expuestas a campos magnéticos de más de 0.3 mT.

Si no se siguen estas instrucciones pueden producirse lesiones personales graves o mortales o daños en el equipo.

FUNZIONAMENTO NON INTENZIONALE DELL' APPARECCHIATURA

- Non utilizzare viti magnetiche o magnetizzate per montare gli interruttori di sicurezza.
- Non montare gli interruttori di sicurezza in posti soggetti a campi magnetici superiori a 0,3 mT.

Il mancato rispetto di queste istruzioni può provocare morte, gravi infortuni o danni alle apparecchiature.

FUNCIONAMENTO NÃO PREVISTO DOS EQUIPAMENTOS

- Não utilize parafusos magnéticos ou magnetizados para montar os interruptores de segurança.
- Não monte os interruptores de segurança em locais sujeitos a campos magnéticos de intensidade superior a 0,3 mT.

A não observância destas instruções pode provocar a morte, ferimentos graves, ou danos no equipamento.

⚠ CAUTION / ATTENTION / ACHTUNG / AVISO / ATTENZIONE / ATENÇÃO

RISK OF MATERIAL DAMAGE

- Do not use safety switch as a mechanical stop.
- Do not adjust the position of switches using a hammer or other tool likely to exceed the device's shock and vibration tolerances.

Failure to follow these instructions can result in injury or equipment damage.

RISQUE DE DOMMAGE MATERIEL

- Ne pas utiliser les interrupteurs de sécurité comme butées mécaniques.
- Ne pas régler la position des interrupteurs à l'aide d'un marteau, ou de tout autre outil qui pourrait dépasser les tolérances du dispositif aux chocs et aux vibrations.

Le non-respect de ces instructions peut provoquer des blessures ou des dommages matériels.

GEFAHR VON MATERIALSCHÄDEN

- Verwenden Sie den Sicherheitsschalter nicht als mechanische Abschaltung.
- Passen Sie die Position der Schalter nicht mit einem Hammer oder einem anderen Werkzeug an, die wahrscheinlich die Toleranzwerte für Geräteschläge und-vibrationen überschreiten.

Die Nichtbeachtung dieser Anweisungen kann zu Körperverletzungen oder Materialschäden führen.

RIESGO DE DAÑOS MATERIALES

- Los interruptores de seguridad no deben utilizarse como topes mecánicos.
- La posición de los interruptores no debe ajustarse por medio de un martillo u otra herramienta que podría exceder las tolerancias del dispositivo a los choques y vibraciones.

Si no se siguen estas instrucciones pueden producirse lesiones personales o daños en el equipo.

RISCHIO DI DANNI MATERIALI

- Non utilizzare il vostro interruttore di sicurezza come arresto meccanico.
- Non regolare la posizione degli interruttori con un martello o un altro attrezzo simile che possa superare le tolleranze d'urto e di vibrazione del dispositivo.

Il mancato rispetto di queste istruzioni può provocare infortuni o danni alle apparecchiature.

DANOS NOS EQUIPAMENTOS

- Não utilize o interruptor de segurança como um meio de paragem mecânico.
- Não ajuste a posição dos interruptores utilizando um martelo ou outra ferramenta susceptível de ultrapassar as tolerâncias aos choques e às vibrações do dispositivo.

A não observância destas instruções pode provocar ferimentos pessoais, ou danos no equipamento.

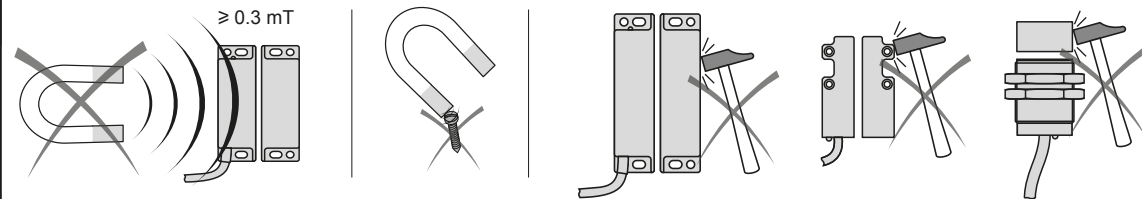

Functional directions - Minimum distance between the magnet and the sensor
Directions fonctionnelles - Distance minimale entre l'aimant et le capteur
Funktions-Richtungen - Mindestabstand zwischen dem Magneten und dem Sensor
Direcciones funcionales - Distancia mínima entre el imán y el sensor
Direzioni funzionali - Distanza minima tra il magnete e il sensore
Direções funcionais - Distância mínima entre o íman eo sensor

XCSDMC

XCS DMP

XCS DMR

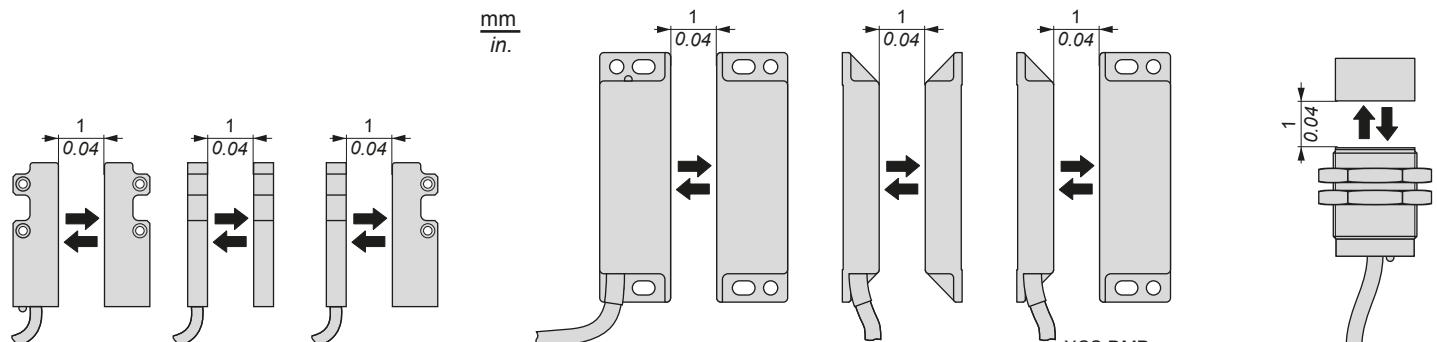

XCS DMC: Sao 4 mmm/0.16 in.

XCS DMP:
Sao 4 mmm/0.16 in.

Sao : Assured Operating Distance / Portée de travail assurée / Gewährleisteter Arbeitsbereich / Alcance de trabajo asegurado / Portata di lavoro garantita / Alcance de trabalho assegurado

1 mm = 0.04 in.

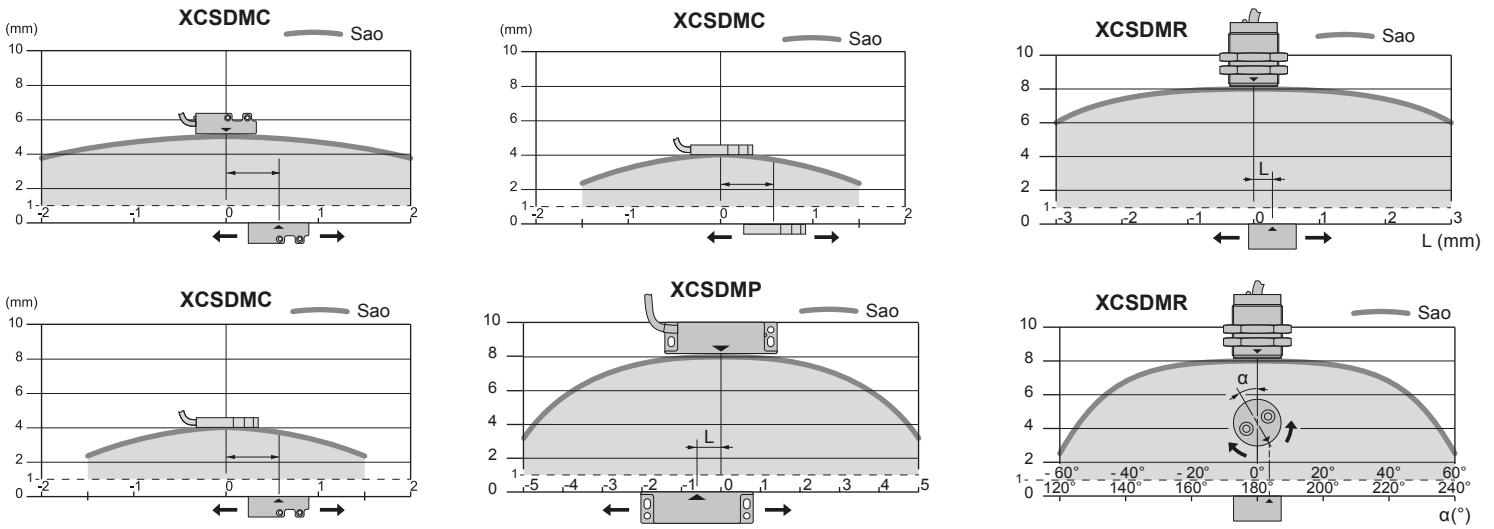

Minimum mounting clearances between safety switches and ferromagnetic materials
Espaces de dégagement minimum, au montage, entre interrupteurs de sécurité et matériaux ferromagnétiques
Minimaler Abstand zwischen Sicherheitsschaltern und ferromagnetischen Materialien
Espacios libres mínimos para el montaje, entre los interruptores de seguridad y los materiales ferromagnéticos
Spazio di montaggio minimo tra gli interruttori di sicurezza e materiali ferromagnetici;
Distâncias mínimas de montagem entre interruptores de segurança e materiais ferromagnéticos

	mm / in.	a ≥	b ≥	c x d ≥
XCSDMC		40/1.57	13/0.51	81/3.19 x 55/2.16
XCSDMP		100/3.94	10/0.39	118/4.64 x 55/2.16

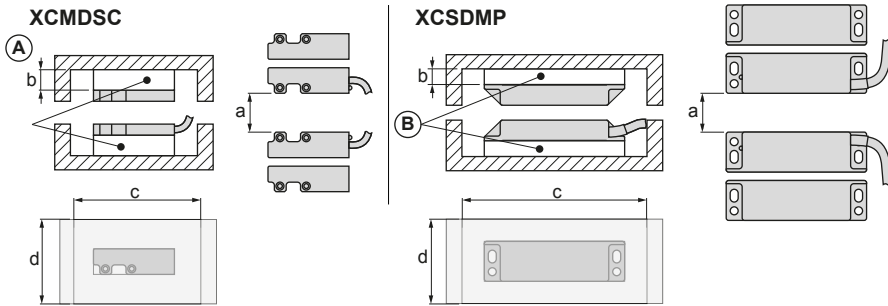

- A, B and C non-magnetic shim
 - A, B et C cale amagnétique
 - A, B und C unmagnetischer Keil
 - A, B y C calce amagnético
 - A, B e C spessore amagnetico
 - A, B e C calço não magnético
- A = XCS ZCC (x2)
 B = XCS ZCP (x2)
 C = XCS ZCR (x1)

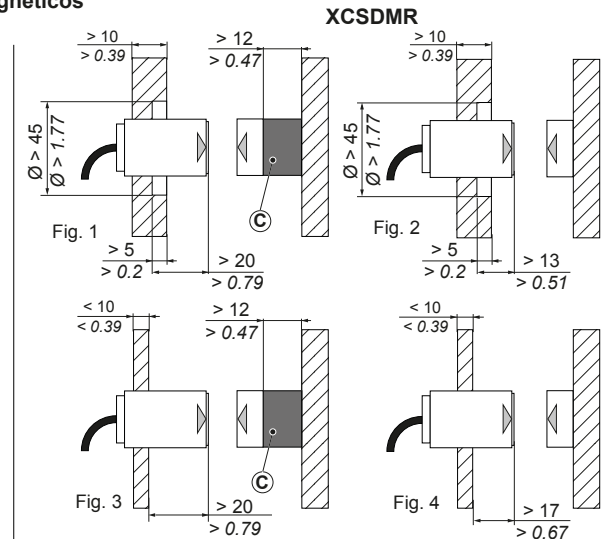

Tightening torque, tightening capacity
Couple de serrage, capacité de serrage
Anzugdrehmoment, Anzugvermögen
Par de apriete, capacidad de apriete
Coppia di serraggio, capacità di serraggio
Binário de aperto, capacidade de aperto

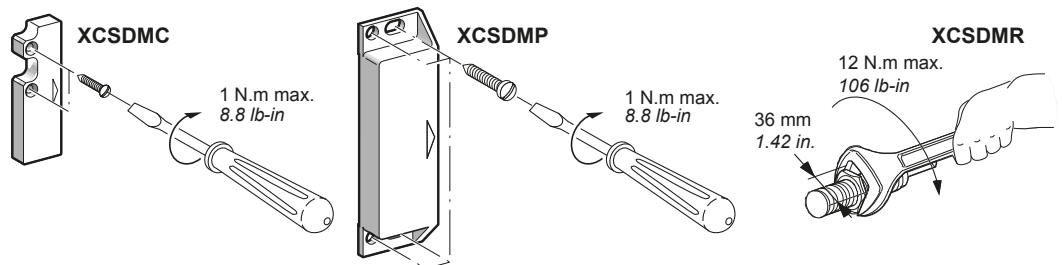

Pre-Wired Female Connectors
Prolongateurs
Verlängerungskabel
Extensiones de cables
Prolunghe
Cabos de Extensão

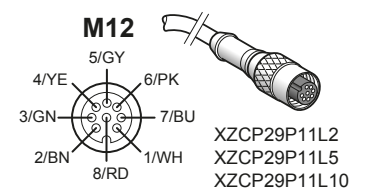
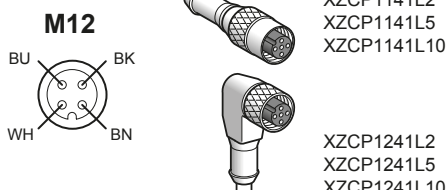
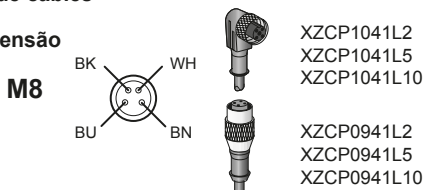

Wiring diagram / Mise en œuvre électrique / Anschluß Schema / Instalación eléctrica / Collegamenti elettrici / Instalação eléctrica

Illustration of contacts with magnet present
 Représentation des contacts en présence de l'aimant
 Darstellung der Kontakte, bei Magnetbetätigung
 Representación de los contactos en presencia del imán
 Rappresentazione dei contatti in presenza del magnete
 Representação dos contactos em presença do ímã

Cat. 4 / PL=e (EN/ISO 13849-1) / SIL3 - XPSDMB
XCS DMC59.. / XCS DMR59.. / XCS DMP50..
 (NC + NO) (NC + NO) (NC + NC + NO)

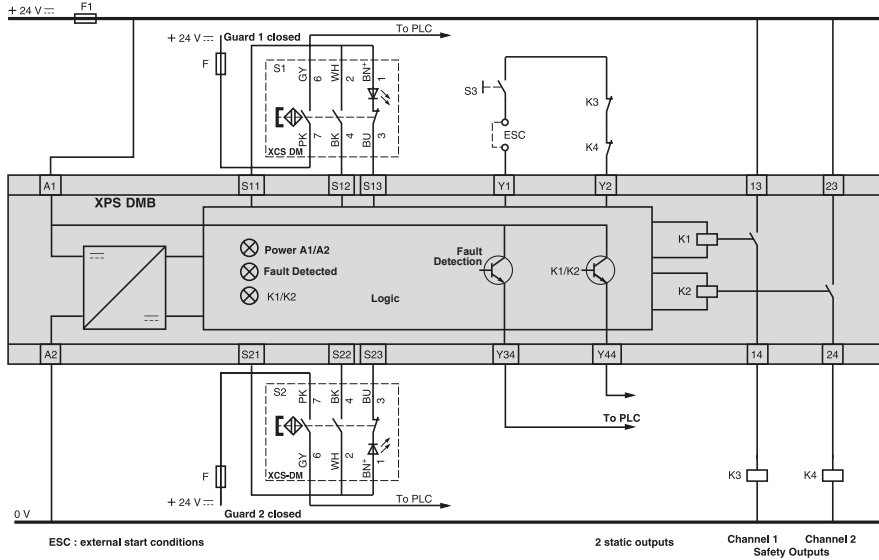

Cat. 4 / PL=e (EN/ISO 13849-1) / SIL3 - XPSDME
XCS DMC59.. / XCS DMR59.. / XCS DMP50.. / XCS DMP59..
 (NC + NO) (NC + NO) (NC + NC + NO) (NC + NO)

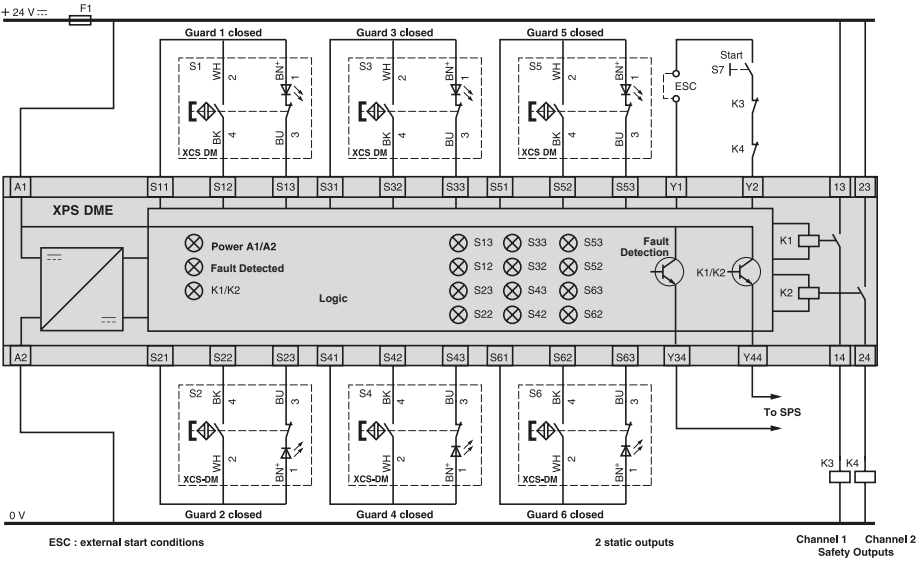

Cat. 4 / PL=e (EN/ISO 13849-1) / SIL3 - XPSAF

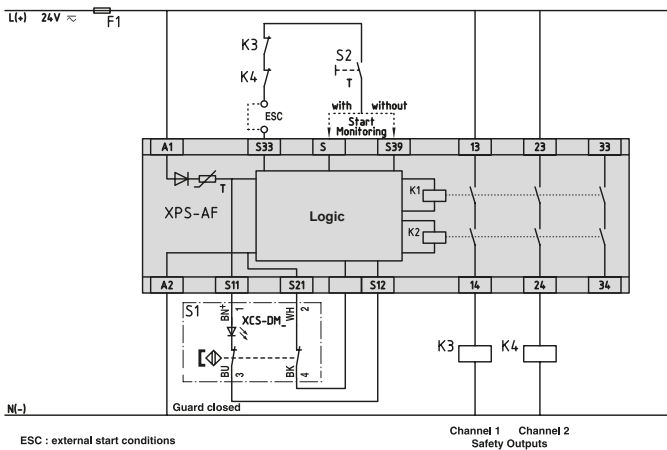

⚠ DANGER / DANGER / PELIGRO

HAZARD OF ELECTRIC SHOCK, EXPLOSION OR ARC FLASH
 Disconnect all power before servicing equipment.
Failure to follow these instructions will result in death or serious injury.

RISQUE D'ELECTROCUTION, D'EXPLOSION OU D'ARC ELECTRIQUE
 Coupez l'alimentation avant de travailler sur cet appareil.
Le non-respect de ces instructions provoquera la mort ou des blessures graves.

RIESGO DE ELECTROCUCIÓN, EXPLOSIÓN O ARCO ELÉCTRICO
 Desconecte toda alimentación antes de realizar el servicio.
Si no se respetan estas instrucciones, se producirán graves daños corporales o la muerte.

Cat. 3 / PL=d (EN/ISO 13849-1) / SIL2 - XPSDMB

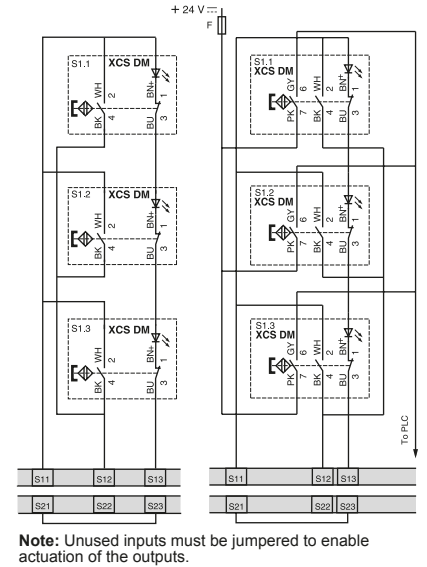

Note: Unused inputs must be jumpered to enable actuation of the outputs.

Cat. 3 / PL=d (EN/ISO 13849-1) / SIL2 - XPSDME

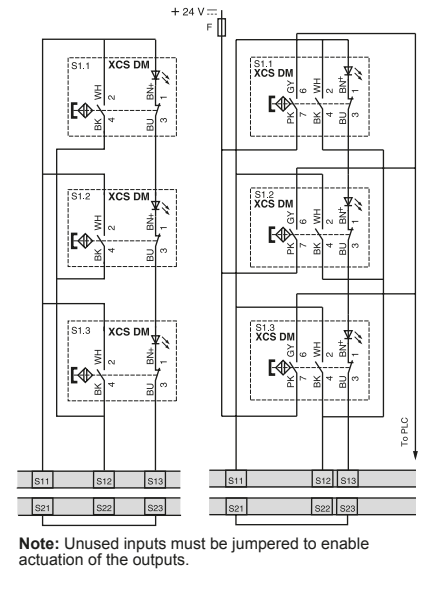

Note: Unused inputs must be jumpered to enable actuation of the outputs.

XCSDMC79..	NC + NC
XCS DMP79..	
XCS DMR79..	
XCS DMP70..	NC + NC + NO

M8
XCS DMC... ..

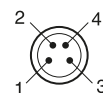

M12

XCS DMP●9
XCS DMR●9

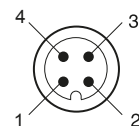

XCS DMP●0

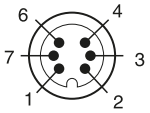

Safety solutions using Preventa / Solutions de sécurité selon Preventa / Sicherheitslösungen mit Preventa / Soluciones de seguridad según Preventa / Soluzioni di sicurezza secondo Preventa / Soluções de segurança da Preventa

Contact status with magnet present
 Etat des contacts en présence de l'aimant
 Kontaktspiegel bei Magnetbetätigung
 Estado de los contactos en presencia del imán
 Stato dei contatti in presenza del magnete
 Estado dos contactos em presença do ímã

-Contact closed (1)
 -Contact fermé (1)
 -Kontakt geschlossen (1)
 - Contacto cerrado (1)
 - Contatto chiuso (1)
 - Contacto fechado (1)

-Contact open (0)
 -Contact ouvert (0)
 -Kontakt geöffnet (0)
 - Contacto abierto (0)
 - Contatto aperto (0)
 - Contacto aberto (0)

-Transient state
 -Etat transitoire
 -Übergangszustand
 - Estado transitorio
 - Stato transitorio
 - Estado transitório

XCS DMC59●●

(mm/in.)



XCS DMC79●●

(mm/in.)

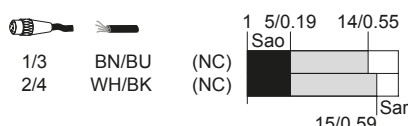

XCS DMP50●●

(mm/in.)

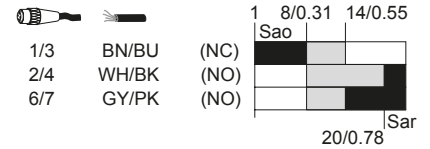

XCS DMP70●●

(mm/in.)

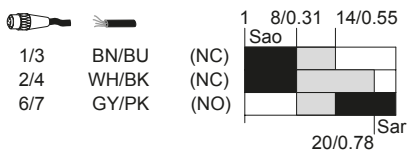

XCS DMR59●● XCS DMP59●●

(mm/in.)



XCS DMR79●● XCS DMP79●●

(mm/in.)

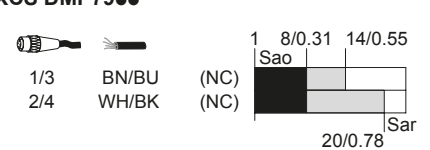

Sao : Assured Operating Distance
 Sao : portée de travail assurée
 Sao : gewährleisteteter Arbeitsbereich
 Sao : alcance de trabajo asegurado
 Sao : zona di lavoro garantita
 Sao : alcance de trabalho assegurado





































Sar : Assured Release Distance
 Sar : portée de déclanchement assurée
 Sar : gewährleisteteter Auslösebereich
 Sar : alcance de activación asegurada
 Sar : distanza minima per garantire l'intervento
 Sar : alcance de activação assegurado

en Characteristics

Ambient air temperature	Operation: - 13 °F to 185 °F (- 25...85 °C) / Storage: - 40 °F to 185 °F (- 40...85 °C)
Vibration resistance	10 gn (10-150 Hz) conforming to EN/IEC 60068-2-6
Shock resistance	30 gn (11 ms) conforming to EN/IEC 60068-2-27
Protection against electric shock	Class II conforming to EN/IEC 61140
Degree of protection	☞ : IP 66 + IP 67 ☞ : IP 67 Per IEC 60529
Degree of pollution	3, conforming to IEC / EN 60947-5-1
Required Fusing Protection (using without safety module)	500 mA gG (gl) cartridge fuse
Rated operating characteristics	Ue = 24 V ~ Ie = 100 mA
Repeat accuracy	≤ 10 %
Hysteresis	≤ 20 %
Frequency of operating cycle	150 Hz
B _{10d}	50 million cycles at 10mA
Drop out voltage	I ± 10 mA 0.1 Vdc without LED; 2.4 Vdc with LED
	I ± 100 mA 1 Vdc without LED; 4.2 Vdc with LED
Cable connection	Use cables with 4 or 6 conductors such as the M8 or M12 cables pictured here: M8 ☺; M12 ☺☺☺ The minimum conductor wire size is 0.25 mm ² (24 AWG). Typical cable lengths are 2 m, 5 m, and 10 m (6.6 ft, 16.4 ft, 32.8 ft).

fr Caractéristiques

Température de l'air ambiant	Pour fonctionnement : - 25...85 °C / Pour stockage : - 40...85 °C
Tenue aux vibrations	10 gn (10... 150 Hz) selon EN/IEC 60068-2-6
Tenue aux chocs	30 gn (durée 11 ms) selon EN/IEC 60068-2-27
Protection contre les chocs électriques	Classe II selon EN/IEC 61140
Degré de protection	☞ : IP 66 + IP 67 ☞ : IP 67 suivant IEC 60529
Degré de pollution	3, selon IEC / EN 60947-5-1
Protection par fusible nécessaire (utilisation hors module de sécurité)	Cartouche fusible 500 mA gG (gl)
Caractéristiques assignées d'emploi	Ue = 24 V ~ Ie = 100 mA
Reproductibilité	≤ 10 %
Hystérésis	≤ 20 %
Fréquence de commutation	150 Hz
B _{10d}	50 millions de cycles à 10mA
Chute de tension	I ± 10 mA 0,1 V ~ sans LED; 2,4 V ~ avec LED
	I ± 100 mA 1 V ~ sans LED; 4,2 V ~ avec LED
Raccordement	Utiliser des câbles à 4 ou 6 conducteurs, tels que les câbles M8 ou M12 représentés ici : M8 ☺; M12 ☺☺☺ Calibre minimal du fil : 0.25 mm ² (24 AWG). Longueurs de câbles types : 2 m, 5 m, and 10 m.

(de) Technische Daten	
Umgebungstemperatur	Betrieb : - 25...85 °C Lagerung : - 40...85 °C
Vibrationsfestigkeit	10 gn (10...150 Hz) gemäß EN/IEC 60068-2-6
Schockfestigkeit	30 gn (Dauer 11 ms) gemäß EN/IEC 60068-2-27
Schutz gegen Spannungstöße	Klasse II gemäß EN/IEC 61140
Schutzart	 : IP 66 + IP 67  : IP 67 gemäß IEC 60529
Verschmutzungsgrad	3, gemäß IEC / EN 60947-5-1
Erforderlicher Sicherungsschutz (Verwendung außerhalb des Sicherheitsmodul)	Sicherung 500 mA gG (gl)
Nennbetriebsdaten	Ue = 24 V  le = 100 mA
Schaltgenauigkeit	≤ 10 %
Hysteresis	≤ 20 %
Schaltfrequenz	150 Hz
B _{10d}	50 Millionen Zyklen bei 10mA
Spannungsabfall	I ± 10 mA 0,1 V  ohne LED; 2,4 V  mit LED
	I ± 100 mA 1 V  ohne LED; 4,2 V  mit LED
Elektrischer Anschluß	Verwenden Sie Kabel mit 4 oder 6 Leitern, wie die hier abgebildeten M8- oder M12-Kabel: M8  ; M12  Minimale Größe des Leiterdrahtes: 0.25 mm ² (24 AWG). Kabellängen in der Regel: 2 m, 5 m und 10 m.
(es) Características	
Temperaturas ambiente	Para funcionamiento: - 25...85 °C Para almacenamiento: - 40...85 °C
Resistencia a las vibraciones	10 gn (10 ... 150 Hz) según EN/IEC 60068-2-6
Resistencia a los impactos	30 gn (duración 11 ms) según EN/IEC 60068-2-27
Protección contra las descargas eléctricas	Clase II según EN/IEC 61140
Grado de protección	 : IP 66 + IP 67  : IP 67 conforme a la IEC 60529
Grado de contaminación	3, según IEC / EN 60 947-5-1
Se requiere una protección por fusible (utilización fuera del módulo de seguridad)	Cartucho fusible 500 mA gG (gl)
Características de uso	Ue = 24 V  le = 100 mA
Reproductibilidad	≤ 10 %
Histéresis	≤ 20 %
Frecuencia de conmutación	150 Hz
B _{10d}	50 millones de ciclos en 10mA
Caída de tensión	I ± 10 mA 0,1 V  sin LED; 2,4 V  con LED
	I ± 100 mA 1 V  sin LED; 4,2 V  con LED
Conexión	Utilizar cables con 4 o 6 conductores, como los cables M8 o M12 representados a continuación: M8  ; M12  Calibre mínimo del hilo 0.25 mm ² (24 AWG). Longitudes de cables estándares: 2 m, 5 m, y 10 m.
(it) Caratteristiche	
Temperatura ambiente	Funzionamento: - 25...85 °C Stoccaggio: - 40...85 °C
Tenuta alle vibrazioni	10 gn (10 ... 150 Hz) secondo EN/IEC 60068-2-6
Tenuta agli urti	30 gn (durata 11 ms) secondo EN/IEC 60068-2-27
Protezione contro gli choc elettrici	Classe II secondo EN/IEC 61140
Grado di protezione	 : IP 66 + IP 67  : IP 67 Per IEC 60529
Grado d'inquinamento	3, secondo IEC / EN 60 947-5-1
Protezione con fusibili richiesta (senza modulo di sicurezza)	Fusibile 500 mA gG (gl)
Caratteristiche nominali d'impiego	Ue = 24 V  le = 100 mA
Ripetibilità	≤ 10 %
Isteresi	≤ 20 %
Frequenza di commutazione	150 Hz
B _{10d}	50 milioni di cicli a 10mA
Calo di tensione	I ± 10 mA 0,1 V  senza LED; 2,4 V  con LED
	I ± 100 mA 1 V  senza LED; 4,2 V  con LED
Collegamento	Usare cavi con 4 o 6 conduttori come i cavi M8 o M12 illustrati a seguito: M8  ; M12  Le dimensioni minime del cavo conduttore sono di 0.25 mm ² (24 AWG). Le lunghezze dei cavi sono di 2 m, 5 m e 10 m.
(pt) Características	
Temperatura ambiente	Funcionamento: - 25...85 °C Armazenagem: - 40...85 °C
Comportamento às vibrações	10 gn (10 ... 150 Hz) segundo EN/IEC 60068-2-6
Comportamento aos choques	30 gn (duração 11 ms) segundo EN/IEC 60068-2-27
Protecção contra os choques eléctricos	Classe II segundo EN/IEC 61140
Grau de protecção	 : IP 66 + IP 67  : IP 67 Per IEC 60529
Grau de poluição	3, segundo IEC / EN 60947-5-1
Protecção de Fusíveis Necessária (utilização sem módulo de segurança)	Cartucho fusível 500 mA gG (gl)
Características estipuladas de emprego	Ue = 24 V  le = 100 mA
Reprodutibilidade	≤ 10 %
Histeresis	≤ 20 %
Frequência de comutação	150 Hz
B _{10d}	50 milhões de ciclos de 10mA
Queda de tensão	I ± 10 mA 0,1 V  sem LED; 2,4 V  com LED
	I ± 100 mA 1 V  sem LED; 4,2 V  com LED
Ligações	Utilize cabos com 4 ou 6 condutores, tais como os cabos M8 ou M12 aqui apresentados: M8  ; M12  A dimensão mínima do fio condutor é de 0.25 mm ² (24 AWG). Os comprimentos típicos dos cabos são de 2 m, 5 m, e 10 m.