

Will

Et votre écran devient mobile !



ORIGINE
FRANCE[®]
GARANTIE

BVCert. 6164725

ERARD[®]

Will 1050 L, 1400 XL et 1600 XL

CARACTÉRISTIQUES TECHNIQUES

- Réglage de l'écran en hauteur
- Tablette en verre trempé clair
- Peinture époxy
- Colonne largeur 150 mm



Gestion des câbles dans la colonne

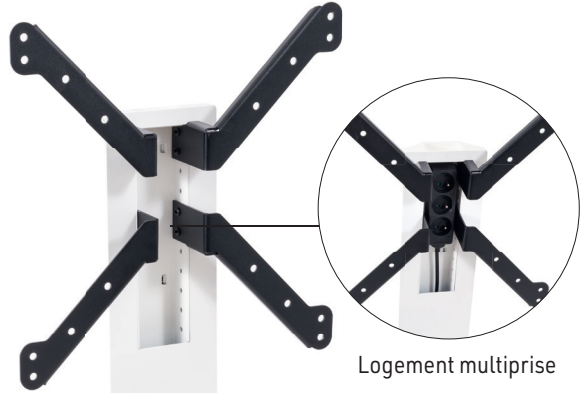

Logement multiprise

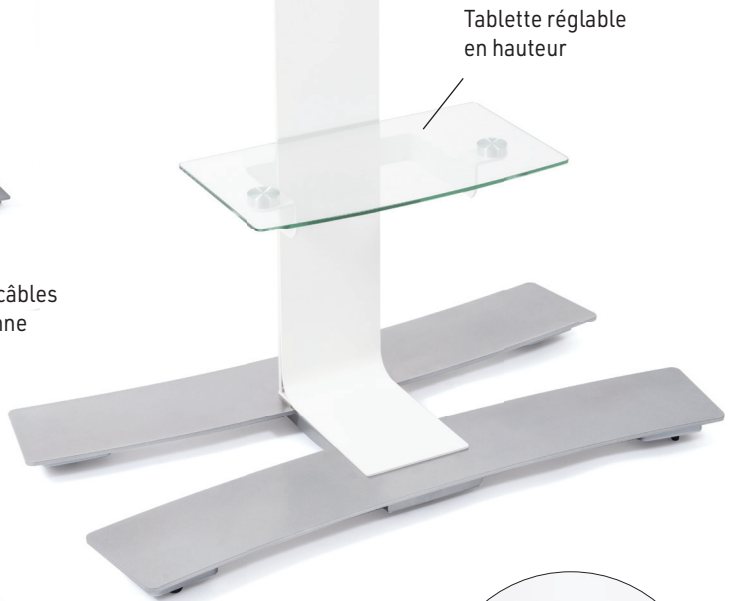

Tablette réglable en hauteur



2 couleurs disponibles :
Blanc ou Noir

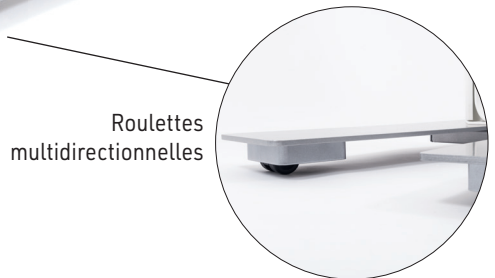

Roulettes multidirectionnelles

Will 1050 L

Ref.	039020 - Blanc	EAN	318528 039020 5
Ref.	039021 - Blanc + tablette	EAN	318528 039021 2
Ref.	039030 - Noir	EAN	318528 039030 4
Ref.	039031 - Noir + tablette	EAN	318528 039031 1

- Réglage de l'écran en hauteur sur 125 mm
- Réglage en hauteur de la tablette +/- 75 mm
- Socle en acier 6 mm
- 6 roulettes multidirectionnelles Ø35 mm

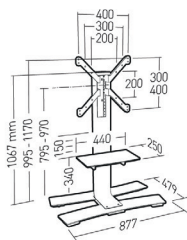

L 30"-65"
76-165 cm



30 KG



VESA
200x400



EPAISSEUR MAX
50 mm



Will 1400 XL

Ref.	039040 - Blanc	EAN	318528 039040 3
Ref.	039041 - Blanc + tablette	EAN	318528 039041 0
Ref.	039050 - Noir	EAN	318528 039050 2
Ref.	039051 - Noir + tablette	EAN	318528 039051 9

- Réglage de l'écran en hauteur sur 125 mm
- Réglage en hauteur de la tablette +/- 100 mm
- Socle en acier 8 mm
- 6 roulettes multidirectionnelles Ø35 mm
- Positionnement écran portrait ou paysage (sauf VESA 600x400)

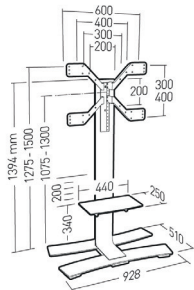

XL 40"-65"
101-216 cm



50 KG



VESA
200x600x400



EPAISSEUR MAX
80 mm



Will 1600 XL

Ref.	039060 - Blanc	EAN	318528 039060 3
Ref.	039070 - Noir	EAN	318528 039070 2

- Réglage de l'écran en hauteur sur 200 mm
- Socle en acier 8 mm
- 10 roulettes multidirectionnelles Ø35 mm
- Positionnement écran portrait ou paysage
- Tablette en option

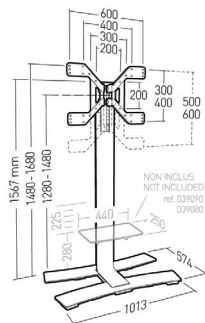

XXL 40"-100"
101-254 cm



65 KG



VESA
200x600x400



EPAISSEUR MAX
100 mm



Options

Tablette

Ref.	039080 - Blanc	EAN	318528 039080 9
Ref.	039090 - Noir	EAN	318528 039090 8

- Tablette additionnelle porte périphérique.
- Réglable en hauteur.
- Tablette en verre trempé de 6 mm.
- Dimensions : 440 x 250 mm.
- Épaisseur totale : 72 mm.

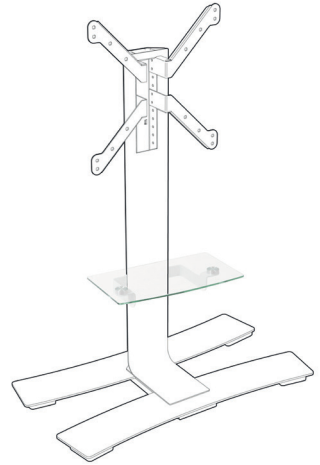

Box-Up

Ref	038401	EAN	318528 038401 3
-----	---------------	-----	-----------------

- Support porte périphérique positionné derrière l'écran sur la tête de fixation
- Fixation par 2 vis.
- Support en acier peinture époxy noire.
- Maintien du périphérique par 3 sandows.
- Reversible droite gauche.
- Dimensions (HxLxP) : 290 x 288 x 31 mm.



ERARD®
ACCESSOIRES ESSENTIELS
POUR MATÉRIELS AUDIO VIDÉO

E-Mail: infos@erard.fr / www.erard.com / Tel.: +33 (0)4 72 46 16 26 - TVA : FR 81 403 591 415

Z.I. de Chavanoz / 4 route de la Plaine / 38236 CHAVANOZ / France

