

# NAGA

UX Design Furniture\*



\* A design based on user experience

**ERARD**®

Discover the Naga video



[www.erard.com/naga](http://www.erard.com/naga)



### 3 SIZES

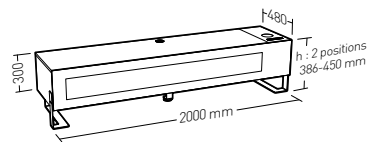
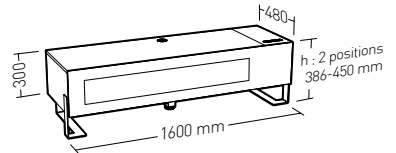
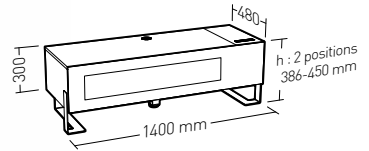

- Steel structure in black textured epoxy paint
- Quality melamine wood panels from suppliers of the leading brands of kitchen and office furniture
- Black screen-printed tempered glass door
- Opening system with gas springs and triple 2-axe adjustable concealed hinges
- Load reinforcement under the top shelf, max weight 50kg
- Wide back openings for equipment ventilation
- Steel column, swivelling and tilting (sold as an option)

2 COLOURS



CARBON wood

NORDIC wood

2 TECHNICAL VERSIONS



Hatch



Hatch + Qi  
+ 4 USB Charger

1 OPTIONAL  
COLUMN

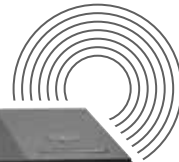

# YOU AND YOUR USE...

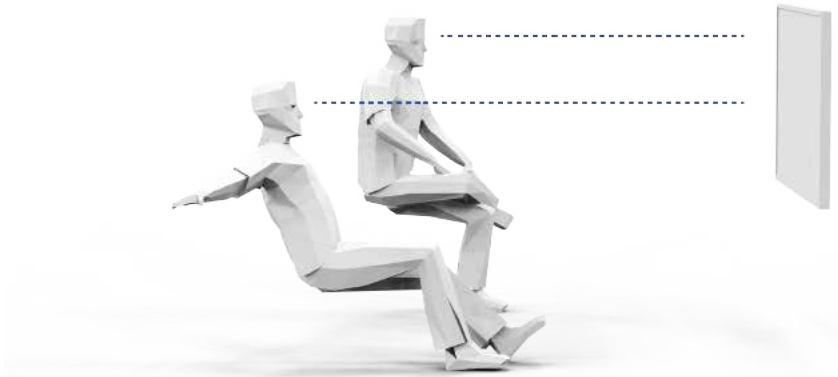

Because we do not all watch TV in the same way...

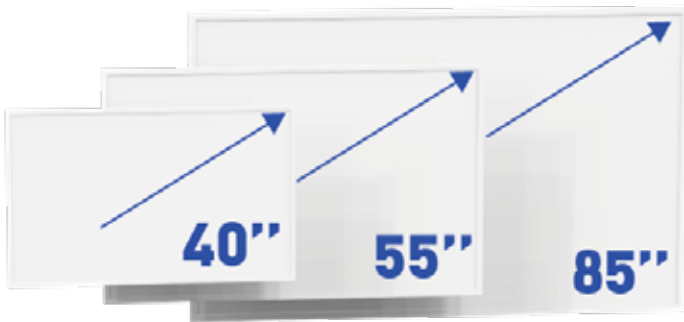

Because our TV screens are not all the same size...

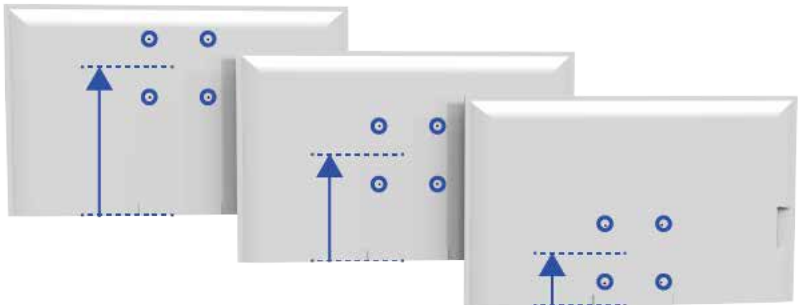

Because our TV mount patterns are not all positioned in the same place...

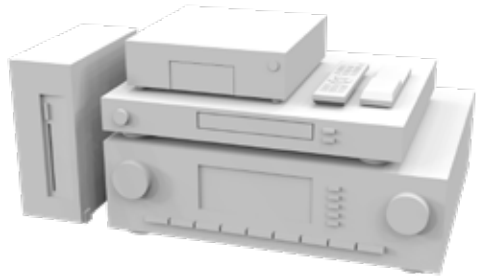

Because we sometimes have a lot of devices....

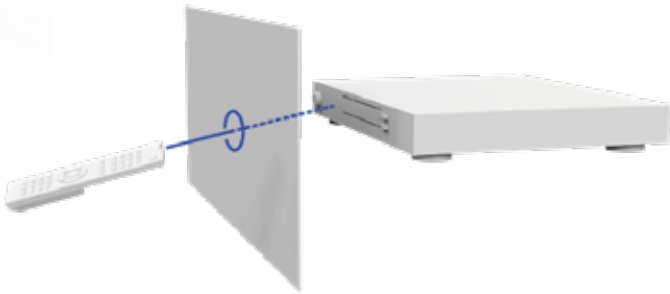

Because we need to pilot these devices....



Because we spend a lot of time charging our phones....



Because cables are always an issue...

# NAGA AND OUR SOLUTIONS...



Height adjustable feet  
386 or 450 mm



Large usable volume  
440 mm depth suitable for  
audio/video amplifiers



Gas springs  
and concealed hinges



Wide back openings  
for equipment ventilation



Cable management  
at the top of the cabinet

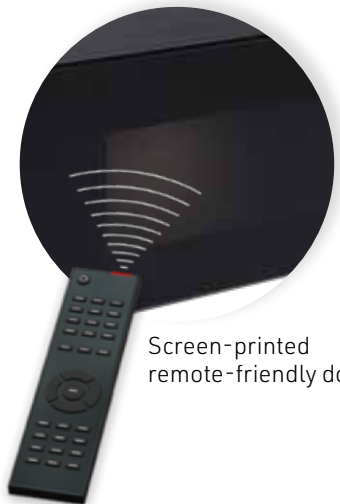

Screen-printed  
remote-friendly door



Technical compartment  
for power cable management



Hatch for power cable storage  
and management\*



Inductive Qi charging station  
for mobile phones \*\*  
Dimensions Ø68x28mm  
Power supply: DC 5V 2A  
Input: DC 5V 1.8A / Output: 5W  
Cable length: 1.5 m  
Wireless Power Certification  
Product also sold separately for integration  
in furniture:  
item no. 908900



Charger 4 USB \*\*  
Input: 100-240 VAC - 50/60 Hz  
Output 1~4 USB A : 5V / 2.4A (Smart IC)  
Smart IC function: Smart IC technology  
detects the charging needs of the devices  
connected to its USB ports (Smartphones,  
tablets...) and automatically delivers the  
output needed  
Product also sold separately: item no.  
908904

\* On all models

\*\* According to model

# NAGA 1400

## NAGA **1400** HATCH

Ref **037400 - Nordic** EAN 318528 037400 7

Ref **037410 - Carbon** EAN 318528 037410 6

### NAGA 1400 + HATCH



**L** 30"-65"  
76 - 165 cm



50 kg



Cable  
management

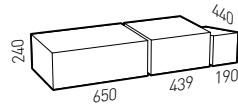
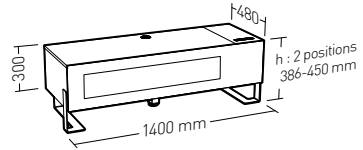

## NAGA **1400** Qi + USB

Ref **037401 - Nordic** EAN 318528 037401 4

Ref **037411 - Carbon** EAN 318528 037411 3

### NAGA 1400 + HATCH + Qi + 4 USB CHARGER



**L** 30"-65"  
76 - 165 cm



50 kg



Cable  
management

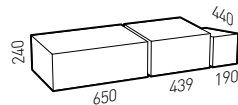
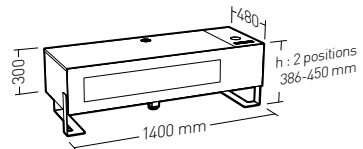

# NAGA 1600

## NAGA 1600 HATCH

Ref	<b>037600 - Nordic</b>	EAN 318528 037600 1
Ref	<b>037610 - Carbon</b>	EAN 318528 037610 0

NAGA 1600 + HATCH

**XL** 40"-85"  
101 - 216 cm

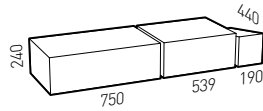
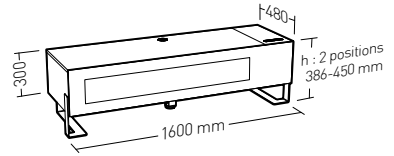

## NAGA 1600 Qi + USB

Ref	<b>037601 - Nordic</b>	EAN 318528 037601 8
Ref	<b>037611 - Carbon</b>	EAN 318528 037611 7

NAGA 1600 + HATCH + Qi + 4 USB CHARGER

**XL** 40"-85"  
101 - 216 cm

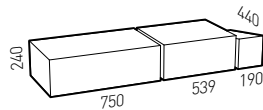
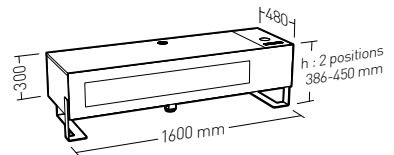
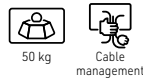

# NAGA 2000

**New** NAGA **2000** Qi + USB

Ref	<b>037001 - Nordic</b>	EAN 318528 037001 6
Ref	<b>037011 - Carbon</b>	EAN 318528 037011 5

NAGA 2000 + HATCH + Qi + 4 USB CHARGER



**XXL** 40"-100"  
101 - 228 cm



50 kg



Cable management

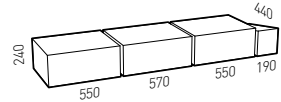
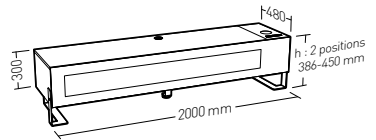

# NAGA COLUMN

## NAGA COLUMN XL

Ref 037900

EAN 318528 037900 2

NAGA COLUMN XL 40"-85"

**XL** 40"-85"  
101 - 215 cm



+/-10°



+/-20°



50 kg



Vesa  
100 > 600



Compat.  
Oled



Cable  
management



Screw Ø6  
Screw Ø8



Adapt+ kit  
included

- Screen height adjustable on 620 mm.
- Cable management in the column.
- Tilt and swivel TV bracket.

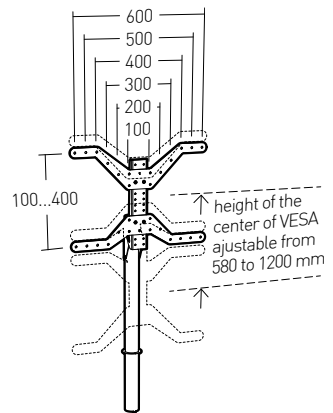

Adaptable to all NAGA models  
Column sold separately



Tilt and swivel TV  
bracket



Screen height  
adjustable on 620 mm



Cable management  
in the column



**Catalogues Supports et Meubles  
pour écrans plats**

Mounts and furniture for flat  
screens Catalogue  
Katalog Halterungen und Möbel für  
Flachbildschirme



**Catalogue Systèmes de fixations  
pour antennes et paraboles**

Mounting systems for antennas  
and satellite dishes Catalogue  
Katalog Befestigungssysteme für  
Antennen und Satellitenschüsseln



**Catalogue Systèmes de Connexion  
Grand Public et Professionnels**

Connection systems catalogue  
Katalog für Anschluss-Systeme



**Catalogue ERARD Pro**

ERARD Pro Catalogue  
Katalog Erard Pro

**ERARD®**

ESSENTIAL ACCESSORIES  
FOR AUDIO VIDEO COMPONENTS

Mail : [export@erard.fr](mailto:export@erard.fr) / [www.erard.com](http://www.erard.com) / Tel : +33 (0)4 72 46 16 26 / Fax : +33 (0)4 72 46 16 22

VAT N°: FR 81 403 591 415

Z.I. de Chavanoz / 4 route de la Plaine / 38230 CHAVANOZ / FRANCE

