

EMMA LED



EN Installation instructions
DE Montageanleitung
CZ Montážní návod
DK Monteringsvejledning
EE Paigaldusjuhend
FI Asennusohje
FR Notice de montage
HU Szerelési útmutat
HR Uputstvo za montažu
NL Montagehandleiding
RO Instructiuni de montaj

IT Istruzioni di montaggio
LT Montavimo instrukcijos
LV Instalācijas instrukcija
NO Monteringsanvisning
PL Instrukcja montażu
SE Installationsanvisning
RU Инструкция по монтажу
SRB Instrukcija za instalaciju
SK Montážny návod
SLO Navodilo za montažo
CN 安装说明书



1. Installation and commissioning may only be carried out by authorized specialists and wired in accordance with the latest IEE electrical regulations or the national standard.
2. Mains power must be switched off before carrying out installation.
3. The manufacturer shall not be liable for any damage resulting from inappropriate modifications to the luminaire or faulty installation.
4. Indoor use only.
5. Light source cannot be replaced.
6. Caution, risk of electric shock.
The control gear provides basic insulation between the LV supply and the control circuit.

| Product Description | Wattage | SAP Code | L(mm) | W(mm) | D(mm) |
|------------------------|---------|----------|-------|-------|-------|
| EMMA LED 1200 4000 840 | 35W | 96666098 | 1200 | 42 | 52.5 |
| EMMA LED 1500 6000 840 | 50W | 96666099 | 1500 | 42 | 52.5 |
| EMMA LED 1200 4000 830 | 35W | 96629750 | 1200 | 42 | 52.5 |
| EMMA LED 1500 6000 830 | 50W | 96629751 | 1500 | 42 | 52.5 |
| EMMA LED 600 2000 840 | 18W | 96666100 | 600 | 42 | 52.5 |
| EMMA LED 600 2000 830 | 18W | 96630322 | 600 | 42 | 52.5 |

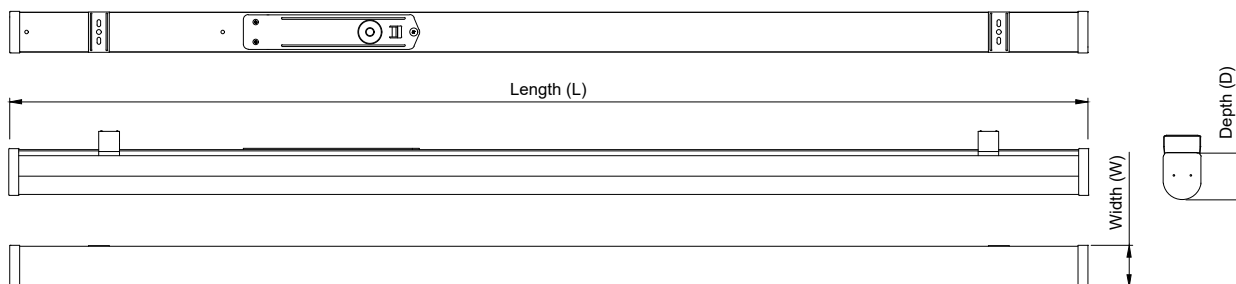

| | |
|---|----|
| 1 | x1 |
| 2 | x2 |
| 3 | x2 |
| 4 | x2 |
| 5 | x1 |

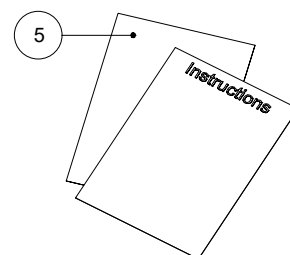
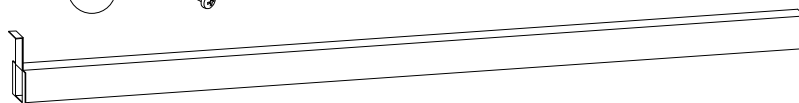
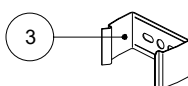
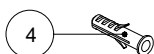

EMMA LED

1

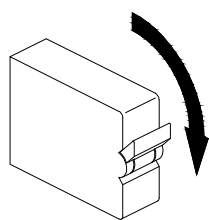

2

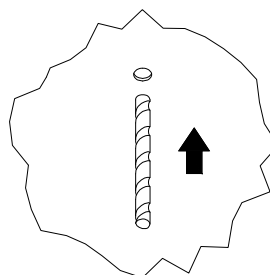
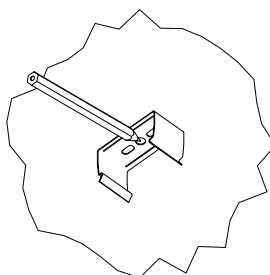

3

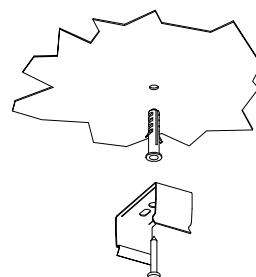
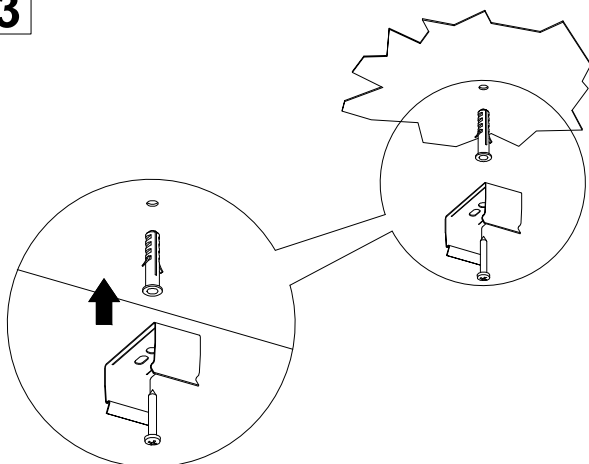

4

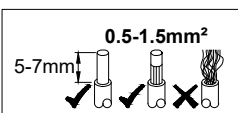
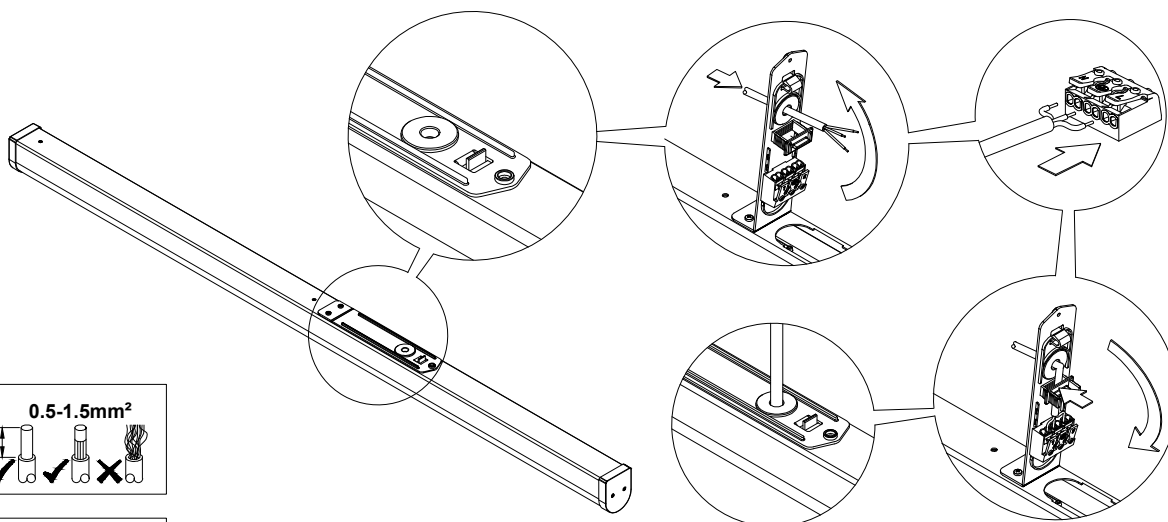

5

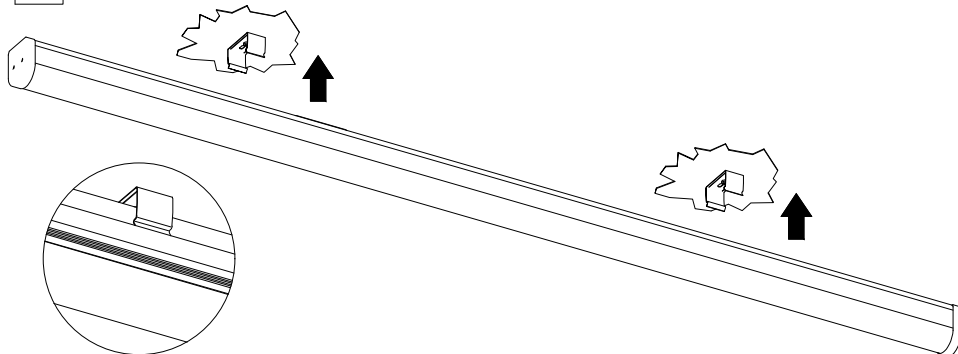

6

