

Z.I des Ajeux - 72400 La Ferté-Bernard - France
Tél. : +33 (0)2 43 60 40 00 / Fax : +33 (0)2 43 60 40 09

 www.securlite.com

Produit, caractéristiques techniques et fonctionnalités

Désignation	L	A	B	C
1/2x 1 LLC embouts plastiques	370	80	210	60
1/2x 1 LLC embouts alu	370	80	210	47
1/2x 1 LLC DPP embouts plastiques	435	80	275	60
1/2x 1 LLC DPP embouts alu	435	80	275	47
1/2x 2 LLC embouts plastiques	650	130	390	70
1/2x 2 LLC embouts alu	650	130	390	57
1/2x 2 LLC DPP embouts plastiques	715	130	455	70
1/2x 2 LLC DPP embouts alu	715	130	455	57
1/2x 3 LLC embouts plastiques	930	130	670	70
1/2x 3 LLC embouts alu	930	130	670	57
1/2x 3 LLC DPP embouts plastiques	995	130	735	70
1/2x 3 LLC DPP embouts alu	995	130	735	57
1/2x 4 LLC embouts plastiques	1210	130	950	70
1/2x 4 LLC embouts alu	1210	130	950	57
1/2x 4 LLC DPP embouts plastiques	1275	130	1015	70
1/2x 4 LLC DPP embouts alu	1275	130	1015	57

Kit d'installation standard:

Rondelle Caoutchouc x4.
Rondelle Métallique x4.

Caractéristiques générales:

Tension nominale: 220 - 240V AC – 50 / 60 Hz
Plage de tension d'entrée: 198 - 264V AC
Classe de protection: I
Indice de protection: IP65
Indice de résistance aux chocs mécaniques:
IK11 / 50j (embouts plastiques).
IK11++ / 150j (embouts métalliques).

Source lumineuse: LED - ce produit contient une source lumineuse de classe d'efficacité énergétique C.

Puissance(s): Se reporter à l'étiquette produit.

Référence(s): Se reporter à l'étiquette produit.

- Réf. générique: 65-66xxx00 sans détection (se reporter à cette notice).
- Réf. avec terminaison optionnelle (se reporter à la notice complémentaire).

Autre(s) référence(s) avec option(s):

- se reporter aux notices complémentaires.

Version angle :

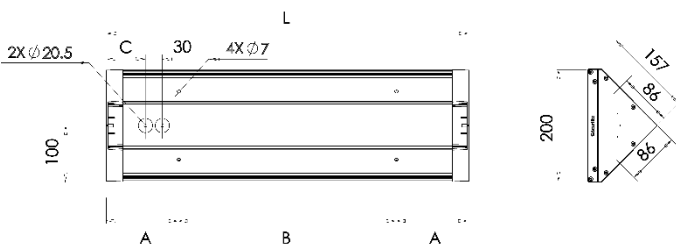

Version applique :

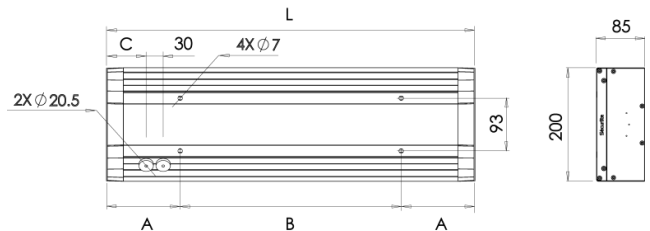

Conditions d'utilisation

Position Horizontale: OK (⚠) pour version angle installation dans un angle adjacent mur-plafond.

Position Verticale: OK (⚠) pour version angle installation dans un angle adjacent fermé mur-mur.

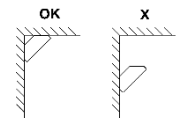

Montage / Installation

 Le montage et l'installation doit être fait par un installateur professionnel en respectant les normes d'installation en vigueur.

 Couper l'alimentation avant la pose et le branchement.

 Attention, risque de chocs ESD sur les LEDs.

Ouverture luminaire:

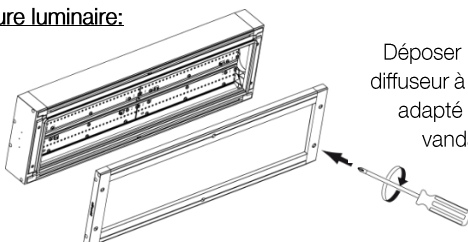

Déposer l'ensemble cadre + diffuseur à l'aide d'un tournevis adapté et de l'insert anti-vandale 98000003.

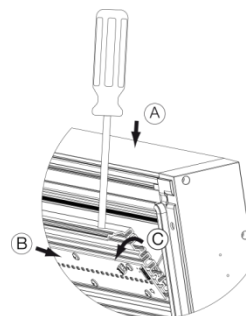

A – introduire un tournevis à tête plate dans l'interstice prévu entre les profilés aluminium.

B+C – Faire lever tous les 20-30 cm afin de déclipser la platine.

Fixation:

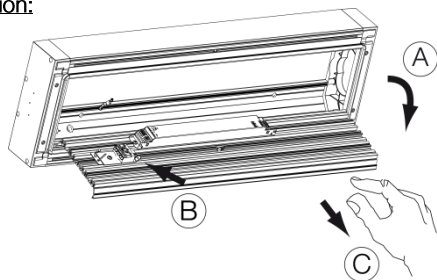

- A – Faire pivoter la platine.
- B – Déconnecter le câble de terre du support connecteur.
- C – Retirer la platine.

Raccordement électrique:

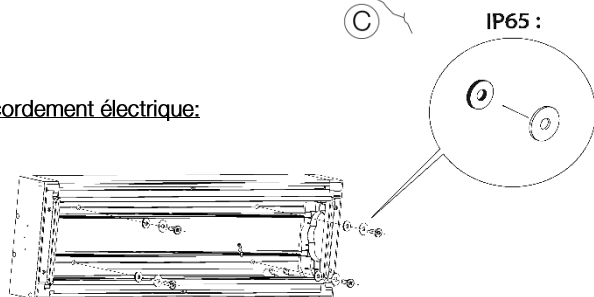

Pour la fixation du luminaire, utiliser des vis de diamètre 5mm à tête plate et des chevilles adaptées au type de paroi pour avoir une résistance optimale à l'arrachement. Les vis et chevilles ne sont pas fournies avec le luminaire. Utiliser les rondelles caoutchouc + rondelles métalliques afin de respecter l'étanchéité.

Raccordement électrique classe 1 (Réf. Générique : 65-66xxxx00):

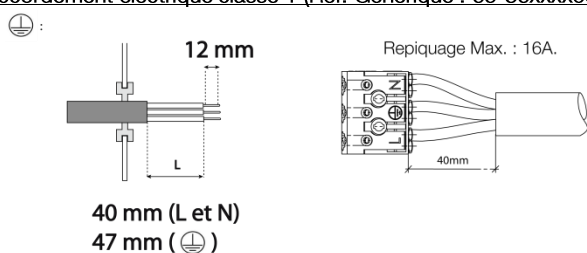

Le câble devra être dénudé selon schémas. Respecter la polarité.

- Pour autres cas, se reporter aux notices particulières pour raccordement et repiquage.

Fermeture du luminaire:

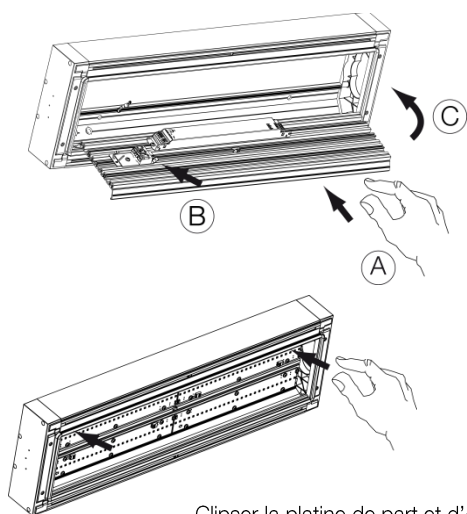

- A – Insérer la platine.
- B – Connecter le câble de terre au support connecteur.
- C – Faire pivoter la platine.

Clipser la platine de part et d'autre du luminaire.

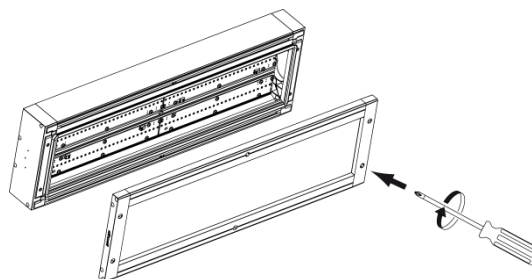

Refermer l'ensemble cadre + diffuseur à l'aide d'un tournevis adapté et de l'insert anti-vandale 98000003.

Entretien

L'entretien du luminaire se limite à un nettoyage du diffuseur pour une bonne luminosité, nettoyer le diffuseur (luminaire fermé) avec un chiffon humide ou à l'eau savonneuse.

 **NE PAS UTILISER DE DETERGENT**

Maintenance

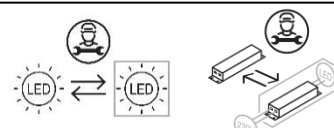

La source lumineuse et l'appareillage contenus dans ce luminaire ne doivent être remplacés que par le fabricant, son agent de service ou une personne de qualification équivalente.

Recyclabilité



La gamme URBALINE est une gamme de luminaire éco-conçue:

- Toutes les pièces plastiques ou métalliques peuvent être démontées et recyclées dans une filière adaptée.
- Tous les composants électroniques tels que le circuit LED, l'alimentation, etc ... peuvent être démontés et recyclés dans une filière adaptée.

Z.I des Ajeux - 72400 La Ferté-Bernard - France
Tél. : +33 (0)2 43 60 40 00 / Fax : +33 (0)2 43 60 40 09

 www.securlite.com

Product, technical characteristics and features

Désignation	L	A	B	C
1/2x 1 LLC plastic end caps	370	80	210	60
1/2x 1 LLC metal end caps	370	80	210	47
1/2x 1 LLC DPP plastic end caps	435	80	275	60
1/2x 1 LLC DPP metal end caps	435	80	275	47
1/2x 2 LLC plastic end caps	650	130	390	70
1/2x 2 LLC metal end caps	650	130	390	57
1/2x 2 LLC DPP plastic end caps	715	130	455	70
1/2x 2 LLC DPP metal end caps	715	130	455	57
1/2x 3 LLC plastic end caps	930	130	670	70
1/2x 3 LLC metal end caps	930	130	670	57
1/2x 3 LLC DPP plastic end caps	995	130	735	70
1/2x 3 LLC DPP metal end caps	995	130	735	57
1/2x 4 LLC plastic end caps	1210	130	950	70
1/2x 4 LLC metal end caps	1210	130	950	57
1/2x 4 LLC DPP plastic end caps	1275	130	1015	70
1/2x 4 LLC DPP metal end caps	1275	130	1015	57

Standard installation kit:

Rubber washer x4
Metallic washer x4

General characteristics:

Nominal voltage: 220 - 240V AC – 50 / 60 Hz
Input voltage range: 198 - 264V AC
Protection class: I
Protection rating: IP65
Mechanical impact resistance rating:
IK11 / 50 j (plastic end caps).
IK11++ / 150 j (metallic end caps).

Light source: LED - this product contains a light source of energy efficiency class C.

Power(s): as per label product.

Reference(s): as per label product.

- Standard reference: 65-66xxx00 no detection (see this instruction).
- Options regarding the end of product's reference (see specific instructions).

Other reference(s) with option(s):

- See specific instructions.

Angle version :

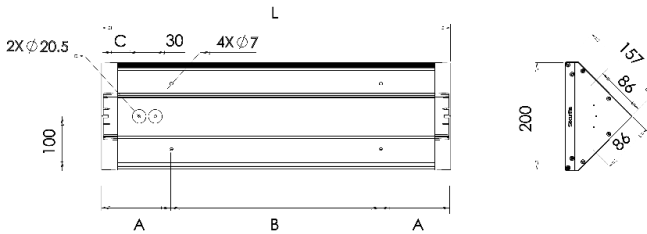

Wall mounted version :

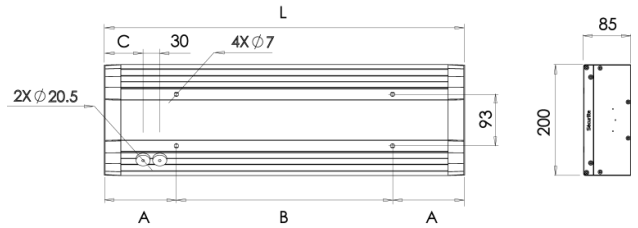

Conditions of use

Horizontal position: OK  Horizontal position: for angle version installation in the corner between wall and ceiling.

Vertical position: OK  Vertical position: for angle version installation in a corner between two walls.

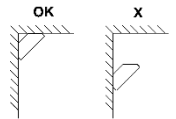

Mounting / Installation

 Fitting & installation must be carried out by a professional installer in accordance with current installation standards.

 Isolate the power before fitting and connecting up.

 Warning, versions employing LEDs are at risk from ESD (electrostatic discharges).

Opening the luminaire:

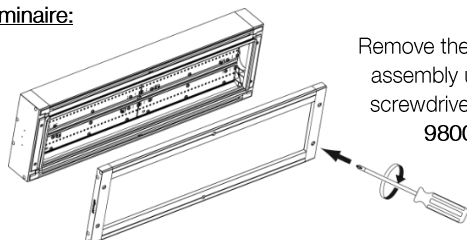

Remove the frame + diffuser assembly using a suitable screwdriver fitted with the 98000003 bit

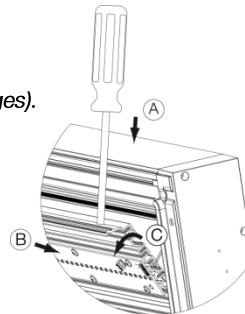

A – Insert a flat-bladed screwdriver into the gap between the aluminium profiles.

B+C – Use the screwdriver as a lever every 20-30 cm to unclip the geartray.

Fixing:

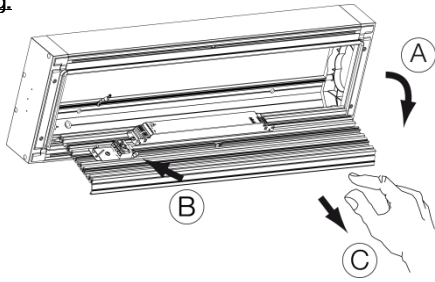

- A – Turn the geartray.
- B – Disconnect the earth cable from the holder connector.
- C – Remove the geartray.

Electrical connection:

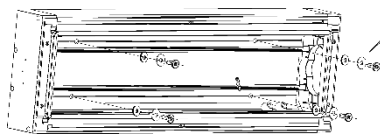

IP65 :

For mounting the luminaire, use 5 mm diameter flat-headed screws with fixing plugs suitable for the type of wall, in order to achieve optimum rip-out resistance. The screws and plugs are not supplied with the luminaire. Use the rubber and metallic washer in order to maintain the sealing of the product. Use the pre-drilled holes to fix the luminaire.

Preparing the cable entry grommet class 1 (Standard reference 65-66xxx00):

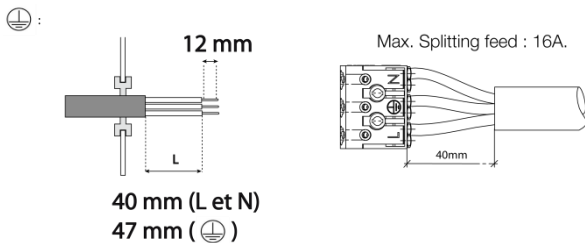

The cable must be prepared as per the diagrams. Respect the polarity.

- For other cases, refer to the specific instructions for connection and splitting off.

Closing the luminaire:

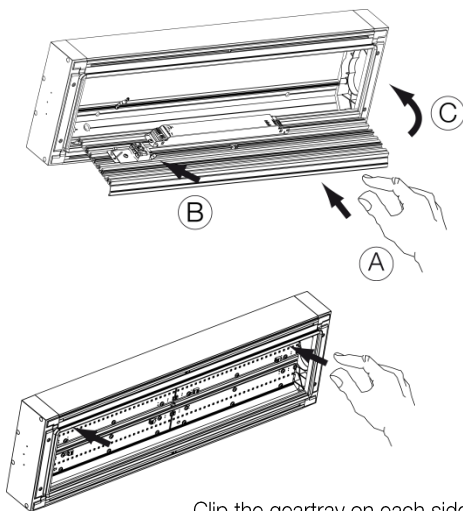

- A – Insert the geartray.
- B – Connect the earth cable to the holder connector.
- C – Turn the geartray.

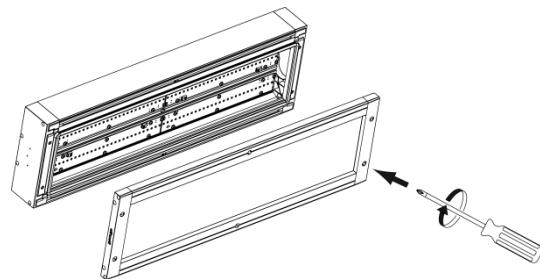

Clip the geartray on each side of the luminaire.

Refit the frame + diffuser assembly using a suitable screwdriver fitted with the 98000003 vandal-resistant bit.

Cleaning

Cleaning of the luminaire is limited to cleaning the diffuser for proper light output. Clean the diffuser (luminaire must be closed) using a damp cloth or with soapy water.

 **DO NOT USE DETERGENT**

Maintenance

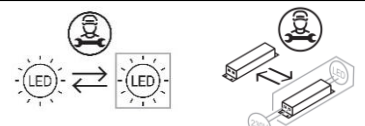

 The light source and the control gear contained in this luminaire must only be replaced by the manufacturer or his service agent or a similar qualified person.

Recyclability



The URBALINE is an eco-designed luminaire:

- All the plastic or metal components can be dismantled and recycled via appropriate facilities.
- All the electronic components such as the LED circuit, power supply, etc. can be dismantled and recycled via appropriate facilities.