



**BOSCH**

# **Access Modular Controller 2**

API-AMC2-16ION

**en**      Installation manual



## Table of contents

<b>1</b>	<b>Safety Instructions</b>	<b>4</b>
1.1	Important safety notes	4
1.2	Safety precautions	5
1.3	Unpacking	6
<b>2</b>	<b>Important Information</b>	<b>7</b>
2.1	Explanation of symbols in this document	7
2.2	Internet	7
<b>3</b>	<b>Introduction</b>	<b>8</b>
3.1	Description	8
3.2	Equipment Configuration	8
3.3	Performance Characteristics	11
3.4	System Overview	11
<b>4</b>	<b>Installing</b>	<b>13</b>
4.1	Mounting	13
4.2	Unmounting	14
4.3	Opening the Case	15
4.4	Closing the Case	16
4.5	Cabling	16
4.5.1	Conductor data for power to AMC2	16
4.6	Grounding and Shielding	18
4.6.1	Grounding for Host Interface	18
4.6.2	Grounding for Extension Interface	19
4.7	Connecting Power Supply	20
4.8	Ethernet Host Interface	21
4.9	RS-485 Host Interface	22
4.9.1	RS-485 Two Wire Connection	23
4.9.2	RS-485 Four Wire Connection	23
4.10	RS-232 Host Interface	24
4.11	DIL switch selector	25
4.11.1	Host settings	25
4.11.2	Board Settings	26
4.12	RS-485 for extension modules	26
4.13	Connecting Relay Outputs	28
4.14	Connecting Analog Input Devices	31
4.15	Tamper Protection	33
<b>5</b>	<b>Operating</b>	<b>34</b>
5.1	Status Display of the AMC2	34
5.2	Configuring the Ethernet Interface	36
5.3	Troubleshooting	36
5.3.1	Resetting the Software	36
5.3.2	Resetting the Device to Factory Default	37
<b>6</b>	<b>Technical Data</b>	<b>38</b>
<b>7</b>	<b>Appendices</b>	<b>41</b>
7.1	Connecting Diagrams	41
	<b>Index</b>	<b>45</b>

# 1 Safety Instructions

## 1.1 Important safety notes

1. **Read, follow, and retain instructions** - All safety and operating instructions must be read and followed properly before putting the unit into operation. Retain instructions for future reference.
2. **Do not ignore warnings** - Adhere to all warnings on the unit and in the operating instructions.
3. **Accessories** - Use only accessories recommended by the manufacturer or those sold with the product. Accessories not recommended by the manufacturer must not be used, as they may cause hazards.
4. **Installation precautions** - Do not place this unit on an unstable stand, tripod, bracket, or mount. The unit may fall, causing serious injury to persons and damage to the unit. Mount the unit according to the manufacturer's instructions.
5. **Service** - Do not attempt to service this unit by yourself. Opening or removing covers may expose you to dangerous voltages or other hazards. Refer all servicing to qualified service personnel.
6. **Damage which requires service** - Disconnect the unit from the main AC or DC power source and refer servicing to qualified service personnel under the following conditions:
  - If the power supply cord or plug is damaged.
  - If liquid has been spilled or an object has fallen into the unit.
  - If the unit has been exposed to water and/or inclement weather (rain, snow, etc.).
  - If the unit does not operate normally when following the operating instructions. Adjust only those controls specified in the operating instructions. Improper adjustment of other controls may result in damage, and require extensive work by a qualified technician to restore the unit to normal operation.
  - If the unit has been dropped or the cabinet damaged.
  - If the unit exhibits a distinct change in performance.
7. **Replacement parts** - If replacement parts are required, the service technician must use only replacement parts that are specified by the manufacturer. Unauthorized replacements may result in fire, electrical shock or other hazards.
8. **Safety check** - Upon completion of service or repair work on the unit, ask the service technician to perform safety checks to ensure that the unit operates properly
9. **Power sources** - Operate the unit only from the type of power source indicated on the label. If unsure of the type of power supply to use, contact your dealer
10. **Lightning** - For added protection during electrical storms external lightning conductors can be installed. This prevents power surges from damaging the unit.
11. The units should be installed in **locations with restricted access**.

## 1.2 Safety precautions

### Read the instructions

Before working with the AMC2 device, read these instructions carefully. Make sure you have understood all information described in this document.



### Warning!

#### Risk of electric shock

External power supplies must be installed and put into service by qualified personnel. Ensure compliance with the relevant regulations. Ground the controller. Disconnect both AC and battery power supply before working on the controller.



### Warning!

#### Risk of fire

Installation of the AMC2 device must comply with any local fire, health, and safety regulations. A secured door that may be part of an escape route from an area must be installed with:  
Install a fail-safe lock (A), so that the door will be released if power fails. Ideally, use a magnetic lock.  
Install a normally-closed break glass or a manual pull (B) in the lock supply wiring, so that in an emergency the fail-safe lock can be immediately powered down.



### Warning!

#### Risk of explosion of Lithium battery

The battery can explode if it is replaced incorrectly. Replace only with the same type as recommended by the manufacturer. Dispose used batteries according to the battery manufacturer’s instructions.



### Notice!

#### Risk of damage to equipment

Protect the hardware from electrostatic discharge by observing ESD instructions before unpacking of touching connectors of electronics. Always switch off power of the AMC2 device before modifying the installation. Do not connect or disconnect plug connectors, data cables, or screw connectors while power is on.

### Rules and Conditions

There are no specific requirements as for selling and delivery. As for storage and safe operation, the environmental temperature should not exceed the range of 0°C to 50°C.

### Disposal

Your Bosch product is designed and manufactured with high-quality materials and components which can be recycled and reused.



This symbol means that electrical and electronic equipment, at their end-of-life, should be disposed of separately from your household waste.

In the European Union, there are separate collection systems for used electrical and electronic products. Please dispose of this equipment at your local community waste collection/recycling center.

## 1.3 Unpacking

Check the packaging for visible damage. If anything has been damaged during transport, please inform the transport agency.

Unpack the unit carefully. This is an electronic device that must be handled with care to avoid damage. Do not attempt to put the unit into operation if components are damaged.

If any parts are missing, inform your customer service representative or a Bosch Security Systems salesperson. The shipping carton is the safest transport container for the unit. Store it and the other packaging material for future use. If the unit has to be sent back, use the original packaging.

## 2 Important Information

### Remarks

This hardware is part of a security system. Access should be limited to authorized persons only.

Some states do not allow the exclusion or limitation of implied warranties, or limitation of liability for incidental or consequential damages, hence the above limitation or exclusion might not apply to you.

Bosch Security Systems retains all rights not expressly granted. Nothing in this license constitutes a waiver of Bosch's rights under the U.S. Copyright laws or any other federal or state law.

If you have any questions concerning this license, please, write to:

Bosch Sicherheitssysteme GmbH  
Robert-Bosch-Ring 5  
85630 Grasbrunn  
Germany.

### 2.1 Explanation of symbols in this document

Throughout this document, warning messages, important notes, and helpful tips are presented for the reader. These appear as follows:



#### **Danger!**

Cause of Hazard

Indicates a hazardous situation, which, if not avoided, will result in death or serious injury.

---



#### **Warning!**

Cause of Hazard

Indicates a hazardous situation, which, if not avoided, could result in death or serious injury.

---



#### **Caution!**

Cause of Hazard

Indicates a hazardous situation, which, if not avoided, could result in minor or moderate injury.

---



#### **Notice!**

Cause of Hazard

Important Notes that must be followed to avoid damage to the equipment or environment, and to ensure successful operation and programming.

Tips and shortcuts may also be included in such notes.

---

### 2.2 Internet

If you are interested in further information on this product or information on other products, please consult our website at <http://www.boschsecurity.com>.

### 3 Introduction

#### 3.1 Description

The AMC2-16ION board provides inputs and outputs to control doors and other components independent of access control system.

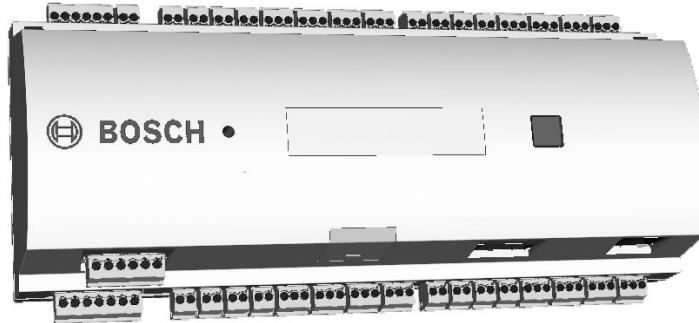

Figure 3.1: The IO-Controller AMC2-16ION

The AMC2-4R4 standalone board (hereafter also referred as AMC2 or controller) are deployed via a dedicated OPC-Server. Though similar in appearance to the AMC2-4W and AMC2-4R4 controllers, the AMC2-4R4 has no reader interfaces, but is intended instead for the efficient monitoring and control of many devices, especially entrances, simultaneously. It is not an extension board like the AMC2-16IOE, AMC2-8IOE, and AMC2-16IE but possesses its own CPU and host interfaces.

The AMC2-4R4 has 16 analog inputs and 16 relay outputs. Via its inputs the module can determine the status (e.g. locked, closed or open) of entrances, windows or other devices, and its output signals can lock/unlock doors, or trigger alarms with external monitoring systems in the case of an intrusion.

If the 8 and the 8 outputs are insufficient for your needs, then up to three extensions (AMC2-16IOE , AMC2-8IOE, or AMC2-16IE) can be connected, thus providing the AMC2-4R4 with a maximum of 64 inputs and 64 outputs for configuration.

#### 3.2 Equipment Configuration

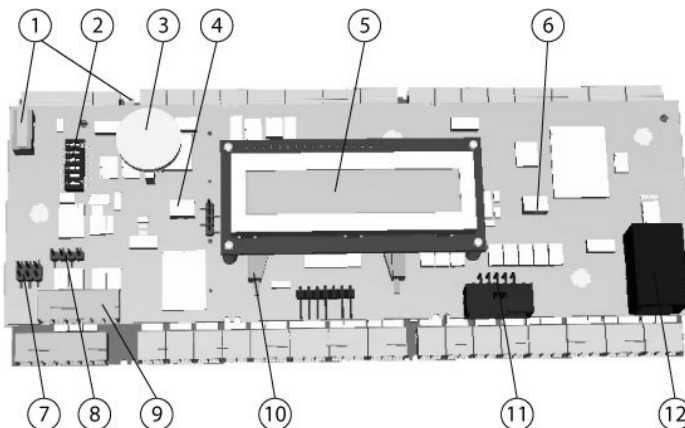

Figure 3.2: Circuit board with display (top side)

1	(N.A.)
2	DIL switch for RS-485 address selection , protocol, and RS-232/RS-485 selection.



<b>3</b>	Lithium battery for buffering of static RAM and real time clock (RTC). The battery life is estimated at 10 years, nevertheless an error message is generated if the voltage sinks below a preset minimum level. <b>NOTICE:</b> In order to avoid an error message caused by an earlier voltage drop we suggest to replace the battery every 8 years. <b>Spare part: VARTA CR 2032 PCB.</b>
<b>4</b>	Reset push button - reachable through the casing using a screwdriver
<b>5</b>	Liquid Crystal Display
<b>6</b>	Push button, available on top of the housing, to select different display modes
<b>7</b>	Jumper: Equalization of potential between different systems and earth ground (shield)
<b>8</b>	Jumper: Interface selector RS-485 host connection, RS-485 two wire or RS-485 four wire (depends on external wiring)
<b>9</b>	Configurable RS-485 host interface
<b>10</b>	Docking port for compact flash memory
<b>11</b>	Configurable RS-232 host interface (ribbon cable connector)
<b>12</b>	Configurable 10/100 Mbit/s Ethernet host interface

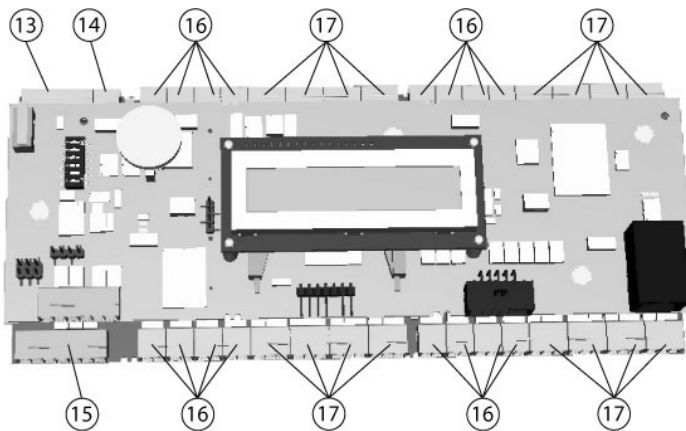

Figure 3.3: Overview - Interfaces

<b>13</b>	RS-485 extension module bus
<b>14</b>	External tamper contact
<b>15</b>	Connector for power supply
<b>16</b>	Connectors for eight analog inputs
<b>17</b>	Connectors for eight relay outputs



**Notice!**

All connectors, with the exception of the RS-232 and Ethernet host interface, are pluggable screw clamp terminals.

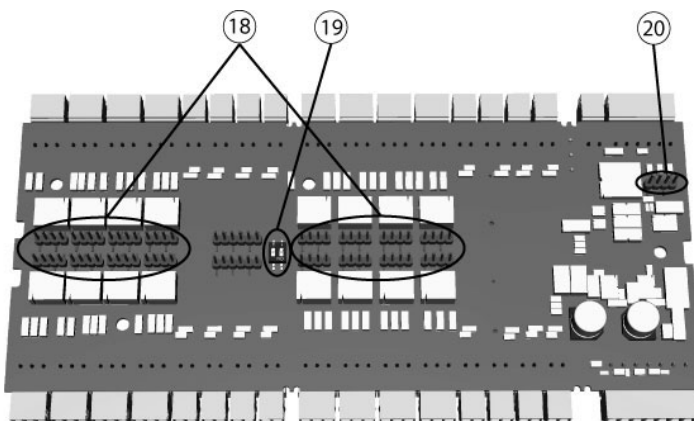

**Figure 3.4: Jumpers at the bottom side**

<b>18</b>	Jumper for setting either voltage free relay output (“dry” mode) or looped-in voltage from the AMC2 internal power supply (“wet” mode).
<b>19</b>	DIL switch for setting the board address.
<b>20</b>	Jumper: Equalization of potential between different systems and earth ground (shield) for the extension interface.



**Notice!**

For details on the setting of the jumpers and DIL switches listed here, please see *DIL switch selector*, page 25.

### 3.3 Performance Characteristics

- Host address selectable using DIL sliding switch.
- Four possible configurable host interfaces:
  - Ethernet (= standard)
  - RS-485 2-wire
  - RS-485 4-wire
  - RS-232
- Eight relay outputs
  - voltage free, power is supplied externally (dry mode)
  - powered by internal power supply (wet mode)
- Eight analog inputs with internal power supply
- Battery buffered SRAM and real time clock (RTC)
- Pluggable Compact Flash card
- Liquid Crystal Display
- Transfer rate host interface RS-485: 38,4 kBit/s
- Transfer rate host interface RS-232: 38,4 kBit/s
- Transfer rate host interface Ethernet: 10/100 Mbit/s
- Transfer rate to the extension interface: 9,6 kBit/s
- Self regulating transmit/receive switching
- Supply voltage: 10 V to 14 Vdc,
- Max current load: 3A
- Tamper contact for external covers



#### Notice!

If an external power supply is used, this should also guarantee an uninterruptable power supply (UPS). Example: Bosch power supply APS-PSU-60 (F.01U.282.970).

### 3.4 System Overview

The AMC2-4R4 is deployed as an independent controller between the management host system and various peripheral devices. By default, a management host system is connected via Ethernet. A management host connection using RS-485 or RS-232 is also possible.

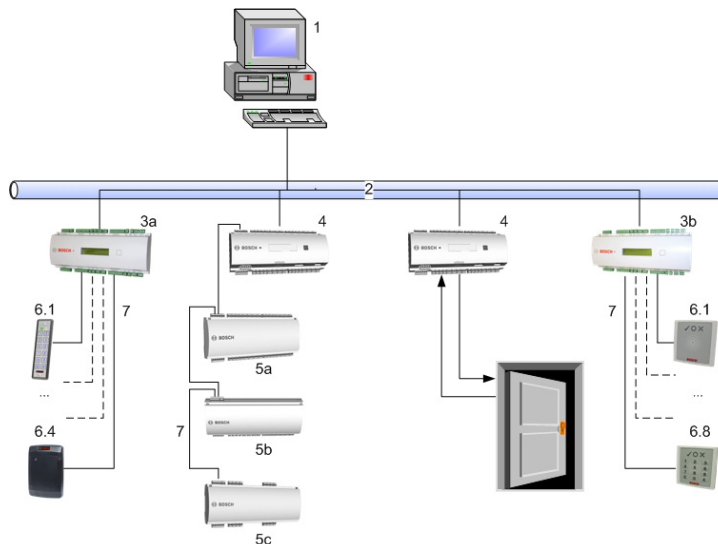

Figure 3.5: System overview

1 =		Host
2 =		Ethernet
3 =		Access Controller
	a =	AMC2-4W
	b =	AMC2-4R4
4 =		AMC2-16ION
5 =		I/O-Extensionboards
	a =	AMC2-16IOE
	b =	AMC2-8IOE
	c =	AMC2-16IE
6 =		Card reader
7 =		Communication and power supply

Depending on the kind of interface are available the following constellations are possible:

- Using RS-232 host connection one AMC2-4R4 can be connected per COM port.
- Using RS-485 host connection, up to eight of these modules can be combined on one COM port.
- Up to three extension boards can be connected to and controlled by the AMC2-4R4. These can be any combination of types AMC2-8IOE, AMC2-16IOE, or AMC2-16IE.

System configurations for Access Control applications.

- The minimum configuration consists of:
  - one PC with system software,
  - one AMC2 controller,
  - one AMC power supply,
  - one AMC enclosure.
- The maximum configuration depends on the system software,

## 4

### 4.1 Installing Mounting

The AMC2-4R4 can be attached on a standard 35 mm (1.377 in.) mounting rail using a snap-in mechanism. Attach the AMC2-4R4 into the upper edge of the mounting rail [1], then push down the device and snap it onto the rail by pushing it towards the back [2].

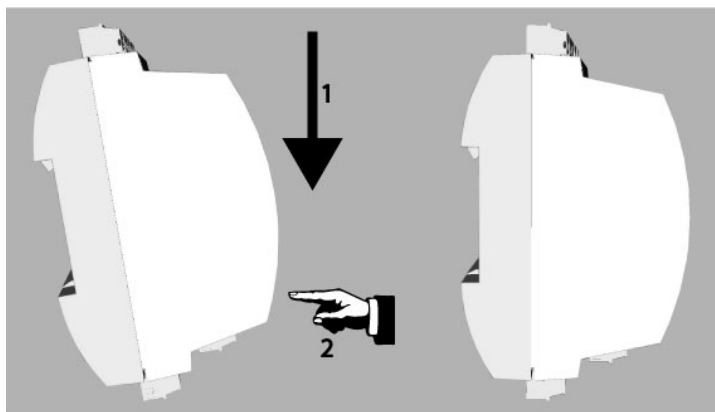

Figure 4.1: Mounting the AMC2 on a mounting rail

## 4.2 Unmounting

**Notice!**

To remove the AMC2-4R4 from a mounting rail, first remove all pluggable connectors.

Push down the AMC2-4R4 until the lower edge snaps out of the mounting rail [1]. Pull the lower end of the AMC2-4R4 from the mounting rail [2].

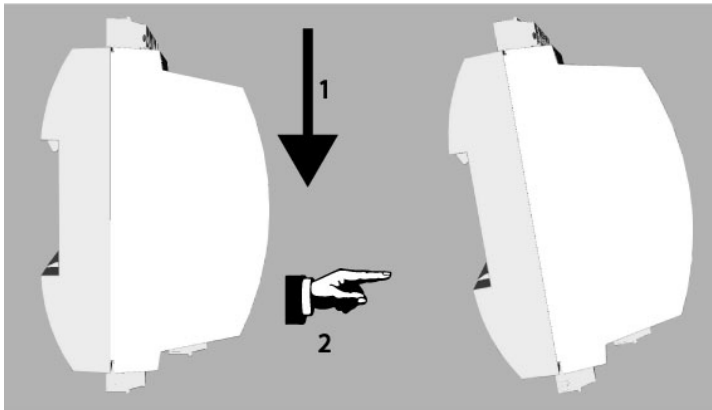

Figure 4.2: Unmounting the AMC2 from a mounting rail

## 4.3 Opening the Case



### Notice!

To open the AMC2-4R4, first remove all pluggable connectors.

The AMC2-4R4 case consists of a top cover mounted with a two-point snap-in closure on a chassis. To open the case, push down the two snap-ins with a screwdriver, then swing the cover down.

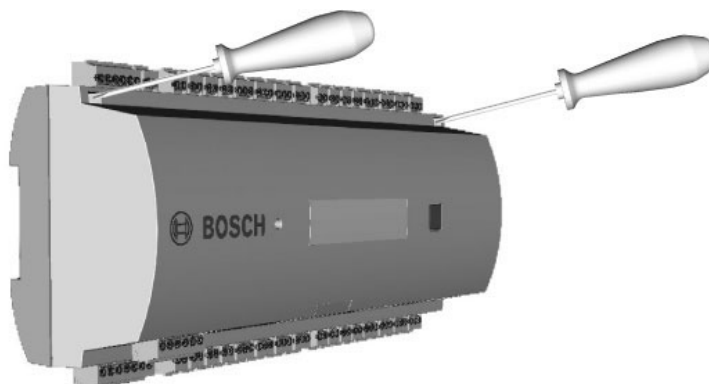

Figure 4.3: Opening the AMC2-16ION case

## 4.4 Closing the Case

Before aligning the covers, unplug any pluggable screw connectors. Insert the hooks on the lower edge of the front cover into the lugs on lower edge of the plastic back cover [1]. Please ensure that the BOSCH logo is not upside-down. The upper edge of the front cover now aligns with the two-point snap-in closures on the upper edge of the back cover [2], and may thus be clicked gently into place.

Hence the closing process is the reverse of the opening process.

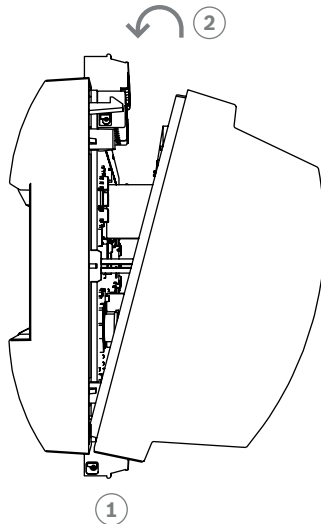

Figure 4.4: Closing the case



### Notice!

Risk of damage to equipment

If excessive force is required to close the front cover then it is probably incorrectly hooked into the back cover. In such cases the display 'Dialog' button in the front cover will be misaligned and will not function correctly.

## 4.5 Cabling

### 4.5.1 Conductor data for power to AMC2

With the calculation below you can find out which cable type must be used. If you connect the power supply and the AMC-device with the delivered cable set from the enclosure the calculation is not necessary.

For distances below 25 m (75 ft) use AWG18 conductors (1mm<sup>2</sup>). For longer distances, install an additional power supply close to the AMC2 controller.

Please, calculate the voltage drop by checking the conductor specifications for characteristic resistance values. The voltage drop shall not exceed 2 V.

Example:

Length = 100 m/328 ft

U = 12V, I = 1A, maximum U<sub>Drop</sub> = 2V

i.e. RAWG18 (acc. specs) = 6.385  $\frac{\Omega}{1000 \text{ ft}}$  or 20,948  $\frac{\Omega}{\text{km}}$

U<sub>Drop</sub> = 20,948  $\frac{\Omega}{\text{km}}$  x 0.1 km x 1A = 2.1V

U<sub>Drop</sub> = 6.385  $\frac{\Omega}{1000 \text{ ft}}$  x 328 ft x 1A = 2.1V

Critical condition! Install the power supply closer to the controller.



**Notice!**

These specifications apply to power supply, readers, relay outputs, and extension interface. Regarding inputs, specific voltage-drop values need to be taken into account. Refer to *Connecting Analog Input Devices, page 31*.

---

## 4.6 Grounding and Shielding

The main grounding point at the AMC2-4R4 is connected to pin 2 of the power supply connector - see *Connecting Diagrams, page 41*.

It is good practice to shield all wires carrying low level signals.

The AMC2-4R4 allows you to create a central ground or shielding point, simply by setting certain jumpers. Set these jumpers only if grounding or shielding is not achieved by other means.



### Notice!

Risk of malfunction  
Ensure that no ground loops are formed.



### Notice!

In general the following apply:  
If the devices have their own power supplies, the shielding is applied to one side only. The free end should be insulated to avoid inadvertent connections.  
If one device is fed power by another, the cable shielding should be applied to both sides.

### 4.6.1 Grounding for Host Interface

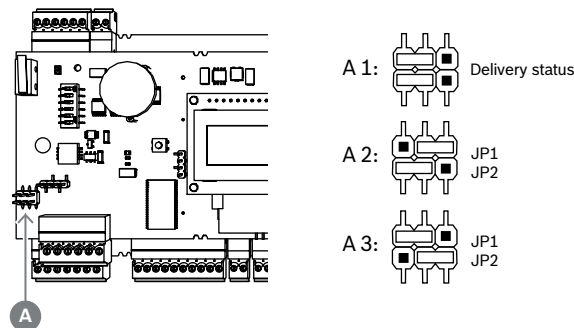

**Figure 4.5: Location of ground jumper RS-485 host interface**

The jumper setting A1 shows the factory settings.

Jumper JP1 connects the internal ground of the AMC2-4R4 to the ground of the RS-485 host interface.

Jumper JP2 manages the signal ground.

Settings for jumper JP1:

If the ground conductor and the shield on the host are not connected and:

- no party line exists, the jumper JP1 is set (= A2)
- a party line exists, the jumper JP1 is set at the first device only (= A2)

Settings for jumper JP2:

If the ground conductor and the shield on the host are not connected and:

- no party line exists, the jumper JP2 is set (= A3)
- a party line exists and signal ground is connected, the jumper JP2 is set at the first device only (= A3)

- a party line exists and signal ground is not connected, the jumper JP2 is set at all devices (= A3)

### 4.6.2 Grounding for Extension Interface

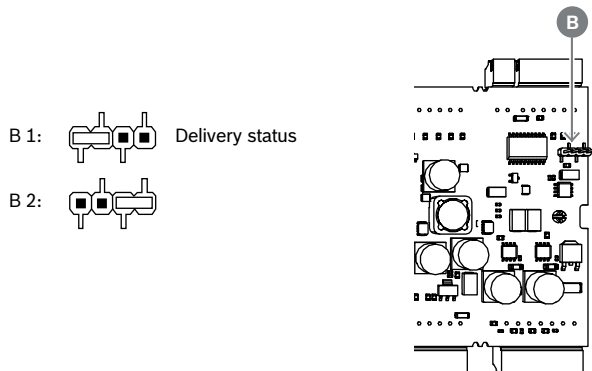
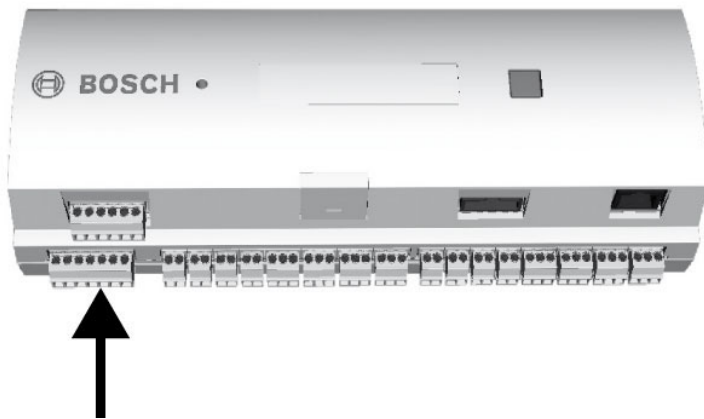

**Figure 4.6: Location of ground jumper bottom side**

Jumper B connects the internal ground of the AMC2-4R4 to the RS-485 ground of the slave interface. Only set jumper B (B2) if the AMC2-4R4 powers all other peripheral devices directly connected to it.

## 4.7 Connecting Power Supply

Connect the power supply to the POWER 7-pin pluggable screw connector. Refer to *Connecting Diagrams, page 41* for a complete diagram of the power supply connector.



**Figure 4.7: Location of the power supply connector**

Connect an external power supply (10 - 14 Vdc) for the AMC2 device at pin 1 (positive) and pin 3 (0 V) of the pluggable screw connector.

If an uninterruptible power supply (UPS) is used, the relay output for power good signals from the UPS is connected to the following pins:

- pin 4 and 7 for power good AC
- pin 5 and 7 for power good Battery
- pin 6 and 7 for power good DC

Otherwise these pins must be short-circuited.



### Notice!

The battery status is checked every 5 minutes by the power supply unit (APS-PBC-60 or APS-PSU-60).

As the battery charging/discharging levels tend to vary, the AMC2 provides information about the battery status every 10 minutes. This feature allows a more reliable battery status information.

---

## 4.8 Ethernet Host Interface

The AMC2-4R4 offers a 10/100 Mbit/s Ethernet auto-sensing interface to connect to a local area network or host computer.

A complete connection diagram of the Ethernet host interface is shown in chapter *Connecting Diagrams*, page 41.



### Notice!

After connecting a new AMC2 device to a network using DHCP, it can take some time before the new AMC2 device is recognized by the remote server.

You can accelerate this process by running the following command:

```
ipconfig /flushdns
```

This makes the AMC2 device immediately available by its name.

---

## 4.9 RS-485 Host Interface

An RS-485 host system can consist of up to eight AMC2 controllers connected using 2- or 4-wire connection.

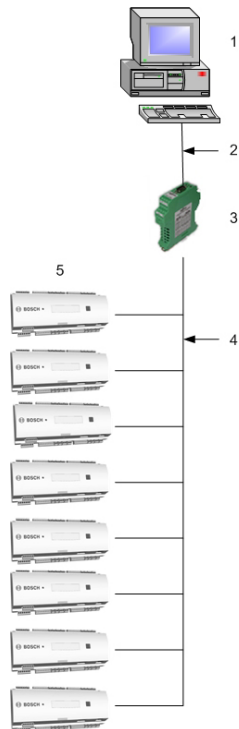

**Figure 4.8: Configuration of a RS-485 host system**

1 =	Host
2 =	RS-232 connection
3 =	RS-232 / RS-485 converter
4 =	RS-485 bus
5 =	AMC2 controller

The following conditions apply for an RS-485 bus system:

- A bus system consists of a bus line and/or one or more branch lines.
- Cable lengths exceeding 100 m (300 ft) must be installed as bus lines.
- Branch lines are branching connections from a bus line.
- Peripheral devices are AMC2 which are connected to the host computer.
- Maximum cable length of a bus line must not exceed 1200 m (4000ft).
- The cable length of branch lines must not exceed 100m (330ft).
- Any bus line conductor connects up to eight AMC2. Do not exceed the maximum number of devices.

To use RS-485 mode at the AMC2-4R4 , connect the data cables to the pluggable screw connector of the RS-485 host interface. The setting of the AMC2-4R4 must correspond with the settings of the RS-232 / RS-485 converter.

### 4.9.1 RS-485 Two Wire Connection

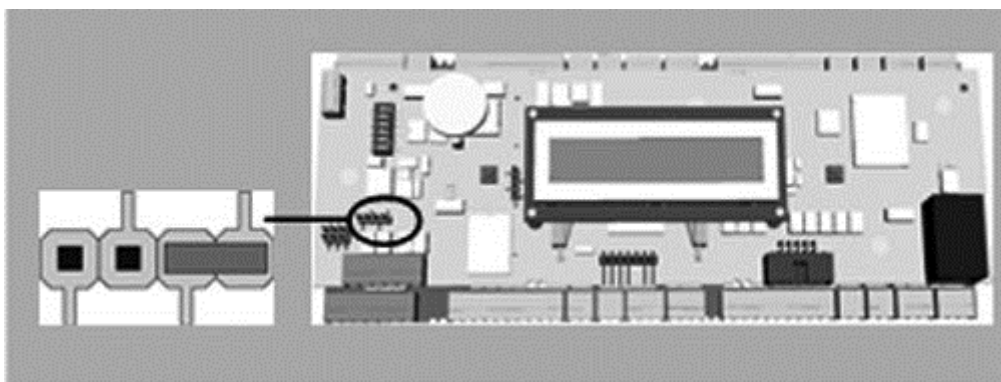

Figure 4.9: Setting of the jumpers for RS-485 two wire connections

### 4.9.2 RS-485 Four Wire Connection

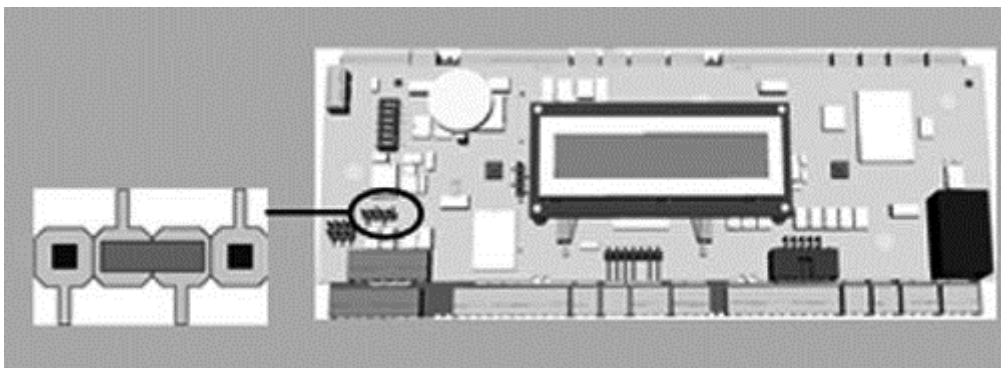

Figure 4.10: Settings for RS-485 four wire connection



**Notice!**

See the notices for setting the RS-232 / RS-485 converter.



**Notice!**

If a four-wire connection is used the interface must be set up as a crosslink.

## 4.10 RS-232 Host Interface

The AMC2 offers an RS-232 serial interface to connect a host computer or serial modem.



### Notice!

Risk of malfunction

Cable length between two RS-232 COM serial interfaces must not exceed 15 meters (45 ft).

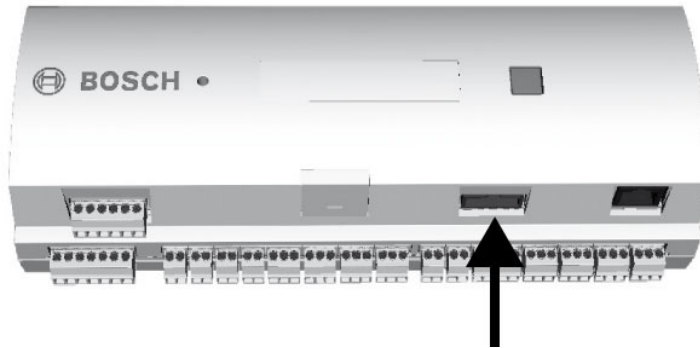

**Figure 4.11: Location of the RS-232 serial interface**

As the AMC2 controller is conceptionally a PC, it is not possible to connect them directly using normal cables. Use instead a null modem or “crossover” cable. A complete connection diagram of the RS-232 host interface is shown in chapter *Connecting Diagrams*, page 41



## 4.11 DIL switch selector

### 4.11.1 Host settings

DIL switches are used to configure the host settings. The first **four** DIL switches for address selection define the RS-485 address of the AMC2 in a RS-485 bus system. Switch **5** selects one of the two different protocols, SDEB and BPA (according to DIN6619). Switch **6** sets the connection to the host system to either RS-232 or RS-485.



#### Notice!

If using an Ethernet connection, set switch 1 to ON (= factory setting).

If using an RS-232 connection, set the address by configuring it in the Access Control System. This is a point-to-point connection that is usually configured as address 1, so set switch 1 to ON.

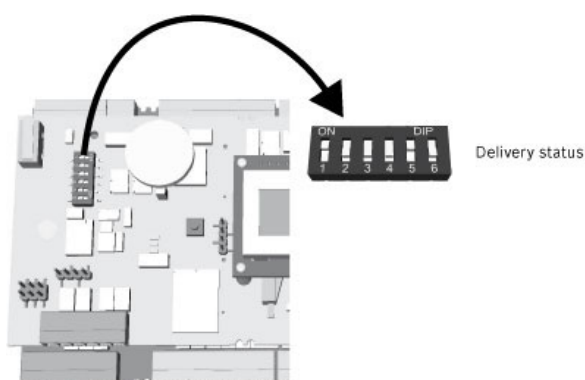

Figure 4.12: Location of the selector for host settings

Address	DIL Switches			
	1	2	3	4
None	OFF	OFF	OFF	OFF
1	<b>ON</b>	OFF	OFF	OFF
2	OFF	<b>ON</b>	OFF	OFF
3	<b>ON</b>	<b>ON</b>	OFF	OFF
4	OFF	OFF	<b>ON</b>	OFF
5	<b>ON</b>	OFF	<b>ON</b>	OFF
6	OFF	<b>ON</b>	<b>ON</b>	OFF
7	<b>ON</b>	<b>ON</b>	<b>ON</b>	OFF
8	OFF	OFF	OFF	<b>ON</b>

Tab. 4.1: Setting the address via the DIL switch

#### Instructions for DIL switch 5

Set **SDEB** (= DIL switch **5** to **ON**) in the following cases

- Ethernet host connection
- RS-485 host connection, provided only one AMC2 is connected on the bus

Set **BPA** (= DIL switch **5** to **OFF**) in the case of an

- RS-485 host connection with more than one and maximum eight AMC2s per bus



**Notice!**

Changing the type of the host connection requires a reset of the AMC2 - see *Resetting the Software*, page 36.

**4.11.2**

**Board Settings**

The address of the board is set using a switch on the board’s underside (see *Equipment Configuration*, page 8). The AMC2-4R4 is always assigned address **0**.

The extension boards are assigned the addresses **1 to 3**.



**Notice!**

When configuring the system, ensure that the order of boards in the Access Control System corresponds to the addresses you set using this switch.

This order of addressing determines the numbering of the boards’ signals.

Address	Signal-No.:	Signal-No.:
	AMC2-16ION	
0	0/ 01 - 16	
	AMC2-8IOE	AMC2-16IOE
1	1/ 01 - 08	1/ 01 - 16
2	2/ 01 - 08	2/ 01 - 16
3	3/ 01 - 08	3/ 01 - 16

**Tab. 4.2:** Signal numbering according to board address

**4.12**

**RS-485 for extension modules**

The RS-485 Extension Module Bus expands the AMC2-4R4 with additional I/O modules (AMC2-8IOE, AMC2-16IE, AMC2-16IOE).

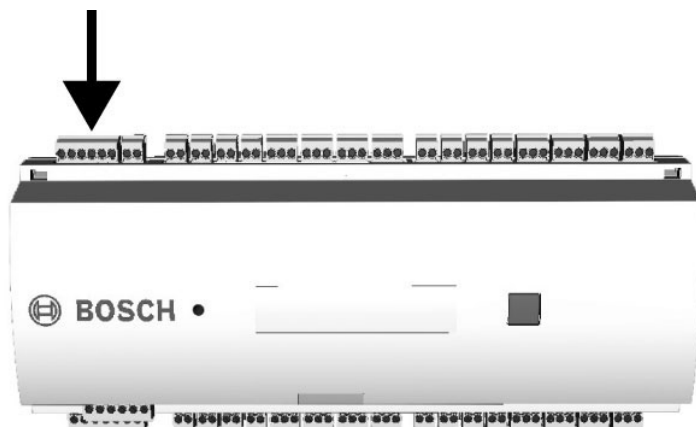
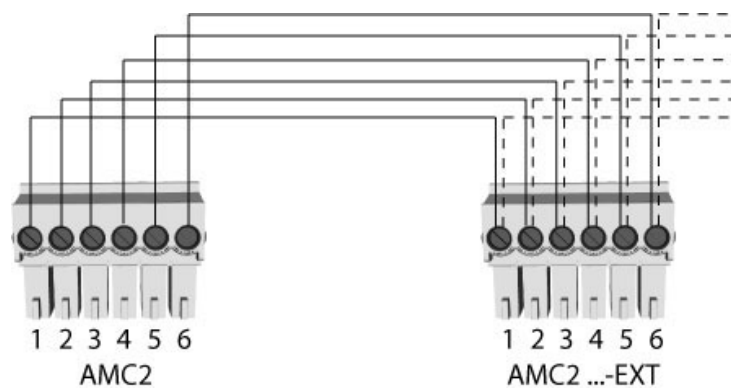

**Figure 4.13:** Location of the RS-485 extension module bus

Up to three expansion modules can be connected to provide additional in- and outputs, for example, for elevator control.

You can find further information about the extension boards in their installation manuals.

A complete connection diagram of the RS-485 extension module bus is shown in *Connecting Diagrams, page 41*.



**Figure 4.14: Connection of an extension module to an AMC2**

## 4.13 Connecting Relay Outputs

To operate locks or alarm systems, the AMC2-4R4 has eight relay outputs. The outputs will be connected to the 3-pin pluggable screw connectors S5, S6, S10, S11, S17, S18, S22, and S23 - refer to chapter *Connecting Diagrams*, page 41.

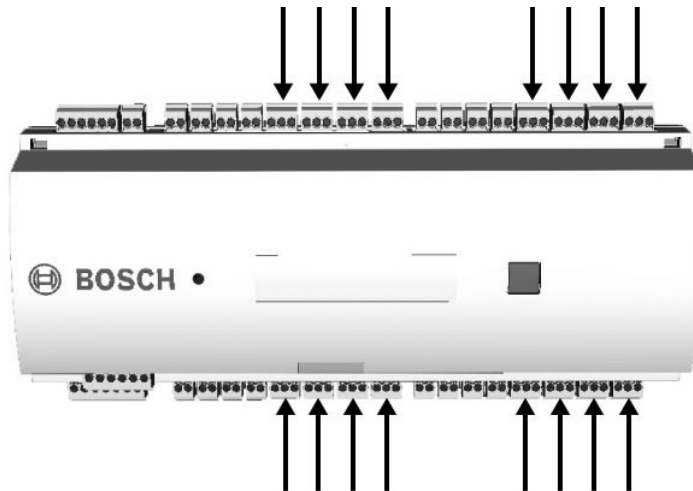

Figure 4.15: Location of the relay output connectors

Each relay output can operate in 'wet' mode, using the AMC2-4R4's internal 12/24 Vdc power supply for external devices or 'dry' mode with potential free contacts for externally powered systems.

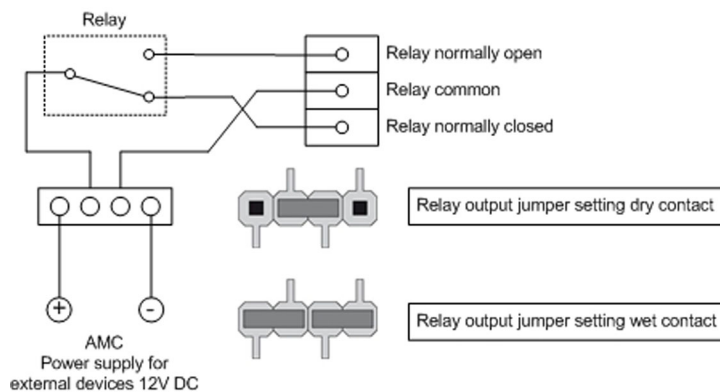

Figure 4.16: Wet mode and dry mode of the AMC2 relay outputs



### Notice!

#### Risk of damage to equipment

To prevent damage to the relays note the following specifications.

- the maximum switching current is 1.25 A
- the maximum switching voltage is 30 Vdc
- only ohm resistive load can be connected to the relay
- inductive loads have to be short circuited using recovery diodes, see image below. These diodes (1N4004) are supplied with every AMC2-4R4 package.
- If you need higher voltage for special applications you have to connect external relays to the outputs. Depending on the power supply mode, it is recommended to use the following Wiegand relay types:

- Flare move 12DC1W10A
- Flare move 24DC1W16A

If using locally manufactured products, please ensure that the specifications of the product are identical with the those listed above.

A complete connection diagram of the relay output connectors is shown in *Connecting Diagrams, page 41*.

wet mode:

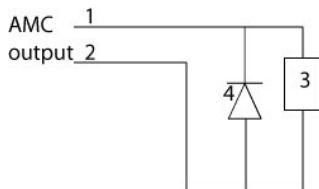

dry mode:

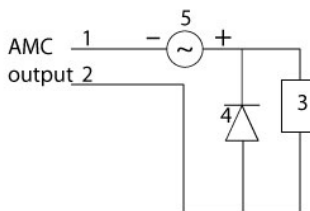

Figure 4.17: Recovery diode schematic

1	normally open/normally closed	1	normally open/normally closed
2	common	2	common
3	load	3	load
4	diode	4	diode
		5	voltage source



**Notice!**

**Risk of damage to equipment**

Do not connect externally powered devices in wet mode. This can damage the AMC2-4R4.

Each relay output has a separate jumper setting on the underside of the circuit board to select dry (E1) or wet (E2) mode.

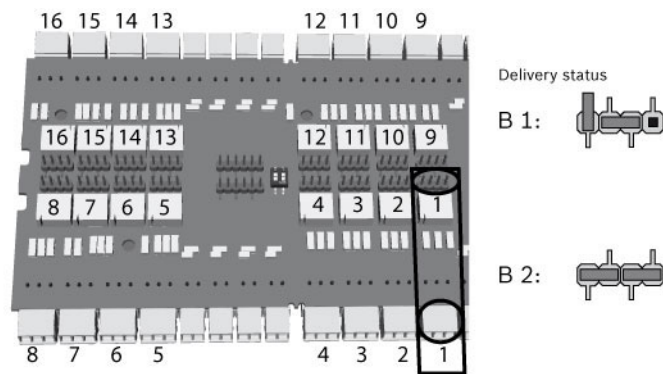

Figure 4.18: Location of relay output jumpers

## 4.14 Connecting Analog Input Devices



**Notice!**

Risk of damage to equipment

Do not connect external power supply to the AMC2 inputs.

When connecting a relay output to an AMC2 input use dry mode with potential-free contact - refer to *Connecting Relay Outputs*, page 28.

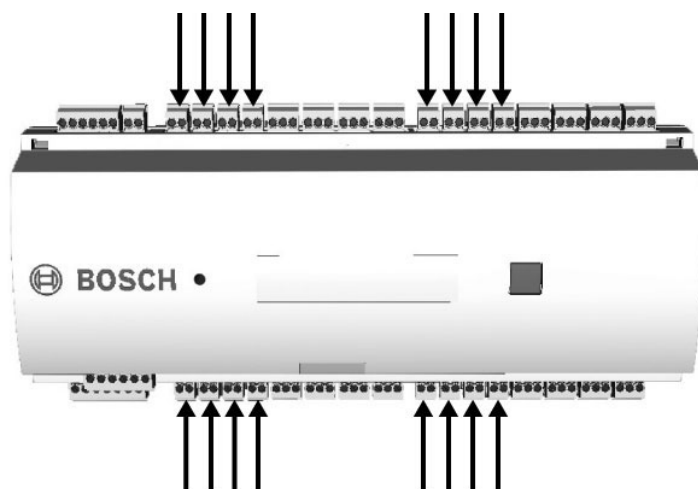

**Figure 4.19: Location of the analog input connectors**

To detect the four states, the voltage drop in the connecting cable may not exceed special values. The following table shows the maximum values of permissible cable resistance depending on the used resistor combination.

$R_P$	1k	1k2	1k5	1k8	2k2	2k7	3k3	3k9	4k7	5k6	6k8	8k2
$R_S$												
1k	220	220	220	210	200							
1k2	260	270	270	270	260	240						
1k5	310	330	340	350	350	340	310	280				
1k8	340	380	390	410	410	410	400	370	330	290	200	
2k2		430	460	490	510	520	510	500	460	420	340	240
2k7		490	540	570	620	630	640	640	620	580	510	420
3k3			610	650	700	740	770	780	770	750	700	620
3k9				720	790	850	890	910	910	910	880	810
4k7					880	960	960	970	1100	1100	1050	1050
5k6						1050	1100	1200	1200	1300	1300	1250
6k8							1300	1400	1500	1500	1500	1500

$R_p$	1k	1k2	1k5	1k8	2k2	2k7	3k3	3k9	4k7	5k6	6k8	8k2
$R_s$												
8k2								1500	1650	1700	1800	1900

**Table 4.3: Maximum values of cable resistance per used resistor combination in Ohm**



## 4.15 Tamper Protection

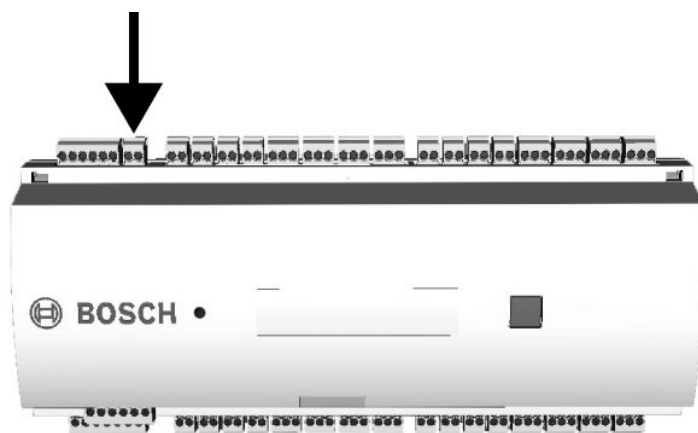

Figure 4.20: Location of the tamper protection contact

## 5 Operating

### 5.1 Status Display of the AMC2

The liquid crystal display delivers status information about the AMC2-4R4. Push the 'Dialog' button to switch between different modes.

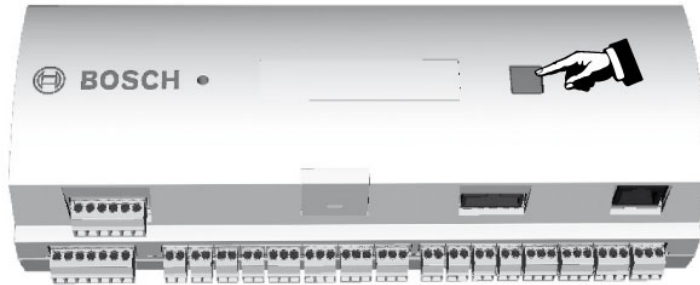

Figure 5.1: Location of the 'Dialog' button

Push	Display (Example)	Description
0	V01.00 02.03.07 or LBUS or BG900	Software versions and date of the firmware - every 5 sec. alternating with the display of the reader interface.
1a	S/N1: 0910019212	BOSCH serial number
1b	S/N2: 00000001	
2	02.06 15:35:15 (S)	Current date and time (S) = Summer; (W) = Winter
3	Dig. IO: ::::::::::::::	Display of the digital contacts: the input signals set will be shown with an extension above - output signals with an extension below.
3a	Dig. I1: ::::::::::::::	If there are I/O-Boards connected the signals will be shown on separate pages.
3b	Dig. I2: ::::::::::::::	
3c	Dig. I3: ::::::::::::::	
4	MAC 0010174C8A0C	Network device address (MAC)
5	N AMC-1234-5678	Network name of the AMC2
6	I 192.168.10.18	IP-address of the AMC2
7	G 192.168.10.255	IP-address of the gateway (Version V 00.44 or higher)
8	M 255.255.255.0	Subnetmask (Version V 00.44 or higher)
9	H 192.168.10.10	IP-address of the host computer
10	DHCP 1	DHCP-status: 1 = on 0 = off
11	D 192.168.10.1	IP-address of the DNS server
12	Host: + "C"	Host activity: + = online - = offline "C" = Counter of the received data packages from the host interface. RS 485 Bus connection: A = Address 1 ... H = Address 8

## 5.2 Configuring the Ethernet Interface

The access control system **Access Personal Edition** has an entry of this tool in its program folder:

Start > Programs > Access Personal Edition > AmcIpConfig

This tool can be copied and used on every computer on the network.

## 5.3 Troubleshooting

If there is no indication on the display, check voltage provided from the power supply, power up the controller.

If the controller is not online, or operation is not as expected per configuration:

1. Check connections/ configuration as per described in Chapter 4 and Section 5.2.
2. Cycle the power of the controller.
3. In rare cases reset the controller software as described in Section 5.3.1.
4. For factory default reset refer to Section 5.3.2.

If problem persists, please request after sales support.

### 5.3.1 Resetting the Software

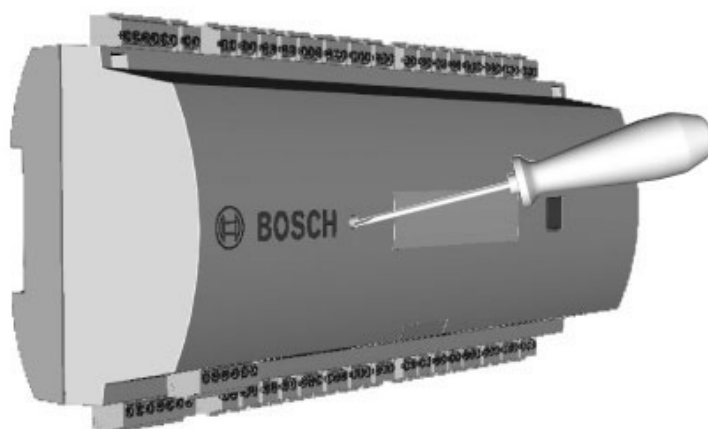

Figure 5.2: Resetting the AMC2 16I-160-NET

### 5.3.2 Resetting the Device to Factory Default

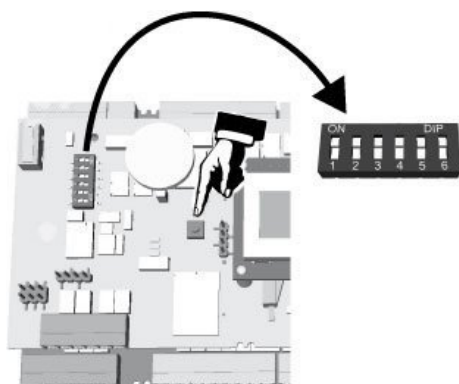

Figure 5.3: Resetting the AMC2 to delivery state

## 6 Technical Data

### Hardware

- Integrated Microcontroller (32 bit, 30 MHz)
- SRAM (256 kB)
- Serial EEPROM
- RTC (real time clock)
- Pluggable Compact Flash card
- Battery for SRAM and RTC
- DIL switch for host settings (address and protocol mode)
- Host interfaces
  - Ethernet 10/100 Mbit/s
  - RS-485 2-wire or 4-wire  
Transfer rate: 38,4 kBit/s,  
even parity, 7 bit, 1 stop bit,
  - RS-232  
Transfer rate: 38,4 kBit/s  
no parity, 8 bit, 1 stop bit
- Eight relay outputs
  - maximum ratings (wet and dry):  
switching voltage: 30 Vdc  
switching current: 1,25 A
  - operating ratings (wet and dry):  
1,25 A @ 30 Vdc  
2 A @ 12 Vdc  
1,5 A @ 24 Vdc
- Eight analog inputs with sabotage monitoring; only connect dry contacts
- RS-485 extension interface:
  - Transfer rate: 9,6 kBit/s,
  - no parity, 8 bit, 2 stop bit
  - Output power rated maximum 2.5 A @ 10 - 14 Vdc (voltage output is dependent on board voltage input)
- Tamper contact for external enclosures

### Power supply

10 to 30 Vdc

### Display

64,8 mm x 13,9 mm (2.551 x 0.547 in.)

1 line, 16 characters

### Power consumption

AMC: 5 VA

Peripheral devices: using the PSU-60

- up to 55 VA
- constant load: 25 VA

### Connectors

Pluggable screw connectors

**Protection class**

IP30

**Environment temperature**

13° C to 35° C (55° F to 95° F)

**Humidity**

Up to 95%, without condensation

**Housing material**

ABS with OC (UL 94 V-0)

**Dimensions**

(W/H/D) 232 x 90 x 63mm (8.9 x 3.5 x 2.5 in)

**Weight**

approx. 0.53kg (1.2lb)





# 7 Appendices

## 7.1 Connecting Diagrams

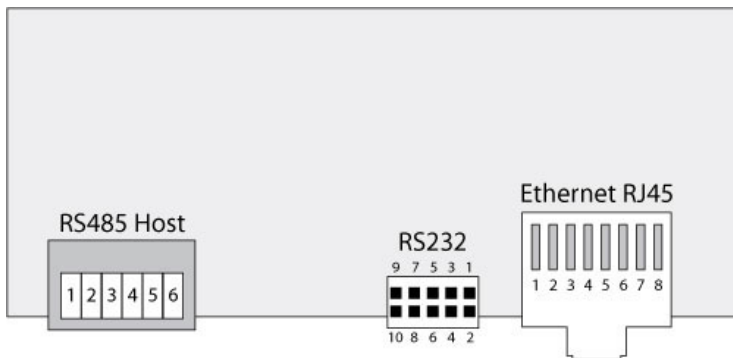

**Figure 7.1:** Connectors on upper PCB

	1	Shield
	2	Data RxTx+ (2-wire) Data Rx+ (4-wire)
	3	Data RxTx- (2-wire) Data Rx- (4-wire)
	4	Ground (PAG)
	5	Data Tx+ (4-wire)
	6	Data Tx- (4-wire)

**Tab. 7.4:** RS-485 host on upper PCB

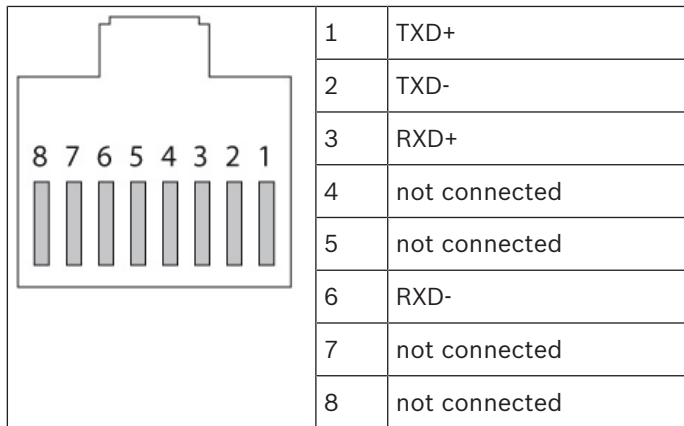

Tab. 7.5: Ethernet Network socket (RJ45)

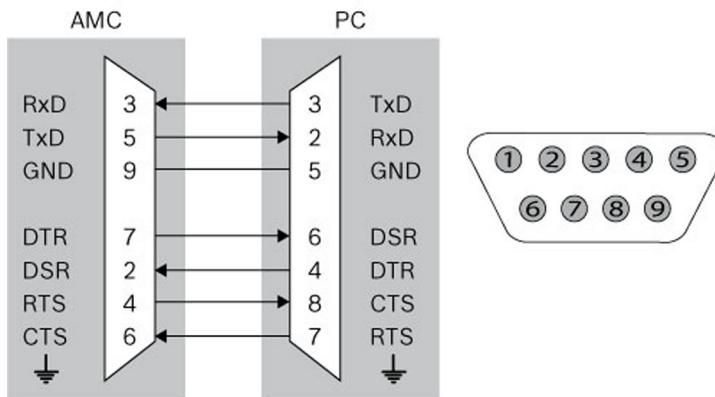

Figure 7.2: Interconnect diagram of the RS-232 serial interface

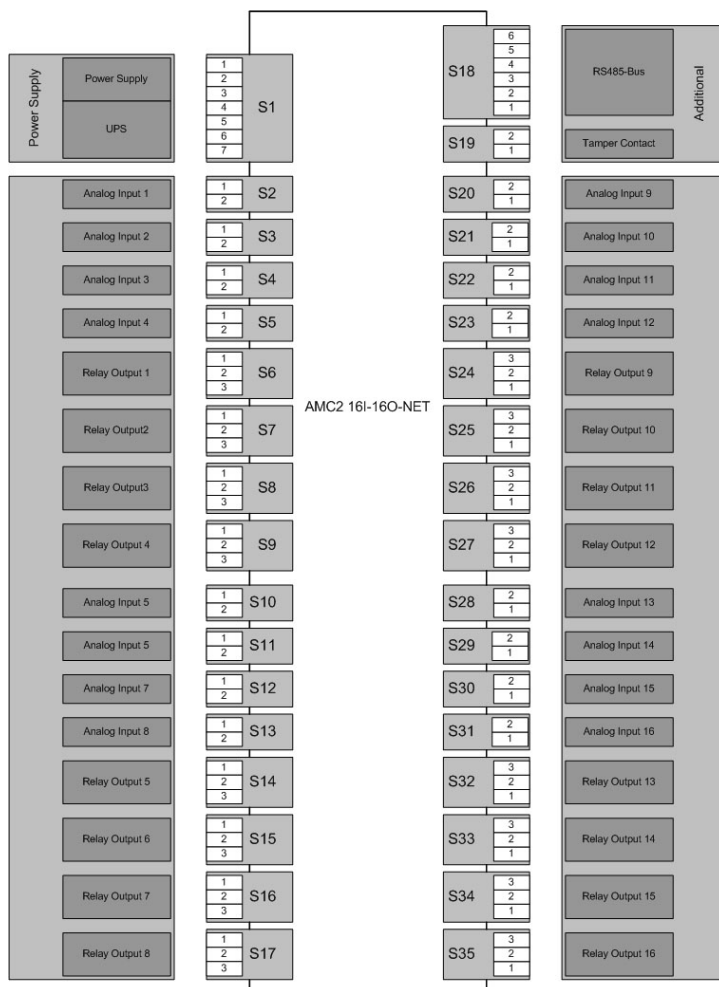

Figure 7.3: Connector blocks of the AMC2-16ION

	1	Power supply, DC positive (10V - 30V)
	2	Shield
	3	Power supply (0V)
	4	UPS (power good signal) - AC
	5	UPS (power good signal) - Battery
	6	UPS (power good signal) - DC
	7	UPS (power good signal) - Common

Tab. 7.6: Power supply

	1	Analog Input, in
	2	Analog Input, out

Tab. 7.7: Analog input

	1	Relay Output, normally open
	2	Relay Output, common

	3	Relay Output, normally closed
--	---	-------------------------------

**Tab. 7.8:** Relay output

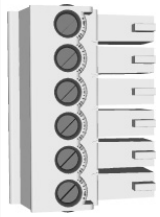
	1	Power supply for external devices (10V - 30V)
	2	Power supply for external devices (0V)
	3	Shield
	4	Data RxTx+
	5	Data RxTx-
	6	Ground (PAG)

**Tab. 7.9:** Host / Extension interface

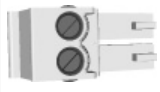
	1	Tamper Contact, in
	2	Tamper Contact, out

**Tab. 7.10:** External tamper contact

## Index

### D

DIL 8, 11, 25  
display 34

### E

Ethernet host interface 11  
Ethernet interface 21  
extension interface 19, 38  
extension interfade 26

### G

grounding 18

### H

host interfaces 11, 22, 38

### I

I/O board 26  
inputs 11, 38  
interfaces  
    extension 19, 38  
    host 11, 21, 22, 24, 38  
interfades  
    extension 26

### L

LCD 34

### M

mounting 13

### O

opening 15  
outputs 11, 28, 38

### P

power supply 16, 20

### R

RS-232 host interface 11, 24  
RS-485 host interface 9, 11, 22

### S

shielding 18

### T

transfer rates 11, 38

### U

unmounting 14







**Bosch Security Systems B.V.**

Torenallee 49

5617 BA Eindhoven

Netherlands

**[www.boschsecurity.com](http://www.boschsecurity.com)**

© Bosch Security Systems B.V., 2020