

22260245	DATA SHEET	
Valid from: 19.12.2023	AB-C3-M8MS-(L*)PUR-M12FA	

Product description

- Sensor/actuator cable, 3-pol, PUR halogen-free, black
- Straight M8-plug on angled M12-jack



General characteristics

Number of pins	3
Ambient temperature	-25 °C to +90 °C (-13°F to 194°F) (plug / jack) -40 °C to +80 °C (-40°F to 176°F) (cable, fixed installation) -25 °C to +80 °C (-13°F to 176°F) (cable, movable installation)
Degree of protection	IP65 / IP67 / IP68
Coding	A-standard
Tightening torque	0,4 Nm (M12-connector) 0,2 Nm (M8-connector)
Plugging cycles	≥ 100

Variation

Article number	Description	Length [m]	Configuration
22260245	AB-C3-M8MS-0,3PUR-M12FA	0,3	straight - angled
22260246	AB-C3-M8MS-0,6PUR-M12FA	0,6	straight - angled
22260247	AB-C3-M8MS-1,0PUR-M12FA	1	straight - angled
22260248	AB-C3-M8MS-2,0PUR-M12FA	2	straight - angled
22262117	AB-C3-M8MS-8,0-PUR-M12FA	8	straight - angled

Additional note

Data sheet also valid for variant lengths. Other lengths on request.

Electrical properties

Rated voltage	48 V AC / 60 V DC
Rated current	4 A
Overvoltage category	II
Pollution degree	3

Mechanical properties

Plug, jack

Inflammability class in accordance with UL 94	HB
Contact, material	CuSn
Contact carrier, material	TPU GF
Contact surface, material	Ni/Au
Knurl, material	Zinc diecasting, nickel-plated
Handle, material	TPU, flame retardant, self-extinguishing
Sealing, material	NBR

Creator: THLE3/PDP Released: IVSE1/PDP	Document: DB22260245EN Version: 06	Page 1 of 3
---	---------------------------------------	-------------

22260245	DATA SHEET	
Valid from: 19.12.2023	AB-C3-M8MS-(L*)PUR-M12FA	

Line

Cable construction	3 x AWG24/32
Signal line, construction	32 x 0,1 mm
Conductor cross-section	0,25 mm ²
Conductor diameter including isolation	1,17 mm ± 0,02 mm
Cable outer diameter	4,4 mm ± 0,15mm
Insulation color	brown, blue, black
Sheath color	grey-black, RAL 7021
Number of bending cycles	10.000.000
Bending radius	44 mm
Traveling distance	10 m
Traveling speed	3 m/s
Acceleration	10 m/s ²
Cable weight	18 kg/km
Outer coating, material	PUR
Wire insulation, material	PP
Insulation resistance	≥ 100 GΩ*km (at 20 °C)
Conductor resistance	≤ 78 Ω/km (at 20 °C)
Flame resistance	acc. to UL 758 / 1581 FT2 DIN EN 60332-2-2 (20 s)
Halogen-free	acc. to DIN VDE 0472 Part 815
Oil resistance	acc. to DIN EN 60811-2-1
Other resistances	resistant to hydrolysis and microbes good resistant to acids, lyes and solvents limited UV resistance acc. to DIN EN ISO 4892-2-A

Standards

Product standard, M12 connector	IEC 61076-2-101
Product standard, M8 connector	IEC 61076-2-104
UL-Listed, E-File	E249137

Creator: THLE3/PDP Released: IVSE1/PDP	Document: DB22260245EN Version: 06	Page 2 of 3
---	---------------------------------------	-------------

22260245	DATA SHEET	
Valid from: 19.12.2023	AB-C3-M8MS-(L*)PUR-M12FA	

Technical drawing

Dimensional drawing

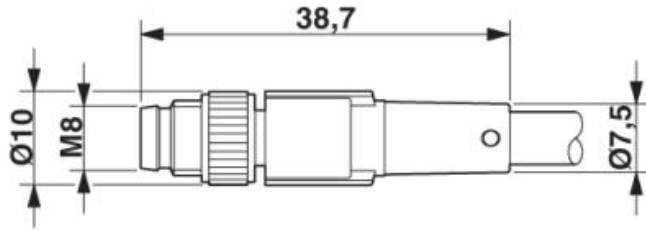

Plug M8 x 1, straight

Dimensional drawing

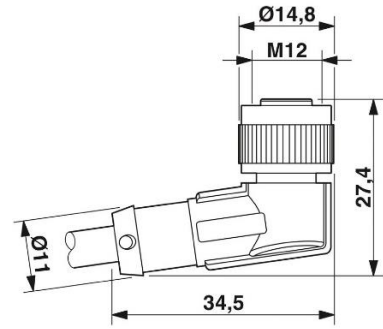

Jack M12 x 1, angled

Drawing

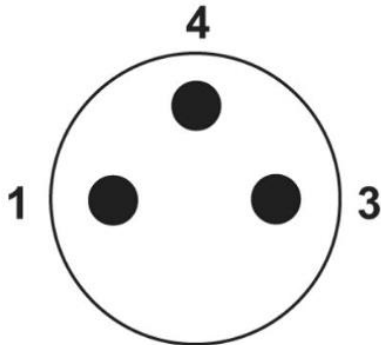

Pin assignment M8-plug, 3-pol, A-coding

Drawing

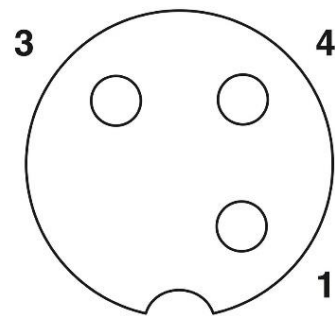

Pin assignment M12-jack, 3-pol, A-coding

Circuit diagram

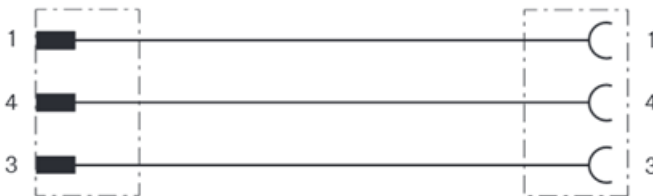

Pin assignment between M8-plug and M12-jack

Wire cross section

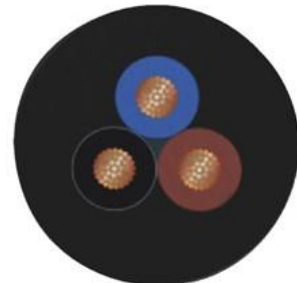

Application range

For increased mechanical load and rough operating conditions

Note

Photographs are not true to scale and do not represent detailed images of the respective products

Creator: THLE3/PDP Released: IVSE1/PDP	Document: DB22260245EN Version: 06	Page 3 of 3
---	---------------------------------------	-------------