

22260408	<b>DATA SHEET</b>	
Valid from: 21.12.2023	<b>AB-C5-(L*)PUR-M12FA-3L</b>	

## Product description

- Sensor/actuator cable, 5-pol, PUR halogen-free, black
- Angled M12-jack on free conductor end
- 3 LEDs



## General characteristics

Number of pins	5
Ambient temperature	-25 °C bis +90 °C (-13°F bis 194°F) (plug / jack) -40 °C bis +80 °C (-40°F bis 176°F) (cable, fixed installation) -25 °C bis +80 °C (-13°F bis 176°F) (cable, movable installation)
Degree of protection	IP65 / IP67 / IP68
Coding	A-standard
Tightening torque	0,4 Nm (M12-connector)
Plugging cycles	≥ 100

## Variation

Article number	Description	Length [m]	Configuration
22260408	AB-C5-2,0PUR-M12FA-3L	2	angled
22260409	AB-C5-5,0PUR-M12FA-3L	5	angled
22260416	AB-C5-10,0PUR-M12FA-3L	10	angled
22260760	AB-C5-25,0PUR-M12FA-3L	25	angled
22261084	AB-C5-50,0PUR-M12FA-3L	50	angled

## Additional note

Data sheet also valid for variant lengths. Other lengths on request.

## Electrical properties

Rated voltage	24 V DC
Rated current	4 A
Overvoltage category	II
Pollution degree	3

## Mechanical properties

### Jack

Inflammability class in accordance with UL 94	HB
Contact, material	CuSn
Contact carrier, material	TPU GF
Contact surface, material	Ni/Au
Knurl, material	Zinc diecasting, nickel-plated
Handle, material	TPU, flame retardant, self-extinguishing
Sealing, material	NBR

Creator: THLE3/PDP Released: IVSE1/PDP	Document: DB22260408EN Version: 06	Page 1 of 3
---	---------------------------------------	-------------

22260408	<b>DATA SHEET</b>	
Valid from: 21.12.2023	<b>AB-C5-(L*)PUR-M12FA-3L</b>	

**Line**

Cable construction	5 x AWG22/42
Signal line, construction	42 x 0,1 mm
Conductor cross-section	0,34 mm <sup>2</sup>
Conductor diameter including isolation	1,27 mm ± 0,02 mm
Cable outer diameter D	5,0 mm ± 0,15mm
Insulation color	brown, white, blue, black, green/yellow
Sheath color	grey-black, RAL 7021
Number of bending cycles	10.000.000
Bending radius	50 mm
Traveling distance	10 m
Traveling speed	3 m/s
Acceleration	10 m/s <sup>2</sup>
Cable weight	33 kg/km
Outer coating, material	PUR
Wire insulation, material	PP
Insulation resistance	≥ 10 GΩ*km (bei 20 °C)
Conductor resistance	≤ 78 Ω/km (bei 20 °C)
Flame resistance	acc. to UL 758/1581 FT2 DIN EN 60332-2-2 (20 s)
Halogen-free	acc. to DIN VDE 0472 Part 815
Oil resistance	acc. to DIN EN 60811-2-1
Other resistances	resistant to hydrolysis and microbes good resistant to acids, lyes and solvents limited UV resistance acc. to DIN EN ISO 4892-2-A resistant to sea water

**Standards/Approvals**

Product standard, M12 connector	IEC 61076-2-101
UL-Listed, E-File	E249137

Creator: THLE3/PDP Released: IVSE1/PDP	Document: DB22260408EN Version: 06	Page 2 of 3
---	---------------------------------------	-------------

22260408	<b>DATA SHEET</b>	
Valid from: 21.12.2023	AB-C5-(L*)PUR-M12FA-3L	

## Technical drawing

Dimensional drawing

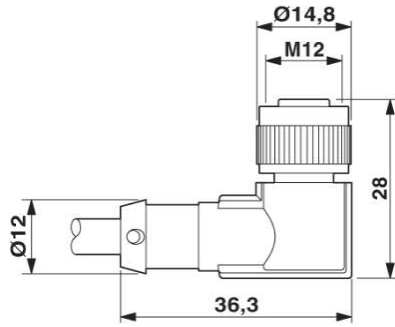

Jack M12 x 1, angled, with LED

Circuit diagram

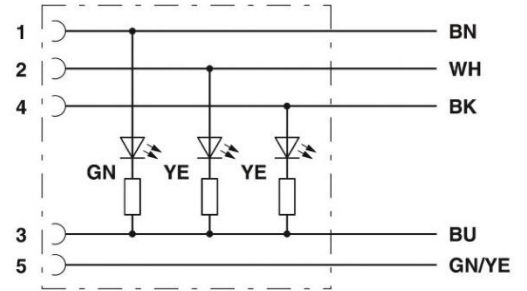

Pin assignment M12-jack, with LED

Drawing

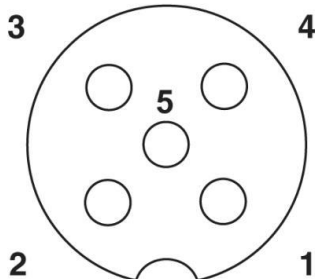

Pin assignment M12-jack, 5-pol, A-coding

Wire cross section

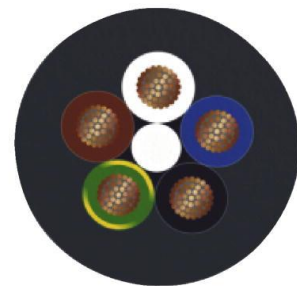

## Application range

For increased mechanical load and rough operating conditions

## Note

Photographs are not true to scale and do not represent detailed images of the respective products.

Creator: THLE3/PDP Released: IVSE1/PDP	Document: DB22260408EN Version: 06	Page 3 of 3
---	---------------------------------------	-------------