

Connector PowerTOP

Part number: 3881



MENNEKES
Elektrotechnik GmbH & Co. KG

Aloys-Mennekes-Straße 1
57399 Kirchhundem
GERMANY

www.MENNEKES.org

Product Description

- screw connection technology
- protection against kinking
- strain relief
- cable gland and external grip

Technical Details

Connector PowerTOP	3881
Product serie	PowerTOP
Ampere	16A
Number of poles	5p
Clock position	6h
Nominal voltage AC	400V
Nominal frequency	50 - 60 Hz
Protection type IP	IP67
Contact carrier	standard
X-CONTACT	no
Connection	screw terminals
Contact screw drive	PZ2, slot
Recommended wire end treatment for supply cable connection terminal	ferrule square gasproof crimped
Pilot contact	without pilot contact
Conductor cross-section min.	1 mm ²
Conductor cross-section max.	2.5 mm ²
Cable kink protection	integrated in cable gland
Protective grommet	without protective grommet
Weight (net)	310 g
Packaging unit	10 pcs
EAN / identification number	4015394099826

Permissible ambient conditions

	Min.	Max.
Permanent ambient temperature	-25 °C	40 °C

Material properties

Housing	PA6 red [similar RAL 3013]
Hinged lid	PA6 red [similar RAL 3013] TPE black [similar RAL 9005] PBT/PC squirrel grey [similar RAL 7000]

Material resistance

The material resistance overview can be found on the website in the section “Knowledge” - “Product knowledge” - “Materials”.

Material and environmental properties

RoHS 2011/65/EU incl. 2015/863/EU	✓
POP regulation (EU) 2019/1021	✓

Regulations and Standards

Norm	DIN EN IEC 60309-2
Declaration of Conformity	CE
Test label	VDE, EAC, CQC

Dimensional Drawing

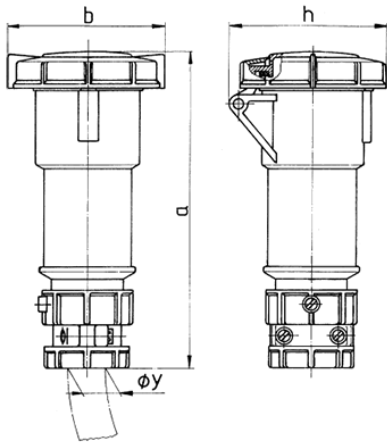

Drawing 3 MB 48/3	Amp. Poles	16			32		
		3	4	5	3	4	5
Dim. in mm	a	171	182	194	217	217	229
	b	78	85	96	103	103	110
	h	79	88	95	99	99	105
	y	19	19	22	24.5	24.5	28.5
Terminal for cond. cross		1	1	1	2.5	2.5	2.5
section (mm ²) min.-max.		—2.5	—2.5	—2.5	—6	—6	—6