

CATALOG 2021

Pilot devices, 22 mm

The complete offering



ABB pilot devices are engineered for total reliability. Their innovative design simplify the entire process, from selection to installation. Enclosures, signal towers and signal beacons complete the portfolio.



Pilot devices

The complete offering

OVERVIEW
P.2

**MODULAR
PLASTIC RANGE**
P.13

**MODULAR
METAL RANGE**
P.55

COMPACT RANGE
P.89

**ENCLOSURES
AND ASSEMBLED
STATIONS**
P.121

**LEGEND PLATES
AND TEXT CAPS**
P.133

**SIGNAL TOWERS
AND SIGNAL
BEACONS**
P.141

**GENERAL
TECHNICAL DATA**
P.150

INDEX
P.152

**MARKETING
MATERIALS**
P. 168

Pilot devices

Reliable in all applications

Whether it is installed in an EV charger or in the testing equipment of an elevator ABB pilot devices will work as a reliable interface for operators. They are designed and tested to withstand extreme environments.



—
01



—
02

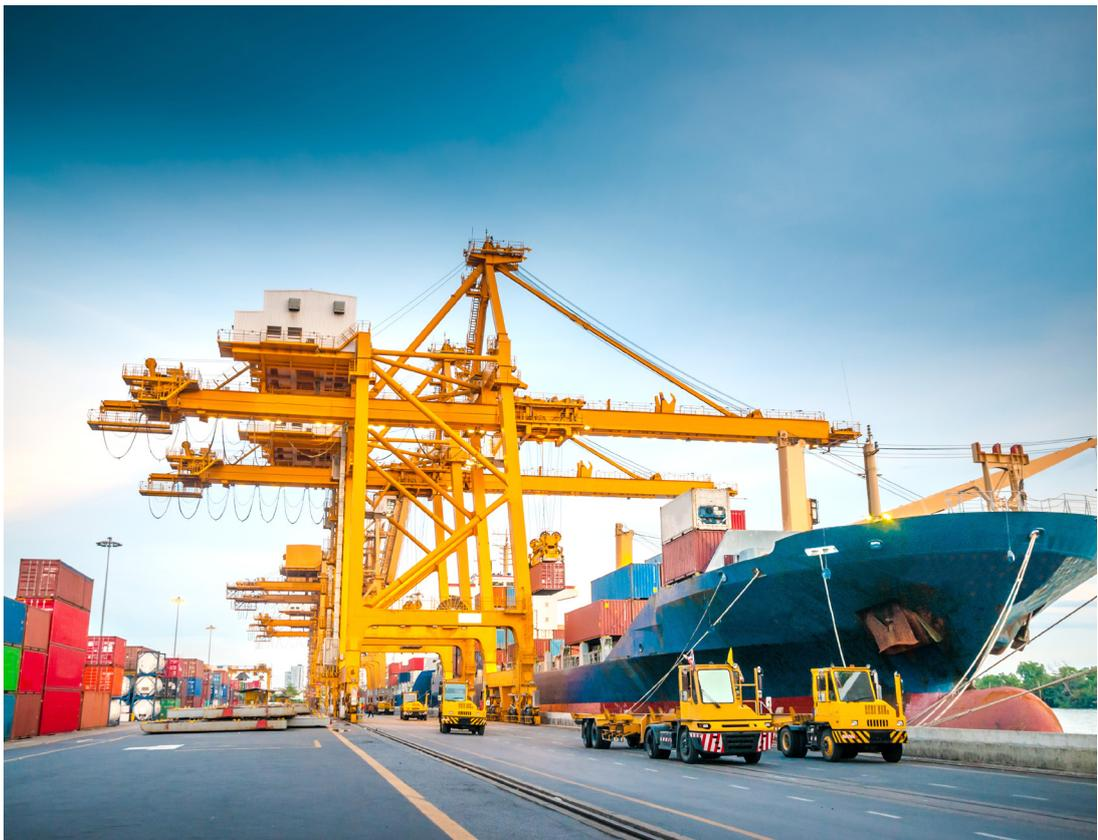

—
03

- 01 Elevator
- 02 EV charging
- 03 Marine

A small upgrade that can make a big difference.

Trust is everything. And in industrial environments, it is essential to have human-machine interfaces you can count on. Whenever you start or stop a process, the response must be assured. That’s why ABB pilot devices are designed and engineered to deliver total reliability.

Continuous production, maximum uptime and higher profits require exceptional process reliability.



—
04

—
04 Food and beverage
—
05 Marine and ports

When it comes to the safety of your people, dependability is essential.



—
05

The details matter. Work starts and stops with pilot devices and so does your productivity and safety. Rely on ABB pilot devices to perform when it matters the most.

Pilot devices

Reliable products, easy to select and install



ABB pilot devices are engineered for total reliability. Our products are tested to extremes and proven in the toughest environments. Their innovative design simplify the entire process, from selection to installation. Enclosures, signal towers and signal beacons complete the portfolio.



Continuous operation

Engineered for tough environments

ABB pilot devices are designed with protection degree of up to IP69K and 4X, guaranteeing reliability in extreme environments – making ABB pilot devices ideal for use in demanding industries such as construction and food and beverage. An innovative design that automatically cleans contacts ensures high reliability for all products.



Global availability

Simple selection and stock management

ABB's core offering includes the pilot devices most in demand, so product selection is easier, stock management is simpler and product availability is higher.

Support for exporters is world-class, thanks to ABB's standardized global range, certified to comply with all major international standards.



Easy to install

Save time and space

The unique design of ABB's modular ranges enable tool-free installation that is quick and simple. It provides high flexibility for last-minute changes. With its all-in-one construction, the compact range reduces installation space and saves time.

Pilot devices

Reliability that lasts

Continuous operation

Longer lifetime

- ABB pilot Devices are engineered and tested to sustain frequent use over time in any environment

High mechanical durability

- Tested to achieve mechanical life time of up to 10 million operations

Ensuring electric connectivity

- Self-cleaning contacts ensure reliable operation without the need for maintenance, increasing uptime

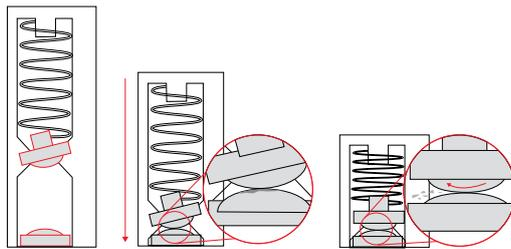

The built-in wiping mechanism cleans the contacts when operated to remove dust and oxidation on the contacts and improve conductivity.

Dust and water proof

All ABB pilot devices are impenetrable to dust and are extremely resistant to water exposure.

IP66

IP66-classed pilot devices can withstand high-pressure water jets and are suitable for tough outdoor use.

IP67

IP67-classed pilot devices can withstand immersion in one metre of water for 30 minutes. They are suitable for use in the harshest environments with water and dust.

IP69K

IP69K pilot devices can withstand both rough treatment and intensive, high-temperature cleaning. They are ideal for environments with high sanitary requirements, such as the food and beverage industry.

Find full test description in general technical data section.

—
01 Mechanical durability test

—
02 Total protection against any kind of dust

—
03 Powerful water jets projected against the front from a distance of 3 meters

Testing that goes beyond the standards



Watch the video

—
Trust ABB to produce products that work in any environment.

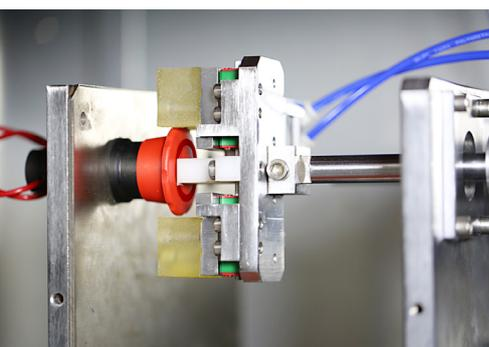

—
01



—
02



—
03

Pilot devices

Global quality, local support



Global availability

Available worldwide from ABB

Achieve truly global solutions

- Same products and quality all around the world
- Local support available everywhere with ABB's global distribution network
- All certificates and spare parts available globally.

Always the right solution with the wide range of LEDs

Save time and money on your projects with fewer order codes for your illuminated products.

With supply voltage of 6.3 V DC to 415 V AC for both modular and compact range, ABB covers all the needs with no additional transformers.

Easy to install

Reduce installation time by choosing between the flexible modular ranges and the all-in-one compact range of pilot devices.

Mixing and matching the two ranges enables faster and more flexible purchasing and design. Fastening of the nut is tool-free and most accessories can be used for both ranges.

Modular plastic range

Flexible configuration

A versatile selection of operators with high levels of flexibility and a broad choice of electrical ratings. Find the perfect solution for almost every application.

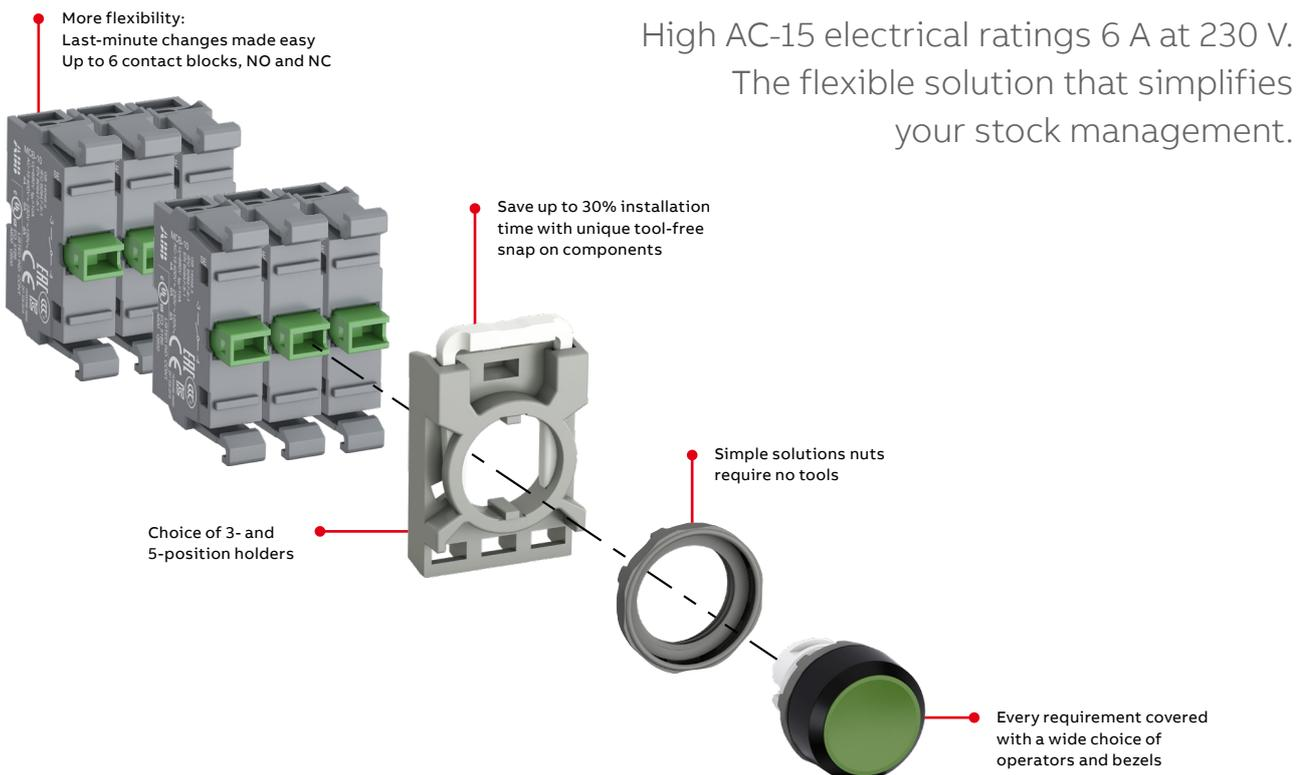

Modular metal range

Designed for demanding applications

ABB’s modular metal range combines ultimate reliability with the total flexibility of a modular range. For mining, construction and heavy industry applications, find the right solution here.



IP66 aluminium metal enclosures are available to accompany this range



Compact range

All-in-one solution

The most efficient solution available, reducing installation time and cost. The compact range have the highest level of dust and water resistance on the market.



Pushbuttons



Heavy duty pushbuttons



Mushroom pushbuttons



Emergency stop pushbuttons



Machine stop pushbuttons



Pilot lights



Selector switches



Buzzers

Fewer order codes make selection easy and save time.
All-in-one design makes installation fast.



Improve reliability:
Higher protection levels
with IP66, IP67 and
IP69K classification and
4X (NEMA)

Compact:
Just 42 mm
built in depth

Pilot devices, 22 mm

Modular plastic range

Ordering details

14	Mounting instructions
15	Non-illuminated pushbuttons
17	Illuminated flush pushbuttons
19	Non-illuminated double pushbuttons
20	Illuminated double pushbuttons
22	Mushroom pushbuttons
23	Emergency stop pushbuttons
24	Machine stop pushbuttons
25	Heavy duty pushbuttons
26	Non-illuminated selector switches
32	Illuminated selector switches - 2, 3 and 4 position
36	Key-operated selector switches - 2 and 3 position
38	Potentiometers
39	Reset pushbuttons
41	Joysticks
42	Toggle switches

Accessories for modular range

43	Contact block configuration
44	Holders and contact blocks for front mounting
45	LED blocks for front mounting
47	Other accessories

Technical data

Drilling plan

Modular plastic range

02

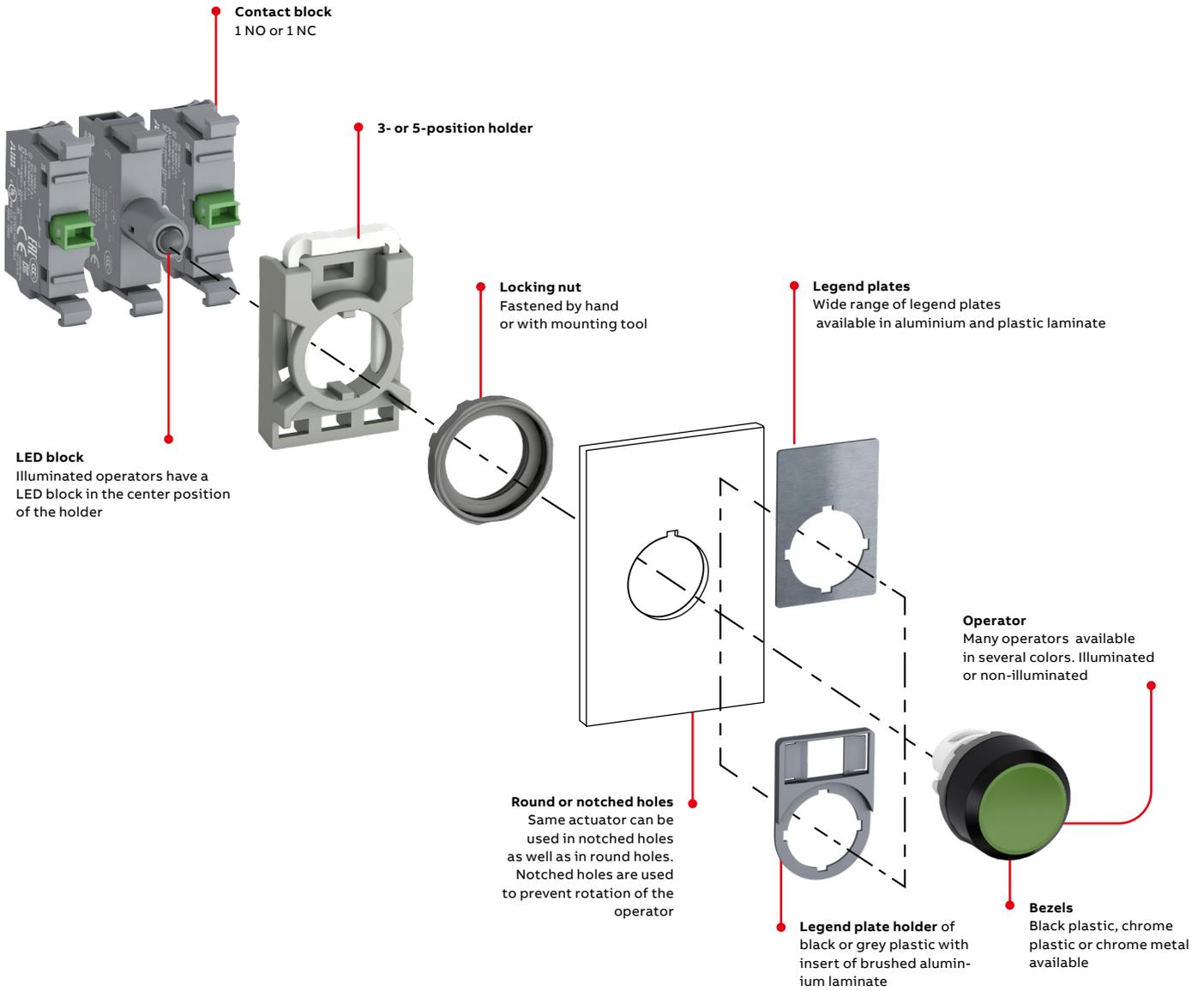

Easy to install

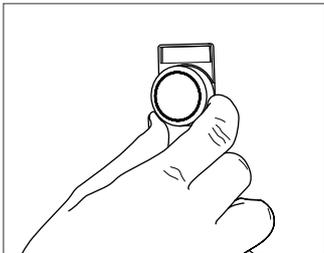

The operator is to be inserted from the front...

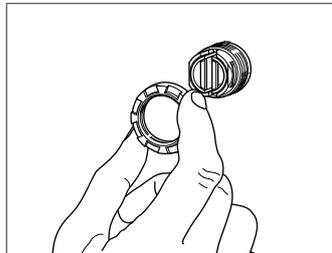

...and secured at the back with the nut.

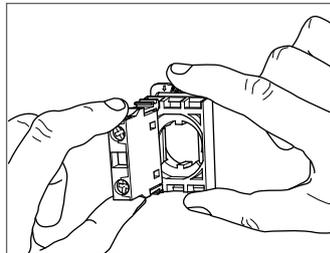

The contact blocks/LED block are then snapped on to the holder...

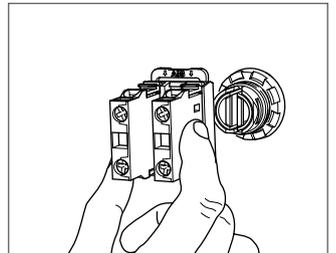

...and the holder snaps on to the operator.

...and to remove

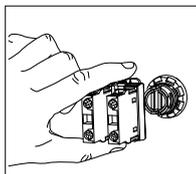
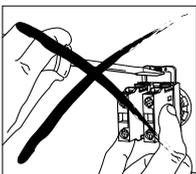

Press down the spring on the holder and pull the holder from the actuator.

Simple and fast installation



Watch the video

Modular plastic range

Non-illuminated flush pushbuttons



MP1-10R

1SFC151004V0001



MP1-10Y

1SFC151016V0001



MP1-30L

1SFC151031V0001



MP2-10G

1SFC151015V0001



MP2-10W

1SFC151018V0001



MP2-20B

1SFC151029V0001

Operator	Bezel	Type	Order code	Pkg qty	Weight (1 pce) kg
Momentary					
● Red	Black plastic	MP1-10R	1SFA611100R1001	1	0.016
	Chrome plastic	MP1-20R	1SFA611100R2001	1	0.016
	Chrome metal	MP1-30R	1SFA611100R3001	1	0.026
● Green	Black plastic	MP1-10G	1SFA611100R1002	1	0.016
	Chrome plastic	MP1-20G	1SFA611100R2002	1	0.016
	Chrome metal	MP1-30G	1SFA611100R3002	1	0.026
● Yellow	Black plastic	MP1-10Y	1SFA611100R1003	1	0.016
	Chrome plastic	MP1-20Y	1SFA611100R2003	1	0.016
	Chrome metal	MP1-30Y	1SFA611100R3003	1	0.026
● Blue	Black plastic	MP1-10L	1SFA611100R1004	1	0.016
	Chrome plastic	MP1-20L	1SFA611100R2004	1	0.016
	Chrome metal	MP1-30L	1SFA611100R3004	1	0.026
○ White	Black plastic	MP1-10W	1SFA611100R1005	1	0.016
	Chrome plastic	MP1-20W	1SFA611100R2005	1	0.016
	Chrome metal	MP1-30W	1SFA611100R3005	1	0.026
● Black	Black plastic	MP1-10B	1SFA611100R1006	1	0.016
	Chrome plastic	MP1-20B	1SFA611100R2006	1	0.016
	Chrome metal	MP1-30B	1SFA611100R3006	1	0.026
○ Clear	Black plastic	MP1-10C	1SFA611100R1008	1	0.016
	Chrome plastic	MP1-20C	1SFA611100R2008	1	0.016
	Chrome metal	MP1-30C	1SFA611100R3008	1	0.026
Maintained					
● Red	Black plastic	MP2-10R	1SFA611101R1001	1	0.016
	Chrome plastic	MP2-20R	1SFA611101R2001	1	0.016
	Chrome metal	MP2-30R	1SFA611101R3001	1	0.026
● Green	Black plastic	MP2-10G	1SFA611101R1002	1	0.016
	Chrome plastic	MP2-20G	1SFA611101R2002	1	0.016
	Chrome metal	MP2-30G	1SFA611101R3002	1	0.026
● Yellow	Black plastic	MP2-10Y	1SFA611101R1003	1	0.016
	Chrome metal	MP2-30Y	1SFA611101R3003	1	0.026
	● Blue	Black plastic	MP2-10L	1SFA611101R1004	1
Chrome plastic		MP2-20L	1SFA611101R2004	1	0.016
Chrome metal		MP2-30L	1SFA611101R3004	1	0.026
○ White	Black plastic	MP2-10W	1SFA611101R1005	1	0.016
	Chrome plastic	MP2-20W	1SFA611101R2005	1	0.016
	● Black	Black plastic	MP2-10B	1SFA611101R1006	1
Chrome plastic		MP2-20B	1SFA611101R2006	1	0.016
Chrome metal		MP2-30B	1SFA611101R3006	1	0.026
○ Clear	Black plastic	MP2-10C	1SFA611101R1008	1	0.016

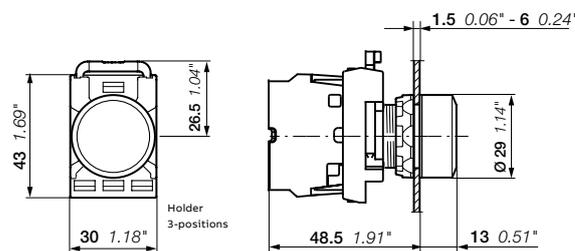

MP1, MP2
Dimensions (mm, inches)

Modular plastic range

Non-illuminated extended pushbuttons



MP3-10R

1SFC151006V0001



MP3-20Y

1SFC151028V0001



MP3-10W

1SFC151013V0001



MP3-10C

1SFC151333V0001



MP4-10G

1SFC151012V0001



MP4-10L

1SFC151019V0001



MP4-10B

1SFC151011V0001

Operator	Bezel	Type	Order code	Pkg qty	Weight (1 pce) kg
Momentary					
● Red	Black plastic	MP3-10R	1SFA611102R1001	1	0.016
	Chrome plastic	MP3-20R	1SFA611102R2001	1	0.016
	Chrome metal	MP3-30R	1SFA611102R3001	1	0.026
● Green	Black plastic	MP3-10G	1SFA611102R1002	1	0.016
	Chrome plastic	MP3-20G	1SFA611102R2002	1	0.016
	Chrome metal	MP3-30G	1SFA611102R3002	1	0.026
● Yellow	Black plastic	MP3-10Y	1SFA611102R1003	1	0.016
	Chrome plastic	MP3-20Y	1SFA611102R2003	1	0.016
	Chrome metal	MP3-30Y	1SFA611102R3003	1	0.026
● Blue	Black plastic	MP3-10L	1SFA611102R1004	1	0.016
	Chrome plastic	MP3-20L	1SFA611102R2004	1	0.016
	Chrome metal	MP3-30L	1SFA611102R3004	1	0.026
○ White	Black plastic	MP3-10W	1SFA611102R1005	1	0.016
	Chrome plastic	MP3-20W	1SFA611102R2005	1	0.016
	Chrome metal	MP3-30W	1SFA611102R3005	1	0.026
● Black	Black plastic	MP3-10B	1SFA611102R1006	1	0.016
	Chrome plastic	MP3-20B	1SFA611102R2006	1	0.016
	Chrome metal	MP3-30B	1SFA611102R3006	1	0.026
○ Clear	Black plastic	MP3-10C	1SFA611102R1008	1	0.016
	Chrome metal	MP3-30C	1SFA611102R3008	1	0.026
Maintained					
● Red	Black plastic	MP4-10R	1SFA611103R1001	1	0.016
	Chrome plastic	MP4-20R	1SFA611103R2001	1	0.016
● Green	Black plastic	MP4-10G	1SFA611103R1002	1	0.016
	Chrome plastic	MP4-20G	1SFA611103R2002	1	0.016
	Chrome metal	MP4-30G	1SFA611103R3002	1	0.026
● Yellow	Black plastic	MP4-10Y	1SFA611103R1003	1	0.016
	Chrome plastic	MP4-20Y	1SFA611103R2003	1	0.016
● Blue	Black plastic	MP4-10L	1SFA611103R1004	1	0.016
	Chrome plastic	MP4-20L	1SFA611103R2004	1	0.016
○ White	Black plastic	MP4-10W	1SFA611103R1005	1	0.016
● Black	Black plastic	MP4-10B	1SFA611103R1006	1	0.016
	Chrome metal	MP4-30B	1SFA611103R3006	1	0.026
○ Clear	Black plastic	MP4-10C	1SFA611103R1008	1	0.016

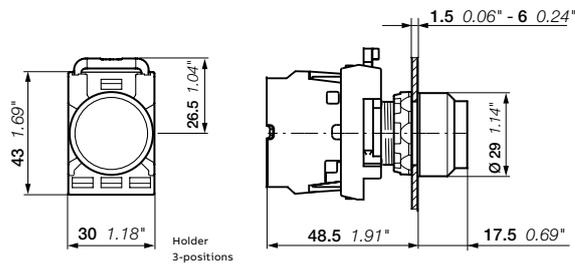

MP3, MP4
Dimensions (mm, inches)

Modular plastic range

Illuminated flush pushbuttons



MP1-31G

1SFCL51048V0001



MP1-11Y

1SFCL51042V0001



MP1-21L

1SFCL51046V0001



MP2-31R

1SFCL51046V0001



MP2-11L

1SFCL51040V0001



MP2-11C

1SFCL51044V0001

Operator	Bezel	Type	Order code	Pkg qty	Weight (1 pce) kg
Momentary					
● Red	Black plastic	MP1-11R	1SFA611100R1101	1	0.016
	Chrome plastic	MP1-21R	1SFA611100R2101	1	0.016
	Chrome metal	MP1-31R	1SFA611100R3101	1	0.026
● Green	Black plastic	MP1-11G	1SFA611100R1102	1	0.016
	Chrome plastic	MP1-21G	1SFA611100R2102	1	0.016
	Chrome metal	MP1-31G	1SFA611100R3102	1	0.026
● Yellow	Black plastic	MP1-11Y	1SFA611100R1103	1	0.016
	Chrome plastic	MP1-21Y	1SFA611100R2103	1	0.016
	Chrome metal	MP1-31Y	1SFA611100R3103	1	0.026
● Blue	Black plastic	MP1-11L	1SFA611100R1104	1	0.016
	Chrome plastic	MP1-21L	1SFA611100R2104	1	0.016
	Chrome metal	MP1-31L	1SFA611100R3104	1	0.026
○ White	Black plastic	MP1-11W	1SFA611100R1105	1	0.016
	Chrome plastic	MP1-21W	1SFA611100R2105	1	0.016
	Chrome metal	MP1-31W	1SFA611100R3105	1	0.026
○ Clear	Black plastic	MP1-11C	1SFA611100R1108	1	0.016
	Chrome plastic	MP1-21C	1SFA611100R2108	1	0.016
	Chrome metal	MP1-31C	1SFA611100R3108	1	0.026
Maintained					
● Red	Black plastic	MP2-11R	1SFA611101R1101	1	0.016
	Chrome plastic	MP2-21R	1SFA611101R2101	1	0.016
	Chrome metal	MP2-31R	1SFA611101R3101	1	0.026
● Green	Black plastic	MP2-11G	1SFA611101R1102	1	0.016
	Chrome plastic	MP2-21G	1SFA611101R2102	1	0.016
	Chrome metal	MP2-31G	1SFA611101R3102	1	0.026
● Yellow	Black plastic	MP2-11Y	1SFA611101R1103	1	0.016
	Chrome plastic	MP2-21Y	1SFA611101R2103	1	0.016
	Chrome metal	MP2-31Y	1SFA611101R3103	1	0.026
● Blue	Black plastic	MP2-11L	1SFA611101R1104	1	0.016
	Chrome plastic	MP2-21L	1SFA611101R2104	1	0.016
	Chrome metal	MP2-31L	1SFA611101R3104	1	0.026
○ White	Black plastic	MP2-11W	1SFA611101R1105	1	0.016
	Chrome plastic	MP2-21W	1SFA611101R2105	1	0.016
	Chrome metal	MP2-31W	1SFA611101R3105	1	0.026
○ Clear	Black plastic	MP2-11C	1SFA611101R1108	1	0.016
	Chrome plastic	MP2-21C	1SFA611101R2108	1	0.016
	Chrome metal	MP2-31C	1SFA611101R3108	1	0.026

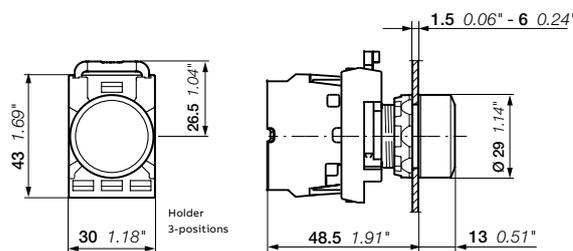

MP1, MP2

Dimensions (mm, inches)

Modular plastic range

Illuminated extended pushbuttons



MP3-11R

1SFCL51065V0001



MP3-31G

1SFCL51062V0001



MP3-11W

1SFCL51072V0001



MP4-11Y

1SFCL51083V0001



MP4-31L

1SFCL51061V0001



MP4-21C

1SFCL51067V0001

Operator	Bezel	Type	Order code	Pkg qty	Weight (1 pce) kg
Momentary					
● Red	Black plastic	MP3-11R	1SFA611102R1101	1	0.016
	Chrome plastic	MP3-21R	1SFA611102R2101	1	0.016
	Chrome metal	MP3-31R	1SFA611102R3101	1	0.026
● Green	Black plastic	MP3-11G	1SFA611102R1102	1	0.016
	Chrome plastic	MP3-21G	1SFA611102R2102	1	0.016
	Chrome metal	MP3-31G	1SFA611102R3102	1	0.026
● Yellow	Black plastic	MP3-11Y	1SFA611102R1103	1	0.016
	Chrome plastic	MP3-21Y	1SFA611102R2103	1	0.016
	Chrome metal	MP3-31Y	1SFA611102R3103	1	0.026
● Blue	Black plastic	MP3-11L	1SFA611102R1104	1	0.016
	Chrome plastic	MP3-21L	1SFA611102R2104	1	0.016
	Chrome metal	MP3-31L	1SFA611102R3104	1	0.026
○ White	Black plastic	MP3-11W	1SFA611102R1105	1	0.016
	Chrome plastic	MP3-21W	1SFA611102R2105	1	0.016
	Chrome metal	MP3-31W	1SFA611102R3105	1	0.026
○ Clear	Black plastic	MP3-11C	1SFA611102R1108	1	0.016
	Chrome plastic	MP3-21C	1SFA611102R2108	1	0.016
	Chrome metal	MP3-31C	1SFA611102R3108	1	0.026
Maintained					
● Red	Black plastic	MP4-11R	1SFA611103R1101	1	0.016
	Chrome plastic	MP4-21R	1SFA611103R2101	1	0.016
	Chrome metal	MP4-31R	1SFA611103R3101	1	0.026
● Green	Black plastic	MP4-11G	1SFA611103R1102	1	0.016
	Chrome plastic	MP4-21G	1SFA611103R2102	1	0.016
	Chrome metal	MP4-31G	1SFA611103R3102	1	0.026
● Yellow	Black plastic	MP4-11Y	1SFA611103R1103	1	0.016
	Chrome plastic	MP4-21Y	1SFA611103R2103	1	0.016
● Blue	Black plastic	MP4-11L	1SFA611103R1104	1	0.016
	Chrome plastic	MP4-21L	1SFA611103R2104	1	0.016
	Chrome metal	MP4-31L	1SFA611103R3104	1	0.026
○ White	Black plastic	MP4-11W	1SFA611103R1105	1	0.016
	Chrome plastic	MP4-21W	1SFA611103R2105	1	0.016
○ Clear	Black plastic	MP4-11C	1SFA611103R1108	1	0.016
	Chrome plastic	MP4-21C	1SFA611103R2108	1	0.016
	Chrome metal	MP4-31C	1SFA611103R3108	1	0.026

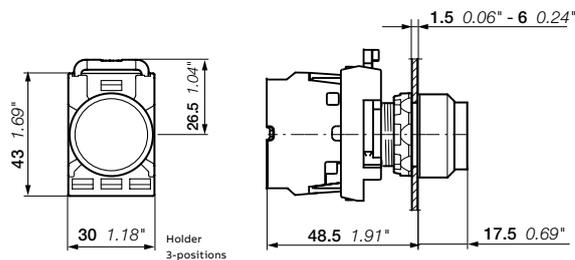

MP3, MP4

Dimensions (mm, inches)

Modular plastic range

Non-illuminated double pushbuttons momentary



MPD1-11B



MPD5-11B



MPD13-11B



MPD15-11B



MA1-8139

Operator upper button	Operator lower button	Type	Order code	Pkg qty	Weight (1 pce) kg
Flush pushbutton					
● Green	● Red				
No text	No text	MPD1-11B	1SFA611130R1106	1	0.025
I	0	MPD2-11B	1SFA611131R1106	1	0.025
ON	OFF	MPD3-11B	1SFA611132R1106	1	0.025
START	STOP	MPD4-11B	1SFA611133R1106	1	0.025
○ White	● Black				
No text	No text	MPD5-11B	1SFA611134R1106	1	0.025
I	0	MPD6-11B	1SFA611135R1106	1	0.025
ON	OFF	MPD7-11B	1SFA611136R1106	1	0.025
START	STOP	MPD8-11B	1SFA611137R1106	1	0.025
● Black	● Red				
No text	No text	MPD9-11B	1SFA611138R1106	1	0.025
Extended lower pushbutton					
● Green	● Red				
No text	No text	MPD12-11B	1SFA611141R1106	1	0.025
I	0	MPD13-11B	1SFA611142R1106	1	0.025
ON	OFF	MPD14-11B	1SFA611143R1106	1	0.025
START	STOP	MPD15-11B	1SFA611144R1106	1	0.025
○ White	● Black				
No text	No text	MPD16-11B	1SFA611145R1106	1	0.025
I	0	MPD17-11B	1SFA611146R1106	1	0.025
ON	OFF	MPD18-11B	1SFA611147R1106	1	0.025
START	STOP	MPD19-11B	1SFA611148R1106	1	0.025
Accessories					
Legend plate holder					
2-position		MA1-8139	1SFA611920R8139	10	0.030

Note: Insert not included. Suitable for insert size 27 x 15 mm. Refer to Legend plates section.

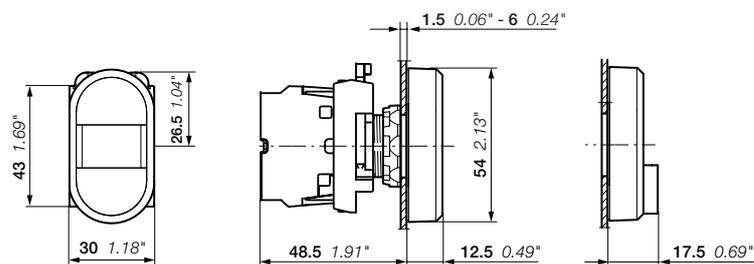

MPD
Dimensions (mm, inches)

Modular plastic range

Illuminated double pushbuttons momentary - Flush lower button



MPD4-11C

1SFC151088V0001



MPD5-11C

1SFC151100V0001



MPD2-11R

1SFC151078V0001



MDP3-11G

1SFC151083V0001



MA1-8139

1SFC15134F0001

Operator upper button	Operator lower button	Type	Order code	Pkg qty	Weight (1 pce) kg
-----------------------	-----------------------	------	------------	---------	-------------------

Clear light indicator

● Green		● Red			
No text	No text	MPD1-11C	1SFA611130R1108	1	0.025
I	0	MPD2-11C	1SFA611131R1108	1	0.025
ON	OFF	MPD3-11C	1SFA611132R1108	1	0.025
START	STOP	MPD4-11C	1SFA611133R1108	1	0.025
○ White		● Black			
No text	No text	MPD5-11C	1SFA611134R1108	1	0.025
I	0	MPD6-11C	1SFA611135R1108	1	0.025
START	STOP	MPD8-11C	1SFA611137R1108	1	0.025

Red light indicator

● Green		● Red			
No text	No text	MPD1-11R	1SFA611130R1101	1	0.025
I	0	MPD2-11R	1SFA611131R1101	1	0.025
ON	OFF	MPD3-11R	1SFA611132R1101	1	0.025
START	STOP	MPD4-11R	1SFA611133R1101	1	0.025
○ White		● Black			
No text	No text	MPD5-11R	1SFA611134R1101	1	0.025

Green light indicator

● Green		● Red			
No text	No text	MPD1-11G	1SFA611130R1102	1	0.025
I	0	MPD2-11G	1SFA611131R1102	1	0.025
ON	OFF	MPD3-11G	1SFA611132R1102	1	0.025
START	STOP	MPD4-11G	1SFA611133R1102	1	0.025
○ White		● Black			
No text	No text	MPD5-11G	1SFA611134R1102	1	0.025
I	0	MPD6-11G	1SFA611135R1102	1	0.025
ON	OFF	MPD7-11G	1SFA611136R1102	1	0.025
START	STOP	MPD8-11G	1SFA611137R1102	1	0.025

Yellow light indicator

● Green		● Red			
No text	No text	MPD1-11Y	1SFA611130R1103	1	0.025
I	0	MPD2-11Y	1SFA611131R1103	1	0.025
ON	OFF	MPD3-11Y	1SFA611132R1103	1	0.025
START	STOP	MPD4-11Y	1SFA611133R1103	1	0.025
○ White		● Black			
No text	No text	MPD5-11Y	1SFA611134R1103	1	0.025

Accessories

Legend plate holder

2-position	MA1-8139	1SFA611920R8139	10	0.030
------------	----------	-----------------	----	-------

Note: Insert not included. Suitable for insert size 27 x 15 mm. Refer to Legend plates section.

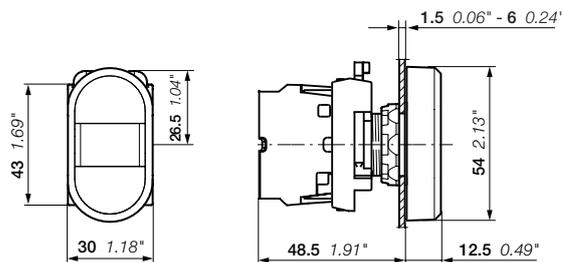

MPD
Dimensions (mm, inches)

Modular plastic range

Illuminated double pushbuttons momentary - Extended lower button



MPD12-11C



MPD14-11C



MDP13-11R



MDP14-11G



MDP12-11Y



MA1-8139

Operator upper button	Operator lower button	Type	Order code	Pkg qty	Weight (1 pce) kg
-----------------------	-----------------------	------	------------	---------	-------------------

Clear light indicator

Green	Red				
No text	No text	MPD12-11C	1SFA611141R1108	1	0.025
I	0	MPD13-11C	1SFA611142R1108	1	0.025
ON	OFF	MPD14-11C	1SFA611143R1108	1	0.025
START	STOP	MPD15-11C	1SFA611144R1108	1	0.025

White	Black				
No text	No text	MPD16-11C	1SFA611145R1108	1	0.025
I	0	MPD17-11C	1SFA611146R1108	1	0.025
START	STOP	MPD19-11C	1SFA611148R1108	1	0.025

Red light indicator

Green	Red				
No text	No text	MPD12-11R	1SFA611141R1101	1	0.025
I	0	MPD13-11R	1SFA611142R1101	1	0.025
ON	OFF	MPD14-11R	1SFA611143R1101	1	0.025
START	STOP	MPD15-11R	1SFA611144R1101	1	0.025

White	Black				
No text	No text	MPD16-11R	1SFA611145R1101	1	0.025

Green light indicator

Green	Red				
No text	No text	MPD12-11G	1SFA611141R1102	1	0.025
I	0	MPD13-11G	1SFA611142R1102	1	0.025
ON	OFF	MPD14-11G	1SFA611143R1102	1	0.025
START	STOP	MPD15-11G	1SFA611144R1102	1	0.025

White	Black				
No text	No text	MPD16-11G	1SFA611145R1102	1	0.025
I	0	MPD17-11G	1SFA611146R1102	1	0.025
START	STOP	MPD19-11G	1SFA611148R1102	1	0.025

Yellow light indicator

Green	Red				
No text	No text	MPD12-11Y	1SFA611141R1103	1	0.025
I	0	MPD13-11Y	1SFA611142R1103	1	0.025
ON	OFF	MPD14-11Y	1SFA611143R1103	1	0.025
START	STOP	MPD15-11Y	1SFA611144R1103	1	0.025

White	Black				
No text	No text	MPD16-11Y	1SFA611145R1103	1	0.025
I	0	MPD17-11Y	1SFA611146R1103	1	0.025

Accessories

Legend plate holder

2-position	MA1-8139	1SFA611920R8139	10	0.030
------------	----------	-----------------	----	-------

Note: Insert not included. Suitable for insert size 27 x 15 mm. Refer to Legend plates section.

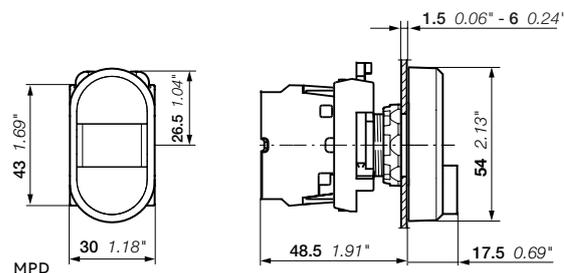

Modular plastic range

Mushroom pushbuttons momentary

02



1SFC151007V0001

MPM1-10G



1SFC151010V0001

MPM1-10B



1SFC151073V0001

MPM2-10R



1SFC151074V0001

MPM2-10Y



1SFC151173V0001

MPM1-11G



1SFC151155V0001

MPM2-11R

Non illuminated

Operator	Type	Order code	Pkg qty	Weight (1 pce) kg
Ø 40 mm				
● Red	MPM1-10R	1SFA611124R1001	1	0.018
● Green	MPM1-10G	1SFA611124R1002	1	0.018
● Yellow	MPM1-10Y	1SFA611124R1003	1	0.018
● Black	MPM1-10B	1SFA611124R1006	1	0.018
Ø 60 mm				
● Red	MPM2-10R	1SFA611125R1001	1	0.020
● Yellow	MPM2-10Y	1SFA611125R1003	1	0.020
● Black	MPM2-10B	1SFA611125R1006	1	0.020

Illuminated

Operator	Type	Order code	Pkg qty	Weight (1 pce) kg
Ø 40 mm				
● Red	MPM1-11R	1SFA611124R1101	1	0.018
● Green	MPM1-11G	1SFA611124R1102	1	0.018
● Yellow	MPM1-11Y	1SFA611124R1103	1	0.018
Ø 60 mm				
● Red	MPM2-11R	1SFA611125R1101	1	0.020
● Yellow	MPM2-11Y	1SFA611125R1103	1	0.020

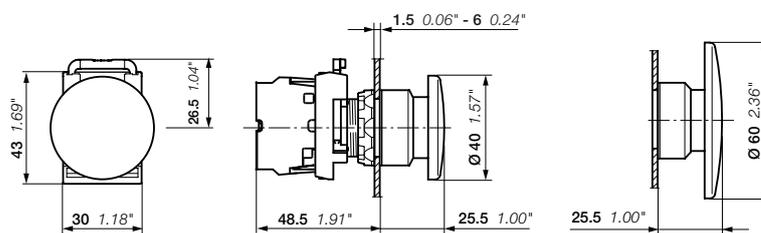

MPM1, MPM2
Dimensions (mm, inches)

Modular plastic range

Emergency stop pushbuttons

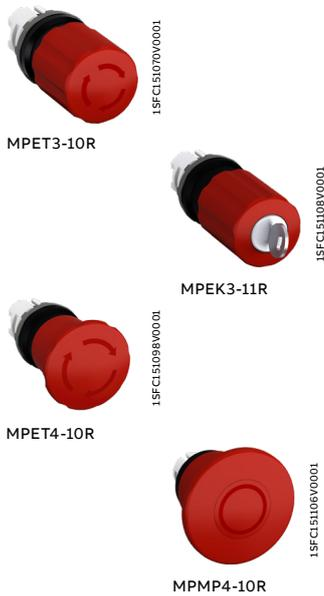

Non illuminated

The emergency stops pushbuttons conform to the standard EN/IEC 60947-5-5, Safety of machinery EN/ISO 13850, IEC 60204-1 and to Machinery directive 2006/42/EC.

Operator	Release method	Type	Order code	Pkg qty	Weight (1 pce) kg
Ø 30 mm					
● Red	Twist release	MPET3-10R	1SFA611520R1001	1	0.036
● Red	Pull release	MPEP3-10R	1SFA611521R1001	1	0.036
● Red	Key code 455	MPEK3-11R	1SFA611522R1101	1	0.065
● Red	Key code 421	MPEK3-12R	1SFA611522R1201	1	0.065
● Red	Key code 3433-E	MPEK3-13R	1SFA611522R1301	1	0.065
Ø 40 mm					
● Red	Twist release	MPET4-10R	1SFA611523R1001	1	0.036
● Red	Pull release	MPEP4-10R	1SFA611524R1001	1	0.036
● Red	Key code 455	MPEK4-11R	1SFA611525R1101	1	0.065
● Red	Key code 421	MPEK4-12R	1SFA611525R1201	1	0.065
● Red	Key code 3433-E	MPEK4-13R	1SFA611525R1301	1	0.065
Ø 60 mm					
● Red	Twist release	MPMT4-10R	1SFA611513R1001	1	0.048
● Red	Pull release	MPMP4-10R	1SFA611514R1001	1	0.048

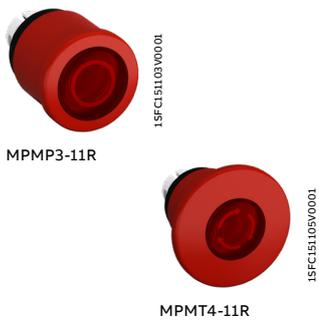

Illuminated

Operator	Release method	Type	Order code	Pkg qty	Weight (1 pce) kg
Ø 40 mm					
● Red	Twist release	MPMT3-11R	1SFA611510R1101	1	0.041
● Red	Pull release	MPMP3-11R	1SFA611511R1101	1	0.041
Ø 60 mm					
● Red	Twist release	MPMT4-11R	1SFA611513R1101	1	0.048
● Red	Pull release	MPMP4-11R	1SFA611514R1101	1	0.048

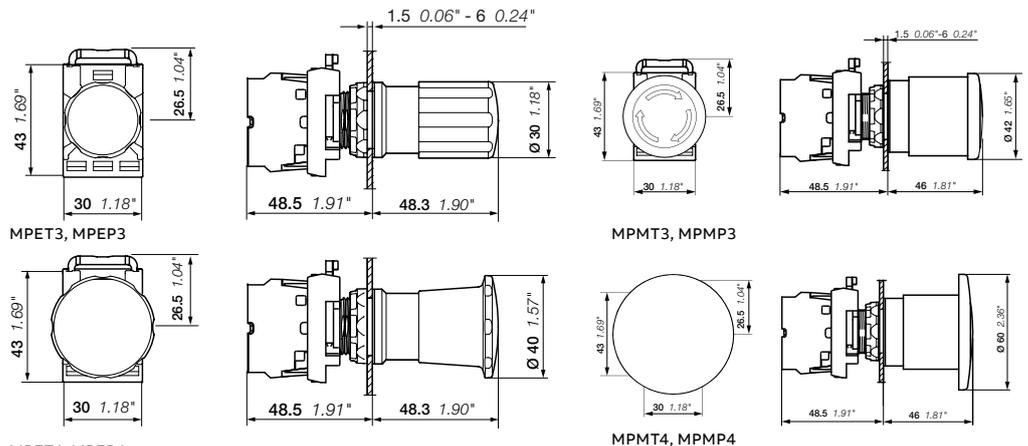

Dimensions (mm, inches)

Modular plastic range

Machine stop pushbuttons



1SFC151094V0001

MPET3-10B



1SFC151096V0001

MPET4-10B



1SFC15110V0001

MPEK4-11B

Non illuminated

Operator	Release method	Type	Order code	Pkg qty	Weight (1 pce) kg
Ø 30 mm					
● Black	Twist release	MPET3-10B	1SFA611520R1006	1	0.036
● Black	Pull release	MPEP3-10B	1SFA611521R1006	1	0.036
● Black	Key code 455	MPEK3-11B	1SFA611522R1106	1	0.065
Ø 40 mm					
● Black	Twist release	MPET4-10B	1SFA611523R1006	1	0.036
● Black	Pull release	MPEP4-10B	1SFA611524R1006	1	0.036
● Black	Key code 455	MPEK4-11B	1SFA611525R1106	1	0.065

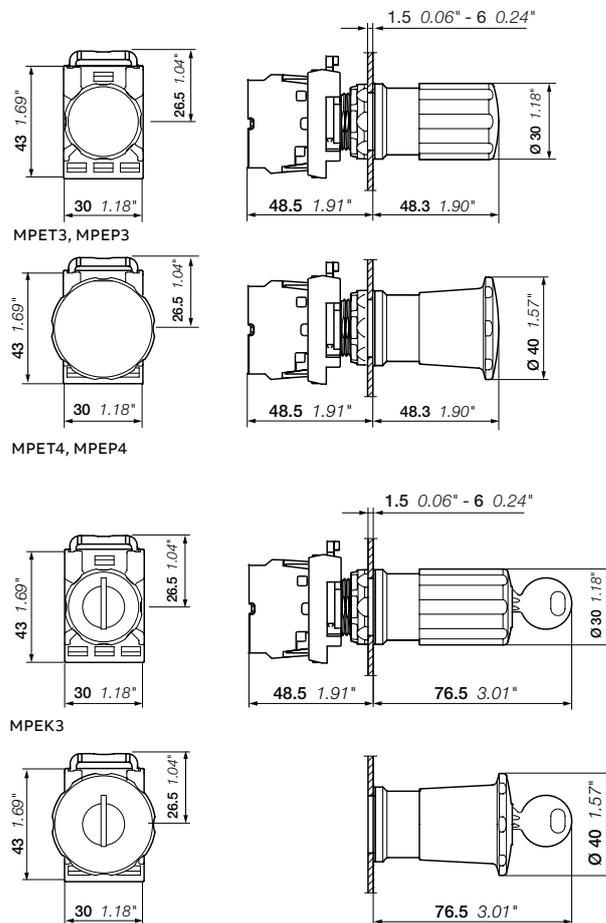

Dimensions (mm, inches)

Modular plastic range

Heavy duty pushbuttons



KP6-40R

1SFC15133V0001



KP6-40G

1SFC151336V0001



KP6-40B

1SFC151337V0001

Description

For 30 mm mounting hole, 3-position holder included

Color	Type	Order code	Pkg qty	Weight (1 pce) kg
● Red	KP6-40R	1SFA616105R4001	1	0.028
● Green	KP6-40G	1SFA616105R4002	1	0.028
● Black	KP6-40B	1SFA616105R4006	1	0.028

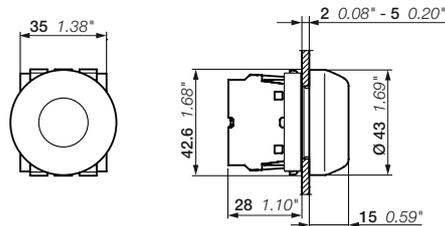

KP6

Modular plastic range

Pilot lights



ML1-100R

1SFC151134V0001



ML1-100G

1SFC151135V0001



ML1-100Y

1SFC151136V0001



ML1-100C

1SFC151138V0001



ML1-100L

1SFC151137V0001

Color	Type	Order code	Pkg qty	Weight (1 pce) kg
● Red	ML1-100R	1SFA611400R1001	1	0.018
● Green	ML1-100G	1SFA611400R1002	1	0.018
● Yellow	ML1-100Y	1SFA611400R1003	1	0.018
● Blue	ML1-100L	1SFA611400R1004	1	0.018
○ White	ML1-100W	1SFA611400R1005	1	0.018
○ Clear	ML1-100C	1SFA611400R1008	1	0.018

Lens

Light diffusing lens	Order code	Pkg qty	Weight (1 pce) kg
KA1-8005	1SFA616920R8005	10	0.001

Note: Light diffusing lens is used to improve spread of illumination from LED blocks. Cannot be used together with text cap.

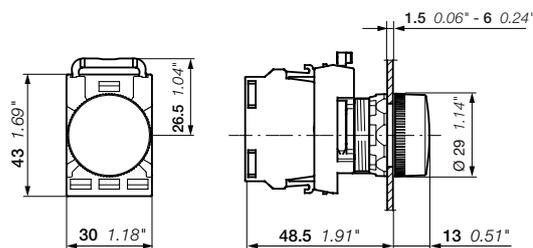

ML1

Dimensions (mm, inches)

Modular plastic range

Non-illuminated selector switches - 2-position - Short handle



Operating principle	Color	Bezel	Type	Order code	Pkg qty	Weight (1 pce) kg	
	● Red	Black plastic	M2SS1-10R	1SFA611200R1001	1	0.015	
		Chrome plastic	M2SS1-20R	1SFA611200R2001	1	0.015	
		Chrome metal	M2SS1-30R	1SFA611200R3001	1	0.024	
	● Black	Black plastic	M2SS1-10B	1SFA611200R1006	1	0.015	
		Chrome plastic	M2SS1-20B	1SFA611200R2006	1	0.015	
		Chrome metal	M2SS1-30B	1SFA611200R3006	1	0.024	
● Grey	Black plastic	M2SS1-10U	1SFA611200R1007	1	0.015		
	Chrome plastic	M2SS1-20U	1SFA611200R2007	1	0.015		
	● Red	Black plastic	M2SS2-10R	1SFA611201R1001	1	0.015	
		Chrome plastic	M2SS2-20R	1SFA611201R2001	1	0.015	
		Chrome metal	M2SS2-30R	1SFA611201R3001	1	0.024	
	● Black	Black plastic	M2SS2-10B	1SFA611201R1006	1	0.015	
		Chrome plastic	M2SS2-20B	1SFA611201R2006	1	0.015	
		Chrome metal	M2SS2-30B	1SFA611201R3006	1	0.024	
	● Grey	Black plastic	M2SS2-10U	1SFA611201R1007	1	0.015	
		Chrome plastic	M2SS2-20U	1SFA611201R2007	1	0.015	
		Chrome metal	M2SS2-30U	1SFA611201R3007	1	0.024	
		● Red	Black plastic	M2SS3-10R	1SFA611202R1001	1	0.015
			Chrome plastic	M2SS3-20R	1SFA611202R2001	1	0.015
			Chrome metal	M2SS3-30R	1SFA611202R3001	1	0.024
● Black		Black plastic	M2SS3-10B	1SFA611202R1006	1	0.015	
		Chrome plastic	M2SS3-20B	1SFA611202R2006	1	0.015	
		Chrome metal	M2SS3-30B	1SFA611202R3006	1	0.024	
● Grey	Black plastic	M2SS3-10U	1SFA611202R1007	1	0.015		
	Chrome plastic	M2SS3-20U	1SFA611202R2007	1	0.015		

Contacts actuated

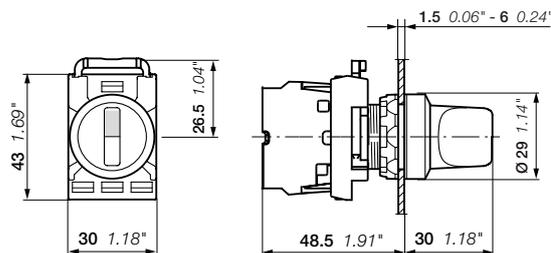
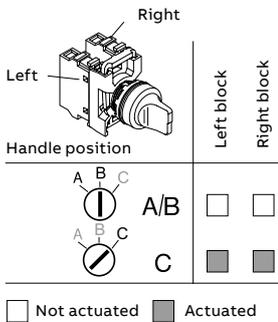

M2SS
Dimensions (mm, inches)

Modular plastic range

Non-illuminated selector switches - 2-position - Long handle



M2SS4-10R



M2SS4-30B



M2SS4-10U

Operating principle	Color	Bezel	Type	Order code	Pkg qty	Weight (1 pce) kg
	● Red	Black plastic	M2SS4-10R	1SFA611203R1001	1	0.018
		Chrome plastic	M2SS4-20R	1SFA611203R2001	1	0.018
	● Black	Black plastic	M2SS4-10B	1SFA611203R1006	1	0.018
		Chrome plastic	M2SS4-20B	1SFA611203R2006	1	0.018
	● Grey	Chrome metal	M2SS4-30B	1SFA611203R3006	1	0.027
		Black plastic	M2SS4-10U	1SFA611203R1007	1	0.018
	● Red	Black plastic	M2SS5-10R	1SFA611204R1001	1	0.018
		Chrome plastic	M2SS5-20R	1SFA611204R2001	1	0.018
		Chrome metal	M2SS5-30R	1SFA611204R3001	1	0.027
	● Black	Black plastic	M2SS5-10B	1SFA611204R1006	1	0.018
		Chrome plastic	M2SS5-20B	1SFA611204R2006	1	0.018
		Chrome metal	M2SS5-30B	1SFA611204R3006	1	0.027
● Grey	Black plastic	M2SS5-10U	1SFA611204R1007	1	0.018	
	Chrome plastic	M2SS5-20U	1SFA611204R2007	1	0.018	
		● Red	Black plastic	M2SS6-10R	1SFA611205R1001	1
Black plastic			M2SS6-10B	1SFA611205R1006	1	0.018
Chrome plastic			M2SS6-20B	1SFA611205R2006	1	0.018
● Black		Chrome metal	M2SS6-30B	1SFA611205R3006	1	0.027
		Black plastic	M2SS6-10U	1SFA611205R1007	1	0.018
		Chrome plastic	M2SS6-20U	1SFA611205R2007	1	0.018

Contacts actuated

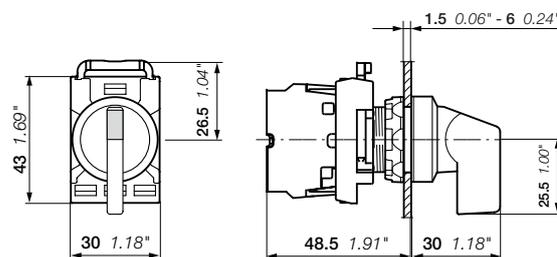
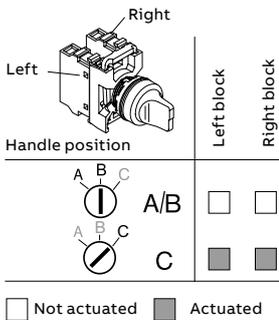

M2SS

Dimensions (mm, inches)

Modular plastic range

Non-illuminated selector switches - 3-position - Short handle



Contacts actuated

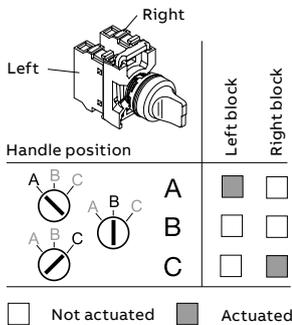

Operating principle	Color	Bezel	Type	Order code	Pkg qty	Weight (1 pce) kg
	● Red	Black plastic	M3SS1-10R	1SFA611210R1001	1	0.015
		Chrome plastic	M3SS1-20R	1SFA611210R2001	1	0.015
		Chrome metal	M3SS1-30R	1SFA611210R3001	1	0.024
	● Black	Black plastic	M3SS1-10B	1SFA611210R1006	1	0.015
		Chrome plastic	M3SS1-20B	1SFA611210R2006	1	0.015
		Chrome metal	M3SS1-30B	1SFA611210R3006	1	0.024
	● Grey	Black plastic	M3SS1-10U	1SFA611210R1007	1	0.015
		Chrome plastic	M3SS1-20U	1SFA611210R2007	1	0.015
		Chrome metal	M3SS1-30U	1SFA611210R3007	1	0.024
	● Red	Black plastic	M3SS2-10R	1SFA611211R1001	1	0.015
		Chrome plastic	M3SS2-20R	1SFA611211R2001	1	0.015
		Chrome metal	M3SS2-30R	1SFA611211R3001	1	0.024
	● Black	Black plastic	M3SS2-10B	1SFA611211R1006	1	0.015
		Chrome plastic	M3SS2-20B	1SFA611211R2006	1	0.015
		Chrome metal	M3SS2-30B	1SFA611211R3006	1	0.024
	● Grey	Black plastic	M3SS2-10U	1SFA611211R1007	1	0.015
		Chrome plastic	M3SS2-20U	1SFA611211R2007	1	0.015
		Chrome metal	M3SS2-30U	1SFA611211R3007	1	0.024
	● Red	Black plastic	M3SS3-10R	1SFA611212R1001	1	0.015
		Chrome plastic	M3SS3-20R	1SFA611212R2006	1	0.015
		Chrome metal	M3SS3-30R	1SFA611212R3006	1	0.024
	● Black	Black plastic	M3SS3-10B	1SFA611212R1006	1	0.015
		Chrome plastic	M3SS3-20B	1SFA611212R2006	1	0.015
		Chrome metal	M3SS3-30B	1SFA611212R3006	1	0.024
	● Grey	Black plastic	M3SS3-10U	1SFA611212R1007	1	0.015
		Chrome plastic	M3SS3-20U	1SFA611212R2007	1	0.015
		Chrome metal	M3SS3-30U	1SFA611212R3007	1	0.024
	● Red	Black plastic	M3SS7-10R	1SFA611216R1001	1	0.015
		Chrome plastic	M3SS7-20R	1SFA611216R2001	1	0.015
		Chrome metal	M3SS7-30R	1SFA611216R3006	1	0.024
	● Black	Black plastic	M3SS7-10B	1SFA611216R1006	1	0.015
		Chrome plastic	M3SS7-20B	1SFA611216R2006	1	0.015
		Chrome metal	M3SS7-30B	1SFA611216R3006	1	0.024
	● Grey	Black plastic	M3SS7-10U	1SFA611216R1007	1	0.015
		Chrome plastic	M3SS7-20U	1SFA611216R2007	1	0.015
		Chrome metal	M3SS7-30U	1SFA611216R3007	1	0.024

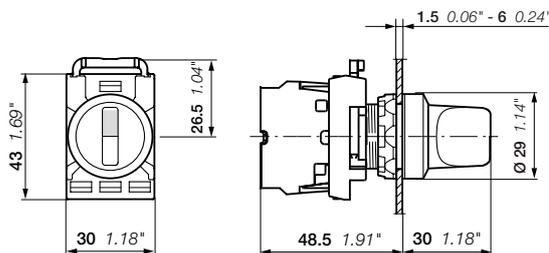

M3SS
Dimensions (mm, inches)

Modular plastic range

Non-illuminated selector switches - 3-position - Long handle



M3SS4-10R



M3SS5-30B



M3SS6-10U

Operating principle	Color	Bezel	Type	Order code	Pkg qty	Weight (1 pce) kg
	● Red	Black plastic	M3SS4-10R	1SFA611213R1001	1	0.018
		Chrome plastic	M3SS4-20R	1SFA611213R2001	1	0.018
	● Black	Black plastic	M3SS4-10B	1SFA611213R1006	1	0.018
		Chrome plastic	M3SS4-20B	1SFA611213R2006	1	0.018
	● Grey	Chrome metal	M3SS4-30B	1SFA611213R3006	1	0.027
		Black plastic	M3SS4-10U	1SFA611213R1007	1	0.018
	● Red	Black plastic	M3SS5-10R	1SFA611214R1001	1	0.018
		Chrome metal	M3SS5-30R	1SFA611214R3001	1	0.018
	● Black	Black plastic	M3SS5-10B	1SFA611214R1006	1	0.018
		Chrome plastic	M3SS5-20B	1SFA611214R2006	1	0.018
	● Grey	Chrome metal	M3SS5-30B	1SFA611214R3006	1	0.027
		Black plastic	M3SS5-10U	1SFA611214R1007	1	0.018
	● Red	Black plastic	M3SS6-10R	1SFA611215R1001	1	0.018
		Black plastic	M3SS6-10B	1SFA611215R1006	1	0.018
	● Black	Chrome plastic	M3SS6-20B	1SFA611215R2006	1	0.018
		Chrome metal	M3SS6-30B	1SFA611215R3006	1	0.027
	● Grey	Black plastic	M3SS6-10U	1SFA611215R1007	1	0.018
		Black plastic	M3SS8-10R	1SFA611217R1001	1	0.018
	● Black	Black plastic	M3SS8-10B	1SFA611217R1006	1	0.018
		Chrome plastic	M3SS8-20B	1SFA611217R2006	1	0.018
	● Grey	Chrome metal	M3SS8-30B	1SFA611217R3006	1	0.027
		Black plastic	M3SS8-10U	1SFA611217R1007	1	0.018

Contacts actuated

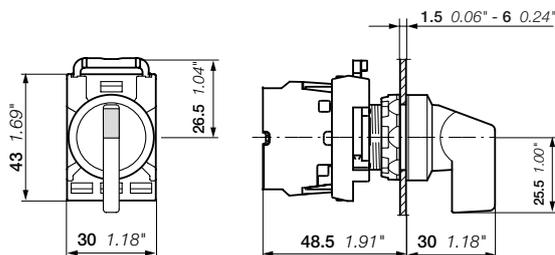
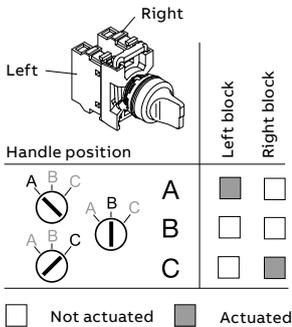

M3SS
Dimensions (mm, inches)

Modular plastic range

Non-illuminated selector switches - 3-position - Short handle



M3SSC1-10B



M3SSC3-30B

Center block operating

Operating principle	Color	Bezel	Type	Order code	Pkg qty	Weight (1 pce) kg
	● Black	Black plastic	M3SSC1-10B	1SFA611250R1006	1	0.015
		Chrome metal	M3SSC1-30B	1SFA611250R3006	1	0.024
	● Black	Black plastic	M3SSC2-10B	1SFA611251R1006	1	0.015
		Chrome metal	M3SSC2-30B	1SFA611251R3006	1	0.024
	● Black	Black plastic	M3SSC3-10B	1SFA611252R1006	1	0.015
		Chrome metal	M3SSC3-30B	1SFA611252R3006	1	0.024
	● Black	Black plastic	M3SSC7-10B	1SFA611256R1006	1	0.015
		Chrome metal	M3SSC7-30B	1SFA611256R3006	1	0.024

Contacts actuated

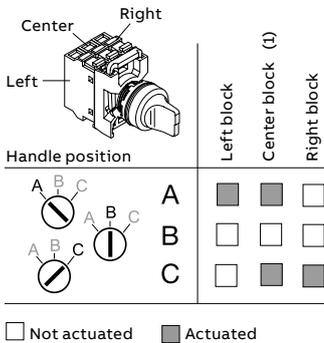

(1) To connect 3 separate circuits, one to each position ABC, use 1 NO in left position and right position and 1 NC in center position.

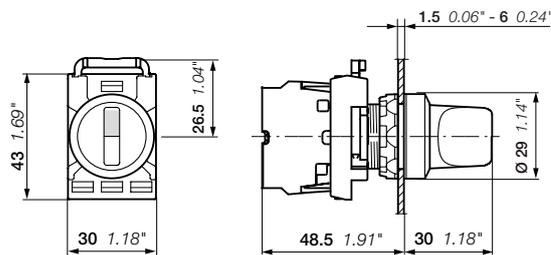

M3SSC

Dimensions (mm, inches)

Modular range

Non-illuminated selector switches - 4-position



4 position holder included. Contact blocks need to order separately.

Operating principle	Color	Bezel	Type	Order code	Pkg qty	Weight (1 pce) kg
Short handle						
● Red	Black plastic	M4SS1-10R	1SFA611290R4001	1	0.027	
	Chrome metal	M4SS1-30R	1SFA611290R6001	1	0.036	
● Black	Black plastic	M4SS1-10B	1SFA611290R4006	1	0.027	
	Chrome metal	M4SS1-30B	1SFA611290R6006	1	0.036	
Long handle						
● Red	Black plastic	M4SS2-10R	1SFA611291R4001	1	0.030	
	Chrome metal	M4SS2-30R	1SFA611291R6001	1	0.039	
● Black	Black plastic	M4SS2-10B	1SFA611291R4006	1	0.030	
	Chrome metal	M4SS2-30B	1SFA611291R6006	1	0.039	

Contacts actuated

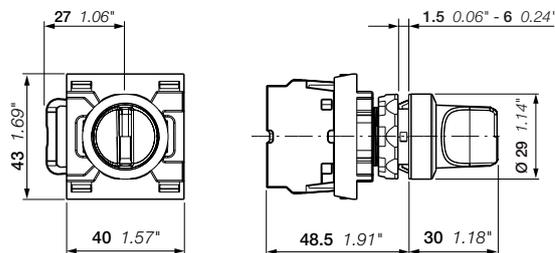
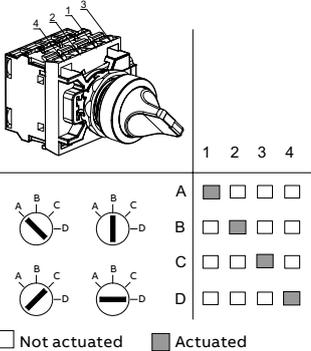

M4SS Short handle

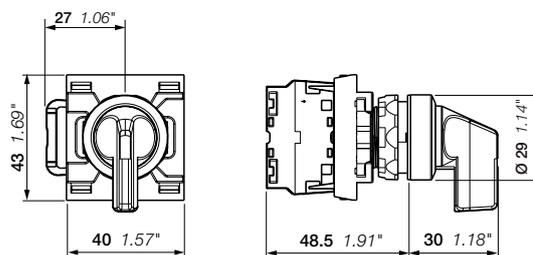

M4SS Long handle

Dimensions (mm, inches)

Modular plastic range

Illuminated selector switches - 2-position - Short handle



M2SS1-11R



M2SS1-31G



M2SS2-11Y

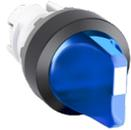

M2SS2-11L



M2SS3-11C

Contacts actuated

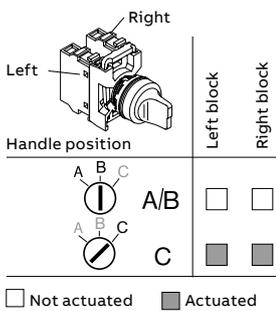

Operating principle	Color	Bezel	Type	Order code	Pkg qty	Weight (1 pce) kg
	● Red	Black plastic	M2SS1-11R	1SFA611200R1101	1	0.015
		Chrome plastic	M2SS1-21R	1SFA611200R2101	1	0.015
		Chrome metal	M2SS1-31R	1SFA611200R3101	1	0.024
	● Green	Black plastic	M2SS1-11G	1SFA611200R1102	1	0.015
		Chrome plastic	M2SS1-21G	1SFA611200R2102	1	0.015
		Chrome metal	M2SS1-31G	1SFA611200R3102	1	0.024
	● Yellow	Black plastic	M2SS1-11Y	1SFA611200R1103	1	0.015
		Chrome plastic	M2SS1-21Y	1SFA611200R2103	1	0.015
		Chrome metal	M2SS1-31Y	1SFA611200R3103	1	0.024
	● Blue	Black plastic	M2SS1-11L	1SFA611200R1104	1	0.015
		Chrome plastic	M2SS1-21L	1SFA611200R2104	1	0.015
		Chrome metal	M2SS1-31L	1SFA611200R3104	1	0.024
○ Clear	Black plastic	M2SS1-11C	1SFA611200R1108	1	0.015	
	Chrome plastic	M2SS1-21C	1SFA611200R2108	1	0.015	
	Chrome metal	M2SS1-31C	1SFA611200R3108	1	0.024	
	● Red	Black plastic	M2SS2-11R	1SFA611201R1101	1	0.015
		Chrome plastic	M2SS2-21R	1SFA611201R2101	1	0.015
		Chrome metal	M2SS2-31R	1SFA611201R3101	1	0.024
	● Green	Black plastic	M2SS2-11G	1SFA611201R1102	1	0.015
		Chrome plastic	M2SS2-21G	1SFA611201R2102	1	0.015
		Chrome metal	M2SS2-31G	1SFA611201R3102	1	0.024
	● Yellow	Black plastic	M2SS2-11Y	1SFA611201R1103	1	0.015
		Chrome plastic	M2SS2-21Y	1SFA611201R2103	1	0.015
		Chrome metal	M2SS2-31Y	1SFA611201R3103	1	0.024
	● Blue	Black plastic	M2SS2-11L	1SFA611201R1104	1	0.015
		Chrome plastic	M2SS2-21L	1SFA611201R2104	1	0.015
		Chrome metal	M2SS2-31L	1SFA611201R3104	1	0.024
○ Clear	Black plastic	M2SS2-11C	1SFA611201R1108	1	0.015	
	Chrome plastic	M2SS2-21C	1SFA611201R2108	1	0.015	
	Chrome metal	M2SS2-31C	1SFA611201R3108	1	0.024	
	● Red	Black plastic	M2SS3-11R	1SFA611202R1101	1	0.015
		Chrome plastic	M2SS3-21R	1SFA611202R2101	1	0.015
		Chrome metal	M2SS3-31R	1SFA611202R3101	1	0.024
	● Green	Black plastic	M2SS3-11G	1SFA611202R1102	1	0.015
		Chrome plastic	M2SS3-21G	1SFA611202R2102	1	0.015
		Chrome metal	M2SS3-31G	1SFA611202R3102	1	0.024
	● Yellow	Black plastic	M2SS3-11Y	1SFA611202R1103	1	0.015
		Chrome metal	M2SS3-31Y	1SFA611202R3103	1	0.024
		Chrome metal	M2SS3-31Y	1SFA611202R3103	1	0.024
	● Blue	Black plastic	M2SS3-11L	1SFA611202R1104	1	0.015
		Black plastic	M2SS3-11L	1SFA611202R1104	1	0.015
		Black plastic	M2SS3-11L	1SFA611202R1104	1	0.015
○ Clear	Black plastic	M2SS3-11C	1SFA611202R1108	1	0.015	
	Black plastic	M2SS3-11C	1SFA611202R1108	1	0.015	
	Chrome metal	M2SS3-31C	1SFA611202R3108	1	0.024	

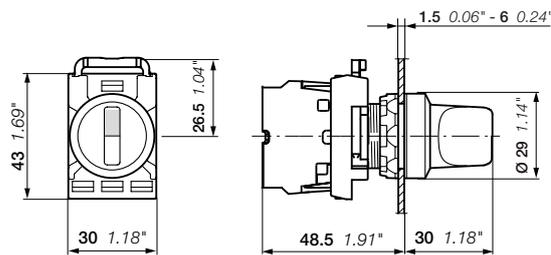

M2SS
Dimensions (mm, inches)

Modular plastic range

Illuminated selector switches - 2-position - Long handle



M2SS4-11R

1SFC151320V0001



M2SS4-31G

1SFC151322V0001

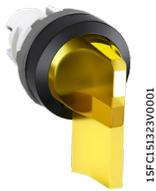

M2SS5-11Y

1SFC151323V0001

Contacts actuated

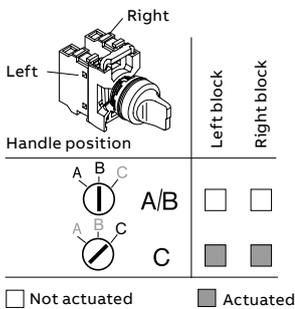

Operating principle	Color	Bezel	Type	Order code	Pkg qty	Weight (1 pce) kg
	● Red	Black plastic	M2SS4-11R	1SFA611203R1101	1	0.018
		Chrome plastic	M2SS4-21R	1SFA611203R2101	1	0.018
	● Green	Black plastic	M2SS4-11G	1SFA611203R1102	1	0.018
		Chrome plastic	M2SS4-21G	1SFA611203R2102	1	0.018
	● Yellow	Black plastic	M2SS4-11Y	1SFA611203R1103	1	0.018
		Chrome plastic	M2SS4-21Y	1SFA611203R2103	1	0.018
	● Blue	Black plastic	M2SS4-11L	1SFA611203R1104	1	0.018
		Chrome plastic	M2SS4-21L	1SFA611203R2104	1	0.018
	○ Clear	Black plastic	M2SS4-11C	1SFA611203R1108	1	0.018
		Chrome plastic	M2SS4-21C	1SFA611203R2108	1	0.018
		Chrome metal	M2SS4-31C	1SFA611203R3108	1	0.027
		● Red	Black plastic	M2SS5-11R	1SFA611204R1101	1
Chrome plastic			M2SS5-21R	1SFA611204R2101	1	0.018
Chrome metal			M2SS5-31R	1SFA611204R3101	1	0.027
● Green		Black plastic	M2SS5-11G	1SFA611204R1102	1	0.018
		Chrome plastic	M2SS5-21G	1SFA611204R2102	1	0.018
		Chrome metal	M2SS5-31G	1SFA611204R3102	1	0.027
● Yellow		Black plastic	M2SS5-11Y	1SFA611204R1103	1	0.018
		Chrome plastic	M2SS5-21Y	1SFA611204R2103	1	0.018
		Chrome metal	M2SS5-31Y	1SFA611204R3103	1	0.027
● Blue		Black plastic	M2SS5-11L	1SFA611204R1104	1	0.018
		Chrome plastic	M2SS5-21L	1SFA611204R2104	1	0.018
		Chrome metal	M2SS5-31L	1SFA611204R3104	1	0.027
○ Clear	Black plastic	M2SS5-11C	1SFA611204R1108	1	0.018	
	Chrome plastic	M2SS5-21C	1SFA611204R2108	1	0.018	
	Chrome metal	M2SS5-31C	1SFA611204R3108	1	0.027	
	● Red	Black plastic	M2SS6-11R	1SFA611205R1101	1	0.018
		Chrome plastic	M2SS6-21R	1SFA611205R2101	1	0.018
	● Green	Black plastic	M2SS6-11G	1SFA611205R1102	1	0.018
		Chrome plastic	M2SS6-21G	1SFA611205R2102	1	0.018
	● Yellow	Black plastic	M2SS6-11Y	1SFA611205R1103	1	0.018
		Chrome plastic	M2SS6-21Y	1SFA611205R2103	1	0.018
	● Blue	Black plastic	M2SS6-11L	1SFA611205R1104	1	0.018
		Chrome plastic	M2SS6-21L	1SFA611205R2104	1	0.018
	○ Clear	Black plastic	M2SS6-11C	1SFA611205R1108	1	0.018
		Chrome metal	M2SS6-31C	1SFA611205R3108	1	0.027

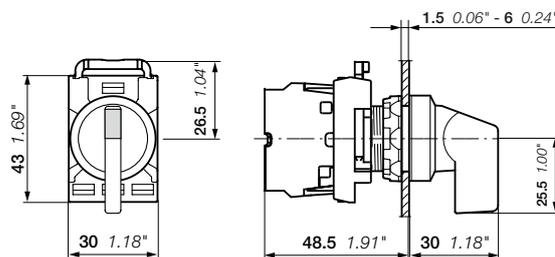

M2SS

Dimensions (mm, inches)

Modular plastic range

Illuminated selector switches - 3-position - Short handle



Contacts actuated

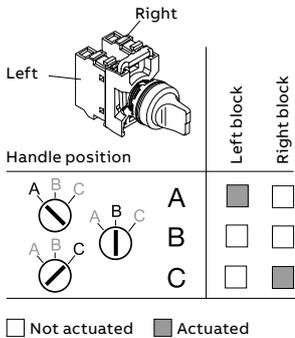

Operating principle	Color	Bezel	Type	Order code	Pkg qty	Weight (1 pce) kg
	● Red	Black plastic	M3SS1-11R	1SFA611210R1101	1	0.015
		Chrome plastic	M3SS1-21R	1SFA611210R2101	1	0.015
		Chrome metal	M3SS1-31R	1SFA611210R3101	1	0.024
	● Green	Black plastic	M3SS1-11G	1SFA611210R1102	1	0.015
		Chrome plastic	M3SS1-21G	1SFA611210R2102	1	0.015
		Chrome metal	M3SS1-31G	1SFA611210R3102	1	0.024
	● Yellow	Black plastic	M3SS1-11Y	1SFA611210R1103	1	0.015
		Chrome plastic	M3SS1-21Y	1SFA611210R2103	1	0.015
		Chrome metal	M3SS1-31Y	1SFA611210R3103	1	0.024
● Blue	Black plastic	M3SS1-11L	1SFA611210R1104	1	0.015	
	Chrome plastic	M3SS1-21L	1SFA611210R2104	1	0.015	
	Chrome metal	M3SS1-31L	1SFA611210R3104	1	0.024	
○ Clear	Black plastic	M3SS1-11C	1SFA611210R1108	1	0.015	
	Chrome plastic	M3SS1-21C	1SFA611210R2108	1	0.015	
	Chrome metal	M3SS1-31C	1SFA611210R3108	1	0.024	
	● Red	Black plastic	M3SS2-11R	1SFA611211R1101	1	0.015
		Chrome plastic	M3SS2-21R	1SFA611211R2101	1	0.015
		Chrome metal	M3SS2-31R	1SFA611211R3101	1	0.024
	● Green	Black plastic	M3SS2-11G	1SFA611211R1102	1	0.015
		Chrome plastic	M3SS2-21G	1SFA611211R2102	1	0.015
		Chrome metal	M3SS2-31G	1SFA611211R3102	1	0.024
	● Yellow	Black plastic	M3SS2-11Y	1SFA611211R1103	1	0.015
		Chrome plastic	M3SS2-21Y	1SFA611211R2103	1	0.015
		Chrome metal	M3SS2-31Y	1SFA611211R3104	1	0.024
● Blue	Black plastic	M3SS2-11L	1SFA611211R1104	1	0.015	
	Chrome plastic	M3SS2-21L	1SFA611211R2104	1	0.015	
	Chrome metal	M3SS2-31L	1SFA611211R3104	1	0.024	
○ Clear	Black plastic	M3SS2-11C	1SFA611211R1108	1	0.015	
	Chrome plastic	M3SS2-21C	1SFA611211R2108	1	0.015	
	Chrome metal	M3SS2-31C	1SFA611211R3108	1	0.024	
	● Red	Black plastic	M3SS3-11R	1SFA611212R1101	1	0.015
		Chrome plastic	M3SS3-21R	1SFA611212R2101	1	0.015
		Chrome metal	M3SS3-31R	1SFA611212R3101	1	0.024
	● Green	Black plastic	M3SS3-11G	1SFA611212R1102	1	0.015
		Chrome plastic	M3SS3-21G	1SFA611212R2102	1	0.015
		Chrome metal	M3SS3-31G	1SFA611212R3102	1	0.024
	● Yellow	Black plastic	M3SS3-11Y	1SFA611212R1103	1	0.015
		Chrome plastic	M3SS3-21Y	1SFA611212R2103	1	0.015
		Chrome metal	M3SS3-31Y	1SFA611212R3103	1	0.024
● Blue	Black plastic	M3SS3-11L	1SFA611212R1104	1	0.015	
	Chrome plastic	M3SS3-21L	1SFA611212R2104	1	0.015	
	Chrome metal	M3SS3-31L	1SFA611212R3104	1	0.024	
○ Clear	Black plastic	M3SS3-11C	1SFA611212R1108	1	0.015	
	Chrome plastic	M3SS3-21C	1SFA611212R2108	1	0.015	
	Chrome metal	M3SS3-31C	1SFA611212R3108	1	0.024	
	● Red	Black plastic	M3SS7-11R	1SFA611216R1101	1	0.015
		Chrome plastic	M3SS7-21G	1SFA611216R2102	1	0.015
		Chrome metal	M3SS7-31G	1SFA611216R3102	1	0.024
	● Yellow	Black plastic	M3SS7-11Y	1SFA611216R1103	1	0.015
		Chrome plastic	M3SS7-21L	1SFA611216R2104	1	0.015
		Chrome metal	M3SS7-31G	1SFA611216R3102	1	0.024
	● Blue	Black plastic	M3SS7-11L	1SFA611216R1104	1	0.015
		Chrome plastic	M3SS7-21L	1SFA611216R2104	1	0.015
		Chrome metal	M3SS7-31G	1SFA611216R3102	1	0.024
○ Clear	Black plastic	M3SS7-11C	1SFA611216R1108	1	0.015	
	Chrome plastic	M3SS7-21C	1SFA611216R2108	1	0.015	
	Chrome metal	M3SS7-31C	1SFA611216R3108	1	0.024	

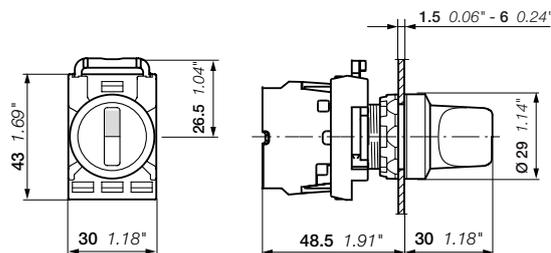

M3SS
Dimensions (mm, inches)

Modular plastic range

Illuminated selector switches - 3-position - Long handle



Contacts actuated

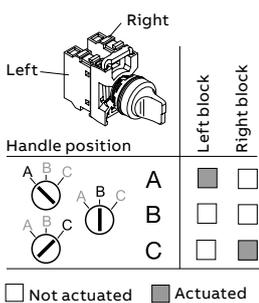

Operating principle	Color	Bezel	Type	Order code	Pkg qty	Weight (1 pce) kg
	● Red	Black plastic	M3SS4-11R	1SFA611213R1101	1	0.018
		Chrome plastic	M3SS4-21R	1SFA611213R2101	1	0.018
		Chrome metal	M3SS4-31R	1SFA611213R3101	1	0.027
	● Green	Black plastic	M3SS4-11G	1SFA611213R1102	1	0.018
		Chrome plastic	M3SS4-21G	1SFA611213R2102	1	0.018
	● Yellow	Black plastic	M3SS4-11Y	1SFA611213R1103	1	0.018
		Chrome plastic	M3SS4-21Y	1SFA611213R2103	1	0.018
	● Blue	Black plastic	M3SS4-11L	1SFA611213R1104	1	0.018
		Chrome plastic	M3SS4-21L	1SFA611213R2104	1	0.018
○ Clear	Black plastic	M3SS4-11C	1SFA611213R1108	1	0.018	
	Chrome plastic	M3SS4-21C	1SFA611213R2108	1	0.018	
	Chrome metal	M3SS4-31C	1SFA611213R3108	1	0.027	
	● Red	Black plastic	M3SS5-11R	1SFA611214R1101	1	0.018
		Chrome plastic	M3SS5-21R	1SFA611214R2101	1	0.018
		Chrome metal	M3SS5-31G	1SFA611214R3102	1	0.027
	● Green	Black plastic	M3SS5-11G	1SFA611214R1102	1	0.018
		Chrome plastic	M3SS5-21G	1SFA611214R2102	1	0.018
	● Yellow	Black plastic	M3SS5-11Y	1SFA611214R1103	1	0.018
		Chrome plastic	M3SS5-21Y	1SFA611214R2103	1	0.018
	● Blue	Black plastic	M3SS5-11L	1SFA611214R1104	1	0.018
		Chrome plastic	M3SS5-21L	1SFA611214R2104	1	0.018
○ Clear	Black plastic	M3SS5-11C	1SFA611214R1108	1	0.018	
	Chrome plastic	M3SS5-21C	1SFA611214R2108	1	0.018	
	Chrome metal	M3SS5-31C	1SFA611214R3108	1	0.027	
	● Red	Black plastic	M3SS6-11R	1SFA611215R1101	1	0.018
		Chrome plastic	M3SS6-21G	1SFA611215R2102	1	0.018
		Chrome metal	M3SS6-31G	1SFA611215R3102	1	0.027
	● Green	Black plastic	M3SS6-11G	1SFA611215R1102	1	0.018
		Chrome plastic	M3SS6-21G	1SFA611215R2102	1	0.018
	● Yellow	Black plastic	M3SS6-11Y	1SFA611215R1103	1	0.018
		Chrome plastic	M3SS6-21Y	1SFA611215R2103	1	0.018
	● Blue	Black plastic	M3SS6-11L	1SFA611215R1104	1	0.018
		Chrome metal	M3SS6-31L	1SFA611215R3104	1	0.027
○ Clear	Black plastic	M3SS6-11C	1SFA611215R1108	1	0.018	
	● Red	Black plastic	M3SS8-11R	1SFA611217R1101	1	0.018
		Chrome plastic	M3SS8-21R	1SFA611217R2101	1	0.018
Chrome metal		M3SS8-31R	1SFA611217R3101	1	0.027	
● Green	Black plastic	M3SS8-11G	1SFA611217R1102	1	0.018	
	Chrome plastic	M3SS8-21G	1SFA611217R2102	1	0.018	
● Yellow	Black plastic	M3SS8-11Y	1SFA611217R1103	1	0.018	
	Chrome metal	M3SS8-31G	1SFA611217R3102	1	0.027	
● Blue	Black plastic	M3SS8-11L	1SFA611217R1104	1	0.018	
	Black plastic	M3SS8-11C	1SFA611217R1108	1	0.018	

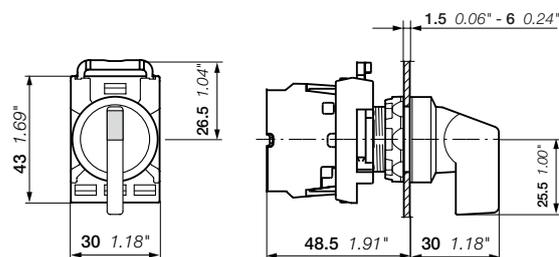

M3SS
Dimensions (mm, inches)

Modular plastic range

Key-operated selector switches - 2-position



M2SSK1-101

Description

Key-operated selector switches are delivered in black color.

Operating principle	Key	Bezel	Type	Order code	Pkg qty	Weight (1 pce) kg	
 Key can be removed in both positions	Key code 455	Black plastic	M2SSK1-101	1SFA611280R1001	1	0.045	
		Chrome plastic	M2SSK1-201	1SFA611280R2001	1	0.045	
		Chrome metal	M2SSK1-301	1SFA611280R3001	1	0.054	
	Key code 421	Black plastic	M2SSK1-102	1SFA611280R1002	1	0.045	
		Chrome metal	M2SSK1-302	1SFA611280R3002	1	0.054	
		Key code 3433-E	Black plastic	M2SSK1-103	1SFA611280R1003	1	0.045
	Random selection (1)	Black plastic	M2SSK1-104	1SFA611280R1004	25	0.045	
		Chrome metal	M2SSK1-304	1SFA611280R3004	25	0.054	
	 Key can be removed in B position only	Key code 455	Black plastic	M2SSK2-101	1SFA611281R1001	1	0.045
			Chrome plastic	M2SSK2-201	1SFA611281R2001	1	0.045
Chrome metal			M2SSK2-301	1SFA611281R3001	1	0.054	
Key code 421		Black plastic	M2SSK2-102	1SFA611281R1002	1	0.045	
		Chrome metal	M2SSK2-302	1SFA611281R3002	1	0.054	
		Key code 3433-E	Black plastic	M2SSK2-103	1SFA611281R1003	1	0.045
Random selection (1)		Chrome plastic	M2SSK2-203	1SFA611281R2003	1	0.045	
		Chrome metal	M2SSK2-303	1SFA611281R3003	1	0.054	
Random selection (1)		Black plastic	M2SSK2-104	1SFA611281R1004	25	0.045	
		Chrome metal	M2SSK2-304	1SFA611281R3004	25	0.054	
 Key can be removed in position B only	Key code 455	Black plastic	M2SSK3-101	1SFA611282R1001	1	0.045	
		Chrome metal	M2SSK3-301	1SFA611282R3001	1	0.054	
	Key code 421	Black plastic	M2SSK3-102	1SFA611282R1002	1	0.045	
		Chrome metal	M2SSK3-302	1SFA611282R3002	1	0.054	
	Key code 3433-E	Black plastic	M2SSK3-103	1SFA611282R1003	1	0.045	
		Chrome metal	M2SSK3-303	1SFA611282R3003	1	0.054	
	Random selection (1)	Black plastic	M2SSK3-104	1SFA611282R1004	25	0.045	
		Chrome metal	M2SSK3-304	1SFA611282R3004	25	0.054	
	Key code 455	Black plastic	M2SSK4-101	1SFA611289R1001	1	0.045	
		Chrome metal	M2SSK4-301	1SFA611289R3001	1	0.054	

Contacts actuated

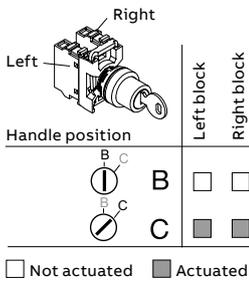

(1) The order code includes 25 keys operated selector switches. Each selector switch includes unique key code. Key codes 455, 421 and 3433-E not included.

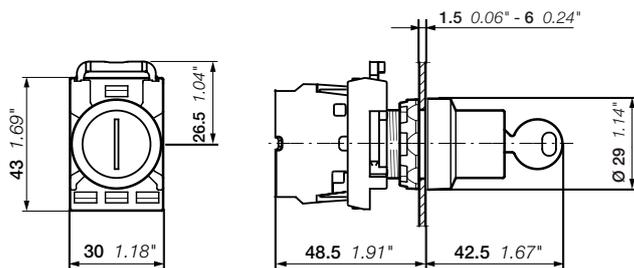

M2SSK
Dimensions (mm, inches)

Modular plastic range

Key-operated selector switches - 3-position



Description

Key-operated selector switches are delivered in black color.

Operating principle	key	Bezel	Type	Order code	Pkg qty (1 pce)	Weight kg
 Key can be removed in all positions	Key code 455	Black plastic	M3SSK1-101	1SFA611283R1001	1	0.045
		Chrome plastic	M3SSK1-201	1SFA611283R2001	1	0.045
	Key code 421	Black plastic	M3SSK1-102	1SFA611283R1002	1	0.045
		Chrome metal	M3SSK1-302	1SFA611283R3002	1	0.054
	Key code 3433-E	Black plastic	M3SSK1-103	1SFA611283R1003	1	0.045
		Chrome metal	M3SSK1-303	1SFA611283R3003	1	0.054
Random selection (1)	Black plastic	M3SSK1-104	1SFA611283R1004	25	0.045	
	Chrome metal	M3SSK1-304	1SFA611283R3004	25	0.054	
 Key can be removed in position B only	Key code 455	Black plastic	M3SSK2-101	1SFA611284R1001	1	0.045
		Chrome metal	M3SSK2-301	1SFA611284R3001	1	0.054
	Key code 421	Black plastic	M3SSK2-102	1SFA611284R1002	1	0.045
		Chrome metal	M3SSK2-302	1SFA611284R3002	1	0.054
Key code 3433-E	Black plastic	M3SSK2-103	1SFA611284R1003	1	0.045	
	Chrome metal	M3SSK2-303	1SFA611284R3003	1	0.054	
Random selection (1)	Black plastic	M3SSK2-104	1SFA611284R1004	25	0.045	
	Chrome metal	M3SSK2-304	1SFA611284R3004	25	0.054	
 Key can be removed in position B only	Key code 455	Black plastic	M3SSK3-101	1SFA611285R1001	1	0.045
		Chrome metal	M3SSK3-301	1SFA611285R3001	1	0.054
	Key code 421	Black plastic	M3SSK3-102	1SFA611285R1002	1	0.045
		Chrome metal	M3SSK3-302	1SFA611285R3002	1	0.054
Key code 3433-E	Black plastic	M3SSK3-103	1SFA611285R1003	1	0.045	
	Chrome metal	M3SSK3-303	1SFA611285R3003	1	0.054	
Random selection (1)	Black plastic	M3SSK3-104	1SFA611285R1004	25	0.045	
	Chrome metal	M3SSK3-304	1SFA611285R3004	25	0.054	
 Key can be removed in position A only	Key code 455	Black plastic	M3SSK4-101	1SFA611286R1001	1	0.045
		Chrome metal	M3SSK4-301	1SFA611286R3001	1	0.054
	Key code 421	Black plastic	M3SSK4-102	1SFA611286R1002	1	0.045
		Chrome metal	M3SSK4-302	1SFA611286R3002	1	0.054
Key code 3433-E	Black plastic	M3SSK4-103	1SFA611286R1003	1	0.045	
	Chrome metal	M3SSK4-303	1SFA611286R3003	1	0.054	
Random selection (1)	Black plastic	M3SSK4-104	1SFA611286R1004	25	0.045	
	Chrome metal	M3SSK4-304	1SFA611286R3004	25	0.054	
 Key can be removed in all positions	Key code 455	Black plastic	M3SSK5-101	1SFA611287R1001	1	0.045
		Chrome metal	M3SSK5-301	1SFA611287R3001	1	0.054
	Key code 3433-E	Black plastic	M3SSK5-103	1SFA611287R1003	1	0.045
 Key can be removed in A only	Key code 455	Black plastic	M3SSK6-101	1SFA611288R1001	1	0.045
		Chrome metal	M3SSK6-301	1SFA611288R3001	1	0.054

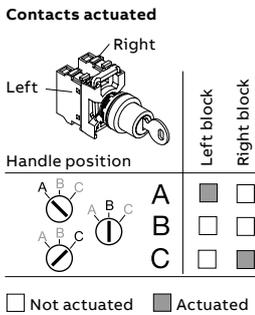

(1) The order code includes 25 key operated selector switches. Each selector switch includes unique key code. Key codes 455, 421 and 3433-E not included.

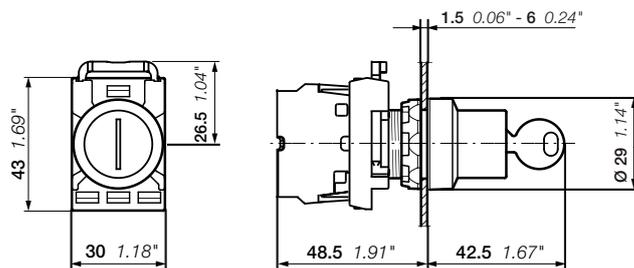

M3SSK
Dimensions (mm, inches)

Modular plastic range

Potentiometers



MT-110B

1SFC151B55W0001

Description

Black knob with integrated position indication and marking in white.

Bezel	Type	Order code	Pkg qty	Weight (1 pce) kg	
Knob with resistor 5 kΩ					
Black plastic	MT-105B	1SFA611410R1056	1	0.040	
Chrome plastic	MT-205B	1SFA611410R2056	1	0.040	
Chrome metal	MT-305B	1SFA611410R3056	1	0.049	
Knob with resistor 10 kΩ					
Black plastic	MT-110B	1SFA611410R1106	1	0.040	
Chrome plastic	MT-210B	1SFA611410R2106	1	0.040	
Chrome metal	MT-310B	1SFA611410R3106	1	0.048	
Knob with resistor 50 kΩ					
Black plastic	MT-150B	1SFA611410R1506	1	0.040	
Chrome plastic	MT-250B	1SFA611410R2506	1	0.040	
Chrome metal	MT-350B	1SFA611410R3506	1	0.049	
Knob without resistor (1)					
Black plastic	MT-1B	1SFA611410R1006	10	0.022	
Chrome metal	MT-3B	1SFA611410R3006	10	0.030	
Legend plates aluminum					
29.6 x 44.5 mm	Ø 22 mm	–	SK615562-87	10	0.002
48.5 x 44.5 mm, scale: 0-10	Ø 22 mm	–	SK615562-88	10	0.002
48.5 x 44.5 mm, scale: 0-50	Ø 22 mm	MA6-1252	1SFA611930R1252	10	0.002

(1) Knob without resistor: for shaft diameter 6-6.35 mm. Min. shaft length 20 mm.



MA6-1252

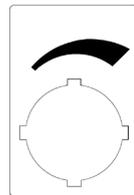

SK615562-87

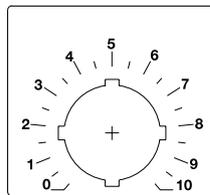

SK615562-88

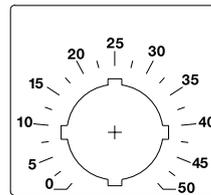

MA6-1252

Technical data

Power rating	2 W
Mechanical angle	280°
Insulation voltage	900 V
Operating temperature	-1 ... + 70° C
Resistance tolerance	± 10 ohm
Mechanical life	20 000 operations

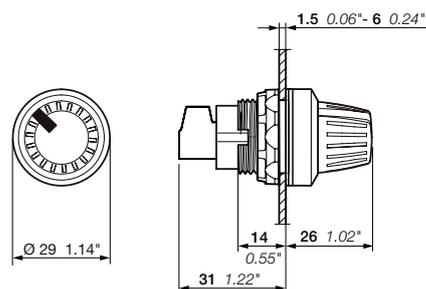

MT

Dimensions (mm, inches)

Modular plastic range

Reset pushbuttons



KPR1-100G



KPR1-101L



KPR1-104B

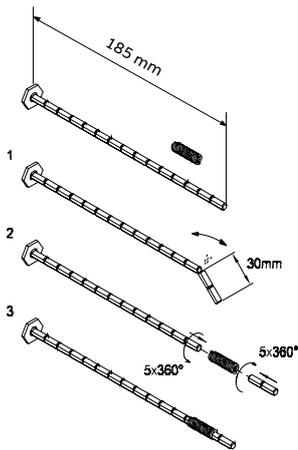

KA1-8046



KA1-8047

Description

Reset pushbuttons are momentary and include only black plastic bezel.

Color	Text	Type	Order code	Pkg qty	Weight (1 pce) kg
Flush reset pushbutton					
● Red	No text	KPR1-100R	1SFA616160R1001	10	0.020
● Green	No text	KPR1-100G	1SFA616160R1002	10	0.020
	I	KPR1-102G	1SFA616160R1022	10	0.020
	II	KPR1-103G	1SFA616160R1032	10	0.020
● Yellow	No text	KPR1-100Y	1SFA616160R1003	10	0.020
	I	KPR1-102Y	1SFA616160R1023	10	0.020
	II	KPR1-103Y	1SFA616160R1033	10	0.020
● Blue	No text	KPR1-100L	1SFA616160R1004	10	0.020
	R	KPR1-101L	1SFA616160R1014	10	0.020
	I	KPR1-102L	1SFA616160R1024	10	0.020
○ White	No text	KPR1-100W	1SFA616160R1005	10	0.020
	R	KPR1-101W	1SFA616160R1015	10	0.020
	I	KPR1-102W	1SFA616160R1025	10	0.020
● Black	No text	KPR1-100B	1SFA616160R1006	10	0.020
	R	KPR1-101B	1SFA616160R1016	10	0.020
	RESET	KPR1-104B	1SFA616160R1046	10	0.020

Extended reset pushbutton

● Red	No text	KPR2-100R	1SFA616161R1001	10	0.021
	O	KPR2-105R	1SFA616161R1051	10	0.021
● Black	No text	KPR2-100B	1SFA616161R1006	10	0.021

Accessories

	Type	Order code	Pkg qty	Weight (1 pce) kg
Shaft	KA1-8046	1SFA616920R8046	10	0.007
Flexible joint	KA1-8047	1SFA616920R8047	10	0.005

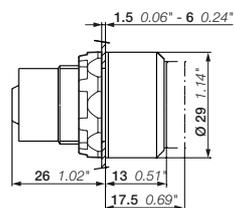

KPR1, KPR2

Dimensions (mm, inches)

Modular plastic range

Reset pushbuttons with shaft

02



KPR3-100R

15FC15125V0001



KPR3-104B

15FC15122V0001

Description

Reset pushbuttons are momentary and include only black plastic bezel.

Color	Text	Type	Order code	Pkg qty	Weight (1 pce) kg
Flush reset pushbutton					
● Red	No text	KPR3-100R	1SFA616162R1001	1	0.027
● Green	No text	KPR3-100G	1SFA616162R1002	1	0.027
	II	KPR3-103G	1SFA616162R1032	1	0.027
● Yellow	No text	KPR3-100Y	1SFA616162R1003	1	0.027
● Blue	No text	KPR3-100L	1SFA616162R1004	1	0.027
	R	KPR3-101L	1SFA616162R1014	1	0.027
○ White	No text	KPR3-100W	1SFA616162R1005	1	0.027
	R	KPR3-101W	1SFA616162R1015	1	0.027
● Black	No text	KPR3-100B	1SFA616162R1006	1	0.027
	RESET	KPR3-104B	1SFA616162R1046	1	0.027
Extended reset pushbutton					
● Red	No text	KPR4-100R	1SFA616163R1001	1	0.028
	O	KPR4-105R	1SFA616163R1051	1	0.028
● Black	No text	KPR4-100B	1SFA616163R1006	1	0.028
	O	KPR4-105B	1SFA616163R1056	1	0.028

Note: Flexible joint not included.

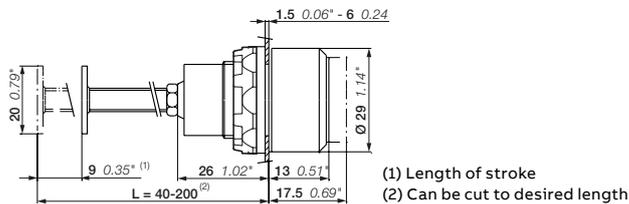

KPR3, KPR4

Dimensions (mm, inches)

Modular plastic range

Joysticks



MJS1-60B

Contacts actuated

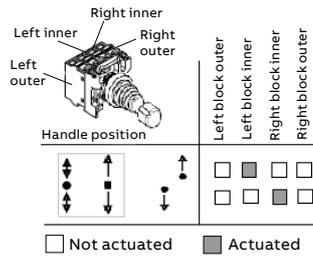

Contacts actuated

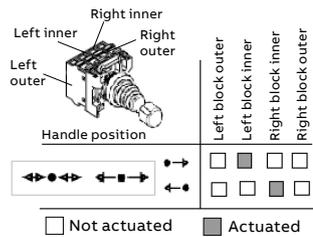

Contacts actuated

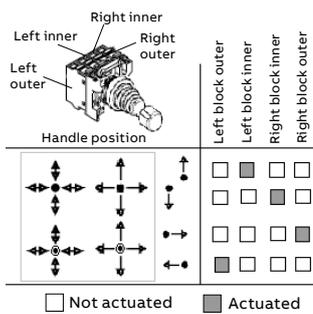

MA1-8138



MA1-8137

Description

IP protection degree : IP66, IP67 and IP69K. 4-position holder included.

Position	Bezel	Type	Order code	Pkg qty	Weight (1 pce) kg
↑ ↓	Black plastic	MJS1-40B	1SFA611701R4006	1	0.043
	Chrome metal	MJS1-60B	1SFA611701R6006	1	0.052
↑ ↓ ↔	Black plastic	MJS2-40B	1SFA611702R4006	1	0.043
	Chrome metal	MJS2-60B	1SFA611702R6006	1	0.052
↔	Black plastic	MJS3-40B	1SFA611703R4006	1	0.043
	Chrome metal	MJS3-60B	1SFA611703R6006	1	0.052
↔ ↕	Black plastic	MJS4-40B	1SFA611704R4006	1	0.043
	Chrome metal	MJS4-60B	1SFA611704R6006	1	0.052
↕	Black plastic	MJS5-40B	1SFA611705R4006	1	0.043
	Chrome metal	MJS5-60B	1SFA611705R6006	1	0.052
↕ ↔	Black plastic	MJS6-40B	1SFA611706R4006	1	0.043
	Chrome metal	MJS6-60B	1SFA611706R6006	1	0.052

With latching function

↑ ↓	Black plastic	MJS7-40B	1SFA611707R4006	1	0.043
	Chrome metal	MJS7-60B	1SFA611707R6006	1	0.052
↑ ↓ ↔	Black plastic	MJS9-40B	1SFA611709R4006	1	0.043
	Chrome metal	MJS9-60B	1SFA611709R6006	1	0.052
↔	Black plastic	MJS8-40B	1SFA611708R4006	1	0.043
	Chrome metal	MJS8-60B	1SFA611708R6006	1	0.052
↔ ↕	Black plastic	MJS10-60B	1SFA611710R6006	1	0.052
	Chrome metal	MJS10-40B	1SFA611711R4006	1	0.043
↕	Black plastic	MJS11-40B	1SFA611711R4006	1	0.043
	Chrome metal	MJS11-60B	1SFA611711R6006	1	0.052
↕ ↔	Black plastic	MJS12-40B	1SFA611712R4006	1	0.043
	Chrome metal	MJS12-60B	1SFA611712R6006	1	0.052

Accessories

Type	Order code	Pkg qty	Weight (1 pce) kg
Legend plates, 66 x 59 aluminum laminate with adhesive back			
2-position - Up - Down	MA6-1240 1SFA611930R1240	10	0.004
2-position - Left - Right	MA6-1241 1SFA611930R1241	10	0.004
4-position Up - down - right - left	MA6-1242 1SFA611930R1242	10	0.004

Legend plates holder (inserts not included, suitable for insert size 27x15)

2-position	MA1-8138 1SFA611920R8138	10	0.002
4-position	MA1-8137 1SFA611920R8137	10	0.003

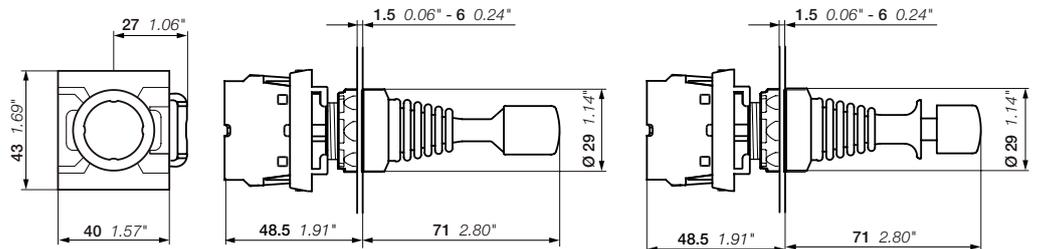

MJS
Dimensions (mm, inches)

Modular plastic range

Toggle switches



MTS1-10B

1SFC15132V0001



MTS1-30B

1SFC151346V0001

Operating principle	Bezel	Type	Order code	Pkg qty	Weight (1 pce) kg
2-position					
	Black plastic	MTS1-10B	1SFA611300R1006	10	0.014
	Chrome plastic	MTS1-20B	1SFA611300R2006	10	0.014
	Chrome metal	MTS1-30B	1SFA611300R3006	10	0.023
3-position					
	Black plastic	MTS3-10B	1SFA611302R1006	10	0.014
	Chrome plastic	MTS3-20B	1SFA611302R2006	10	0.014
	Chrome metal	MTS3-30B	1SFA611302R3006	10	0.023
	Black plastic	MTS2-10B	1SFA611301R1006	10	0.014
	Chrome plastic	MTS2-20B	1SFA611301R2006	10	0.014
	Chrome metal	MTS2-30B	1SFA611301R3006	10	0.023

Contacts actuated, 2-position

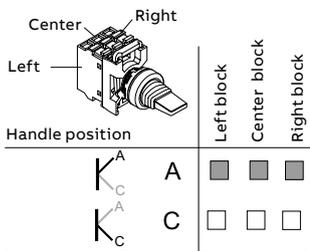

□ Not actuated ■ Actuated

Contacts actuated, 3-position

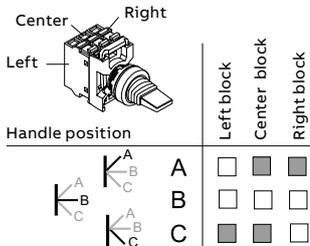

□ Not actuated ■ Actuated

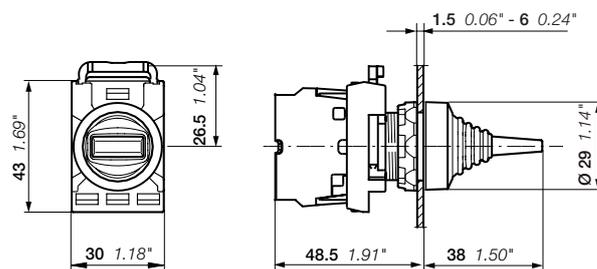

MTS
Dimensions (mm, inches)

Modular plastic range

Contact block configuration

Pushbuttons - Heavy duty pushbuttons (1) - Mushrooms pushbuttons



Double pushbuttons



Selector switches



Emergency stop pushbuttons - Machine stop pushbuttons

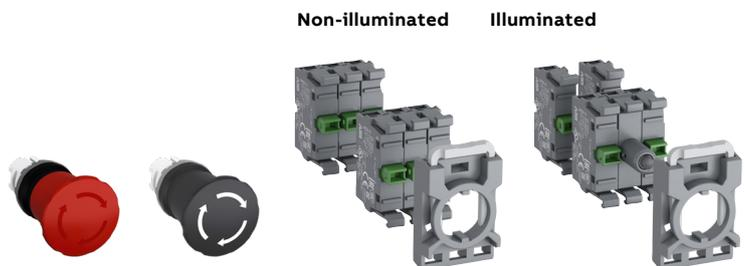

Toggle switches - Center block operating selector switches



Pilot lights

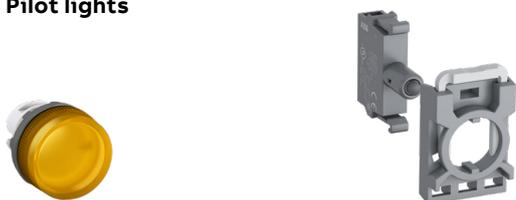

Joysticks (2)

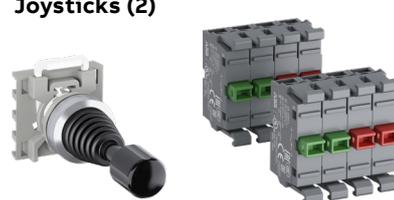

Note: locking nut included with all operators.

(2) Holder is included for joystick.

Modular plastic range

Holders and contact blocks for front mounting



MCBH-00



MCBH5-00



MCB-10



MCB-02



MCBL-01

Description	Contacts	Type	Order code	Pkg qty	Weight (1 pce)
kg					
Holders					
3-position	--	MCBH-00	1SFA611605R1100	10	0.006
5-position	--	MCBH5-00	1SFA611601R1100	10	0.008
Single contact blocks					
For 3 & 5-position holder	10	MCB-10	1SFA611610R1001	10	0.013
	01	MCB-01	1SFA611610R1010	10	0.013
Single contact blocks, gold plated contacts					
For 3 & 5-position holder	10	MCB-10G	1SFA611610R1101	10	0.013
	01	MCB-01G	1SFA611610R1110	10	0.013
Double contact blocks					
For 3 & 5-position holder	20	MCB-20	1SFA611610R1002	10	0.026
	02	MCB-02	1SFA611610R1020	10	0.026
	11	MCB-11	1SFA611610R1011	10	0.026
Double contact blocks, gold plated contacts					
For 3 & 5-position holder	20	MCB-20G	1SFA611610R1102	10	0.026
	02	MCB-02G	1SFA611610R1120	10	0.026
	11	MCB-11G	1SFA611610R1111	10	0.026
Micro switch contact blocks					
For 3-position holder	10	MCBL-10	1SFA611612R1010	10	0.013
	01	MCBL-01	1SFA611612R1001	10	0.013

Note: 3 micro switch contact blocks max. allowed. If more than 3 contact blocks are needed, micro switch contact block to be mounted on the second stack.

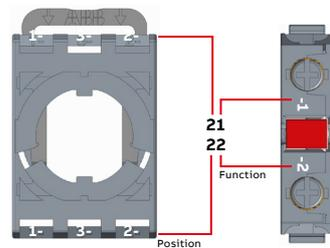

Combined markings

11	31	21
12	32	22

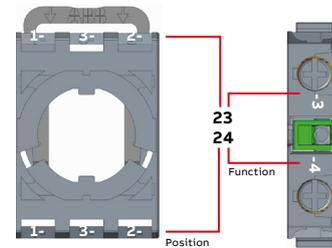

Combined markings

13	33	23
14	34	24

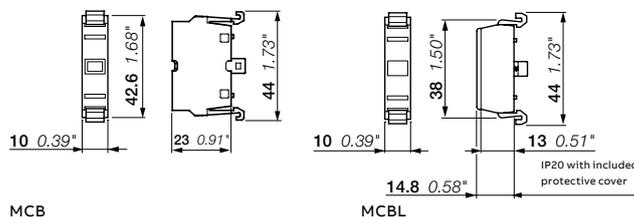
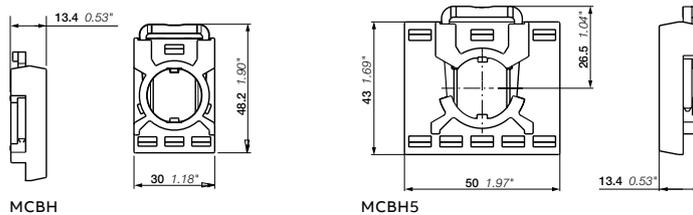

Dimensions (mm, inches)

Modular plastic range

LED blocks for front mounting



MLBL-00W

1SFC151417V0001

Color	Rated current mA	Wavelength nm	Luminance mcd	Type	Order code	Pkg qty	Weight (1pce) kg
Rated voltage 12 V DC							
● Red	12.0	620	320	MLBL-00R	1SFA611621R1001	10	0.012
● Green	12.0	520	1500	MLBL-00G	1SFA611621R1002	10	0.012
● Yellow	12.0	588	380	MLBL-00Y	1SFA611621R1003	10	0.012
● Blue	12.0	468	450	MLBL-00L	1SFA611621R1004	10	0.012
○ White	12.0	(1)	600	MLBL-00W	1SFA611621R1005	10	0.012
Rated voltage 24 V AC/DC							
● Red	10.0	620	250	MLBL-01R	1SFA611621R1011	10	0.012
● Green	10.0	520	1500	MLBL-01G	1SFA611621R1012	10	0.012
● Yellow	10.0	588	250	MLBL-01Y	1SFA611621R1013	10	0.012
● Blue	10.0	468	450	MLBL-01L	1SFA611621R1014	10	0.012
○ White	10.0	(1)	600	MLBL-01W	1SFA611621R1015	10	0.012
Rated voltage 48 V AC/DC							
● Red	10.0	620	260	MLBL-02R	1SFA611621R1021	10	0.012
● Green	13.0	520	1500	MLBL-02G	1SFA611621R1022	10	0.012
● Yellow	10.0	588	300	MLBL-02Y	1SFA611621R1023	10	0.012
● Blue	13.0	468	450	MLBL-02L	1SFA611621R1024	10	0.012
○ White	13.0	(1)	600	MLBL-02W	1SFA611621R1025	10	0.012
Rated voltage 60 V AC/DC							
● Red	13.0	620	350	MLBL-03R	1SFA611621R1031	10	0.012
● Green	13.0	520	2000	MLBL-03G	1SFA611621R1032	10	0.012
● Yellow	13.0	588	400	MLBL-03Y	1SFA611621R1033	10	0.012
● Blue	13.0	468	550	MLBL-03L	1SFA611621R1034	10	0.012
○ White	13.0	(1)	750	MLBL-03W	1SFA611621R1035	10	0.012
Rated voltage 110-130 V AC							
● Red	10.0	620	200	MLBL-04R	1SFA611621R1041	10	0.012
● Green	10.0	520	1200	MLBL-04G	1SFA611621R1042	10	0.012
● Yellow	10.0	588	250	MLBL-04Y	1SFA611621R1043	10	0.012
● Blue	10.0	468	400	MLBL-04L	1SFA611621R1044	10	0.012
○ White	10.0	(1)	500	MLBL-04W	1SFA611621R1045	10	0.012
Rated voltage 110-130 V AC high anti-inductive voltage (2)							
● Red	10.0	620	250	MLBL-04AR	1SFA611621R3041	10	0.012
● Green	10.0	520	1500	MLBL-04AG	1SFA611621R3042	10	0.012
● Yellow	10.0	582	300	MLBL-04AY	1SFA611621R3043	10	0.012
● Blue	10.0	468	450	MLBL-04AL	1SFA611621R3044	10	0.012
○ White	10.0	(1)	600	MLBL-04AW	1SFA611621R3045	10	0.012
Rated voltage 110-130 V DC							
● Red	10.0	620	250	MLBL-05R	1SFA611621R1051	10	0.012
● Green	10.0	520	1500	MLBL-05G	1SFA611621R1052	10	0.012
● Yellow	10.0	588	300	MLBL-05Y	1SFA611621R1053	10	0.012
● Blue	10.0	468	450	MLBL-05L	1SFA611621R1054	10	0.012
○ White	10.0	(1)	600	MLBL-05W	1SFA611621R1055	10	0.012
Rated voltage 220 V DC							
● Red	8.0	620	180	MLBL-06R	1SFA611621R1061	10	0.012
● Green	8.0	520	110	MLBL-06G	1SFA611621R1062	10	0.012
● Yellow	8.0	588	200	MLBL-06Y	1SFA611621R1063	10	0.012
● Blue	8.0	468	450	MLBL-06L	1SFA611621R1064	10	0.012
○ White	8.0	(1)	600	MLBL-06W	1SFA611621R1065	10	0.012

Note: care should be taken for DC supply where + and - must be correctly connected. This is marked X1 (+) and X2 (-) on the product.

(1) X=0.31, Y=0.32 according to the ICI Chromaticity diagram.

(2) Higher threshold to light up LED to be used in application where there is risk of large induced voltages.

Modular plastic range

LED blocks for front mounting



MLBL-00W

1SFC15141V0001

Color	Rated current mA	Wavelength nm	Luminance mcd	Type	Order code	Pkg qty	Weight (1pce) kg
Rated voltage 230 V AC							
● Red	10.0	620	250	MLBL-07R	1SFA611621R1071	10	0.012
● Green	10.0	520	1500	MLBL-07G	1SFA611621R1072	10	0.012
● Yellow	10.0	588	300	MLBL-07Y	1SFA611621R1073	10	0.012
● Blue	10.0	468	450	MLBL-07L	1SFA611621R1074	10	0.012
○ White	10.0	(1)	600	MLBL-07W	1SFA611621R1075	10	0.012
Rated voltage 230 V AC high anti-inductive voltage (2)							
● Red	10.0	620	250	MLBL-99R	1SFA611621R1991	10	0.012
● Green	10.0	520	1500	MLBL-99G	1SFA611621R1992	10	0.012
● Yellow	10.0	588	300	MLBL-99Y	1SFA611621R1993	10	0.012
● Blue	10.0	468	450	MLBL-99L	1SFA611621R1994	10	0.012
○ White	10.0	(1)	600	MLBL-99W	1SFA611621R1995	10	0.012
Rated voltage 380 V AC							
● Red	10.0	620	250	MLBL-08R	1SFA611621R1081	10	0.012
● Green	10.0	520	1500	MLBL-08G	1SFA611621R1082	10	0.012
● Yellow	10.0	582	300	MLBL-08Y	1SFA611621R1083	10	0.012
● Blue	10.0	468	450	MLBL-08L	1SFA611621R1084	10	0.012
○ White	10.0	(1)	600	MLBL-08W	1SFA611621R1085	10	0.012
Rated voltage 415 V AC							
● Red	11	620	280	MLBL-09R	1SFA611621R1091	10	0.012
● Green	11	520	1800	MLBL-09G	1SFA611621R1092	10	0.012
● Yellow	11	588	350	MLBL-09Y	1SFA611621R1093	10	0.012
● Blue	11	468	500	MLBL-09L	1SFA611621R1094	10	0.012
○ White	11	(1)	650	MLBL-09W	1SFA611621R1095	10	0.012

Note: care should be taken for DC supply where + and - must be correctly connected. This is marked X1 (+) and X2 (-) on the product.

(1) X=0.31, Y=0.32 according to the ICI Chromaticity diagram.

(2) Higher threshold to light up LED to be used in application where there is risk of large induced voltages.

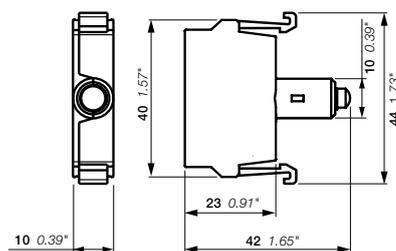

MLBL

Dimensions (mm, inches)

Modular plastic range

Accessories



Description	Bezel / color	Type	Order code	Pkg qty	Weight (1pce) kg
30 mm adaptors for 22 mm operator (1.5 - 4 mm panel thickness)					
Emergency stop pushbuttons, MPM	Black plastic	KA1-8027	1SFA616920R8027	1	0.007
	Chrome metal	KA1-8028	1SFA616920R8028	1	0.021
Pushbuttons, selector switches, pilot lights, potentiometers, emergency stop pushbuttons, MPE, MJS	Black plastic	KA1-8029	1SFA616920R8029	1	0.010
Flush mounted pushbuttons	Chrome metal	KA1-8073	1SFA616920R8073	1	0.050
Flush mounted selector switches	Chrome metal	MA1-8074	1SFA611920R8074	1	0.050
Protective membrane, silicone					
Flush pushbutton		MA1-8052	1SFA611920R8052	10	0.002
Double pushbutton		MA1-8126	1SFA611920R8126	10	0.002
Extended pushbutton		MA1-8002	1SFA611920R8002	10	0.002
Protective ring					
To prevent accidental operation. Cannot be used together with Legend plate holder					
Flush and extended pushbuttons	Clear plastic	-	SK615512-1	10	0.002
Flush pushbuttons	Metal and black plastic	KA1-8010	1SFA616920R8010	10	0.008
Bezel					
Pushbuttons	Black plastic	KA1-8022	1SFA616920R8022	10	0.002
	Chrome plastic	KA1-8020	1SFA616920R8020	10	0.002
	Chrome metal	KA1-8021	1SFA616920R8021	10	0.015
Selector switches	Black plastic	KA1-8080	1SFA616920R8080	10	0.002
	Chrome metal	KA1-8024	1SFA616920R8024	10	0.015
Square bezel					
Black plastic		-	SK616016-2	10	0.001
Lockable shroud					
Pushbuttons, selector switches	Plastic	MA1-8153	1SFA611920R8153	1	0.023
Emergency stop 30 mm	Metal	-	SK615502-D	1	0.080
Touch guard					
Touch guard		MA1-8152	1SFA611920R8152	1	0.023
Shroud with anti rotation tabs, slot for pad-lock and with water drainage					
Emergency stop, machine stop 40 mm	● Yellow	MA1-8053	1SFA611920R8053	1	0.020
	● Grey	MA1-8128	1SFA611920R8128	1	0.020

Note: Din-rail adaptor should be used with 2 contact blocks for rear mounting type MCB..B.

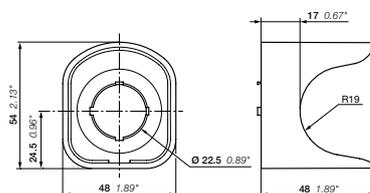

MA1
Dimensions (mm, inches)

Modular plastic range

Accessories



MA1-8131

1SFC151276V0001



MDB-2

1SFC151455F0001



MA1-8015

1SFC151275V0001



MA1-8149

1SFC151004F0001



MA1-8019

1SFC151385V0001

Description	Bezel / color	Type	Order code	Pkg qty	Weight (1pce) kg
DIN-rail adaptor					
DIN-rail adaptor		MA1-8131	1SFA611920R8131	1	0.020
DIN-rail adaptor with one dummy block		MA1-8001	1SFA611920R8001	1	0.028
Dummy block		MDB-2	1SFA611630R1002	10	0.003
Note: Din-rail adaptor should be used with 2 contact blocks for rear mounting type MCB..B.					
Note: Dummy blocks are used when only one contact block or a compact pilot device is used together with the DIN-rail adaptor					
Mounting tools					
Mounting tool for tightening the locking nut		MA1-8015	1SFA611920R8015	1	0.021
Mounting tool for power tool		MA1-8149	1SFA611920R8149	1	0.155
Extra key					
Key code 455			SK616021-71	10	0.007
Key code 421			SK616021-72	10	0.007
Key code 3433-E			SK616021-73	10	0.007
Locking nut					
Locking nut		MA1-8019	1SFA611920R8019	10	0.001

Modular plastic range

Technical data

Standards and approvals

IEC / EN 60947-1	Low Voltage switchgear and controlgear - Part 1: General rules
IEC / EN 60947-5-1	Low Voltage switchgear and controlgear - part 5-1: control circuit devices and switching elements - Electromechanical control circuit devices
IEC / EN 60947-5-5	Low Voltage switchgear and controlgear - part 5-5: control circuit devices and switching elements - Electrical emergency stop device with mechanical latching function
IEC / EN 60073	Basic and safety principles for man-machine interface, marking and identification coding principles for indicators and actuators
IEC / EN 60529	Degrees of protection provided by enclosures (IP code)
EN 50013	Low Voltage switchgear and controlgear for industrial use, terminal marking and distinctive number for particular control switches
DIN 40050-9	Road vehicles; Degrees of protection (IP-code); protection against foreign objects; water and contact; electrical equipment
UL 508	Industrial control equipment
CSA C22.2 No 14	Industrial control equipment

Environmental data

Degrees of protection

Operators	IEC/EN DIN	UL/CSA
Pushbutton: MP	IP66	Type 1, 3R, 4, 4X, 12, 13
Double pushbutton: MPD	IP66	Type 1, 3R, 4, 4X, 12, 13
Mushroom pushbutton: MPM	IP66	Type 1, 3R, 4, 4X, 12, 13
Emergency stop pushbuttons: MPMT, MPMP, MPET, MPEP, MPEK	IP66	Type 1, 3R, 4, 4X, 12, 13
Selector switch: M2SS, M3SS	IP66	Type 1, 3R, 4, 4X, 12, 13
Key-operated selector switch: M2SSK, M3SSK	IP66	Type 1, 3R, 4, 4X, 12
Toggle switch: MTS2, MTS3	IP66	Type 1, 3R, 4, 4X, 12, 13
Heavy duty pushbutton: KP6	-	Type 1, 3R, 4, 4X
Reset pushbutton: KPR	IP66	Type 1, 3R, 4, 4X, 12, 13
Joystick: MJS	IP66, 67, 69K	Type 1, 4X (indoor), 12, 13
Pilot light: ML	IP66	Type 1, 3R, 4, 4X, 12, 13
Potentiometer: MT	IP66	Type 1, 3R, 4, 4X, 12, 13
Contact block : MCB	IP20	-
Plastic enclosure: MEP	IP66	Type 1, 3R, 4, 4X, 12, 13

Note: Specified degree of protection is for operator mounted on panel. If other items are mounted in between, please make sure that they are correctly sealed.

Temperature

Ambient temperature during operation	-25 to +70 °C
Storage temperature	-40 to +85 °C

Connecting capacity

Contact block type	MCB	MCBL	MLBL
Connection capacity (min. ... max.)			
 Solid/stranded	1x	0.75...2.5 mm ²	
	2x	0.75...2.5 mm ²	
 Flexible	1x	0.75...2.5 mm ²	
	2x	0.75...2.5 mm ²	
 Flexible with non insulated ferrule	1x	0.75...2.5 mm ²	
	2x	0.75...2.5 mm ²	
 Flexible with insulated ferrule	1x	0.75...2.5 mm ²	
	2x	0.75...2.5 mm ²	
 Lugs	L ≤	7.0 mm	
	l >	3.5 mm	
Connection capacity acc. to UL/CSA 1 or 2 x AWG 18...14			
Stripping length 8 mm			
Tightening torque			
Cable terminals M3.5		0.9 Nm	
Recommended screwdriver for cable terminal		Pozidriv No. 2	
Operators locking nut		Min. 2 Nm / Max. 2.3 Nm	

Material

No ozone depleting substances in the products. All front of panel plastic components are made of polycarbonate

Material	Effects
PC polycarbonate	High impact strength, good outdoor resistance. Chemical resistance (see table below)
PSU polysulphone	Can withstand high temperatures, acids, basic solutions, alkaline compounds, oils, alcohols
PA polyamide	Can withstand high temperatures, aliphatic, aromatic and chlorinated hydrocarbons, esters, ketone-aldehydes, alcohols and basic solutions
PBT	Can withstand high temperature, aliphatic and aromatic hydrocarbons, acids, basic solutions, alcohols, grease and oils
Zinc	Good corrosion resistance in inland-, sea and industrial atmosphere
Light-alloy	Good corrosion resistance in inland-, sea and industrial atmosphere

Chemical resistance for polycarbonate

Chemical class	Effects
Alcohols and alkalis	Generally compatible at low concentration and room temperature. Higher concentrations and elevated temperatures can result in etching and attack evidenced by decomposition
Aliphatic hydrocarbons	Generally compatible
Amines	Surface crystallization and chemical attack. Avoid
Aromatic hydrocarbons	Partial solvents and severe stress cracking agents (i.e., xylene, toluene) Avoid
Detergents and cleaners	Mild soap solutions are generally compatible. Strong alkaline materials should be avoided
Esters	Cause severe crystallization. Partial solvents Avoid
Greases and oils	Pure petroleum types generally compatible. Many additives used with them are not
Halogenated, hydrocarbons	Solvents Avoid
Ketones	Cause severe crystallization and stress cracking. Partial solvents Avoid
Silicone oil and greases	Generally compatible up to 85 °C

Modular plastic range

Technical data

Electrical data

MCB Standard contact blocks (standard and gold plated)

Self cleaning silver contacts, NC contact with positive opening.
At voltages and currents below 24 V and 5.6 mA we recommend our micro switch blocks.

Ratings as per IEC 60947-5-1

Rated insulation voltage, U_i	690 V	
Rated thermal current, I_{th}	10 A	
Rated operational current, I_e Utilization category AC 15,	at: 120 V	8 A
	at: 230 V	6 A
	at: 400 V	4 A
	at: 690 V	2 A
Rated operational current, I_e utilisation category DC 13,	at: 24 V	5 A
	at: 125 V	1.1 A
	at: 250 V	0.55 A
Rated impulse withstand voltage	U_{imp}	6 kV

Rated frequency	50/60 Hz	
Pollution degree	3	

Ratings as per UL, CSA, NEMA	A600 AC	Q600 DC		
Rated insulation voltage	600 V	600 V		
Rated thermal current	10 A	2.5 A		
Rated operational current	at: 120 V	6 A	at: 125 V	0.55 A
	at: 240 V	3 A	at: 250 V	0.27 A
	at: 480 V	1.5 A	at: 480 V	0.10 A
	at: 600 V	1.2 A	at: 600 V	0.10 A

Max. number of contact blocks per operator

The contact blocks can be stacked in max two levels on the 3-block holder. Only one level is accepted on the 5-block holder.

Pushbutton, toggle switch, mushroom pushbutton, double pushbutton, selector switch, key-operated selector switch and emergency stop operator	6
Joystick	8

Short circuit protection

Max. fuse at 1 kA

Diagram for make and break contact MCB, MCBL

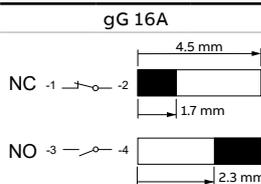

Micro switch block

Ratings as per IEC 60947-5-1		
Rated insulation voltage, U_i	125 V	
Rated thermal current, I_{th}	3 A	
Rated operational current, I_e utilisation category AC 14,	at: 125 V	0.5 A
	at: 24 V	0.3 A
Rated operational current, I_e utilization category DC 13,	at: 24 V	0.1 A
Rated operational current, I_e utilization category DC 12,	at: 24 V	0.1 A

Ratings as per UL 508		
	125 V AC	3 A
	60 V DC	0.2 A
	48 V DC	0.1 A

Minimum switching capacity

Standard contact blocks	24 V DC	5.6 mA
Gold plated contact blocks	5 V DC	12 mA
	12 V DC	1 mA
Micro switch blocks	3 V DC	1 mA

Mechanical data

Mechanical life	
Standard contact blocks MCB	10 million operations
Micro switch block MCBL	1 million operations
Pushbuttons MP, momentary mushroom pushbuttons MPM	2 million operations

Selector switches M2SS, M3SS

Standard contact blocks and micro switch block	3-position holder		500 000 operations
Standard contact blocks	3-position holder		
Standard contact blocks	5-position holder		
Standard contact blocks in two stacks	3-position holder		

Selector switches - center block operating M3SSC

Standard contact blocks	3-position holder		250 000 operations
Standard contact blocks in two stacks	3-position holder		150 000 operations

Key-operated selector switch M2SSK, M3SSK and double pushbutton MPD

Emergency stop pushbuttons MPET, MPEP, MPEK	100 000 operations
---	--------------------

Toggle switch MTS	1 million operations
-------------------	----------------------

Joystick MJS

Micro switch block	4-position holder		500 000 operations
Standard contact blocks	4-position holder		
Standard contact blocks and micro switch block	4-position holder		400 000 operations
Standard contact blocks in two stacks	4-position holder		300 000 operations

LED blocks MLBL

Service life for LED means number of service hours until the brightness has been reduced down 50%. Service life 50 000 h operating at 25 °C, 40-70% rh (relative humidity)

Color of white LED	$x=0.31$ $Y=0.32$ means the position of color in the ICI Chromaticity diagram
Voltage tolerance on LED blocks	-30 to +10% voltage is acceptable without affecting the Service life
Voltage peaks on LED blocks	Voltage peaks up to 1000 V. Current peaks up to 500 mA during a few msec.
Glowing light	All integrated LED bulbs have a function built in to cut leakage currents
Rated frequency	50/60 Hz for AC supplied products

Modular plastic range

Technical data

LED blocks front and rear mounting MLBL

Color	Current		Illuminance		Anti ... inductive peak voltage V	Main wavelength Nm	Color temperature K
	mA Min.	Max.	lx Min.	Max.			
Voltage range 12 V DC							
● Red	11	15	1000	3500	5	620 ... 625	–
● Green	8	12	3700	12500	5	515 ... 520	–
● Yellow	11	15	1200	4250	5	585 ... 590	–
● Blue	8	12	1500	5300	5	465 ... 470	–
○ Clear	8	12	1800	8500	5	–	8000 ... 12000
Voltage range 24 V AC / DC							
● Red	8	12	900	3100	5	620 ... 625	–
● Green	8	12	3000	11500	5	515 ... 520	–
● Yellow	8	12	1000	3400	5	585 ... 590	–
● Blue	8	12	1500	5300	5	465 ... 470	–
○ Clear	8	11	1800	8500	5	–	8000 ... 12000
Voltage range 48 V AC / DC							
● Red	8	12	900	3100	5	620 ... 625	–
● Green	8	12	3000	11500	5	515 ... 520	–
● Yellow	8	12	1000	3400	5	585 ... 590	–
● Blue	8	12	1500	5300	5	465 ... 470	–
○ Clear	8	12	1800	8500	5	–	8000 ... 12000
Voltage range 60 V AC / DC							
● Red	8	12	900	3100	5	620 ... 625	–
● Green	8	12	3000	11500	5	515 ... 520	–
● Yellow	8	12	1000	3400	5	585 ... 590	–
● Blue	8	12	1500	5300	5	465 ... 470	–
○ Clear	8	12	1800	8500	5	–	8000 ... 12000
Voltage range 110 ... 130 V AC							
● Red	8	12	900	3100	15	620 ... 625	–
● Green	8	12	3200	12000	15	515 ... 520	–
● Yellow	8	12	1000	3700	15	585 ... 590	–
● Blue	8	12	1550	5500	15	465 ... 470	–
○ Clear	8	12	1850	8800	15	–	8000 ... 12000
Voltage range 110 ... 130 V AC high anti-inductive voltage (1)							
● Red	14	16	700	2600	25	620 ... 625	–
● Green	14	16	2100	8200	25	515 ... 520	–
● Yellow	14	16	750	3000	25	585 ... 590	–
● Blue	14	16	1000	5000	25	465 ... 470	–
○ Clear	14	16	1500	8100	25	–	8000 ... 12000
Voltage range 110 ... 130 V DC							
● Red	8	12	900	3100	15	620 ... 625	–
● Green	8	12	3000	11500	15	515 ... 520	–
● Yellow	8	12	1000	3400	15	585 ... 590	–
● Blue	8	12	1500	5300	15	465 ... 470	–
○ Clear	8	12	1800	8500	15	–	8000 ... 12000

Note:

The testing distance of illuminance is 2 mm, between top of lens and the sensor surface. Clean test environment, supply voltage at 50/60 Hz with harmonized wave and without length high frequency.

Rated voltage tolerance of LED blocks: -30% to +10%.

(1) Higher threshold to light up LED to be used in applications where there is risk of large induced voltages.

Modular plastic range

Technical data

Color	Current		Illuminance		Anti-inductive peak voltage V	Main wavelength Nm	Color temperature K
	mA Min.	Max.	lx Min.	Max.			
Voltage range 220 V DC							
● Red	7	10	700	2300	15	620 ... 625	–
● Green	7	10	2400	8000	15	515 ... 520	–
● Yellow	7	10	800	3100	15	585 ... 590	–
● Blue	7	10	1200	4350	15	465 ... 470	–
○ Clear	7	10	1400	7000	15	–	8000 ... 12000
Voltage range 230 V AC							
● Red	8	12	900	3100	15	620 ... 625	–
● Green	8	12	3000	11500	15	515 ... 520	–
● Yellow	8	12	1000	3400	15	585 ... 590	–
● Blue	7	11	1500	5300	15	465 ... 470	–
○ Clear	7	11	1800	8500	15	–	8000 ... 12000
Voltage range 380 V AC							
● Red	8	12	900	3100	15	620 ... 625	–
● Green	8	12	3000	11500	15	515 ... 520	–
● Yellow	8	12	1000	3400	15	585 ... 590	–
● Blue	8	12	1500	5300	15	465 ... 470	–
○ Clear	8	12	1800	8500	15	–	8000 ... 12000
Voltage range 415 V AC							
● Red	8	12	900	3100	15	620 ... 625	–
● Green	8	12	3000	11500	15	515 ... 520	–
● Yellow	8	12	1000	3400	15	585 ... 590	–
● Blue	8	12	1500	5300	15	465 ... 470	–
○ Clear	8	12	1800	8500	15	–	8000 ... 12000
Voltage range 230 V AC high anti-inductive voltage (1)							
● Red	8	12	480	1700	55	620 ... 625	–
● Green	6	11	1500	5800	55	515 ... 520	–
● Yellow	8	12	530	1900	55	585 ... 590	–
● Blue	6	11	850	3100	55	465 ... 470	–
○ Clear	6	11	1000	5200	55	–	8000 ... 12000

Note:

The testing distance of illuminance is 2 mm, between top of lens and the sensor surface. Clean test environment, supply voltage at 50/60 Hz with harmonized wave and without length high frequency.

Rated voltage tolerance of LED blocks: ... 30% to +10%.

(1) Higher threshold to light up LED to be used in applications where there is risk of large induced voltages.

Modular plastic range

Drilling plan

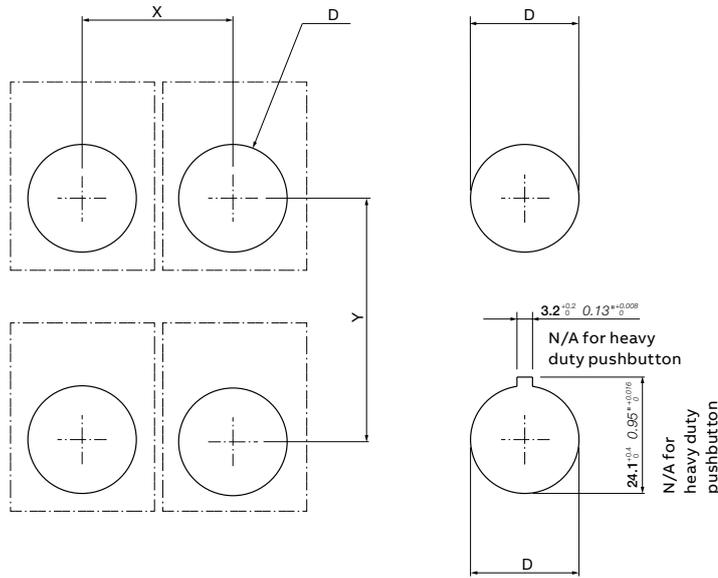

Description	X	Y	D		Panel thickness
			Ø mm	inch	
Pushbutton, pilot light, selector switch short handle, potentiometer, toggle switch, 30 mm emergency stop, key-operated selector switch	31 1.22"	50 1.97"	Ø 22.3 ^{+0.4} ₀	0.88" ^{+0.016} ₀	1.5 0.06" - 6 0.24"
Pushbutton, pilot light, selector switch short handle (with legend plate)	31 1.22"	55 2.17"	Ø 22.3 ^{+0.4} ₀	0.88" ^{+0.016} ₀	1.5 0.06" - 6 0.24"
Mushroom pushbutton, emergency stop, machine stop (60 mm)	45 1.77"	50 1.97"	Ø 22.3 ^{+0.4} ₀	0.88" ^{+0.016} ₀	1.5 0.06" - 6 0.24"
Mushroom pushbutton, emergency stop, machine stop (40 mm)	65 2.56"	70 2.76"	Ø 22.3 ^{+0.4} ₀	0.88" ^{+0.016} ₀	1.5 0.06" - 6 0.24"
Double pushbutton	31 1.22"	55 2.17"	Ø 22.3 ^{+0.4} ₀	0.88" ^{+0.016} ₀	1.5 0.06" - 6 0.24"
Double pushbutton (with legend plate)	31 1.22"	95 3.74"	Ø 22.3 ^{+0.4} ₀	0.88" ^{+0.016} ₀	1.5 0.06" - 6 0.24"
Heavy duty pushbutton	50 1.97"	50 1.97"	Ø 30.5 ^{+0.5} ₀	1.20" ^{+0.02} ₀	2 0.08" - 5 0.20"
Potentiometer (with legend plate)	51 2.01"	50 1.97"	Ø 22.3 ^{+0.4} ₀	0.88" ^{+0.016} ₀	1.5 0.06" - 6 0.24"
Toggle switch (with legend plate)	31 1.22"	66 2.60"	Ø 22.3 ^{+0.4} ₀	0.88" ^{+0.016} ₀	1.5 0.06" - 6 0.24"
Joystick (with legend plate)	100 3.94"	100 3.94"	Ø 22.3 ^{+0.4} ₀	0.88" ^{+0.016} ₀	1.5 0.06" - 6 0.24"

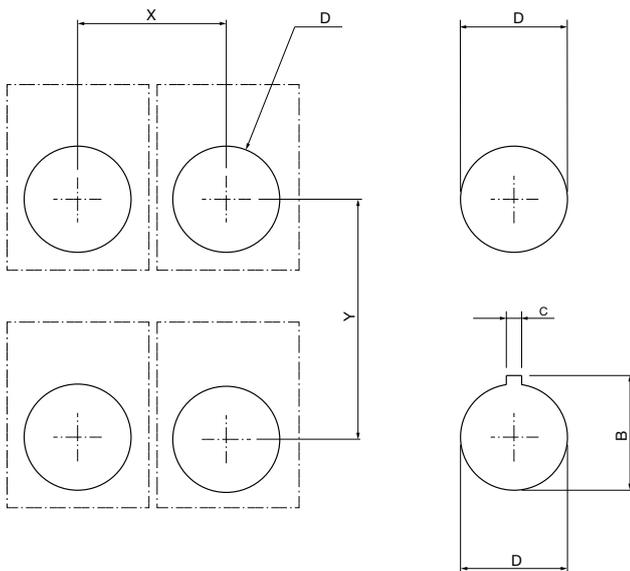

Accessories	X	Y	D		B		C	Panel thickness
			Ø mm	inch	Ø mm	inch		
5 block holder	51 2.01"	50 1.97"	Ø 22.3 ^{+0.4} ₀	0.88" ^{+0.016} ₀	24.1 ^{+0.4} ₀	0.95" ^{+0.016} ₀	3.2 0.13"	1.5 0.06" - 6 0.24"
30 mm adaptor	42 1.65"	52 2.05"	Ø 30.5 ^{+0.5} ₀	1.20" ^{+0.02} ₀	33 ^{+0.5} ₀	1.30" ^{+0.02} ₀	5 0.20"	2 0.08" - 7 0.28"

Pilot devices, 22 mm

Modular metal range

Ordering details

56	Non-illuminated pushbuttons momentary
57	Non-illuminated marked pushbuttons momentary
58	Illuminated pushbuttons momentary
59	Non-illuminated mushroom pushbuttons
60	Illuminated mushroom pushbuttons
61	Pilot lights
62	Non-illuminated selector switches - 2-position
63	Illuminated selector switches - 2-position
64	Non-illuminated selector switches - 3-position
65	Illuminated selector switches - 3-position
66	Non-illuminated selector switches
68	Key-operated selector switches
72	Joysticks
74	Toggle switches
75	Selector pushbuttons

Accessories for modular range

76	Holders and contact blocks for front mounting
77	Power supplies
78	LED bulbs for power supplies
79	LED blocks for front mounting
80	Accessories
81	Metal enclosures

83 Technical data

85 Dimension

86 Drilling plan

Modular metal range

Non-illuminated pushbuttons momentary



1SFC151476V0001

P9MPNRG with holder



1SFC151529V0001

P9MPNGG



1SFC151510V0001

P9MPN BG



1SFC151526V0001

P9MPNNG



1SFC151519V0001

P9MPNRS



1SFC151518V0001

P9MPNVS



1SFC151521V0001

P9MPNLS



1SFC151520V0001

P9MPNNS



1SFC151628V0001

P9ACDPP

Description

Each reference includes the satin chrome metal body and nut together with the holder.

Operator	Type	Order code	Pkg qty	Weight (1 pce) kg
Flush pushbutton				
● Red	P9MPNRG	1SFA184001R9001	1	0.058
● Green	P9MPNVG	1SFA184002R9002	1	0.058
● Yellow	P9MPNGG	1SFA184003R9003	1	0.058
● Blue	P9MPN LG	1SFA184006R9004	1	0.058
○ White	P9MPN BG	1SFA184007R9005	1	0.058
● Black	P9MPN NG	1SFA184000R9006	1	0.058
● Grey	P9MPN HG	1SFA184008R9007	1	0.058
Extended pushbutton				
● Red	P9MPNRS	1SFA184011R9001	1	0.062
● Green	P9MPNVS	1SFA184012R9002	1	0.062
● Yellow	P9MPNGS	1SFA184057R9003	1	0.062
● Blue	P9MPNLS	1SFA184016R9004	1	0.062
○ White	P9MPNBS	1SFA184017R9005	1	0.062
● Black	P9MPNNS	1SFA184010R9006	1	0.062
Maintained accessory				
Device for standard pushbuttons, illuminated pushbuttons: To be used only with contact blocks P9B01VN, P9B01VR, P9B10VA and P9B01FN	P9ACDPP	1SFA187843R8000	1	0.012

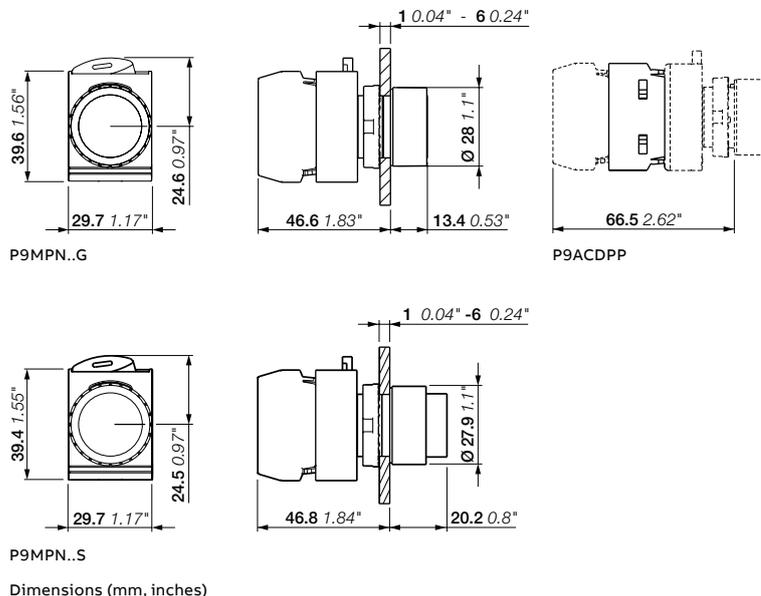

Modular metal range

Non-illuminated marked pushbuttons momentary



Flush pushbuttons

Each reference includes the satin chrome metal body and nut together with the holder.

Text/symbol	Color	Type	Order code	Pkg qty	Weight (1 pce) kg
Flush pushbuttons					
START	Green	P9MPNVG202	1SFA187149R9502	1	0.058
STOP	Red	P9MPNRG201	1SFA187147R9501	1	0.058
	Black	P9MPNNG201	1SFA188908R9506	1	0.058
R	Blue	P9MPNNG037	1SFA187143R9504	1	0.058
⊕	Green	P9MPNVG030	1SFA187146R9502	1	0.058
	White	P9MPNBG030	1SFA188057R9505	1	0.058
	Black	P9MPNNG030	1SFA187145R9506	1	0.058
I	Green	P9MPNVG028	1SFA187112R9502	1	0.058
	White	P9MPNBG028	1SFA187151R9505	1	0.058
	Black	P9MPNNG028	1SFA187111R9506	1	0.058
O	Red	P9MPNRG029	1SFA187110R9501	1	0.058
	Black	P9MPNNG029	1SFA187150R9506	1	0.058
→	Green	P9MPNVG006	1SFA187118R9502	1	0.058
	White	P9MPNBG006	1SFA187152R9505	1	0.058
	Black	P9MPNNG006	1SFA187117R9506	1	0.058
↯	Black	P9MPNNG085	1SFA188886R9506	1	0.058
↔	Blue	P9MPNNG007	1SFA188900R9504	1	0.058
⚙	Black	P9MPNNG002	1SFA187139R9506	1	0.058
Extended pushbutton					
O	Red	P9MPNRS029	1SFA187210R9501	1	0.058
O	Black	P9MPNNS029	1SFA187250R9506	1	0.058
⬆	Black	P9MPNNS032	1SFA187235R9506	1	0.058

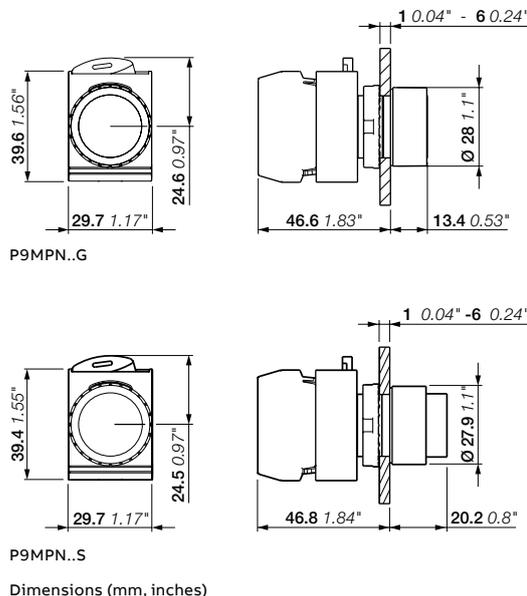

Modular metal range

Illuminated pushbuttons momentary



Description

Each reference includes the satin chrome metal body and nut together with the holder.

Operator	Type	Order code	Pkg qty	Weight (1 pce) kg
----------	------	------------	---------	-------------------

Flush pushbutton - Plastic lens type

● Red	P9MPLRGD	1SFA184491R9101	1	0.057
● Green	P9MPLVGD	1SFA184492R9102	1	0.057
● Yellow	P9MPLGGD	1SFA184493R9103	1	0.057
● Blue	P9MPLLGD	1SFA184496R9104	1	0.057
○ White	P9MPLBGD	1SFA184497R9105	1	0.057
● Orange	P9MPLAGD	1SFA184495R9109	1	0.057
○ Clear	P9MPLIGD	1SFA184498R9108	1	0.057

Flush pushbutton - Glass lens type

● Red	P9MPLRGV	1SFA184521R9101	1	0.060
● Green	P9MPLVGV	1SFA184522R9102	1	0.060
● Yellow	P9MPLGGV	1SFA184523R9103	1	0.060
● Blue	P9MPLLGV	1SFA184526R9104	1	0.060
○ White	P9MPLBGV	1SFA184527R9105	1	0.060

Extended pushbutton - Plastic lens type

● Red	P9MPLRSD	1SFA184501R9101	1	0.059
● Green	P9MPLVSD	1SFA184502R9102	1	0.059
● Yellow	P9MPLGSD	1SFA184503R9103	1	0.059
● Blue	P9MPLLSD	1SFA184506R9104	1	0.059
○ White	P9MPLBSD	1SFA184507R9105	1	0.059
● Orange	P9MPLASD	1SFA184505R9109	1	0.059

Maintained accessory

Device for standard pushbuttons, illuminated pushbuttons: To be used only with contact blocks P9B01VN, P9B01VR, P9B10VA and P9B01FN	P9ACDPP	1SFA187843R8000	1	0.012
--	---------	-----------------	---	-------

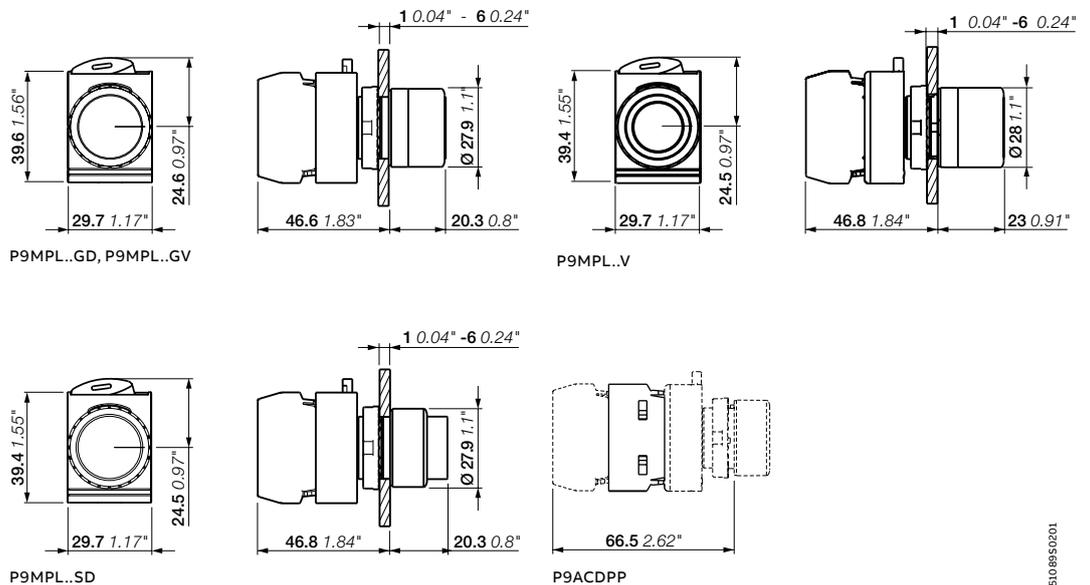

Modular metal range

Non-illuminated mushroom pushbuttons

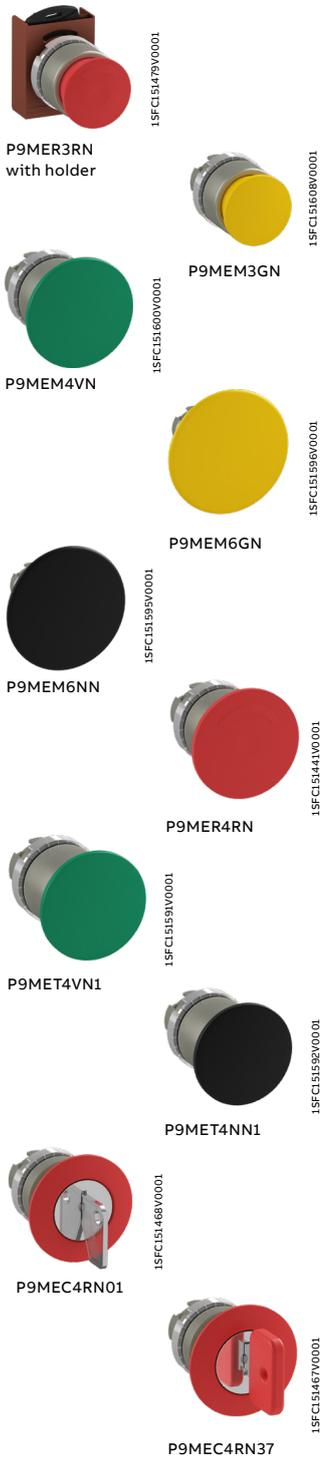

Description

Each reference includes the satin chrome metal body and nut together with the holder.

Color	Release method	Type	Order code	Pkg qty	Weight (1 pce) kg
Momentary					
Ø 28 mm					
● Red	–	P9MEM3RN	1SFA184031R9001	1	0.060
● Green	–	P9MEM3VN	1SFA184032R9002	1	0.060
● Yellow	–	P9MEM3GN	1SFA184033R9003	1	0.060
● Black	–	P9MEM3NN	1SFA184030R9006	1	0.060
Ø 40 mm					
● Red	–	P9MEM4RN	1SFA184041R9001	1	0.061
● Green	–	P9MEM4VN	1SFA184042R9002	1	0.061
● Yellow	–	P9MEM4GN	1SFA184043R9003	1	0.061
● Black	–	P9MEM4NN	1SFA184040R9006	1	0.061
Ø 60 mm					
● Red	–	P9MEM6RN	1SFA184051R9001	1	0.070
● Green	–	P9MEM6VN	1SFA184052R9002	1	0.070
● Yellow	–	P9MEM6GN	1SFA184053R9003	1	0.070
● Black	–	P9MEM6NN	1SFA184050R9006	1	0.070
Maintained					
Ø 28 mm					
● Red	Twist release	P9MER3RN	1SFA184070R9001	1	0.066
Ø 40 mm					
● Red	Pull release	P9MET4RN1	1SFA184061R9001	1	0.069
	Twist release	P9MER4RN	1SFA184071R9001	1	0.069
● Green	Pull release	P9MET4VN1	1SFA184062R9002	1	0.069
● Yellow	Pull release	P9MET4GN1	1SFA184063R9003	1	0.069
● Black	Pull release	P9MET4NN1	1SFA184060R9006	1	0.069
Maintained with key					
Ø 40 mm					
● Red	Key code 01	P9MEC4RN01	1SFA192000R9001	1	0.090
	Key code 37	P9MEC4RN37	1SFA192012R9001	1	0.090
	Key code 95	P9MEC4RN95	1SFA184073R9001	1	0.090

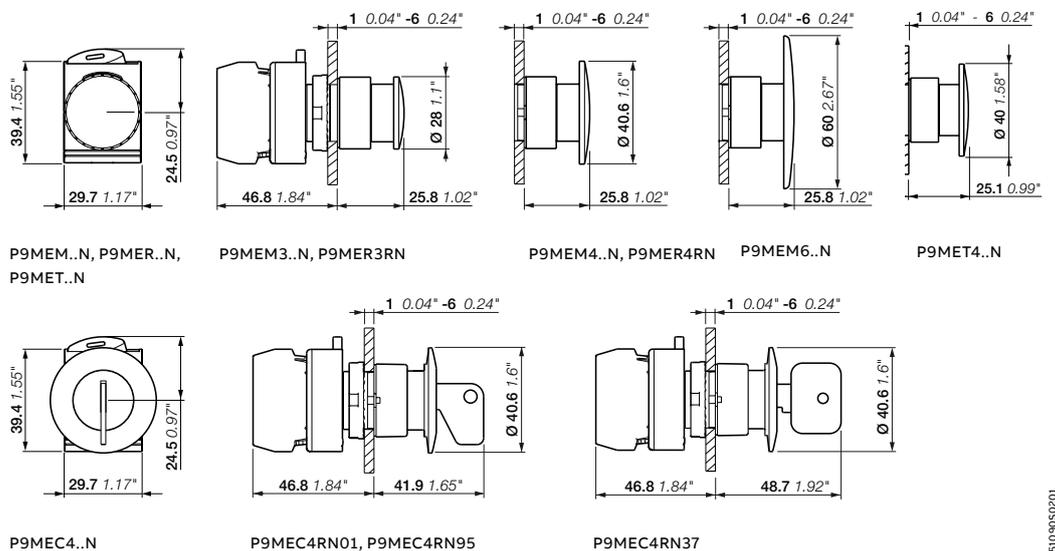

Modular metal range

Illuminated mushroom pushbuttons



P9MEM4RL

1SFC151602V0001



P9MEM4GL

1SFC151604V0001



P9MET4RL1

1SFC151888V0001



P9MET4LL1

1SFC151887V0001

Description

Each reference includes the satin chrome metal body and nut together with the holder.

Color	Release method	Type	Order code	Pkg qty	Weight (1 pce) kg
-------	----------------	------	------------	---------	-------------------

Momentary

Ø 40 mm

● Red	-	P9MEM4RL	1SFA184551R9101	1	0.062
● Green	-	P9MEM4VL	1SFA184552R9102	1	0.062
● Yellow	-	P9MEM4GL	1SFA184553R9103	1	0.062
● Blue	-	P9MEM4LL	1SFA184556R9104	1	0.062

Maintained

Ø 40 mm

● Red	Pull release	P9MET4RL1	1SFA184561R9101	1	0.062
● Green	Pull release	P9MET4VL1	1SFA184562R9102	1	0.062
● Yellow	Pull release	P9MET4GL1	1SFA184563R9103	1	0.062
● Blue	Pull release	P9MET4LL1	1SFA184566R9104	1	0.062

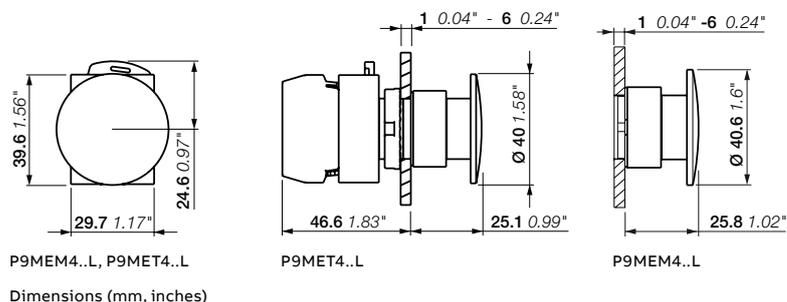

Modular metal range

Pilot lights



P9MLBD
with holder

1SFC151478V0001



P9MLRD

1SFC151579V0001



P9MLVD

1SFC151578V0001



P9MLGD

1SFC151582V0001



P9MLLD

1SFC151580V0001



P9MLID

1SFC151581V0001



P9MLAD

1SFC151584V0001

Description

Each reference includes the satin chrome metal body and nut together with the holder.

Color	Type	Order code	Pkg qty	Weight (1 pce) kg
Operator - Plastic lens type				
● Red	P9MLRD	1SFA184791R9001	1	0.050
● Green	P9MLVD	1SFA184792R9002	1	0.050
● Yellow	P9MLGD	1SFA184793R9003	1	0.050
● Blue	P9MLLD	1SFA184796R9004	1	0.050
○ White	P9MLBD	1SFA184797R9005	1	0.050
○ Clear	P9MLID	1SFA184798R9008	1	0.050
● Orange	P9MLAD	1SFA184795R9009	1	0.050

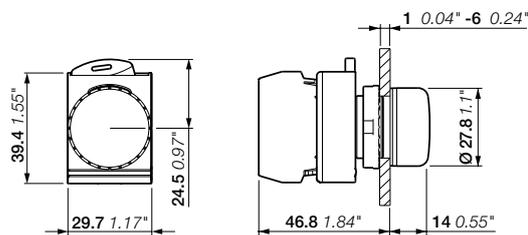

P9ML...D

Dimensions (mm, inches)

Modular metal range

Non-illuminated selector switches - 2-position



Description

Each reference includes the satin chrome metal body and nut together with the holder.

Operating principle	Color	CAM function	Type	Order code	Pkg qty	Weight (1 pce) kg
Short handle						
	● Yellow	I	P9MSMI0G	1SFA184123R9003	1	0.065
	● Black	I	P9MSMI0N	1SFA184120R9006	1	0.065
	● Red	D	P9MSMD0R	1SFA184111R9001	1	0.065
	● Black	D	P9MSMD0N	1SFA184110R9006	1	0.065
	● Red	I	P9MSMI5R	1SFA184151R9001	1	0.065
	● Green	I	P9MSMI5V	1SFA184152R9002	1	0.065
	● Black	I	P9MSMI5N	1SFA184150R9006	1	0.065
	● Red	D	P9MSMD5R	1SFA184141R9001	1	0.065
	● Yellow	D	P9MSMD5G	1SFA184143R9003	1	0.065
	● Black	D	P9MSMD5N	1SFA184140R9006	1	0.065
Long handle						
	● Black	I	P9MSVI0N	1SFA184371R9006	1	0.068
	● Yellow	D	P9MSVD0G	1SFA184822R9003		
	● Black	D	P9MSVD0N	1SFA184370R9006	1	0.068
	● Black	I	P9MSVI5N	1SFA184374R9006	1	0.068
	● Black	D	P9MSVD5N	1SFA184373R9006	1	0.068

Electrical diagram

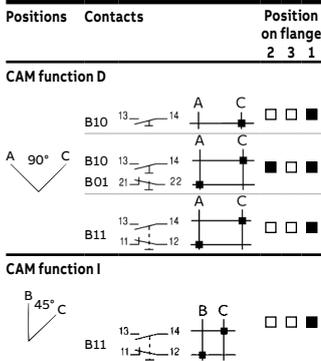

Note: dot in this diagram = contact closed.
 B10 = P9B10VN, P9B10FN contact blocks
 B01 = P9B01VN, P9B01FN contact blocks
 B11 = P9B11VN contact blocks

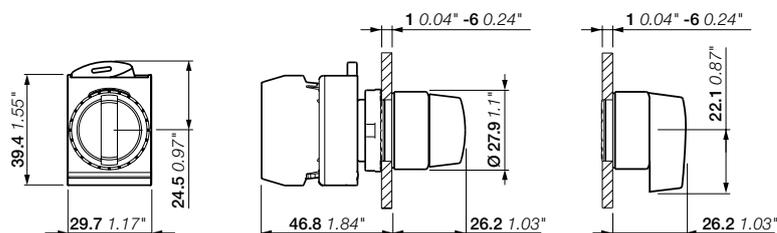

P9MSM, P9MSV
 Dimensions (mm, inches)

Modular metal range

Illuminated selector switches - 2-position



Description

Each reference includes the satin chrome metal body and nut together with the holder.

Operating principle	Color	CAM function	Type	Order code	Pkg qty	Weight (1 pce) kg
Short handle						
	● Red	D	P9MSLD0R	1SFA184591R9101	1	0.059
	● Green	D	P9MSLD0V	1SFA184592R9102	1	0.059
	● Yellow	D	P9MSLD0G	1SFA184593R9103	1	0.059
	● Blue	D	P9MSLD0L	1SFA184596R9104	1	0.059
	○ White	D	P9MSLD0B	1SFA184597R9105	1	0.059
	● Orange	D	P9MSLD0A	1SFA184595R9109	1	0.059
	○ Clear	D	P9MSLD0I	1SFA184598R9108	1	0.059
Long handle						
	● Red	D	P9MSAD0R	1SFA184641R9101	1	0.060
	● Green	D	P9MSAD0V	1SFA184642R9102	1	0.060
	● Blue	D	P9MSAD0L	1SFA184646R9104	1	0.060
	○ White	D	P9MSAD0B	1SFA184647R9105	1	0.060

Electrical diagram

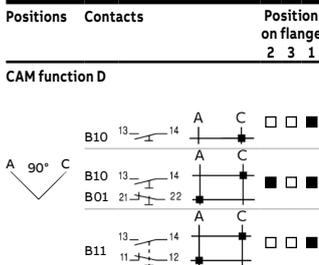

Note: dot in this diagram = contact closed.
 B10 = P9B10VN, P9B10FN contact blocks
 B01 = P9B01VN, P9B01FN contact blocks
 B11 = P9B11VN contact blocks

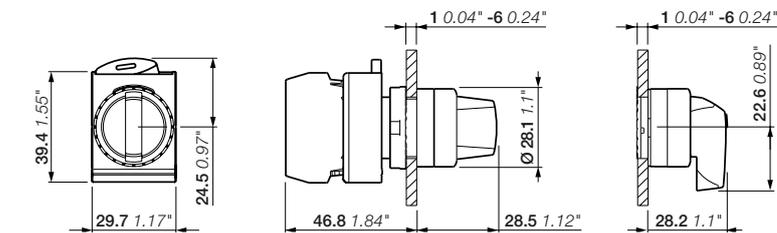

P9MSL, P9MSA
 Dimensions (mm, inches)

Modular metal range

Non-illuminated selector switches - 3-position



Description

Each reference includes the satin chrome metal body and nut together with the holder.

Operating principle	Color	CAM function	Type	Order code	Pkg qty	Weight (1 pce) kg
Short handle						
	● Red	Z	P9MSMZ0R	1SFA184201R9001	1	0.065
	● Black	Z	P9MSMZ0N	1SFA184200R9006	1	0.065
	● Red	Z	P9MSMZ3R	1SFA184321R9001	1	0.065
	● Black	Z	P9MSMZ3N	1SFA184320R9006	1	0.065
	● Black	Z	P9MSMZ5N	1SFA184280R9006	1	0.065
	● Red	Z	P9MSMZ1R	1SFA184241R9001	1	0.065
	● Black	Z	P9MSMZ1N	1SFA184240R9006	1	0.065
Long handle						
	● Red	Z	P9MSVZ0R	1SFA184856R9001	1	0.068
	● Black	Z	P9MSVZ0N	1SFA184379R9006	1	0.068
	● Black	Z	P9MSVZ3N	1SFA184391R9006	1	0.068
	● Black	Z	P9MSVZ5N	1SFA184387R9006	1	0.068
	● Black	Z	P9MSVZ1N	1SFA184383R9006	1	0.068

Electrical diagram

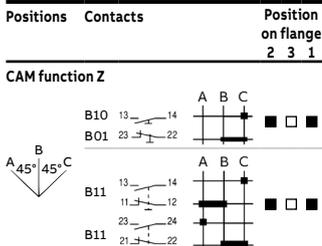

Note: dot in this diagram = contact closed.
 B10 = P9B10VN, P9B10FN contact blocks
 B01 = P9B01VN, P9B01FN contact blocks
 B11 = P9B11VN contact blocks

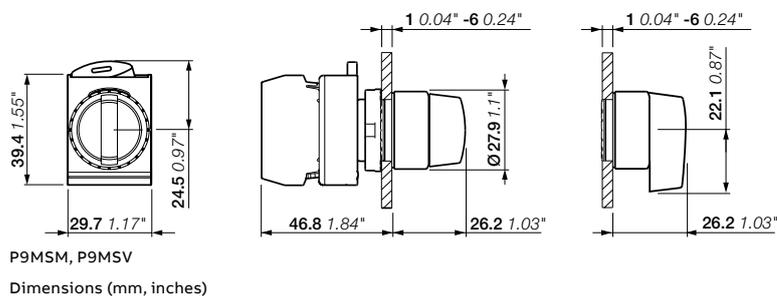

Modular metal range

Illuminated selector switches - 3-position



Description

Each reference includes the satin chrome metal body and nut together with the holder.

Operating principle	Color	CAM function	Type	Order code	Pkg qty	Weight (1 pce) kg
Short handle						
	● Red	Z	P9MSLZ0R	1SFA184601R9101	1	0.065
	● Green	Z	P9MSLZ0V	1SFA184602R9102	1	0.065
	● Yellow	Z	P9MSLZ0G	1SFA184603R9103	1	0.065
	● Blue	Z	P9MSLZ0L	1SFA184606R9104	1	0.065
	○ White	Z	P9MSLZ0B	1SFA184607R9105	1	0.065
	● Orange	Z	P9MSLZ0A	1SFA184605R9109	1	0.065
	● Red	Z	P9MSLZ3R	1SFA184631R9101	1	0.065
	● Green	Z	P9MSLZ3V	1SFA184632R9102	1	0.065
	● Yellow	Z	P9MSLZ3G	1SFA184633R9103	1	0.065
	● Blue	Z	P9MSLZ3L	1SFA184636R9104	1	0.065
	○ White	Z	P9MSLZ3B	1SFA184637R9105	1	0.065
	● Orange	Z	P9MSLZ3A	1SFA184635R9109	1	0.065
	○ Clear	Z	P9MSLZ3I	1SFA184638R9108	1	0.065
	● Red	Z	P9MSLZ5R	1SFA184621R9101	1	0.065
	● Green	Z	P9MSLZ5V	1SFA184622R9102	1	0.065
	● Blue	Z	P9MSLZ5L	1SFA184626R9104	1	0.065
	○ Clear	Z	P9MSLZ5I	1SFA184628R9108	1	0.065
	● Red	Z	P9MSLZ1R	1SFA184611R9101	1	0.065
	● Green	Z	P9MSLZ1V	1SFA184612R9102	1	0.065
	● Yellow	Z	P9MSLZ1G	1SFA184613R9103	1	0.065
	● Blue	Z	P9MSLZ1L	1SFA184616R9104	1	0.065
	○ White	Z	P9MSLZ1B	1SFA184617R9105	1	0.065
	Long handle					
	● Green	Z	P9MSAZ0V	1SFA184652R9102	1	0.068
	○ White	Z	P9MSAZ0B	1SFA184657R9105	1	0.068
	● Green	Z	P9MSAZ3V	1SFA184682R9102	1	0.068
	○ White	Z	P9MSAZ3B	1SFA184687R9105	1	0.068
	● Orange	Z	P9MSAZ3A	1SFA184685R9109	1	0.068

Electrical diagram

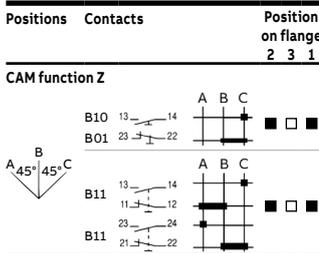

Note: dot in this diagram = contact closed.
 B10 = P9B10VN, P9B10FN contact blocks
 B01 = P9B01VN, P9B01FN contact blocks
 B11 = P9B11VN contact blocks

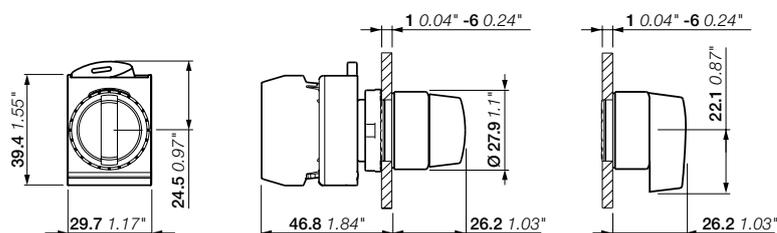

P9MSL, P9MSA
 Dimensions (mm, inches)

Modular metal range

Non-illuminated selector switches - 4-position



1SFCL51471V0001

P9MSMX0N with holder



P9MSMX0N

1SFCL51508V0001

Description

Each reference includes the satin chrome metal body and nut together with the holder.

Operating principle	Color	CAM function	Type	Order code	Pkg qty	Weight (1 pce) kg
Short handle						
	● Black	X	P9MSMX0N	1SFA184397R9006	1	0.065
	● Black	X	P9MSMX5N	1SFA184340R9006	1	0.065
Long handle						
	● Black	X	P9MSVX0N	1SFA184392R9006	1	0.068
	● Black	X	P9MSVX5N	1SFA184393R9006	1	0.068

Electrical diagram

Positions	Contacts	Position on flange
		2 3 1

CAM function X

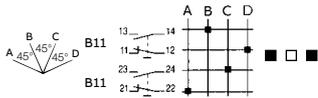

Note: dot in this diagram = contact closed.
 B10 = P9B10VN, P9B10FN contact blocks
 B01 = P9B01VN, P9B01FN contact blocks
 B11 = P9B11VN contact blocks

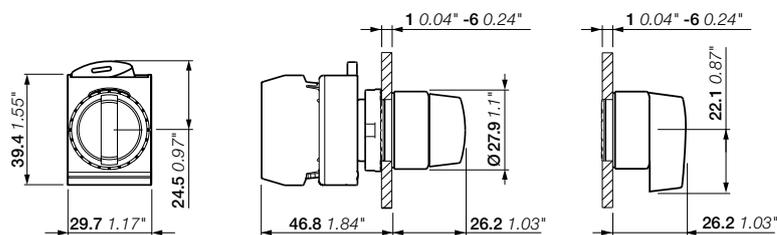

P9MSM, P9MSV
 Dimensions (mm, inches)

Modular metal range

Non-illuminated selector switches - 5-position



1SFC1511V0001

P9MSMYOR

Description

Each reference includes the satin chrome metal body and nut together with the holder.

Operating principle	Color	CAM function	Type	Order code	Pkg qty	Weight (1 pce) kg
Short handle						
	● Black	W	P9MSMW0N	1SFA184360R9006	1	0.065
	● Red	Y	P9MSMYOR	1SFA184351R9001	1	0.065
	● Black	Y	P9MSMY0N	1SFA184350R9006	1	0.065

Electrical diagram

Positions	Contacts	Position on flange
		2 3 1

CAM function Y

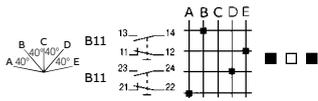

CAM function W

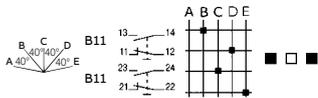

Note: dot in this diagram = contact closed.
 B10 = P9B10VN, P9B10FN contact blocks
 B01 = P9B01VN, P9B01FN contact blocks
 B11 = P9B11VN contact blocks

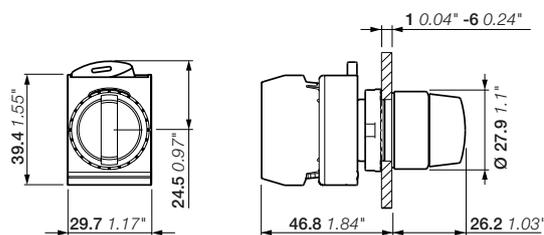

P9MSM

Dimensions (mm, inches)

Modular metal range

Key-operated selector switches - 2-position



Description

Each reference includes the satin chrome metal body and nut together with the holder, 2 keys included.

Operating principle	Key code	Key head color	CAM function	Type	Order code	Pkg qty	Weight (1 pce) kg
 Key can be removed in B only	37	Red/Metal	I	P9MSCI0C37	1SFA192162R9006	1	0.120
	01	Metal	I	P9MSCI0C01	1SFA192150R9006	1	0.120
	95	Metal	I	P9MSCI0C95	1SFA184403R9006	1	0.120
 Key can be removed in C only	01	Metal	I	P9MSCI0E01	1SFA192165R9006	1	0.120
	95	Metal	I	P9MSCI0E95	1SFA184404R9006	1	0.120
 Key can be removed in B and C	95	Metal	I	P9MSCI0N95	1SFA184405R9006	1	0.120
 Key can be removed in A only	37	Red/Metal	D	P9MSCD0A37	1SFA192117R9006	1	0.120
	01	Metal	D	P9MSCD0A01	1SFA192105R9006	1	0.120
	95	Metal	D	P9MSCD0A95	1SFA184400R9006	1	0.120
 Key can be removed in C only	01	Metal	D	P9MSCD0E01	1SFA192120R9006	1	0.120
	95	Metal	D	P9MSCD0E95	1SFA184401R9006	1	0.120
 Key can be removed in A and C positions	37	Red/Metal	D	P9MSCD0K37	1SFA192147R9006	1	0.120
	01	Metal	D	P9MSCD0K01	1SFA192135R9006	1	0.120
	95	Metal	D	P9MSCD0K95	1SFA184402R9006	1	0.120
 Key can be removed in B position	37	Red/Metal	I	P9MSCI5C37	1SFA192267R9006	1	0.120
	01	Metal	I	P9MSCI5C01	1SFA192255R9006	1	0.120
	95	Metal	I	P9MSCI5C95	1SFA184410R9006	1	0.120
 Key can be removed in A position	37	Red/Metal	D	P9MSCD5A37	1SFA192252R9006	1	0.120
	01	Metal	D	P9MSCD5A01	1SFA192240R9006	1	0.120
	95	Metal	D	P9MSCD5A95	1SFA184409R9006	1	0.120
	33	Yellow	D	P9MSCD5A33	1SFA192250R9006	1	0.120

Electrical diagram

Positions	Contacts	Position on flange
		2 3 1

CAM function D

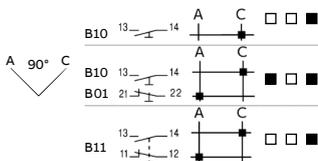

CAM function I

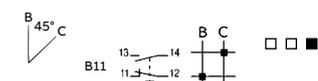

Note: dot in this diagram = contact closed.
 B10 = P9B10VN, P9B10FN contact blocks
 B01 = P9B01VN, P9B01FN contact blocks
 B11 = P9B11VN contact blocks

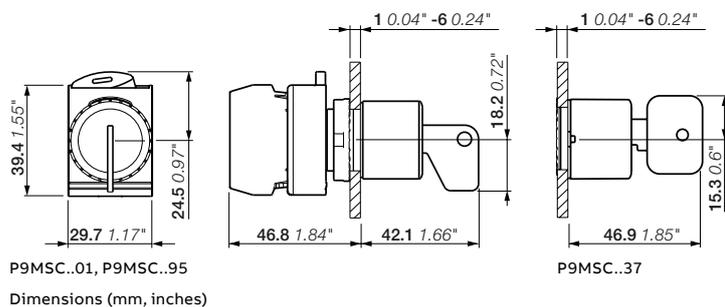

Modular metal range

Key-operated selector switches - 3-position



P9MSCZ0T37 with holder

P9MSCZ0T95

Electrical diagram

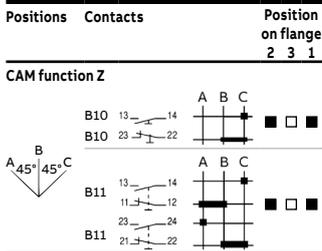

Note: dot in this diagram = contact closed.
 B10 = P9B10VN, P9B10FN contact blocks
 B01 = P9B01VN, P9B01FN contact blocks
 B11 = P9B11VN contact blocks

Description

Each reference includes the satin chrome metal body and nut together with the holder, 2 keys included.

Operating principle	Key code	Key head color	CAM function	Type	Order code	Pkg qty	Weight (1 pce) kg
	37	Red/Metal	Z	P9MSCZ0T37	1SFA192702R9006	1	0.120
	01	Metal	Z	P9MSCZ0T01	1SFA192690R9006	1	0.120
	95	Metal	Z	P9MSCZ0T95	1SFA184439R9006	1	0.120
Key can be removed in all positions	95	Metal	Z	P9MSCZ0A95	1SFA184433R9006	1	0.120
Key can be removed in A position only	95	Metal	Z	P9MSCZ0C95	1SFA184434R9006	1	0.120
Key can be removed in B position only	95	Metal	Z	P9MSCZ0H95	1SFA184436R9006	1	0.120
Key can be removed in A and B positions	95	Metal	Z	P9MSCZ0N95	1SFA184438R9006	1	0.120
Key can be removed in B and C positions	95	Metal	Z	P9MSCZ1C95	1SFA184449R9006	1	0.120
Key can be removed in A and C positions	95	Metal	Z	P9MSCZ1N95	1SFA184451R9006	1	0.120

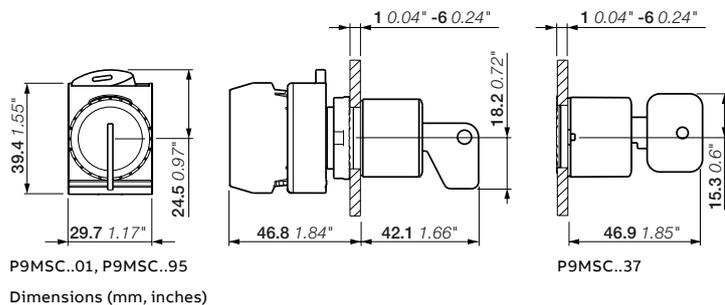

Modular metal range

Key-operated selector switches - 3-position



P9MSCZ3C01 with holder

Electrical diagram

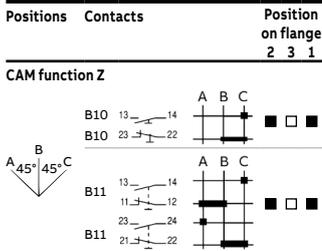

Note: dot in this diagram = contact closed.
 B10 = P9B10VN, P9B10FN contact blocks
 B01 = P9B01VN, P9B01FN contact blocks
 B11 = P9B11VN contact blocks

Description

Each reference includes the satin chrome metal body and nut together with the holder, 2 keys included.

Operating principle	Key code	Key head color	CAM function	Type	Order code	Pkg qty	Weight (1 pce) kg
<p>Key can be removed in B position only</p>	01	Metal	Z	P9MSCZ3C01	1SFA193110R9006	1	0.120
	95	Metal	Z	P9MSCZ3C95	1SFA184467R9006	1	0.120
<p>Key can be removed in A position only</p>	01	Metal	Z	P9MSCZ5A01	1SFA193020R9006	1	0.120
	95	Metal	Z	P9MSCZ5A95	1SFA184461R9006	1	0.120
<p>Key can be removed in A and B positions</p>	01	Metal	Z	P9MSCZ5H01	1SFA193050R9006	1	0.120
	95	Metal	Z	P9MSCZ5H95	1SFA184463R9006	1	0.120
<p>Key can be removed in B position only</p>	95	Metal	Z	P9MSCZ5C95	1SFA184462R9006	1	0.120

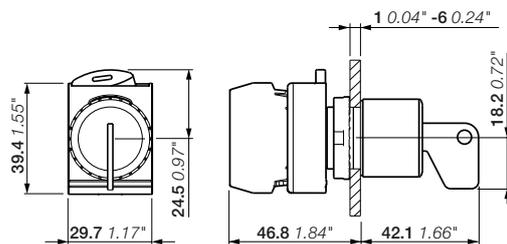

P9MSC..01, P9MSC..95
 Dimensions (mm, inches)

Modular metal range

Key-operated selector switches - 4-position



P9MSCX0A95
with holder

Description

Each reference includes the satin chrome metal body and nut together with the holder, 2 keys included.

Operating principle	Key code	Key head color	CAM function	Type	Order code	Pkg qty	Weight (1 pce) kg
	95	Metal	X	P9MSCX0A95	1SFA184468R9006	1	0.120
	Key can be removed in A position						
Key can be removed in all positions	01	Metal	X	P9MSCX0Z01	1SFA193335R9006	1	0.120
	95	Metal	X	P9MSCX0Z95	1SFA184482R9006	1	0.120

1SFC151516V0001

Electrical diagram

Positions	Contacts	Position on flange
		2 3 1

CAM function X

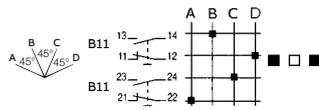

Note: dot in this diagram = contact closed.
B11 = P9B11VN contact blocks

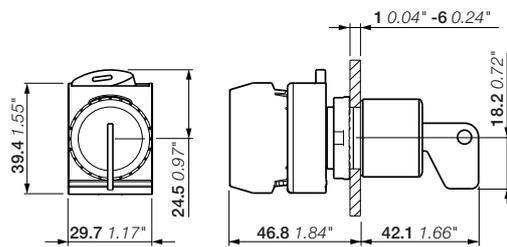

P9MSC..01, P9MSC..95
Dimensions (mm, inches)

Modular metal range

Joysticks - 2-position and 4-position



1SFC151477V0001

P9MMN2A with holder



1SFC151576V0001

P9MMB2FG

Description

Each reference includes the satin chrome metal body and nut together with the holder.

Position	Material Color	Type	Order code	Pkg qty	Weight (1 pce) kg
Without latching function					
	Rubber/Black	P9MMN2F	1SFA184700R9006	1	0.090
	Rubber/Black	P9MMN2T	1SFA184701R9006	1	0.090
	Rubber/Black	P9MMN2A	1SFA184702R9006	1	0.090
	Rubber/Black	P9MMN2B	1SFA184703R9006	1	0.090
	Rubber/Black	P9MMN4F	1SFA184720R9006	1	0.090
	Rubber/Black	P9MMN4T	1SFA184721R9006	1	0.090
	Silicone/Grey	P9MMN4TG	1SFA184716R9006	1	0.090
With latching function					
	Rubber/Black	P9MMB2F	1SFA184710R9006	1	0.090
	Silicone/Grey	P9MMB2FG	1SFA184709R9006	1	0.090
	Rubber/Black	P9MMB2T	1SFA184711R9006	1	0.090
	Rubber/Black	P9MMB2A	1SFA184712R9006	1	0.090
	Rubber/Black	P9MMB4F	1SFA184740R9006	1	0.090
	Rubber/Black	P9MMB4T	1SFA184741R9006	1	0.090
	Silicone/Grey	P9MMB4TG	1SFA184744R9006	1	0.090

Electrical diagram

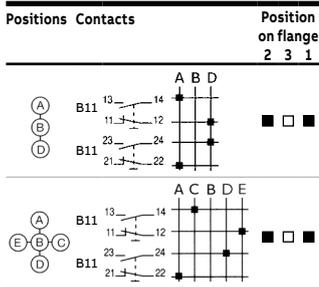

Note: dot in this diagram = contact closed.
B11= P9B11VN contact blocks

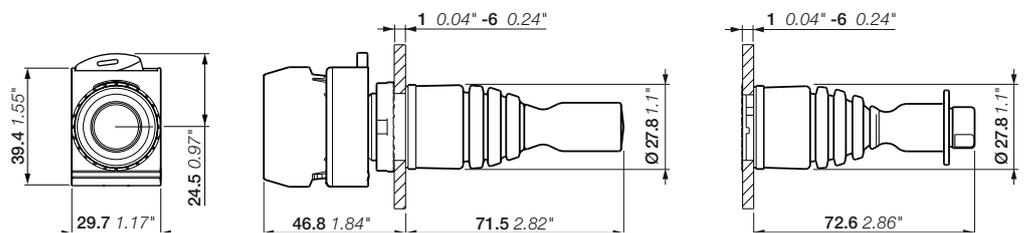

P9MMN, P9MMB
Dimensions (mm, inches)

Modular metal range

Joysticks - Accessories



15FC151435V0001

P9ARSCMN



15FC151614V0001

P9ARSCMB



15FC151434V0001

P9ARSGMN



15FC151613V0001

P9ARSGMB

Accessories

Description	Color	Type	Order code	Pkg qty	Weight (1 pce) kg
Rubber boot for joystick without latching	● Black	P9ARSCMN	1SFA188043R8000	5	0.008
Rubber boot for joystick with latching	● Black	P9ARSCMB	1SFA188044R8000	5	0.008
Silicone boot for joystick without latching	● Grey	P9ARSGMN	1SFA187495R8000	5	0.008
Silicone boot for joystick with latching	● Grey	P9ARSGMB	1SFA187496R8000	5	0.008

Modular metal range

Toggle switches



1SFA184690001

P9MCD with holder

Description

Each reference includes the satin chrome metal body and nut together with the holder.

Operating principle	CAM function	Type	Order code	Pkg qty	Weight (1 pce) kg
2 position					
	D	P9MCD	1SFA184695R9006	1	0.073
3 position					
	B	P9MCB	1SFA184696R9006	1	0.073
	B	P9MCC	1SFA184697R9006	1	0.073

Contacts actuated

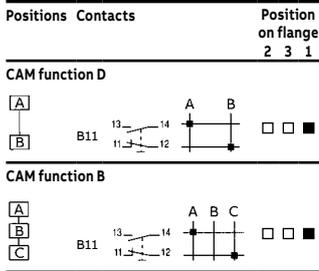

B11 = P9B11VN contact blocks

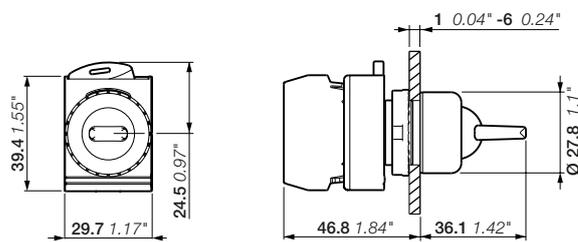

P9MC
Dimensions (mm, inches)

Modular metal range

Selector pushbuttons



1SFC151474V0001

P9MPS22G with holder

Description

Each reference includes the satin chrome metal body and nut together with the holder.

Operating principle	CAM function	Type	Order code	Pkg qty	Weight (1 pce) kg
2 position					
	231	P9MPS22G	1SFA184691R9006	1	0.069
3 position					
	301	P9MPS34G	1SFA184693R9006	1	0.065

Electrical diagram

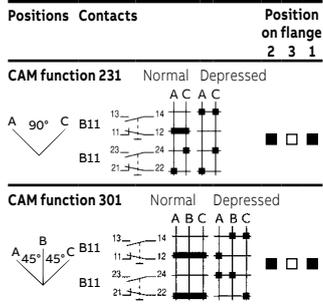

Note: dot in this diagram = contact closed.
B11 = P9B11VN contact blocks

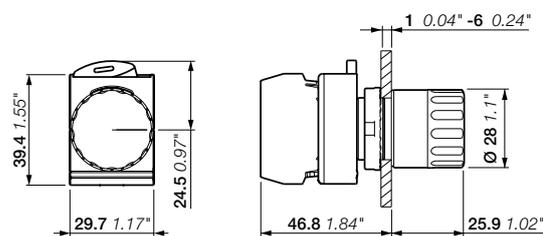

P9MPS
Dimensions (mm, inches)

Modular metal range

Holders and contact blocks for front mounting



1SFC151627V0001

P9ACFS3



1SFC151626V0001

P9ACFS5



1SFC151611V0001

P9B10VN



1SFC15160V0001

P9B20VN



1SFC151611V0001

P9B10VA



1SFC151612V0001

P9B10FN

Screw terminals

Description	Contacts	Type	Order code	Pkg qty	Weight (1 pce)
					kg

Holders

3-position	- -	P9ACFS3	1SFA187841R8000	1	0.009
5-position	- -	P9ACFS5	1SFA187842R8000	1	0.016

Single contact blocks

For 3 & 5-position holder	1 0	P9B10VN	1SFA187002R8001	1	0.009
	1 0	P9B10VN-AA	1SFA215832R8001	200	0.009
	0 1	P9B01VN	1SFA187001R8010	1	0.009

Double contact blocks

For 3 & 5-position holder	2 0	P9B20VN	1SFA187009R8002	1	0.016
	0 2	P9B02VN	1SFA187008R8020	1	0.016
	0 2	P9B02VN-AA	1SFA205236R8020	200	0.016
	1 1	P9B11VN	1SFA187000R8011	1	0.016
	1 1	P9B11VN-AA	1SFA242712R8011	500	0.016

Single contact blocks with N.O. early make contacts and N.C. late break contacts

For 3 & 5-position holder	1 0	P9B10VA	1SFA187004R8201	1	0.009
	0 1	P9B01VR	1SFA187003R8110	1	0.010

Faston terminals

Single contact blocks (1)

For 3 & 5-position holder	1 0	P9B10FN	1SFA187013R8301	1	0.009
	1 0	P9B10FN-AA	1SFA215835R8301	200	0.009
	0 1	P9B01FN	1SFA187012R8310	1	0.009

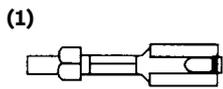

1x (6.35 x 0.8 mm)
2x (2.8 x 0.8 mm)

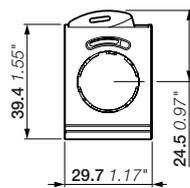

P9ACFS3

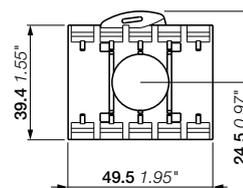
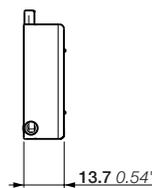

P9ACFS5

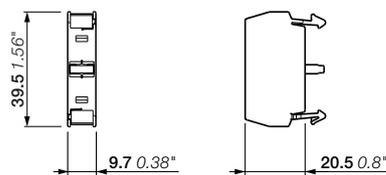
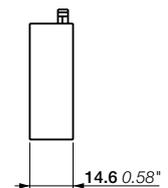

P9B10VN, P9B01VN, P9B10VA, P9B01VR

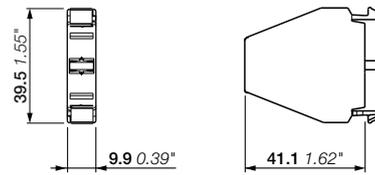

P9B20VN, P9B02VN, P9B11VN

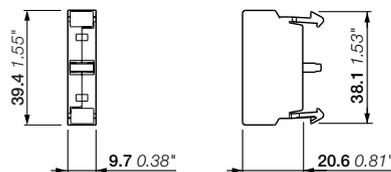

P9B10FN, P9B01FN

Dimensions (mm, inches)

Modular metal range

Power supplies



P9PDNV0



P9PDTV0



P9PDNF0

Description	Type	Order code	Pkg qty	Weight (1 pce) kg
Screw terminals				
Full voltage	P9PDNV0	1SFA187020R1080	1	0.010
IEC: BA9S max 380 V - 2 W bulb not included	P9PDNV0-AA	1SFA215831R1000	100	0.010
UL - CSA: BA9S max 250 V - 2 W bulb not included				
Test full voltage	P9PDTV0	1SFA187027R8000	1	0.018
IEC: BA9S max 380 V - 2 W bulb not included				
UL - CSA: BA9S max 250 V - 2 W bulb not included				
Note: P9PDTV0 are not included in UL listing.				
Faston terminals				
Full voltage	P9PDNF0	1SFA187055R1300	1	0.013
IEC: BA9S max 380 V - 2 W bulbs not included	P9PDNF0-AA	1SFA215834R1300	100	0.013
UL - CSA: BA9S max 250 V... - 2 W bulbs not included				

Contacts actuated

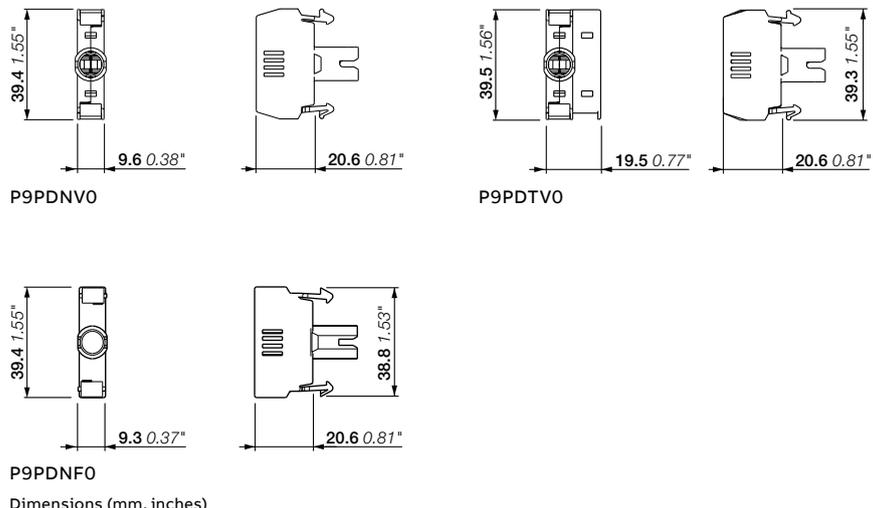
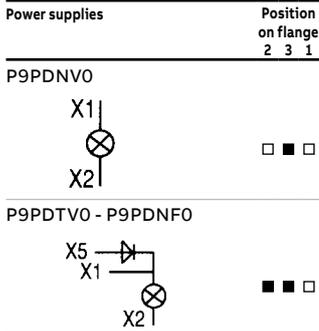

Modular metal range

LED bulbs for power supplies



BA9S6LEDB

15FC151630V0001

Color	Type	Order code	Pkg qty	Weight (1 pce) kg
Rated voltage 6 V AC/DC				
● Red	BA9S6LEDR	1SFA187163R1001	5	0.002
● Green	BA9S6LEDV	1SFA187164R1002	5	0.002
● Yellow	BA9S6LEDG	1SFA187161R1003	5	0.002
● Blue	BA9S6LEDL	1SFA187162R1004	5	0.002
○ White	BA9S6LEDB	1SFA187160R1005	5	0.002
Rated voltage 12 V AC/DC				
● Red	BA9S12LEDR	1SFA187168R1011	5	0.002
● Green	BA9S12LEDV	1SFA187169R1012	5	0.002
● Yellow	BA9S12LEDG	1SFA187166R1013	5	0.002
● Blue	BA9S12LEDL	1SFA187167R1014	5	0.002
○ White	BA9S12LEDB	1SFA187165R1015	5	0.002
Rated voltage 24 V AC/DC				
● Red	BA9S24LEDR	1SFA187173R1021	5	0.002
● Green	BA9S24LEDV	1SFA187174R1022	5	0.002
● Yellow	BA9S24LEDG	1SFA187171R1023	5	0.002
● Blue	BA9S24LEDL	1SFA187172R1024	5	0.002
○ White	BA9S24LEDB	1SFA187170R1025	5	0.002
Rated voltage 48 V AC/DC				
● Red	BA9S48LEDR	1SFA187178R1031	5	0.002
● Green	BA9S48LEDV	1SFA187179R1032	5	0.002
● Yellow	BA9S48LEDG	1SFA187176R1033	5	0.002
● Blue	BA9S48LEDL	1SFA187177R1034	5	0.002
○ White	BA9S48LEDB	1SFA187175R1035	5	0.002
Rated voltage 60 V AC/DC				
○ White	BA9S60LED	1SFA187191R1045	5	0.002
Rated voltage 110 - 120 V AC/DC				
● Red	BA9S110LEDR	1SFA187183R1041	5	0.002
● Green	BA9S110LEDV	1SFA187184R1042	5	0.002
● Yellow	BA9S110LEDG	1SFA187181R1043	5	0.002
● Blue	BA9S110LEDL	1SFA187182R1044	5	0.002
○ White	BA9S110LEDB	1SFA187180R1045	5	0.002
Rated voltage 130 V AC/DC				
○ White	BA9S130LED	1SFA187190R1045	5	0.002
Rated voltage 230 V AC				
● Red	BA9S230LEDR	1SFA187188R1051	5	0.002
● Green	BA9S230LEDV	1SFA187189R1052	5	0.002
● Yellow	BA9S230LEDG	1SFA187186R1053	5	0.002
● Blue	BA9S230LEDL	1SFA187187R1054	5	0.002
○ White	BA9S230LEDB	1SFA187185R1055	5	0.002

Modular metal range

LED blocks for front mouting



P9PLNVDR

1SFC151499W0001

Standard Light

Color	Type	Order code	Pkg qty	Weight (1 pce) kg
Rated voltage 24 V AC/DC				
● Red	P9PLNVDR	1SFA197004R1011	1	0.020
● Green	P9PLNVDV	1SFA197005R1012	1	0.020
● Yellow	P9PLNVDG	1SFA197002R1013	1	0.020
● Blue	P9PLNVDL	1SFA197003R1014	1	0.020
○ White	P9PLNVDB	1SFA197001R1015	1	0.020

Rated voltage 120 V AC

● Red	P9PLNVJR	1SFA197010R1041	1	0.020
● Green	P9PLNVJV	1SFA197011R1042	1	0.020
● Yellow	P9PLNVJG	1SFA197008R1043	1	0.020
● Blue	P9PLNVJL	1SFA197009R1044	1	0.020
○ White	P9PLNVJB	1SFA197007R1045	1	0.020

Rated voltage 230 V AC

● Red	P9PLNVNR	1SFA197016R1071	1	0.020
● Green	P9PLNVNV	1SFA197017R1072	1	0.020
● Yellow	P9PLNVNG	1SFA197014R1073	1	0.020
● Blue	P9PLNVNL	1SFA197015R1074	1	0.020
○ White	P9PLNVNB	1SFA197013R1075	1	0.020

Flashing Light

Color	Type	Order code	Pkg qty	Weight (1 pce) kg
Rated voltage 24 V AC/DC				
● Red	P9PLFVDR	1SFA197022R1011	1	0.020
● Green	P9PLFVDV	1SFA197023R1012	1	0.020
● Yellow	P9PLFVDG	1SFA197020R1013	1	0.020
● Blue	P9PLFVDL	1SFA197021R1014	1	0.020
○ White	P9PLFVDB	1SFA197019R1015	1	0.020
● Orange	P9PLFVDA	1SFA197018R1019	1	0.020

Rated voltage 120 V AC

● Red	P9PLFVJR	1SFA197028R1041	1	0.020
● Yellow	P9PLFVJG	1SFA197026R1043	1	0.020
○ White	P9PLFVJB	1SFA197025R1045	1	0.020

Rated voltage 230 V AC

● Red	P9PLFVNR	1SFA197034R1071	1	0.020
● Yellow	P9PLFVNG	1SFA197032R1073	1	0.020
○ White	P9PLFVNB	1SFA197031R1075	1	0.020

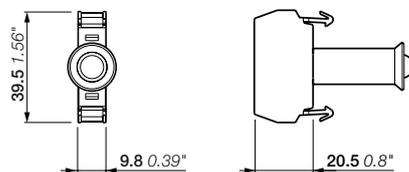

P9PL

Dimensions (mm, inches)

Modular metal range

Accessories



P9ACRCL

15FC151463V0001



P9ACDPP

15FC151628V0001



P9ACWAF

15FC151629V0001



P9ARAM32

15FC151464V0001



P9ACA6

15FC151462V0001



080CPR

15FC151460V0001



080CPN

15FC151461V0001



P9ARCST

15FC151465V0001

Description	Contacts	Type	Order code	Pkg qty	Weight (1 pce)
					kg
Protection cover					
Protection cover padlockable for standard pushbuttons, illuminated pushbuttons, selector switches, illuminated selector switches		P9ACRCL	1SFA187840R8000	1	0.039
Maintained accessory					
Device for standard pushbuttons, illuminated pushbuttons: To be used only with contact blocks P9B01VN, P9B01VR, P9B10VA and P9B01FN		P9ACDPP	1SFA187843R8000	1	0.012
Tools					
Locking ring wrench		P9ACWAF	1SFA187845R8000	1	0.037
Adapter ring					
Adapter ring for 30 mm hole to mount P9 22 mm in a 30 mm hole		P9ARAM32	1SFA188801R8000	5	0.006
Terminal adapter					
PCB adapter for faston contacts		P9ACA6	1SFA188804R8000	5	0.051

Rubber protective caps (IP66) for standard pushbuttons

Flush pushbuttons

Description	Type	Order code	Pkg qty	Weight (1 pce)
nutrilic rubber				kg
● Red	080CPR	1SFA170191R8000	5	0.004
● Green	080CPV	1SFA170192R8000	5	0.004
● Black	080CPN	1SFA170190R8000	5	0.004
○ Clear	080CPT	1SFA170198R8000	5	0.004

Extended pushbuttons

○ Clear	P9ARCST	1SFA187490R8000	5	0.004
---------	---------	-----------------	---	-------

Modular metal range

Metal enclosures with holes and accessories



080SP8



080SP12



080SP18



080SP24

Enclosure with holes for pilot devices

Empty enclosures in aluminium, IP66. Grey color.

Description	Hole types	Type	Order code	Pkg qty	Weight (1 pce) kg
With hole for cable gland					
1-seat	1	080SP1	1SFA170801R1001	1	0.313
2-seat	2	080SP2	1SFA170802R1002	1	0.440
3-seat	3	080SP3	1SFA170803R1003	1	0.695
4-seat	4	080SP4	1SFA170804R1004	1	0.435
6-seat	6	080SP6	1SFA170806R1006	1	0.694
8-seat	8	080SP8	1SFA170807R1008	1	0.932
12-seat	12	080SP12	1SFA170808R1012	1	1.685
18-seat	18	080SP18	1SFA170809R1018	1	2.891
24-seat	24	080SP24	1SFA170810R1024	1	2.912
With hole for cable gland and deep base					
1-seat	1M	080SP1M	1SFA170831R1001	1	0.402
2-seat	2M	080SP2M	1SFA170832R1002	1	0.540
4-seat	4M	080SP4M	1SFA170834R1004	1	0.530
Without hole for cable gland					
1-seat	1	080SP1SFE	1SFA170836R3001	1	0.335
2-seat	2	080SP2SFE	1SFA170842R3002	1	0.442
3-seat	3	080SP3SFE	1SFA170848R3003	1	0.715
4-seat	4	080SP4SFE	1SFA170850R3004	1	0.453
6-seat	6	080SP6SFE	1SFA170852R3006	1	0.705
8-seat	8	080SP8SFE	1SFA170854R3008	1	0.990
12-seat	12	080SP12SFE	1SFA170857R3012	1	1.737
Without hole for cable gland and deep base					
1-seat	1M	080SP1MSFE	1SFA170839R3001	1	0.416

Modular metal range

Metal enclosures without holes



080SP1SFC

1SFCL51642V0001



080SP3SFC

1SFCL51634V0001



080SP8SF

1SFCL51482V0001

Enclosure without holes for pilot devices

Empty enclosures in aluminium, IP66. Grey color.

Description	Size type	Type	Order code	Pkg qty	Weight (1 pce) kg
With hole for cable gland					
	1	080SP1SFC	1SFA170835R2000	1	0.324
	2	080SP2SFC	1SFA170841R2000	1	0.444
	3	080SP3SFC	1SFA170847R2000	1	0.708
	8	080SP8SFC	1SFA170853R2000	1	0.977
	12	080SP12SFC	1SFA170856R2000	1	1.720
	18	080SP18SFC	1SFA170859R2000	1	2.948
With hole for cable gland and deep base					
	1M	080SP1MSFC	1SFA170838R2000	1	0.405
	2M	080SP2MSFC	1SFA170844R2000	1	0.542
Without hole for cable gland					
	1	080SP1SF	1SFA170837R4000	1	0.333
	2	080SP2SF	1SFA170843R4000	1	0.446
	3	080SP3SF	1SFA170849R4000	1	0.735
	8	080SP8SF	1SFA170855R4000	1	1.019
	12	080SP12SF	1SFA170858R4000	1	1.775
	18	080SP18SF	1SFA170861R4000	1	3.050
Without hole for cable gland and deep base					
	1M	080SP1MSF	1SFA170840R4000	1	0.414
	2M	080SP2MSF	1SFA170846R4000	1	0.553

Modular metal range

Technical data

Standards and approvals

IEC / EN 60947-1	Low Voltage switchgear and controlgear - Part 1: General rules
IEC / EN 60947-5-1	Low Voltage switchgear and controlgear - part 5-1: control circuit devices and switching elements - Electromechanical control circuit devices
IEC / EN 60073	Basic and safety principles for man-machine interface, marking and identification coding principles for indicators and actuators
IEC / EN 60529	Degrees of protection provided by enclosures (IP code)
UL 508	Industrial control equipment
CSA C22.2 No 14	Industrial control equipment

Environmental data

Degrees of protection

Operators	IEC/EN DIN	UL/CSA
Modular metal range: P9M	IP66	Type 1, 3, 3R, 3S, 4, 4X, 12, 13
Contact block: P9B	IP2x	-
Metallic enclosures: 080SP	IP66, IP69K	-
For size 080SP1, 1M, 2, 2M, 3, 4, 4M or 6	IP66, IP69K	Type 1, 3, 3R, 3S, 4, 4X, 12, 13

Connecting capacity

	Solid/stranded	1 x 0.75...2.5 mm ²
		2 x 0.75...2.5 mm ²
	Flexible	1 x 0.75...2.5 mm ²
		2 x 0.75...2.5 mm ²
	Flexible with non insulated ferrule	1 x 0.75...2.5 mm ²
		2 x 0.75...2.5 mm ²
	Flexible with insulated ferrule	1 x 0.75...2.5 mm ²
		2 x 0.75...2.5 mm ²
	Lugs	L < 7.0 mm l > 3.5 mm
Connection capacity acc. to UL / CSA		AWG 18...14
Stripping length		10 mm

Tightening torques

Cable terminals M3.5	0.9 Nm
Recommended screwdriver for cable terminal	Pozidriv 2
Operators locking nut	Min. 2 Nm / Max. 2.3 Nm

Electrical data

P9B Standard contact blocks

Self cleaning silver contacts, NC contact with positive opening.

Ratings as per IEC 60947-5-1

Rated insulation voltage, U _i	690 V	
Rated thermal current, I _{th}	10 A	
Rated operational current, I _e	at: 24 V	10 A
	at: 48 V	10 A
Utilization category AC 15,	at: 60 V	10 A
	at: 110 V	6 A
	at: 220V	3 A
	at: 380 V	2 A
	at: 500 V	1.5 A
	at: 600 V	1.2 A
Rated operational current, I _e utilisation category DC 13,	at: 24 V	2.5 A
	at: 48 V	1.4 A
	at: 60 V	1 A
	at: 110 V	0.55 A
	at: 220V	0.27 A
	at: 300 V	0.2 A
Rated impulse withstand voltage	U _{imp}	4 kV
Rated frequency	50/60 Hz	

Performances according to CSA and UL

AC heavy duty	(A600)
DC standard duty	(Q300)

Number of electrical contacts

Holder	Standard 3 positions	Optional 5 positions
Momentary pushbuttons		
Momentray mushroom pushbuttons	Max 6	Max 8
Standard selector switches		
Key selector switches	Max 4	Max 8
Joysticks		
Selector pushbuttons	Max 4	-
Toggle switches		
Maintained mushroom pushbuttons	Max 4	-
Illuminated pushbuttons		
Illuminated momentary mushroom pushbuttons	Max 4	Max 4
Illuminated selector switches		
Illuminated maintained mushroom pushbuttons	Max 2	Max 2

Short circuit protection

With fuses 16 A gG acc. to IEC 60269-1 and IEC 60269-3

Minimum switching capacity

Standard contact blocks	12 V DC	5 mA
-------------------------	---------	------

Modular metal range

Technical data

Mechanical endurance

Joysticks	500 000 operations
Key pushbuttons	500 000 operations
Toggle switches	
Illuminated selector switches	
Maintained accessory	
Standard selector switches	1 million operations
Key selector switches	1 million operations
Illuminated pushbuttons	
Selector pushbuttons	
Standard pushbuttons	3 million operations
Mushroom head pushbuttons	3 million operations

Performances of the contacts

- Slow acting
- Self-cleaning sliding
- NC forced breaking
- Double movable bridge
- Four switching points
- Double break

Identification of the terminals

According to EN 50013

Electrical endurance

Alternative current 50/60Hz cat. AC 15

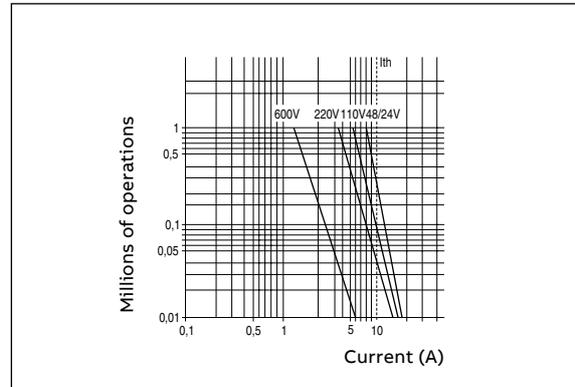

Direct current cat. DC 13

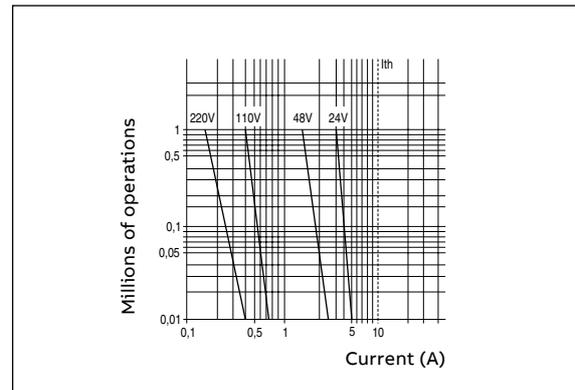

Rear panel modularity

The P9 series is composed with 10 mm or a multiple of 10 mm modular units, fitted side by side on a proper mounting flange.

The standard operators are supplied with a three position flange with a capacity of 3 units of 10 mm or 1 of 10 mm and 1 of 20 mm or 1 of 30 mm.

When the three position flange is not enough to satisfy the applications needs, the five position flange is required to add two more units of 10 mm mounted side by side.

Using the five position flange take into account the bigger width (50 mm instead of 30 mm).

Modular metal range

Dimension

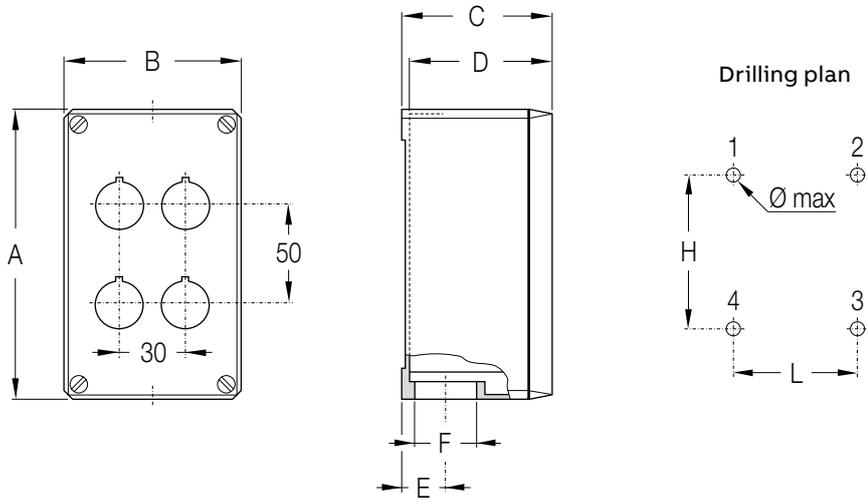

Size type	Holes Ø 22		Dimensions										Drilling plan			
	Vertic.	Horizont.	A		B		C		D		E		F	H x L x Ø max		Position of the holes
			mm	in	mm	in	mm	in	mm	in	mm	in		mm	in	
1	1	-	87	3.43	87	3.43	75	2.95	72	2.83	21.5	0.85	PG 21	74x55x4	2.91x2.17x0.16	1-3
1M	1	-	87	3.43	87	3.43	100	3.94	97	3.82	21.5	0.85	PG 21	68x55x4	2.68x2.17x0.16	1-3
2	2	-	145	5.71	87	3.43	75	2.95	72	2.83	21.5	0.85	PG 21	132x55x4	5.2x2.17x0.16	1-3
2M	2	-	145	5.71	87	3.43	100	3.94	97	3.82	21.5	0.85	PG 21	126x55x4	4.96x2.17x0.16	1-3
3	3	-	195	7.68	87	3.43	100	3.94	97	3.82	21.5	0.85	PG 21	176x55x4	6.93x2.17x0.16	1-3
4	2	2	145	5.71	87	3.43	75	2.95	72	2.83	21.5	0.85	PG 21	132x55x4	5.2x2.17x0.16	1-3
4M	2	2	145	5.71	87	3.43	100	3.94	97	3.82	21.5	0.85	PG 21	126x55x4	4.96x2.17x0.16	1-3
6	3	2	195	7.68	87	3.43	100	3.94	97	3.82	21.5	0.85	PG 21	176x55x4	6.93x2.17x0.16	1-3
8	2	4	152	5.98	152	5.98	101.5	4	98.5	3.88	27	1.06	PG 29	136x119x6	5.35x4.69x0.24	1-2-3-4
12	3	4	205	8.07	230	9.06	101.5	4	98.5	3.88	27	1.06	PG 29	172x214x6	6.77x8.43x0.24	1-2-3-4
18	3	6	257	10.12	300	11.81	101.5	4	98.5	3.88	35	1.38	PG 36	221x282x6	8.7x11.1x0.24	1-2-3-4
24	4	6	257	10.12	300	11.81	101.5	4	98.5	3.88	35	1.38	PG 36	221x282x6	8.7x11.1x0.24	1-2-3-4

Modular metal range

Drilling plan

Mounting

Fitted for panels 1 to 6 mm thick with holes drilled according to IEC60947-5-1 standard.

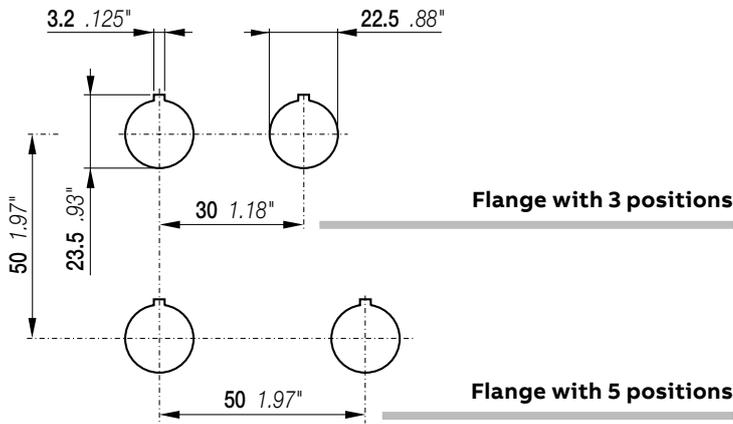

03

Pilot devices, 22 mm

Compact range

Ordering details

91	Non-illuminated flush pushbuttons
93	Non-illuminated extended pushbuttons
95	Illuminated flush pushbuttons
97	Illuminated extended pushbuttons
99	Non-illuminated mushroom pushbuttons
100	Non-illuminated emergency stop pushbuttons
101	Non-illuminated machine stop pushbuttons
102	Heavy duty pushbuttons
103	Pilot lights
106	LED bulbs for CL-100 pilot lights
107	Non-illuminated selector switches
109	Buzzers

110 Accessories

112 Technical data

118 Drilling plan

Compact range

The compact range is the most efficient solution reducing both installation time and cost thanks to the all-in-one design. It is perfect for tough environment thanks to the market leading level of dust and water resistance.

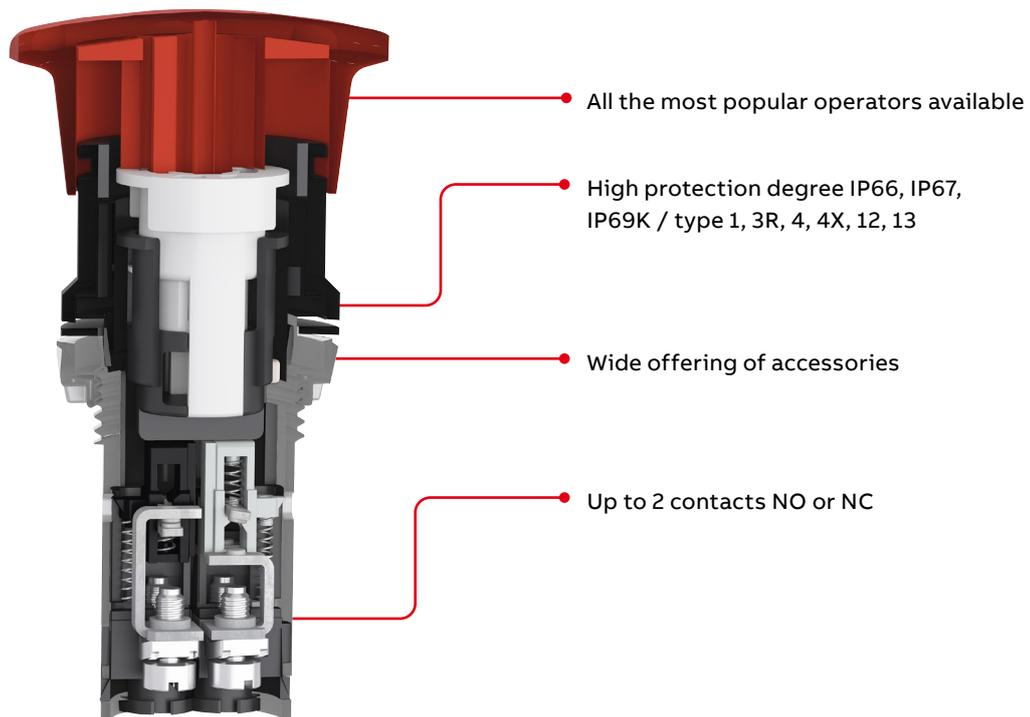

Compact range

Non-illuminated flush pushbuttons - Momentary



Operator	Bezel	Contacts	Type	Order code	Pkg qty	Weight (1 pce)		
						kg		
● Red	Black plastic	10	CP1-10R-10	1SFA619100R1011	10	0.018		
		01	CP1-10R-01	1SFA619100R1041	10	0.018		
		11	CP1-10R-11	1SFA619100R1071	10	0.022		
		20	CP1-10R-20	1SFA619100R1021	10	0.022		
		02	CP1-10R-02	1SFA619100R1051	10	0.022		
		10	CP1-30R-10	1SFA619100R3011	10	0.032		
	Chrome metal	01	CP1-30R-01	1SFA619100R3041	10	0.032		
		11	CP1-30R-11	1SFA619100R3071	10	0.036		
		20	CP1-30R-20	1SFA619100R3021	10	0.036		
		02	CP1-30R-02	1SFA619100R3051	10	0.036		
		● Green	Black plastic	10	CP1-10G-10	1SFA619100R1012	10	0.018
				11	CP1-10G-11	1SFA619100R1072	10	0.022
20	CP1-10G-20			1SFA619100R1022	10	0.022		
Chrome metal	10		CP1-30G-10	1SFA619100R3012	10	0.032		
	11		CP1-30G-11	1SFA619100R3072	10	0.036		
	20		CP1-30G-20	1SFA619100R3022	10	0.036		
● Yellow	Black plastic	10	CP1-10Y-10	1SFA619100R1013	10	0.018		
		11	CP1-10Y-11	1SFA619100R1073	10	0.022		
		20	CP1-10Y-20	1SFA619100R1023	10	0.022		
	Chrome metal	10	CP1-30Y-10	1SFA619100R3013	10	0.032		
		11	CP1-30Y-11	1SFA619100R3073	10	0.036		
		20	CP1-30Y-20	1SFA619100R3023	10	0.036		
● Blue	Black plastic	10	CP1-10L-10	1SFA619100R1014	10	0.018		
		11	CP1-10L-11	1SFA619100R1074	10	0.022		
		20	CP1-10L-20	1SFA619100R1024	10	0.022		
	Chrome metal	10	CP1-30L-10	1SFA619100R3014	10	0.032		
		11	CP1-30L-11	1SFA619100R3074	10	0.036		
		20	CP1-30L-20	1SFA619100R3024	10	0.036		
○ White	Black plastic	10	CP1-10W-10	1SFA619100R1015	10	0.018		
		11	CP1-10W-11	1SFA619100R1075	10	0.022		
		20	CP1-10W-20	1SFA619100R1025	10	0.022		
	Chrome metal	10	CP1-30W-10	1SFA619100R3015	10	0.032		
		11	CP1-30W-11	1SFA619100R3075	10	0.036		
		20	CP1-30W-20	1SFA619100R3025	10	0.036		
● Black	Black plastic	10	CP1-10B-10	1SFA619100R1016	10	0.018		
		01	CP1-10B-01	1SFA619100R1046	10	0.018		
		11	CP1-10B-11	1SFA619100R1076	10	0.022		
		20	CP1-10B-20	1SFA619100R1026	10	0.022		
		02	CP1-10B-02	1SFA619100R1056	10	0.022		
		10	CP1-30B-10	1SFA619100R3016	10	0.032		
	Chrome metal	01	CP1-30B-01	1SFA619100R3046	10	0.032		
		11	CP1-30B-11	1SFA619100R3076	10	0.036		
		20	CP1-30B-20	1SFA619100R3026	10	0.036		
		02	CP1-30B-02	1SFA619100R3056	10	0.036		

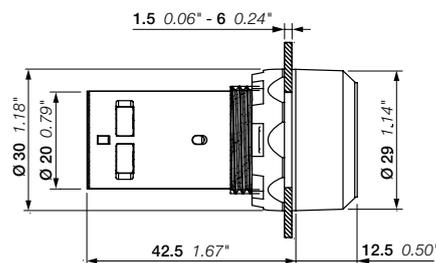

CP1
Dimensions (mm, inches)

Compact range

Non-illuminated flush pushbuttons - Maintained



Operator	Bezel	Contacts	Type	Order code	Pkg qty	Weight (1 pce)
						kg
● Red	Black plastic	1 0	CP2-10R-10	1SFA619101R1011	10	0.018
		0 1	CP2-10R-01	1SFA619101R1041	10	0.018
		1 1	CP2-10R-11	1SFA619101R1071	10	0.022
		2 0	CP2-10R-20	1SFA619101R1021	10	0.022
		0 2	CP2-10R-02	1SFA619101R1051	10	0.022
		1 0	CP2-30R-10	1SFA619101R3011	10	0.032
● Green	Chrome metal	0 1	CP2-30R-01	1SFA619101R3041	10	0.032
		1 1	CP2-30R-11	1SFA619101R3071	10	0.036
		2 0	CP2-30R-20	1SFA619101R3021	10	0.036
		0 2	CP2-30R-02	1SFA619101R3051	10	0.036
		1 0	CP2-10G-10	1SFA619101R1012	10	0.018
		1 1	CP2-10G-11	1SFA619101R1072	10	0.022
● Yellow	Black plastic	2 0	CP2-10G-20	1SFA619101R1022	10	0.022
		1 0	CP2-30G-10	1SFA619101R3012	10	0.032
		1 1	CP2-30G-11	1SFA619101R3072	10	0.036
		2 0	CP2-30G-20	1SFA619101R3022	10	0.036
		1 0	CP2-10Y-10	1SFA619101R1013	10	0.018
		1 1	CP2-10Y-11	1SFA619101R1073	10	0.022
● Blue	Chrome metal	2 0	CP2-10Y-20	1SFA619101R1023	10	0.022
		1 1	CP2-30Y-11	1SFA619101R3073	10	0.036
		2 0	CP2-30Y-20	1SFA619101R3023	10	0.036
		1 0	CP2-10L-10	1SFA619101R1014	10	0.018
		1 1	CP2-10L-11	1SFA619101R1074	10	0.022
		2 0	CP2-10L-20	1SFA619101R1024	10	0.022
○ White	Black plastic	1 0	CP2-30L-10	1SFA619101R3014	10	0.032
		2 0	CP2-30L-20	1SFA619101R3024	10	0.036
		1 0	CP2-10W-10	1SFA619101R1015	10	0.018
		1 1	CP2-10W-11	1SFA619101R1075	10	0.022
		2 0	CP2-10W-20	1SFA619101R1025	10	0.022
		1 0	CP2-30W-10	1SFA619101R3015	10	0.032
● Black	Chrome metal	2 0	CP2-30W-20	1SFA619101R3025	10	0.036
		1 0	CP2-10B-10	1SFA619101R1016	10	0.018
		0 1	CP2-10B-01	1SFA619101R1046	10	0.018
		1 1	CP2-10B-11	1SFA619101R1076	10	0.022
		2 0	CP2-10B-20	1SFA619101R1026	10	0.022
		0 2	CP2-10B-02	1SFA619101R1056	10	0.022
	Black plastic	1 0	CP2-30B-10	1SFA619101R3016	10	0.032
		0 1	CP2-30B-01	1SFA619101R3046	10	0.032
		1 1	CP2-30B-11	1SFA619101R3076	10	0.036
		2 0	CP2-30B-20	1SFA619101R3026	10	0.036

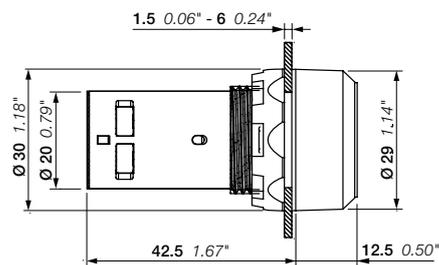

CP2
Dimensions (mm, inches)

Compact range

Non-illuminated extended pushbuttons - Momentary



Operator	Bezel	Contacts	Type	Order code	Pkg qty	Weight (1 pce)	
						kg	
● Red	Black plastic	10	CP3-10R-10	1SFA619102R1011	10	0.019	
		01	CP3-10R-01	1SFA619102R1041	10	0.019	
		11	CP3-10R-11	1SFA619102R1071	10	0.022	
	Chrome metal	20	CP3-10R-20	1SFA619102R1021	10	0.022	
		02	CP3-10R-02	1SFA619102R1051	10	0.022	
		01	CP3-30R-01	1SFA619102R3041	10	0.033	
● Green	Black plastic	11	CP3-30R-11	1SFA619102R3071	10	0.036	
		20	CP3-30R-20	1SFA619102R3021	10	0.036	
		10	CP3-10G-10	1SFA619102R1012	10	0.019	
	Chrome metal	11	CP3-10G-11	1SFA619102R1072	10	0.022	
		20	CP3-10G-20	1SFA619102R1022	10	0.022	
		10	CP3-30G-10	1SFA619102R3012	10	0.033	
● Yellow	Black plastic	11	CP3-30G-11	1SFA619102R3072	10	0.036	
		20	CP3-30G-20	1SFA619102R3022	10	0.036	
		10	CP3-10Y-10	1SFA619102R1013	10	0.019	
	Chrome metal	11	CP3-10Y-11	1SFA619102R1073	10	0.022	
		20	CP3-10Y-20	1SFA619102R1023	10	0.022	
		20	CP3-30Y-20	1SFA619102R3023	10	0.036	
● Blue	Black plastic	10	CP3-10L-10	1SFA619102R1014	10	0.019	
		11	CP3-10L-11	1SFA619102R1074	10	0.022	
		20	CP3-10L-20	1SFA619102R1024	10	0.022	
	Chrome metal	20	CP3-30L-20	1SFA619102R3024	10	0.036	
		10	CP3-10W-10	1SFA619102R1015	10	0.019	
		11	CP3-10W-11	1SFA619102R1075	10	0.022	
○ White	Black plastic	20	CP3-10W-20	1SFA619102R1025	10	0.022	
		10	CP3-30W-10	1SFA619102R3015	10	0.033	
		11	CP3-30W-11	1SFA619102R3075	10	0.036	
	Chrome metal	20	CP3-30W-20	1SFA619102R3025	10	0.036	
		10	CP3-10B-10	1SFA619102R1016	10	0.019	
		01	CP3-10B-01	1SFA619102R1046	10	0.019	
● Black	Black plastic	11	CP3-10B-11	1SFA619102R1076	10	0.022	
		20	CP3-10B-20	1SFA619102R1026	10	0.022	
		02	CP3-10B-02	1SFA619102R1056	10	0.022	
	Chrome metal	10	CP3-30B-10	1SFA619102R3016	10	0.033	
		01	CP3-30B-01	1SFA619102R3046	10	0.033	
		11	CP3-30B-11	1SFA619102R3076	10	0.036	
			20	CP3-30B-20	1SFA619102R3026	10	0.036

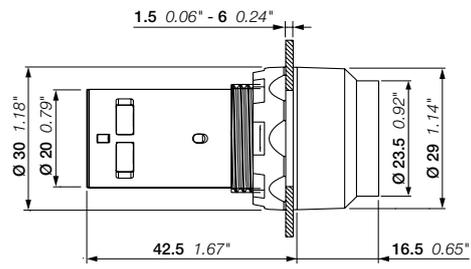

CP3
Dimensions (mm, inches)

Compact range

Non-illuminated extended pushbuttons - Maintained



Operator	Bezel	Contacts	Type	Order code	Pkg qty	Weight (1 pce)
						kg
● Red	Black plastic		CP4-10R-10	1SFA619103R1011	10	0.019
			CP4-10R-01	1SFA619103R1041	10	0.019
			CP4-10R-11	1SFA619103R1071	10	0.022
			CP4-10R-20	1SFA619103R1021	10	0.022
			CP4-10R-02	1SFA619103R1051	10	0.022
● Green	Black plastic		CP4-30R-11	1SFA619103R3071	10	0.036
			CP4-10G-10	1SFA619103R1012	10	0.019
			CP4-10G-11	1SFA619103R1072	10	0.022
			CP4-10G-20	1SFA619103R1022	10	0.022
			CP4-10G-02	1SFA619103R3012	10	0.033
● Yellow	Black plastic		CP4-30G-10	1SFA619103R3012	10	0.033
			CP4-30G-20	1SFA619103R3022	10	0.036
● Blue	Black plastic		CP4-10Y-10	1SFA619103R1013	10	0.019
			CP4-10Y-11	1SFA619103R1073	10	0.022
○ White	Black plastic		CP4-10L-10	1SFA619103R1014	10	0.019
			CP4-10L-11	1SFA619103R1074	10	0.022
● Black	Black plastic		CP4-10W-10	1SFA619103R1015	10	0.019
			CP4-10W-11	1SFA619103R1075	10	0.022
			CP4-10B-10	1SFA619103R1016	10	0.019
			CP4-10B-11	1SFA619103R1076	10	0.022
			CP4-10B-20	1SFA619103R1026	10	0.022
			CP4-10B-02	1SFA619103R1056	10	0.022

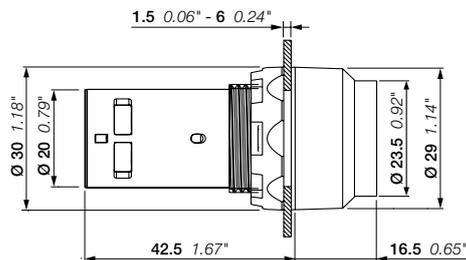

CP4
Dimensions (mm, inches)

Compact range

Illuminated flush pushbuttons - Momentary



CP1-11R-10

1SFCL5115V0001



CP1-11G-10

1SFCL51188V0001



CP1-31Y-10

1SFCL51189V0001



CP1-11L-10

1SFCL51149V0001



CP1-31C-10

1SFCL51175V0001

Operator	Bezel	Contacts	Type	Order code	Pkg qty	Weight (1 pce)
						kg



Rated voltage 24 V AC / DC

● Red	Black plastic	1 0	CP1-11R-10	1SFA619100R1111	10	0.025
		0 1	CP1-11R-01	1SFA619100R1141	10	0.025
	Chrome metal	1 0	CP1-31R-10	1SFA619100R3111	10	0.039
		0 1	CP1-31R-01	1SFA619100R3141	10	0.039
● Green	Black plastic	1 0	CP1-11G-10	1SFA619100R1112	10	0.025
	Chrome metal	1 0	CP1-31G-10	1SFA619100R3112	10	0.039
● Yellow	Black plastic	1 0	CP1-11Y-10	1SFA619100R1113	10	0.025
	Chrome metal	1 0	CP1-31Y-10	1SFA619100R3113	10	0.039
● Blue	Black plastic	1 0	CP1-11L-10	1SFA619100R1114	10	0.025
		1 0	CP1-31L-10	1SFA619100R3114	10	0.039
	0 1	CP1-31L-01	1SFA619100R3144	10	0.039	
○ Clear	Black plastic	1 0	CP1-11C-10	1SFA619100R1118	10	0.025
	Chrome metal	1 0	CP1-31C-10	1SFA619100R3118	10	0.039

Rated voltage 110...130 V AC / DC

● Red	Black plastic	1 0	CP1-12R-10	1SFA619100R1211	10	0.025
		0 1	CP1-12R-01	1SFA619100R1241	10	0.025
● Green	Black plastic	1 0	CP1-12G-10	1SFA619100R1212	10	0.025
● Yellow	Black plastic	1 0	CP1-12Y-10	1SFA619100R1213	10	0.025
● Blue	Black plastic	1 0	CP1-12L-10	1SFA619100R1214	10	0.025
○ Clear	Black plastic	1 0	CP1-12C-10	1SFA619100R1218	10	0.025

Rated voltage 220 V AC / DC

● Red	Black plastic	1 0	CP1-13R-10	1SFA619100R1311	10	0.025
		0 1	CP1-13R-01	1SFA619100R1341	10	0.025
● Green	Black plastic	1 0	CP1-13G-10	1SFA619100R1312	10	0.025
● Yellow	Black plastic	1 0	CP1-13Y-10	1SFA619100R1313	10	0.025
● Blue	Black plastic	1 0	CP1-13L-10	1SFA619100R1314	10	0.025
○ Clear	Black plastic	1 0	CP1-13C-10	1SFA619100R1318	10	0.025

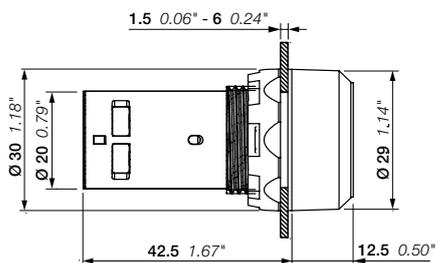

CP1

Dimensions (mm, inches)

Compact range

Illuminated flush pushbuttons - Maintained



Operator	Bezel	Contacts	Type	Order code	Pkg qty	Weight (1 pce)
kg						
Rated voltage 24 V AC / DC						
● Red	Black plastic	1 0	CP2-11R-10	1SFA619101R1111	10	0.025
		0 1	CP2-11R-01	1SFA619101R1141	10	0.025
● Green	Black plastic	1 0	CP2-11G-10	1SFA619101R1112	10	0.025
● Yellow	Black plastic	1 0	CP2-11Y-10	1SFA619101R1113	10	0.025
● Blue	Black plastic	1 0	CP2-11L-10	1SFA619101R1114	10	0.025
○ Clear	Black plastic	1 0	CP2-11C-10	1SFA619101R1118	10	0.025
Rated voltage 110...130 V AC / DC						
● Red	Black plastic	1 0	CP2-12R-10	1SFA619101R1211	10	0.025
		0 1	CP2-12R-01	1SFA619101R1241	10	0.025
● Green	Black plastic	1 0	CP2-12G-10	1SFA619101R1212	10	0.025
● Yellow	Black plastic	1 0	CP2-12Y-10	1SFA619101R1213	10	0.025
● Blue	Black plastic	1 0	CP2-12L-10	1SFA619101R1214	10	0.025
○ Clear	Black plastic	1 0	CP2-12C-10	1SFA619101R1218	10	0.025
Rated voltage 220 V AC / DC						
● Red	Black plastic	1 0	CP2-13R-10	1SFA619101R1311	10	0.025
		0 1	CP2-13R-01	1SFA619101R1341	10	0.025
● Green	Black plastic	1 0	CP2-13G-10	1SFA619101R1312	10	0.025
● Yellow	Black plastic	1 0	CP2-13Y-10	1SFA619101R1313	10	0.025
● Blue	Black plastic	1 0	CP2-13L-10	1SFA619101R1314	10	0.025
○ Clear	Black plastic	1 0	CP2-13C-10	1SFA619101R1318	10	0.025

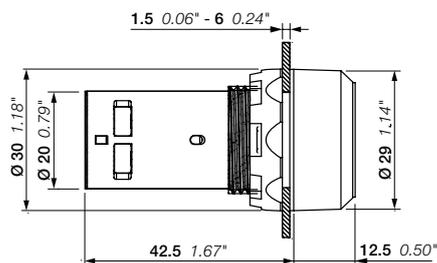

CP1
Dimensions (mm, inches)

Compact range

Illuminated extended pushbuttons - Momentary



CP3-11R-10

1SFC151210V0001



CP3-11G-10

1SFC151213V0001



CP3-11Y-10

1SFC151208V0001

Operator	Bezel	Contacts	Type	Order code	Pkg qty	Weight (1 pce)
kg						
Rated voltage 24 V AC / DC						
● Red	Black plastic	1 0	CP3-11R-10	1SFA619102R1111	10	0.025
		0 1	CP3-11R-01	1SFA619102R1141	10	0.025
● Green	Black plastic	1 0	CP3-11G-10	1SFA619102R1112	10	0.025
● Yellow	Black plastic	1 0	CP3-11Y-10	1SFA619102R1113	10	0.025
● Blue	Black plastic	1 0	CP3-11L-10	1SFA619102R1114	10	0.025
○ Clear	Black plastic	1 0	CP3-11C-10	1SFA619102R1118	10	0.025
Rated voltage 110...130 V AC / DC						
● Red	Black plastic	1 0	CP3-12R-10	1SFA619102R1211	10	0.025
		0 1	CP3-12R-01	1SFA619102R1241	10	0.025
● Green	Black plastic	1 0	CP3-12G-10	1SFA619102R1212	10	0.025
● Yellow	Black plastic	1 0	CP3-12Y-10	1SFA619102R1213	10	0.025
● Blue	Black plastic	1 0	CP3-12L-10	1SFA619102R1214	10	0.025
○ Clear	Black plastic	1 0	CP3-12C-10	1SFA619102R1218	10	0.025
Rated voltage 220 V AC / DC						
● Red	Black plastic	1 0	CP3-13R-10	1SFA619102R1311	10	0.025
		0 1	CP3-13R-01	1SFA619102R1341	10	0.025
● Green	Black plastic	1 0	CP3-13G-10	1SFA619102R1312	10	0.025
● Yellow	Black plastic	1 0	CP3-13Y-10	1SFA619102R1313	10	0.025
● Blue	Black plastic	1 0	CP3-13L-10	1SFA619102R1314	10	0.025
○ Clear	Black plastic	1 0	CP3-13C-10	1SFA619102R1318	10	0.025

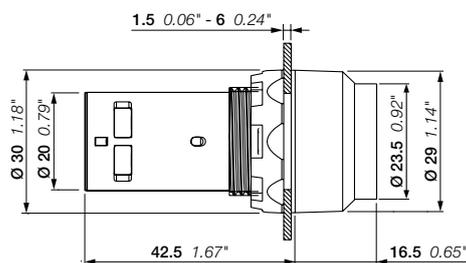

CP3

Dimensions (mm, inches)

Compact range

Illuminated extended pushbuttons - Maintained



CP4-11R-10

1SFC151210V0001



CP4-11G-10

1SFC151213V0001



CP4-11Y-10

1SFC151208V0001

Operator	Bezel	Contacts	Type	Order code	Pkg qty	Weight (1 pce)
kg						
Rated voltage 24 V AC / DC						
● Red	Black plastic	1 0	CP4-11R-10	1SFA619103R1111	10	0.025
		0 1	CP4-11R-01	1SFA619103R1141	10	0.025
● Green	Black plastic	1 0	CP4-11G-10	1SFA619103R1112	10	0.025
● Yellow	Black plastic	1 0	CP4-11Y-10	1SFA619103R1113	10	0.025
● Blue	Black plastic	1 0	CP4-11L-10	1SFA619103R1114	10	0.025
○ Clear	Black plastic	1 0	CP4-11C-10	1SFA619103R1118	10	0.025
Rated voltage 110...130 V AC / DC						
● Red	Black plastic	1 0	CP4-12R-10	1SFA619103R1211	10	0.025
		0 1	CP4-12R-01	1SFA619103R1241	10	0.025
● Green	Black plastic	1 0	CP4-12G-10	1SFA619103R1212	10	0.025
● Yellow	Black plastic	1 0	CP4-12Y-10	1SFA619103R1213	10	0.025
● Blue	Black plastic	1 0	CP4-12L-10	1SFA619103R1214	10	0.025
○ Clear	Black plastic	1 0	CP4-12C-10	1SFA619103R1218	10	0.025
Rated voltage 230 V AC / DC						
● Red	Black plastic	1 0	CP4-13R-10	1SFA619103R1311	10	0.025
		0 1	CP4-13R-01	1SFA619103R1341	10	0.025
● Green	Black plastic	1 0	CP4-13G-10	1SFA619103R1312	10	0.025
● Yellow	Black plastic	1 0	CP4-13Y-10	1SFA619103R1313	10	0.025
● Blue	Black plastic	1 0	CP4-13L-10	1SFA619103R1314	10	0.025
○ Clear	Black plastic	1 0	CP4-13C-10	1SFA619103R1318	10	0.025

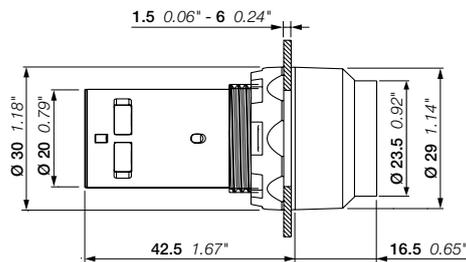

CP4

Dimensions (mm, inches)

Compact range

Non-illuminated mushroom pushbuttons - Momentary



CPM3-10R-11



CPM3-10G-11



CPM3-10Y-11



CPM3-10L-11



CPM3-10B-11

Operator	Contacts	Type	Order code	Pkg qty	Weight (1 pce)
					
kg					
Ø 40 mm					
● Red	1 1	CPM3-10R-11	1SFA619126R1071	1	0.036
● Green	1 1	CPM3-10G-11	1SFA619126R1072	1	0.036
● Yellow	1 1	CPM3-10Y-11	1SFA619126R1073	1	0.036
● Blue	1 1	CPM3-10L-11	1SFA619126R1074	1	0.036
● Black	1 1	CPM3-10B-11	1SFA619126R1076	1	0.036

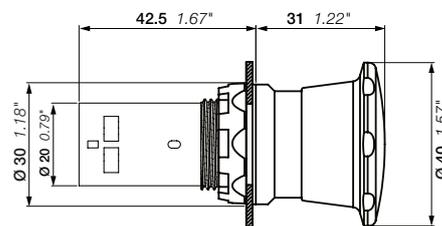

CPM3
Dimensions (mm, inches)

Compact range

Non-illuminated emergency stop pushbuttons



Description

The emergency stop pushbuttons conform to the standard EN/IEC 60947-5-5, Safety of machinery standard EN/ISO 13850, IEC 60204-1 and to Machinery directive 2006/42/EC.

Operator	Release method	Contacts	Type	Order code	Pkg qty	Weight (1 pce)
Ø 30 mm						
● Red	Twist release	0 1	CE3T-10R-01	1SFA619500R1041	1	0.032
		1 1	CE3T-10R-11	1SFA619500R1071	1	0.032
		0 2	CE3T-10R-02	1SFA619500R1051	1	0.032
● Red	Pull release	0 1	CE3P-10R-01	1SFA619501R1041	1	0.032
		1 1	CE3P-10R-11	1SFA619501R1071	1	0.032
		0 2	CE3P-10R-02	1SFA619501R1051	1	0.032
● Red	Key code 455	0 1	CE3K1-10R-01	1SFA619502R1041	1	0.060
		1 1	CE3K1-10R-11	1SFA619502R1071	1	0.060
		0 2	CE3K1-10R-02	1SFA619502R1051	1	0.060
Ø 40 mm						
● Red	Twist release	0 1	CE4T-10R-01	1SFA619550R1041	1	0.036
		1 1	CE4T-10R-11	1SFA619550R1071	1	0.036
		0 2	CE4T-10R-02	1SFA619550R1051	1	0.036
● Red	Pull release	0 1	CE4P-10R-01	1SFA619551R1041	1	0.036
		1 1	CE4P-10R-11	1SFA619551R1071	1	0.036
		0 2	CE4P-10R-02	1SFA619551R1051	1	0.036
● Red	Key code 455	0 1	CE4K1-10R-01	1SFA619552R1041	1	0.064
		1 1	CE4K1-10R-11	1SFA619552R1071	1	0.064
		0 2	CE4K1-10R-02	1SFA619552R1051	1	0.064

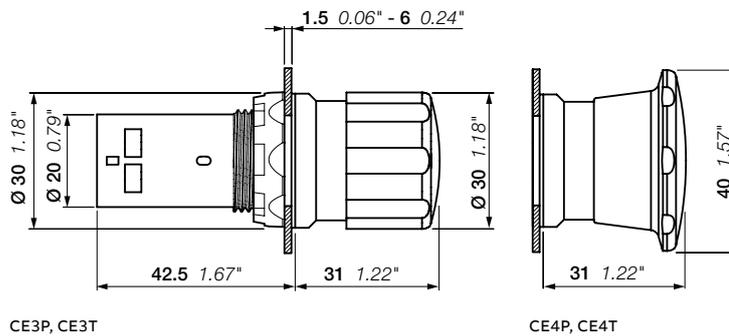

CE3P, CE3T

CE4P, CE4T

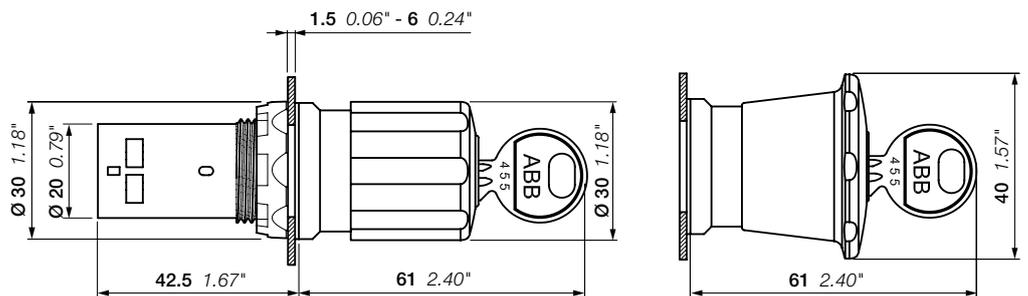

CE3K

CE4K

Dimensions (mm, inches)

Compact range

Non-illuminated machine stop pushbuttons



Operator	Release method	Contacts	Type	Order code	Pkg qty	Weight (1 pce)
kg						
Ø 30 mm						
● Black	Twist release	0 1	CE3T-10B-01	1SFA619500R1046	1	0.032
		1 1	CE3T-10B-11	1SFA619500R1076	1	0.032
● Black	Pull release	1 1	CE3P-10B-11	1SFA619501R1076	1	0.032
● Black	Key code 455	1 1	CE3K1-10B-11	1SFA619502R1076	1	0.060
Ø 40 mm						
● Black	Twist release	1 0	CE4T-10B-10	1SFA619550R1016	1	0.032
		0 1	CE4T-10B-01	1SFA619550R1046	1	0.032
		1 1	CE4T-10B-11	1SFA619550R1076	1	0.032
		2 0	CE4T-10B-20	1SFA619550R1026	1	0.032
		0 2	CE4T-10B-02	1SFA619550R1056	1	0.032
● Black	Pull release	1 1	CE4P-10B-11	1SFA619551R1076	1	0.032
● Black	Key code 455	1 1	CE4K1-10B-11	1SFA619552R1076	1	0.064

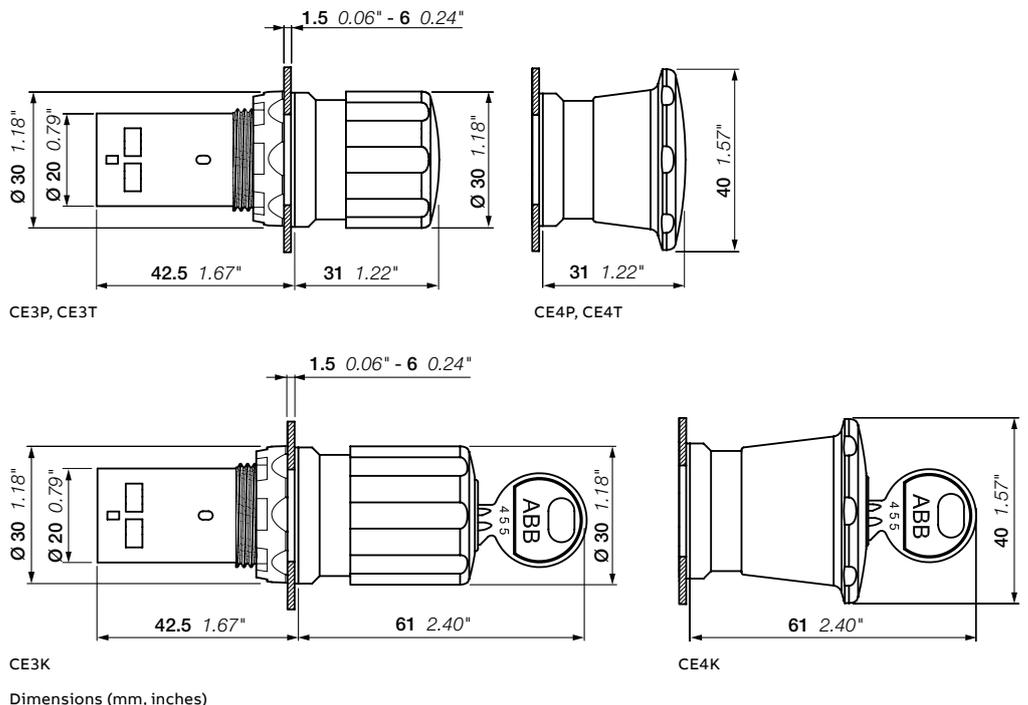

Compact range

Heavy duty pushbuttons



15FC151025V0001

CP6-10R-11



15FC151024V0001

CP6-10G-11



15FC151023V0001

CP6-10B-11

Description

Silicone rubber cap.

Color	Contacts	Type	Order code	Pkg qty	Weight (1 pce)
● Red	1 1	CP6-10R-11	1SFA619105R1071	10	0.031
	2 0	CP6-10R-20	1SFA619105R1021	10	0.031
	0 2	CP6-10R-02	1SFA619105R1051	10	0.031
● Green	1 1	CP6-10G-11	1SFA619105R1072	10	0.031
	2 0	CP6-10G-20	1SFA619105R1022	10	0.031
● Black	1 1	CP6-10B-11	1SFA619105R1076	10	0.031
	2 0	CP6-10B-20	1SFA619105R1026	10	0.031
	0 2	CP6-10B-02	1SFA619105R1056	10	0.031

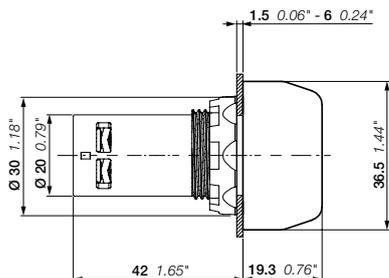

CP6

Dimensions (mm, inches)

Compact range

Pilot lights



1SFC151338V0001

CL2-502R



1SFC151339V0001

CL2-506G



1SFC151340V0001

CL2-508Y



1SFC151341V0001

CL2-506L



1SFC151342V0001

CL2-506C

Description

Integrated LED, no bulb needed.

Color	Rated current mA	Anti-in-ductive voltage Vpeak	Wave-length nm	Illumi-nation lx	Type	Order code	Pkg qty	Weight (1 pce) kg
-------	---------------------	----------------------------------	-------------------	---------------------	------	------------	---------	----------------------

Voltage 6.3 V

● Red	16	2	625	70	CL2-506R	1SFA619403R5061	10	0.016
● Green	16	2	520	125	CL2-506G	1SFA619403R5062	10	0.016
● Yellow	16	2	590	75	CL2-506Y	1SFA619403R5063	10	0.016
● Blue	16	2	470	10	CL2-506L	1SFA619403R5064	10	0.016
○ Clear	16	2	(1)	290	CL2-506C	1SFA619403R5068	10	0.016

Voltage 12 V DC

● Red	16	2	625	110	CL2-501R	1SFA619403R5011	10	0.016
● Green	16	2.5	520	165	CL2-501G	1SFA619403R5012	10	0.016
● Yellow	16	2.5	590	85	CL2-501Y	1SFA619403R5013	10	0.016
● Blue	16	2.5	470	15	CL2-501L	1SFA619403R5014	10	0.016
○ Clear	16	2.5	(1)	320	CL2-501C	1SFA619403R5018	10	0.016

Voltage 24 V AC / DC

● Red	16	6	625	80	CL2-502R	1SFA619403R5021	10	0.016
● Green	16	6	520	135	CL2-502G	1SFA619403R5022	10	0.016
● Yellow	16	6	590	55	CL2-502Y	1SFA619403R5023	10	0.016
● Blue	16	6	470	10	CL2-502L	1SFA619403R5024	10	0.016
○ Clear	16	6	(1)	230	CL2-502C	1SFA619403R5028	10	0.016

Voltage 48 ... 60 V AC / DC

● Red	13-17	7	625	75	CL2-507R	1SFA619403R5071	10	0.016
● Green	13-17	7	520	140	CL2-507G	1SFA619403R5072	10	0.016
● Yellow	13-17	7	590	80	CL2-507Y	1SFA619403R5073	10	0.016
● Blue	13-17	7	470	10	CL2-507L	1SFA619403R5074	10	0.016
○ Clear	13-17	7	(1)	260	CL2-507C	1SFA619403R5078	10	0.016

Voltage 110 ... 130 V AC

● Red	15-17	20	625	85	CL2-513R	1SFA619403R5131	10	0.016
● Green	15-17	20	520	90	CL2-513G	1SFA619403R5132	10	0.016
● Yellow	15-17	20	590	85	CL2-513Y	1SFA619403R5133	10	0.016
● Blue	15-17	20	470	10	CL2-513L	1SFA619403R5134	10	0.016
○ Clear	15-17	20	(1)	340	CL2-513C	1SFA619403R5138	10	0.016

Voltage 110 ... 130 V DC

● Red	8-9	20	625	55	CL2-515R	1SFA619403R5151	10	0.016
● Green	8-9	20	520	125	CL2-515G	1SFA619403R5152	10	0.016
● Yellow	8-9	20	590	50	CL2-515Y	1SFA619403R5153	10	0.016
● Blue	8-9	20	470	10	CL2-515L	1SFA619403R5154	10	0.016
○ Clear	8-9	20	(1)	210	CL2-515C	1SFA619403R5158	10	0.016

(1) X = 0.31, Y = 0.32

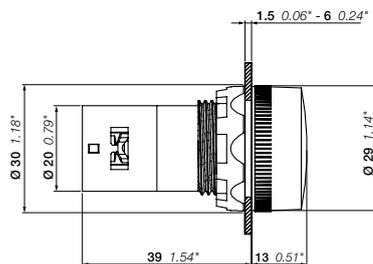

CL2

Dimensions (mm, inches)

Compact range

Pilot lights



CL2-502R

1SFCL151338V0001



CL2-506G

1SFCL151339V0001



CL2-508Y

1SFCL151340V0001



CL2-506L

1SFCL151341V0001



CL2-506C

1SFCL151342V0001

Description

Integrated LED, no bulb needed.

Color	Rated current mA	Anti-inductive voltage Vpeak	Wave-length nm	Illumi-nation lx	Type	Order code	Pkg qty	Weight (1 pce) kg
-------	---------------------	---------------------------------	-------------------	---------------------	------	------------	---------	----------------------

Voltage 220 V DC

● Red	6	20	625	40	CL2-520R	1SFA619403R5201	10	0.016
● Green	6	20	520	90	CL2-520G	1SFA619403R5202	10	0.016
● Yellow	6	20	590	30	CL2-520Y	1SFA619403R5203	10	0.016
● Blue	6	20	470	5	CL2-520L	1SFA619403R5204	10	0.016
○ Clear	6	20	(1)	120	CL2-520C	1SFA619403R5208	10	0.016

Voltage 230 V AC

● Red	17	30	625	95	CL2-523R	1SFA619403R5231	10	0.016
● Green	17	35	520	155	CL2-523G	1SFA619403R5232	10	0.016
● Yellow	17	35	590	70	CL2-523Y	1SFA619403R5233	10	0.016
● Blue	17	35	470	10	CL2-523L	1SFA619403R5234	10	0.016
○ Clear	17	35	(1)	225	CL2-523C	1SFA619403R5238	10	0.016

Rated voltage 230 V AC high anti-inductive voltage (2)

● Red	17	60	625	75	CL2-623R	1SFA619403R6231	10	0.016
● Green	17	80	520	70	CL2-623G	1SFA619403R6232	10	0.016
● Yellow	17	70	590	50	CL2-623Y	1SFA619403R6233	10	0.016
● Blue	17	80	470	5	CL2-623L	1SFA619403R6234	10	0.016
○ Clear	17	80	(1)	155	CL2-623C	1SFA619403R6238	10	0.016

Rated voltage 380 ... 415 V AC

● Red	15-17	55	625	85	CL2-542R	1SFA619403R5421	10	0.016
● Green	15-17	65	520	130	CL2-542G	1SFA619403R5422	10	0.016
● Yellow	15-17	65	590	60	CL2-542Y	1SFA619403R5423	10	0.016
● Blue	15-17	65	470	10	CL2-542L	1SFA619403R5424	10	0.016
○ Clear	15-17	65	(1)	395	CL2-542C	1SFA619403R5428	10	0.016

(1) X = 0.31, Y = 0.32

(2) Higher threshold to light up LED to be used in application where there is risk of large induced voltages.

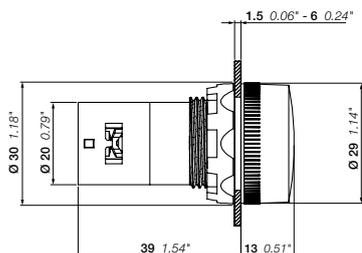

CL2

Dimensions (mm, inches)

Compact range

Pilot lights BA 9s



CL-100R



CL-100L

Description

Bulb not included and should be ordered separately, see Accessories section for order codes and information.

Color	Type	Order code	Pkg qty	Weight (1 pce) kg
● Red	CL-100R	1SFA619402R1001	10	0.018
● Green	CL-100G	1SFA619402R1002	10	0.018
● Yellow	CL-100Y	1SFA619402R1003	10	0.018
● Blue	CL-100L	1SFA619402R1004	10	0.018
○ White	CL-100W	1SFA619402R1005	10	0.018
○ Clear	CL-100C	1SFA619402R1008	10	0.018

Accessories for compact range

Flashing LED bulbs for CL-100 pilot lights

Color	Wavelength nm	Type	Order code	Pkg qty	Weight (1 pce) kg
Rated voltage 24 V DC rated current 25 mA, service life > 50 000 h					
● Red	630	–	4950512-1	20	0.005
● Green	565	–	4950512-2	20	0.005
● Yellow	585	–	4950512-3	20	0.005

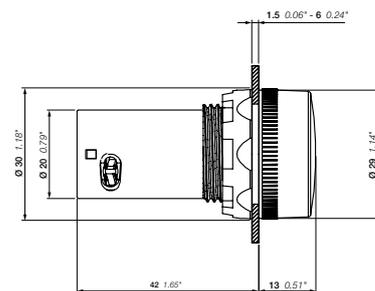

CL100
Dimensions (mm, inches)

Accessories for compact range

LED bulbs for CL-100 pilot lights



KA2...

1SFC151178F0001

Color	Wavelength nm	Luminance mdc	Type	Order code	Pkg qty	Weight (1 pce) kg
Rated voltage 12 V DC rated current 15 mA, service life > 50 000 h						
● Red	630	250	KA2-2011	1SFA616921R2011	20	0.005
● Green	525	1000	KA2-2012	1SFA616921R2012	20	0.005
● Yellow	592	250	KA2-2013	1SFA616921R2013	20	0.005
● Blue	470	450	KA2-2014	1SFA616921R2014	20	0.005
○ White	(1)	600	KA2-2015	1SFA616921R2015	20	0.005
Rated voltage 24 V (AC) / DC rated current 15 mA, service life > 50 000 h						
● Red	630	250	KA2-2021	1SFA616921R2021	20	0.005
● Green	525	800	KA2-2022	1SFA616921R2022	20	0.005
● Yellow	592	250	KA2-2023	1SFA616921R2023	20	0.005
● Blue	470	400	KA2-2024	1SFA616921R2024	20	0.005
○ White	(1)	500	KA2-2025	1SFA616921R2025	20	0.005
Rated voltage 36 V (AC) / DC rated current 12 mA, service life > 50 000 h						
● Red	630	200	KA2-2031	1SFA616921R2031	20	0.005
● Green	525	2000	KA2-2032	1SFA616921R2032	20	0.005
● Yellow	592	200	KA2-2033	1SFA616921R2033	20	0.005
● Blue	470	750	KA2-2034	1SFA616921R2034	20	0.005
○ White	(1)	1400	KA2-2035	1SFA616921R2035	20	0.005
Rated voltage 48 V (AC) / DC rated current 12 mA, service life > 50 000 h						
● Red	630	200	KA2-2041	1SFA616921R2041	20	0.005
● Green	525	1700	KA2-2042	1SFA616921R2042	20	0.005
● Yellow	592	240	KA2-2043	1SFA616921R2043	20	0.005
● Blue	470	720	KA2-2044	1SFA616921R2044	20	0.005
○ White	(1)	1200	KA2-2045	1SFA616921R2045	20	0.005
Rated voltage 60 V (AC) / DC rated current 10 mA, service life > 50 000 h						
● Red	630	160	KA2-2051	1SFA616921R2051	20	0.005
● Green	525	1400	KA2-2052	1SFA616921R2052	20	0.005
● Yellow	592	200	KA2-2053	1SFA616921R2053	20	0.005
● Blue	470	600	KA2-2054	1SFA616921R2054	20	0.005
○ White	(1)	1000	KA2-2055	1SFA616921R2055	20	0.005
Rated voltage 110 ... 130 V AC rated current 4-6 mA, service life 25 000 h						
● Red	630	60-100	KA2-2131	1SFA616921R2131	20	0.005
● Green	525	500-850	KA2-2132	1SFA616921R2132	20	0.005
● Yellow	592	70-120	KA2-2133	1SFA616921R2133	20	0.005
● Blue	470	220-350	KA2-2134	1SFA616921R2134	20	0.005
○ White	(1)	350-600	KA2-2135	1SFA616921R2135	20	0.005
Rated voltage 110 ... 130 V (AC) / DC rated current 4-6 mA, service life 25 000 h						
● Red	630	60	KA2-2141	1SFA616921R2141	20	0.005
● Green	525	500	KA2-2142	1SFA616921R2142	20	0.005
● Yellow	592	70	KA2-2143	1SFA616921R2143	20	0.005
● Blue	470	220	KA2-2144	1SFA616921R2144	20	0.005
○ White	(1)	350	KA2-2145	1SFA616921R2145	20	0.005
Rated voltage 230 V AC rated current 4 mA, service life 25 000 h						
● Red	630	60	KA2-2221	1SFA616921R2221	20	0.005
● Green	525	500	KA2-2222	1SFA616921R2222	20	0.005
● Yellow	592	70	KA2-2223	1SFA616921R2223	20	0.005
● Blue	470	220	KA2-2224	1SFA616921R2224	20	0.005
○ White	(1)	350	KA2-2225	1SFA616921R2225	20	0.005
Rated voltage 230 V (AC) / DC rated current 4 mA, service life 25 000 h						
● Red	630	60	KA2-2231	1SFA616921R2231	20	0.005
● Green	525	500	KA2-2232	1SFA616921R2232	20	0.005
● Yellow	592	70	KA2-2233	1SFA616921R2233	20	0.005
● Blue	470	220	KA2-2234	1SFA616921R2234	20	0.005
○ White	(1)	350	KA2-2235	1SFA616921R2235	20	0.005

Note: Choose the same color on the LED as on the lamp cap. (1) X=0.31, Y=0.32 according to the ICI chromaticity diagram.

Compact range

Non-illuminated selector switches - 2-position



15FCL15125V0001

C2SS1-10B-10



15FCL15135V0001

C2SS3-30B-10

Contacts actuated

2-position selector switch
Contacts included,

		actuated in position C			
		NC	NO	NC	NO
1 NO		11	13	21	23
2 NO		12	14	22	24
1 NC		-	1	-	-
2 NC		-	1	-	1
1 NO + 1 NC		-	1	1	-

Description

Compact selector switches are delivered in black color.

Operating principle	Bezel	Contacts	Type	Order code	Pkg qty	Weight (1 pce)	
	Black plastic	1 0	C2SS1-10B-10	1SFA619200R1016	10	0.02	
		0 1	C2SS1-10B-01	1SFA619200R1046	10	0.02	
		1 1	C2SS1-10B-11	1SFA619200R1076	10	0.024	
		2 0	C2SS1-10B-20	1SFA619200R1026	10	0.024	
		1 0	C2SS1-30B-10	1SFA619200R3016	10	0.029	
		0 1	C2SS1-30B-01	1SFA619200R3046	10	0.029	
	Chrome metal	1 1	C2SS1-30B-11	1SFA619200R3076	10	0.032	
		2 0	C2SS1-30B-20	1SFA619200R3026	10	0.032	
		Black plastic	1 0	C2SS2-10B-10	1SFA619201R1016	10	0.02
			0 1	C2SS2-10B-01	1SFA619201R1046	10	0.02
			1 1	C2SS2-10B-11	1SFA619201R1076	10	0.024
			2 0	C2SS2-10B-20	1SFA619201R1026	10	0.024
1 0	C2SS2-30B-10		1SFA619201R3016	10	0.029		
0 1	C2SS2-30B-01		1SFA619201R3046	10	0.029		
Chrome metal	1 1	C2SS2-30B-11	1SFA619201R3076	10	0.032		
	2 0	C2SS2-30B-20	1SFA619201R3026	10	0.032		
	Black plastic	1 0	C2SS3-10B-10	1SFA619202R1016	10	0.02	
		0 1	C2SS3-10B-01	1SFA619202R1046	10	0.02	
		1 1	C2SS3-10B-11	1SFA619202R1076	10	0.024	
		2 0	C2SS3-10B-20	1SFA619202R1026	10	0.024	
1 0		C2SS3-30B-10	1SFA619202R3016	10	0.029		
1 1		C2SS3-30B-11	1SFA619202R3076	10	0.032		
Chrome metal	2 0	C2SS3-30B-20	1SFA619202R3026	10	0.032		
	Chrome metal	1 0	C2SS5-30B-10	1SFA619204R3016	10	0.029	
		1 1	C2SS5-30B-11	1SFA619204R3076	10	0.032	

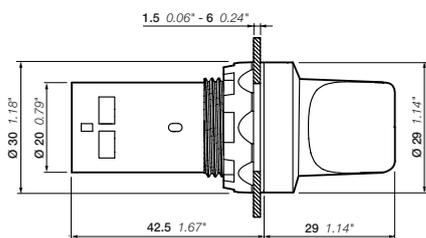

C2SS, short handle
Dimensions (mm, inches)

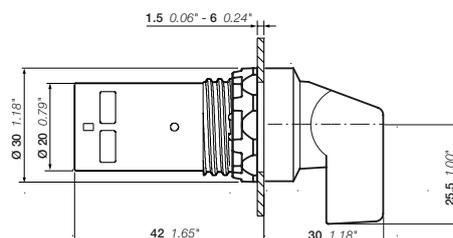

C2SS, long handle

Compact range

Non-illuminated selector switches - 3-position



C3SS1-10B-11



C3SS2-30B-20

Contacts actuated

3-position selector switch
Contacts included,

actuated in position:		A				C			
		NC	NO	NC	NO	NC	NO	NC	NO
		21	23	11	13				
		22	24	12	14				
2 NO		-	1	-	1				
2 NC		1	-	1	-				
1 NO + 1 NC		1	-	-	1				

Description

Compact selector switches operators are delivered in black color.

Operating principle	Bezel	Contacts	Type	Order code	Pkg qty	Weight (1 pce)
						kg

Short handle

	Black plastic	1 1	C3SS1-10B-11	1SFA619210R1076	10	0.024
		2 0	C3SS1-10B-20	1SFA619210R1026	10	0.024
	Chrome metal	1 1	C3SS1-30B-11	1SFA619210R3076	10	0.032
		2 0	C3SS1-30B-20	1SFA619210R3026	10	0.032
	Black plastic	1 1	C3SS2-10B-11	1SFA619211R1076	10	0.024
		2 0	C3SS2-10B-20	1SFA619211R1026	10	0.024
	Chrome metal	1 1	C3SS2-30B-11	1SFA619211R3076	10	0.032
		2 0	C3SS2-30B-20	1SFA619211R3026	10	0.032
	Black plastic	1 1	C3SS3-10B-11	1SFA619212R1076	10	0.024
		2 0	C3SS3-10B-20	1SFA619212R1026	10	0.024
	Chrome metal	1 1	C3SS3-30B-11	1SFA619212R3076	10	0.032
		2 0	C3SS3-30B-20	1SFA619212R3026	10	0.032
	Black plastic	1 1	C3SS7-10B-11	1SFA619216R1076	10	0.024
		2 0	C3SS7-10B-20	1SFA619216R1026	10	0.024
	Chrome metal	2 0	C3SS7-30B-20	1SFA619216R3026	10	0.032

Long handle

	Black plastic	1 1	C3SS4-10B-11	1SFA619213R1076	10	0.024
		2 0	C3SS4-10B-20	1SFA619213R1026	10	0.024
	Black plastic	1 1	C3SS5-10B-11	1SFA619214R1076	10	0.024
		2 0	C3SS5-10B-20	1SFA619214R1026	10	0.024
	Chrome metal	2 0	C3SS5-30B-20	1SFA619214R3026	10	0.032

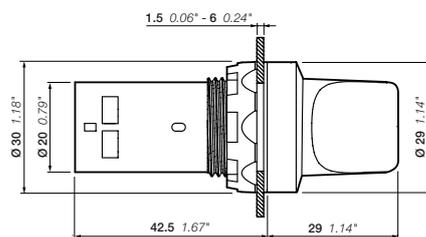

C3SS, short handle
Dimensions (mm, inches)

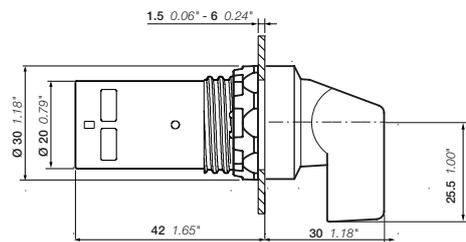

C3SS, long handle

Compact range

Buzzers



1SFC15151V0001

CB1-600G



1SFC15159V0001

CB1-610R



1SFC15158V0001

CB1-610Y



1SFC15160V0001

CB1-620B

Illuminated

Color	Light and sound output	Rated current mA	Luminance mcd	Type	Order code	Pkg qty	Weight (1 pce) kg
-------	------------------------	---------------------	------------------	------	------------	---------	----------------------

Rated voltage 24 V AC / DC

● Green	Continuous	48	126	CB1-600G	1SFA619600R6002	10	0.021
● Red	Pulsation	53	60	CB1-610R	1SFA619600R6101	10	0.021
● Yellow	Pulsation	53	60	CB1-610Y	1SFA619600R6103	10	0.021

Rated voltage 110 ... 130 V AC

● Green	Continuous	55	126	CB1-601G	1SFA619600R6012	10	0.021
● Red	Pulsation	70	60	CB1-611R	1SFA619600R6111	10	0.021
● Yellow	Pulsation	70	60	CB1-611Y	1SFA619600R6113	10	0.021

Rated voltage 110 ... 130 V DC

● Green	Continuous	15	126	CB1-602G	1SFA619600R6022	10	0.021
● Red	Pulsation	15	60	CB1-612R	1SFA619600R6121	10	0.021
● Yellow	Pulsation	15	60	CB1-612Y	1SFA619600R6123	10	0.021

Rated voltage 230 V AC

● Green	Continuous	55	126	CB1-603G	1SFA619600R6032	10	0.021
● Red	Pulsation	70	60	CB1-613R	1SFA619600R6131	10	0.021
● Yellow	Pulsation	70	60	CB1-613Y	1SFA619600R6133	10	0.021

Non-Illuminated

Color	Sound output	Rated current mA	Luminance mcd	Type	Order code	Pkg qty	Weight (1 pce) kg
-------	--------------	---------------------	------------------	------	------------	---------	----------------------

Rated voltage 24 V AC / DC

● Black	Continuous	40	-	CB1-620B	1SFA619600R6206	10	0.021
	Pulsation	48	-	CB1-630B	1SFA619600R6306	10	0.021

Rated voltage 110 ... 130 V AC

● Black	Continuous	40	-	CB1-621B	1SFA619600R6216	10	0.021
	Pulsation	48	-	CB1-631B	1SFA619600R6316	10	0.021

Rated voltage 110 ... 130 V DC

● Black	Continuous	15	-	CB1-622B	1SFA619600R6226	10	0.021
	Pulsation	15	-	CB1-632B	1SFA619600R6326	10	0.021

Rated voltage 230 V AC

● Black	Continuous	40	-	CB1-623B	1SFA619600R6236	10	0.021
	Pulsation	40	-	CB1-633B	1SFA619600R6336	10	0.021

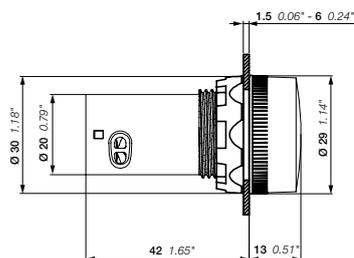

CB1
Dimensions (mm, inches)

Compact range

Accessories



Description	Bezel / color	Type	Order code	Pkg qty	Weight (1pce) kg
30 mm adaptors for 22 mm operator (1.5 - 4 mm panel thickness)					
Emergency stop pushbuttons, MPM	Black plastic	KA1-8027	1SFA616920R8027	1	0.007
	Chrome metal	KA1-8028	1SFA616920R8028	1	0.021
Pushbuttons, selector switches, pilot lights, potentiometers, emergency stop pushbuttons, MPE	Black plastic	KA1-8029	1SFA616920R8029	1	0.010
Flush mounted pushbuttons	Chrome metal	KA1-8073	1SFA616920R8073	1	0.050
Flush mounted selector switches	Chrome metal	MA1-8074	1SFA611920R8074	1	0.050
Protective membrane, silicone					
Flush pushbutton		MA1-8052	1SFA611920R8052	10	0.002
Extended pushbutton		MA1-8002	1SFA611920R8002	10	0.002
Protective ring					
To prevent accidental operation. Cannot be used together with Legend plate holder					
Flush and extended pushbuttons	Clear plastic	-	SK615512-1	10	0.002
Flush pushbuttons	Metal and black plastic	KA1-8010	1SFA616920R8010	10	0.008
Bezel					
Pushbuttons	Black plastic	KA1-8022	1SFA616920R8022	10	0.002
	Chrome plastic	KA1-8020	1SFA616920R8020	10	0.002
	Chrome metal	KA1-8021	1SFA616920R8021	10	0.015
Selector switches	Black plastic	CA1-8077	1SFA619920R8077	10	0.002
	Chrome metal	CA1-8078	1SFA619920R8078	10	0.010
Square bezel					
Black plastic		-	SK616016-2	10	0.001
Lockable shroud					
Pushbuttons, selector switches	Plastic	MA1-8153	1SFA611920R8153	10	0.023
Emergency stop 30 mm	Metal	-	SK615502-D	1	0.080
Touch guard					
Touch guard		MA1-8152	1SFA611920R8152	10	0.023
Shroud with anti rotation tabs, slot for water drainage					
Emergency stop, machine stop 40 mm	● Yellow	CA1-8053	1SFA619920R8053	10	0.016
	● Grey	CA1-8054	1SFA619920R8054	10	0.016
Lamp changing tool					
Lamp changing tool		KA1-8072	1SFA616920R8072	1	0.002

Note: Din-rail adaptor should be used with 2 contact blocks for rear mounting type MCB..B.

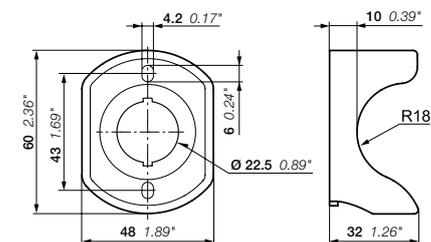

CA1
Dimensions (mm, inches)

Compact range

Accessories



CA1-8080

1SFC151276V0001



MA1-8015

1SFC151275V0001



MA1-8149

1SFC151004F0001



MA1-8019

1SFC151385V0001

Description	Bezel / color	Type	Order code	Pkg qty	Weight (1pce) kg
DIN-rail adaptor					
DIN-rail adaptor with 2 dummy block		CA1-8080	1SFA619920R8080	1	0.028
Mounting tools					
For tightening the locking nut					
Plastic / Mounting tool manual		MA1-8015	1SFA611920R8015	1	0.021
Metal / Mounting tool for power tool		MA1-8149	1SFA611920R8149	1	0.155
Extra key					
Key code 455			SK616021-71	10	0.007
Key code 421			SK616021-72	10	0.007
Key code 3433-E			SK616021-73	10	0.007
Locking nut					
Locking nut		MA1-8019	1SFA611920R8019	10	0.001

Compact range

Technical data

Standards and approvals

IEC / EN 60947-1	Low Voltage switchgear and controlgear - Part 1: General rules
IEC / EN 60947-5-1	Low Voltage switchgear and controlgear - part 5-1: control circuit devices and switching elements - Electromechanical control circuit devices
IEC / EN 60947-5-5	Low Voltage switchgear and controlgear - part 5-5: control circuit devices and switching elements - Electrical emergency stop device with mechanical latching function
IEC / EN 60073	Basic and safety principles for man-machine interface, marking and identification coding principles for indicators and actuators
IEC / EN 60529	Degrees of protection provided by enclosures (IP code)
EN 50013	Low Voltage switchgear and controlgear for industrial use, terminal marking and distinctive number for particular control switches
DIN 40050-9	Road vehicles; degrees of protection (IP-code); protection against foreign objects; water and contact; electrical equipment
UL 508	Industrial control equipment
CSA C22.2 No 14	Industrial control equipment

Environmental data

Degrees of protection

Operators	IEC/EN DIN	UL/CSA
Pushbutton	IP66, IP67 and IP69K	Type 1, 3R, 4, 4X, 12, 13
Selector switches	IP66, IP67 and IP69K	Type 1, 3R, 4, 4X, 12, 13
Buzzer	IP66, IP67 and IP69K	Type 1, 3R, 4, 4X, 12, 13
Heavy duty	IP66, IP67 and IP69K	Type 1, 3R, 4, 4X, 12, 13
Pilot lights	IP66, IP67 and IP69K	Type 1, 3R, 4, 4X, 12, 13
Emergency stops	IP66, IP67 and IP69K	Type 1, 3R, 4, 4X, 12, 13
Terminals	IP20	-

Temperature

Ambient temperature during operation	-25 to +70 °C
Storage temperature	-40 to +85 °C

Technical data

Connecting capacity

Compact range M3.0 (pushbutton, selector switch, emergency stop)

	1x 0.5...1.5 mm ²
	2x 0.5...1.5 mm ²
	1x 0.5...1.5 mm ²
	2x 0.5...1.5 mm ²
	1x 0.5...1.5 mm ²
	2x 0.5...1.5 mm ²
	1x 0.5...1.5 mm ²
	2x 0.5...1.5 mm ²
	L < 5.9 mm
	l > 3.0 mm
Stripping length	6.0 mm

Compact range M3.5 (Pilot light)

	1x 0.75...2.5 mm ²
	2x 0.75...2.5 mm ²
	1x 0.75...2.5 mm ²
	2x 0.75...2.5 mm ²
	1x 0.75...2.5 mm ²
	2x 0.75...2.5 mm ²
	1x 0.75...2.5 mm ²
	2x 0.75...2.5 mm ²
	L < 7.0 mm
	l > 3.5 mm
Stripping length	8.0 mm

Tightening torque

Cable terminals M3	0.8 Nm
Cable terminals M3.5	0.9 Nm
Recommended screw-driver for cable terminal	Pozidriv 2
Operators locking nut	Min. 2 Nm / Max. 2.3 Nm

Short circuit protection

Max. fuse at 1 kA	gG 10A
-------------------	--------

Mechanical life

Pushbuttons, selector switches, heavy duty	500 000 operations
Emergency stop pushbutton	50 000 operations

LED products (Pilot lights, illuminated pushbuttons)

Service life for LED means number of service hours until the brightness has been reduced down 50%. Service life 50 000 h, operating at 25 °C, 40~70%rh (relative humidity)

Color of white LED	x = 0.31 Y = 0.32 means the position of color in the ICI chromaticity diagram
Voltage tolerance on LED	-30 to +10% voltage is acceptable without affecting the service life
Voltage peaks on LED	Voltage peaks up to 1000 V current peaks up to 500 mA during a few msec
Glowing light	All integrated LED have a function built in to cut leakage currents
Rated frequency	50/60 Hz for AC supplied products

Make-and-break contacts

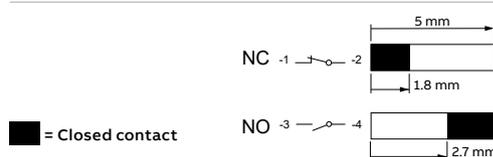

Compact range

Technical data

Material	
No ozone depleting substances in the products.	
All front of panel plastic components are made of polycarbonate	
PC polycarbonate	High impact strength, good outdoor resistance. Chemical resistance (see table below)
PSU polysulphone	Can withstand high temperatures, acids, basic solutions, alkaline compounds, oils, alcohols
PA polyamide	Can withstand high temperatures, aliphatic, aromatic and chlorinated hydrocarbons, esters, ketone-aldehydes, alcohols and basic solutions
PBT	Can withstand high temperature, aliphatic and aromatic hydrocarbons, acids, basic solutions, alcohols, grease and oils
Zinc	Good corrosion resistance in inland-, sea and industrial atmosphere
Light-alloy	Good corrosion resistance in inland-, sea and industrial atmosphere
Chemical resistance for polycarbonate	
Chemical class	Effects
Acids	No significant effect under most typical conditions of concentration and temperature
Alcohols and alkalis	Generally compatible at low concentration and room temperature. Higher concentrations and elevated temperatures can result in etching and attack evidenced by decomposition
Aliphatic hydrocarbons	Generally compatible
Amines	Surface crystallization and chemical attack Avoid
Aromatic hydrocarbons	Partial solvents and severe stress cracking agents (i.e., xylene, toluene). Avoid
Detergents and cleaners	Mild soap solutions are generally compatible. Strong alkaline materials should be avoided
Esters	Cause severe crystallization. Partial solvents. Avoid
Greases and oils	Pure petroleum types generally compatible. Many additives used with them are not
Halogenated, hydrocarbons	Solvents. Avoid
Ketones	Cause severe crystallization and stress cracking. Partial solvents. Avoid
Silicone oil and greases	Generally compatible up to 85 °C

Note: Specified degree of protection is for operator mounted on panel. If other items are mounted in between, please make sure that they are correctly sealed.

Electrical data			
Contacts			
Rated frequency	50-60 Hz		
Ratings as per IEC 60947-5-1			
Rated insulation voltage, U_i	300 V		
Rated thermal current, I_{th}	5 A		
Rated operational current, I_e	at: 240 V	1 A	
Utilization category AC 15,			
Rated operational current, I_e	at: 24 V	0.3 A	
utilisation category DC 13,	at: 125 V	0.2 A	
Rated impulse withstand voltage	U_{imp}	6 kV	
Pollution degree	3		
Ratings as per UL, CSA, NEMA		C300 AC	R300 DC
Rated insulation voltage	250 V		250 V
Rated thermal current	2.5 A		1 A
Rated operational current	at: 120 V	1.5 A	
	at: 125 V		0.22 A
	at: 240 V	0.75 A	
	at: 250 V		0.11 A
Short circuit protection			
Max. fuse at 1 kA	gG 10A		
Buzzer			
Short circuit protection			
Max. fuse at 1 kA	gG 10A		
Ratings as per IEC 60947-5-1			
Rated insulation voltage, U_i	300 V		
Rated impulse withstand voltage u_{imp}	4 kV		
Rated frequency	50-60 Hz		
Product service life	> 5000 hours		
Signal output			
Sound level	≥ 80 dB /10 cm		
Audio frequency	6.7 kHz		
Pulsating frequency of light and sound output	2 Hz		

Compact range

Technical data

Illuminated pushbuttons CP

Color	Current		Illuminance of flush cap		Illuminance of extended cap		Anti-inductive peak voltage	Main wavelength	Color temperature
	mA Min.	Max.	lx Min.	Max.	lx Min.	Max.			
Voltage range 24 V AC / DC									
● Red	8.5	11.5	150	600	120	400	5	620 ... 625	–
● Green	8.0	11.0	200	800	150	500	5	515 ... 520	–
● Yellow	8.5	11.5	200	800	120	400	5	585 ... 590	–
● Blue	8.5	10.5	200	500	200	400	5	465 ... 470	–
○ Clear	8.5	10.5	620	1000	360	700	5	–	8000 ... 12000
Voltage range 110 ... 130 V AC / DC									
● Red	6.5	9.0	150	600	100	350	15	620 ... 625	–
● Green	6.5	9.0	150	600	100	350	15	515 ... 520	–
● Yellow	6.5	9.0	150	600	100	350	15	585 ... 590	–
● Blue	6.5	9.0	200	450	180	300	15	465 ... 470	–
○ Clear	6.5	9.0	520	860	300	600	15	–	8000 ... 12000
Voltage range 230 V AC / DC									
● Red	4.0	6.0	150	600	120	400	15	620 ... 625	–
● Green	4.0	6.0	150	900	150	500	15	515 ... 520	–
● Yellow	4.0	6.0	150	600	150	500	15	585 ... 590	–
● Blue	4.0	6.0	250	500	250	400	15	465 ... 470	–
○ Clear	4.0	6.0	650	1050	380	720	15	–	8000 ... 12000

Note: The testing distance of illuminance is 2 mm between top lens and sensor surface. Clean test environment, supply voltage at 50 / 60 Hz with harmonized wave and without high frequency.

Compact range

Technical data

Pilot light CL2

Color	Current		Illuminance		Anti-inductive peak voltage V	Main wavelength Nm	Color temperature K
	mA Min.	Max.	lx Min.	Max.			
Voltage range 6.3 V DC							
● Red	13	16	45	250	2	620 ... 625	–
● Green	9.5	12.5	114	245	2	515 ... 520	–
● Yellow	13	16	65	210	2	585 ... 590	–
● Blue	9.5	12.5	8	35	2	465 ... 470	–
○ Clear	10	13	300	850	2	–	8000 ... 12000
Voltage range 12 V DC							
● Red	14	16	100	280	2	620 ... 625	–
● Green	12	14	165	310	2.5	515 ... 520	–
● Yellow	13.5	16	85	230	2.5	585 ... 590	–
● Blue	12	14	10	50	2.5	465 ... 470	–
○ Clear	12.5	14.5	480	850	2.5	–	8000 ... 12000
Voltage range 24 V AC / DC							
● Red	14	16	75	240	6	620 ... 625	–
● Green	13.5	15	120	320	6	515 ... 520	–
● Yellow	14	16	55	230	6	585 ... 590	–
● Blue	13.5	15	8	30	6	465 ... 470	–
○ Clear	13.5	15	450	700	6	–	8000 ... 12000
Voltage range 48 ... 60 V AC / DC							
● Red	14.5	16.5	75	200	7	620 ... 625	–
● Green	14.5	16.5	140	340	7	515 ... 520	–
● Yellow	14.5	16.5	55	330	7	585 ... 590	–
● Blue	14.5	16.5	10	45	7	465 ... 470	–
○ Clear	14.5	16.5	550	800	7	–	8000 ... 12000
Voltage range 110 ... 130 V AC							
● Red	14.5	17	85	340	20	620 ... 625	–
● Green	14.5	17	95	400	20	515 ... 520	–
● Yellow	14.5	17	85	250	20	585 ... 590	–
● Blue	14.5	17	8	30	20	465 ... 470	–
○ Clear	14.5	17	400	700	20	–	8000 ... 12000
Voltage range 110 ... 130 V DC							
● Red	7.5	9.5	40	110	20	620 ... 625	–
● Green	7.5	9.5	80	250	20	515 ... 520	–
● Yellow	7.5	9.5	45	165	20	585 ... 590	–
● Blue	7.5	9.5	6	35	20	465 ... 470	–
○ Clear	7.5	9.5	300	400	20	–	8000 ... 12000

Note: The testing distance of illuminance is 2 mm between top lens and sensor surface. Clean test environment, supply voltage at 50 / 60 Hz with harmonized wave and without high frequency.

Compact range

Technical data

Pilot light CL2

Color	Current		Illuminance		Anti-inductive peak voltage	Main wavelength	Color temperature
	mA Min.	Max.	lx Min.	Max.	V	Nm	K
Voltage range 220 V DC							
● Red	5	6	15	85	20	620 ... 625	–
● Green	5	6	55	180	20	515 ... 520	–
● Yellow	5	6	15	115	20	585 ... 590	–
● Blue	5	6	5	35	20	465 ... 470	–
○ Clear	5	6	200	320	20	–	8000 ... 12000
Voltage range 230 V AC							
● Red	14.5	17	85	340	30	620 ... 625	–
● Green	14.5	17	95	400	35	515 ... 520	–
● Yellow	14.5	17	85	235	35	585 ... 590	–
● Blue	14.5	17	8	30	35	465 ... 470	–
○ Clear	14.5	17	400	700	35	–	8000 ... 12000
Voltage range 380 ... 415 V AC							
● Red	14.5	17	85	340	55	620 ... 625	–
● Green	14.5	17	95	400	65	515 ... 520	–
● Yellow	14.5	17	100	270	65	585 ... 590	–
● Blue	14.5	17	8	30	65	465 ... 470	–
○ Clear	14.5	17	400	700	65	–	8000 ... 12000
Voltage range 230 V AC high anti-inductive voltage							
● Red	14.5	17	55	255	60	620 ... 625	–
● Green	14.5	17	60	265	80	515 ... 520	–
● Yellow	14.5	17	45	210	70	585 ... 590	–
● Blue	14.5	17	5	25	80	465 ... 470	–
○ Clear	14.5	17	280	490	80	–	8000 ... 12000

Note: The testing distance of illuminance is 2 mm between top lens and sensor surface. Clean test environment, supply voltage at 50 / 60 Hz with harmonized wave and without high frequency.

Compact range

Technical data

Buzzer CB

Color	Light and sound output	Current			Illuminance		Sound press level (dB/10cm)
		mA Min.		Max.	lx Min.	Max.	
Voltage range 24 V AC / DC							
● Red	Pulsation	63	75	150	450		≥90
● Yellow	Pulsation	63	75	70	300		≥90
● Green	Continuous	43	53	150	600		≥90
● Black	Pulsation	58	72	–	–		≥90
● Black	Continuous	40	50	–	–		≥90
Voltage range 110 ... 30 V AC							
● Red	Pulsation	71	81	70	300		≥90
● Yellow	Pulsation	72	87	150	450		≥90
● Green	Continuous	50	60	150	600		≥90
● Black	Pulsation	42	54	–	–		≥90
● Black	Continuous	40	50	–	–		≥90
Voltage range 110 ... 130 V DC							
● Red	Pulsation	13	18	5	50		≥80
● Yellow	Pulsation	13	18	5	50		≥80
● Green	Continuous	13	18	15	100		≥80
● Black	Pulsation	13	18	–	–		≥80
● Black	Continuous	13	18	–	–		≥80
Voltage range 230 V AC							
● Red	Pulsation	70	84	150	450		≥90
● Yellow	Pulsation	72	82	70	300		≥90
● Green	Continuous	50	62	350	900		≥90
● Black	Pulsation	42	54	–	–		≥90
● Black	Continuous	43	53	–	–		≥90

Note: The testing distance of illuminance is 2 mm between top lens and sensor surface. Clean test environment, supply voltage at 50 / 60 Hz with harmonized wave and without high frequency.
Fluctuation of rated voltage: -10% to +10%.

Compact range

Drilling plan

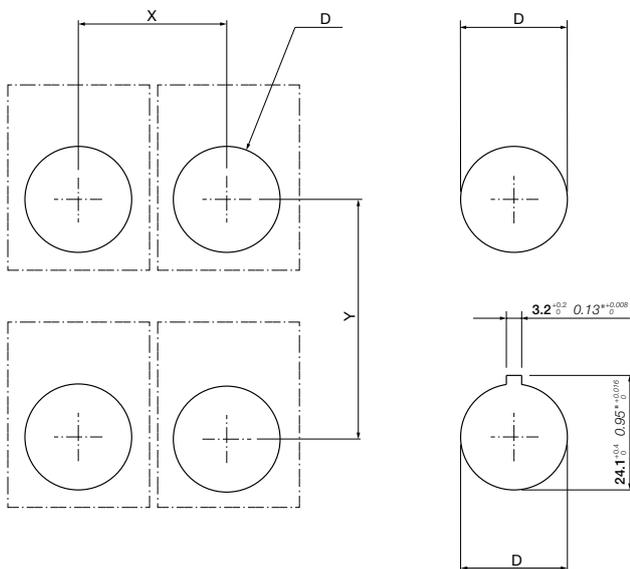

Type	Description	X	Y	D		Panel thickness
				Ø mm	inch	
CP, CL, CSS, CB	Pushbutton, Pilot light, Selector switch, Buzzer	31 1.22"	50 1.97"	Ø 22.3 ^{+0.4} ₀	0.88" ^{+0.016} ₀	1.5 0.06" - 6 0.24"
CP, CL, CSS, CB	Pushbutton, Pilot light, Selector switch, Buzzer (with legend plate)	31 1.22"	55 2.17"	Ø 22.3 ^{+0.4} ₀	0.88" ^{+0.016} ₀	1.5 0.06" - 6 0.24"
CPM, CP6, CE	Mushroom pushbutton, Heavy duty pushbutton	41 1.61"	55 2.17"	Ø 22.3 ^{+0.4} ₀	0.88" ^{+0.016} ₀	1.5 0.06" - 6 0.24"

Pilot devices

Enclosures and assembled stations

Ordering details

123	Plastic enclosures for modular and compact range
124	Accessories for plastic enclosures
125	LED blocks for rear mounting
127	Legend plate holders and inserts
128	Legend plate for plastic enclosures MEP and CEP
129	Selector switches for vertical mounting
130	Assembled stations
131	Assembled stations - Dimensions

Enclosures



Plastic enclosure for modular and compact

This enclosure can fit both modular and compact operators with the unique possibility to mount up to 5 contact blocks assigned to one operator.

Degree of protection: IP66 UL/NEMA type 1, 3R, 4, 4X, 12, 13



Compact plastic enclosure

The compact enclosure is one of the smallest on the market intended for compact operators.

Degree of protection: IP66, 67, 69K UL/NEMA type 1, 3R, 4, 4X, 12, 13



Metal enclosure

Metal line is made in addition to our plastic lines when metal is required. Featuring a high protection degree and large installation space.

Degree of protection: IP66, 67, 69K

Assembled stations

We can also offer some of the most common assembled stations as a standard in combination with both modular and compact range.

Enclosures

Plastic enclosures for modular and compact range



Description

When ordering complete enclosures:

- Select operators (modular or compact)
- For modular, select contact blocks and LED blocks for rear mounting (in accessories section)
- Per operator select between
 - One legend plate
 - One shroud (only for 1-seat)
 - One spacer
 - No accessory (only for compact range)
- Select cable gland

UL-listed applications: For end of line use only

According to the safety of machinery EN / ISO 13850 emergency stop pushbuttons should be mounted on yellow background

Description	Color	Holes for cable gland	Type	Order code	Pkg qty	Weight (1 pce) kg
Plastic enclosures						
Empty plastic enclosures with stainless steel screws for modular and compact range						
1-seat	Dark grey / light grey	M20 and Pg 13.5/ Pg16 and (M20)	MEP1-0	1SFA611811R1000	1	0.15
1-seat	Yellow / light grey	M20 and Pg 13.5/ Pg16 and (M20)	MEPY1-0	1SFA611821R1000	1	0.15
2-seat	Dark grey / light grey	M20 and Pg 13.5/ Pg16 and (M20)	MEP2-0	1SFA611812R1000	1	0.17
3-seat	Dark grey / light grey	M20 and Pg 13.5/ Pg16 and (M20)	MEP3-0	1SFA611813R1000	1	0.20
4-seat	Dark grey / light grey	M25/Pg 16 and (M20)	MEP4-0	1SFA611814R1000	1	0.23
6-seat	Dark grey / light grey	M25/Pg 16 and (M20)	MEP6-0	1SFA611816R1000	1	0.30

Shrouds

To be mounted on MEP 1-seat enclosures or on panels

Yellow	MA1-8053	1SFA611920R8053	1	0.02
Grey	MA1-8128	1SFA611920R8128	1	0.02

Compact plastic enclosures

Empty enclosure for compact range

1-seat	Yellow / light grey	M20 and Pg 13.5/ Pg16 and (M20)	CEPY1-0	1SFA619821R1000	1	0.072
1-seat	Dark grey / light grey	M20 and Pg 13.5/ Pg16 and (M20)	CEP1-0	1SFA619811R1000	1	0.072

Shrouds

To be mounted on CEP-series of enclosures or on panel

Yellow	CA1-8053	1SFA619920R8053	1	0.016
Grey	CA1-8054	1SFA619920R8054	1	0.016

Enclosures

Accessories for plastic enclosures



MCB-10B



MCB-11B



MCB-02B



MCB-01BG

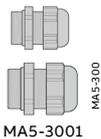

MA5-3001



MA1-8130



MA1-8136

Description

To be used with MEP plastic enclosure or on DIN-rail

Description	Contacts	Type	Order code	Pkg qty	Weight (1 pce)
					kg



Contact blocks for rear mounting

Single contact block	1 0	MCB-10B	1SFA611610R2001	10	0.013
	0 1	MCB-01B	1SFA611610R2010	10	0.013
Double contact block	1 1	MCB-11B	1SFA611610R2011	10	0.026
	2 0	MCB-20B	1SFA611610R2002	10	0.026
	0 2	MCB-02B	1SFA611610R2020	10	0.026

Contact blocks with gold plated contacts

Single contact block	1 0	MCB-10BG	1SFA611610R2101	10	0.013
	0 1	MCB-01BG	1SFA611610R2110	10	0.013

Cable glands

Grey plastic, threaded outer sleeve with sealing ring included. Nut not included.

M25	MA5-3001	1SFA611925R3001	10	0.015
M20	MA5-3002	1SFA611925R3002	10	0.015
PG 13.5	MA5-3006	1SFA611925R3006	10	0.010
PG 16	MA5-3007	1SFA611925R3007	10	0.015

Nuts

Grey plastic, for cable glands above

M25	MA5-3003	1SFA611925R3003	10	0.005
M20	MA5-3004	1SFA611925R3004	10	0.005
PG 13.5	MA5-3008	1SFA611925R3008	10	0.001
PG 16	MA5-3009	1SFA611925R3009	10	0.001

Sealing ring for operator hole

For plastic enclosure	MA1-8150	1SFA611920H8150	100	0.001
-----------------------	----------	-----------------	-----	-------

Spacers

Needed when legend plates or shrouds are not used in plastic enclosures with rear mounted contact block. 1 mm thick.

Spacer	-	SK615516-1	10	0.002
Spacer for modular MPMP/T	KA1-8045	1SFA616920R8045	10	0.004
Spacer with rotation stop	MA1-8160	1SFA611920R8160	10	0.003

Blanking plugs

Grey	MA1-8129	1SFA611920R8129	10	0.005
Black	MA1-8130	1SFA611920R8130	10	0.005
Light grey	MA1-8136	1SFA611920R8136	10	0.005

Adaptor

PG 16/M20	MA5-3010	1SFA611925R3010	10	0.010
-----------	----------	-----------------	----	-------

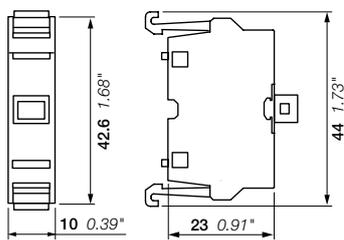

MCB

Dimensions (mm, inches)

Enclosures

LED blocks for rear mounting



MLBL-00BW

1SFC15105650201

Description

To be used in MEP plastic enclosure or on DIN-rail

Color	Rated current mA	Wave-length nm	Lumi-nance mcd	Type	Order code	Pkg qty	Weight (1 pce) kg
Rated voltage 12 V DC (1)							
● Red	12.0	620	320	MLBL-00BR	1SFA611621R2001	10	0.012
● Green	9.3	520	1500	MLBL-00BG	1SFA611621R2002	10	0.012
● Yellow	12.0	588	380	MLBL-00BY	1SFA611621R2003	10	0.012
● Blue	9.5	468	450	MLBL-00BL	1SFA611621R2004	10	0.012
○ White	9.3	(2)	600	MLBL-00BW	1SFA611621R2005	10	0.012
Rated voltage 24 V AC / DC (1)							
● Red	9.9	620	250	MLBL-01BR	1SFA611621R2011	10	0.012
● Green	9.2	520	1500	MLBL-01BG	1SFA611621R2012	10	0.012
● Yellow	9.9	588	250	MLBL-01BY	1SFA611621R2013	10	0.012
● Blue	9.3	468	450	MLBL-01BL	1SFA611621R2014	10	0.012
○ White	9.2	(2)	600	MLBL-01BW	1SFA611621R2015	10	0.012
Rated voltage 48 V AC / DC (1)							
● Red	10.0	620	260	MLBL-02BR	1SFA611621R2021	10	0.012
● Green	9.7	520	1500	MLBL-02BG	1SFA611621R2022	10	0.012
● Yellow	10.0	588	300	MLBL-02BY	1SFA611621R2023	10	0.012
● Blue	9.7	468	450	MLBL-02BL	1SFA611621R2024	10	0.012
○ White	9.7	(2)	600	MLBL-02BW	1SFA611621R2025	10	0.012
Rated voltage 60 V AC / DC (1)							
● Red	13.0	620	350	MLBL-03BR	1SFA611621R2031	10	0.012
● Green	12.7	520	2000	MLBL-03BG	1SFA611621R2032	10	0.012
● Yellow	13.0	588	400	MLBL-03BY	1SFA611621R2033	10	0.012
● Blue	12.7	468	550	MLBL-03BL	1SFA611621R2034	10	0.012
○ White	12.7	(2)	750	MLBL-03BW	1SFA611621R2035	10	0.012
Rated voltage 110 ... 130 V AC							
● Red	8.6	620	200	MLBL-04BR	1SFA611621R2041	10	0.012
● Green	8.5	520	1200	MLBL-04BG	1SFA611621R2042	10	0.012
● Yellow	8.6	588	250	MLBL-04BY	1SFA611621R2043	10	0.012
● Blue	7.0	468	400	MLBL-04BL	1SFA611621R2044	10	0.012
○ White	7.0	(2)	500	MLBL-04BW	1SFA611621R2045	10	0.012
Rated voltage 110 ... 130 V DC (1)							
● Red	9.9	620	250	MLBL-05BR	1SFA611621R2051	10	0.012
● Green	9.8	520	1500	MLBL-05BG	1SFA611621R2052	10	0.012
● Yellow	9.9	588	300	MLBL-05BY	1SFA611621R2053	10	0.012
● Blue	9.8	468	450	MLBL-05BL	1SFA611621R2054	10	0.012
○ White	9.8	(2)	600	MLBL-05BW	1SFA611621R2055	10	0.012
Rated voltage 220 V DC (1)							
● Red	8.0	620	180	MLBL-06BR	1SFA611621R2061	10	0.012
● Green	8.0	520	110	MLBL-06BG	1SFA611621R2062	10	0.012
● Yellow	8.0	588	200	MLBL-06BY	1SFA611621R2063	10	0.012
● Blue	8.0	468	450	MLBL-06BL	1SFA611621R2064	10	0.012
○ White	8.0	(2)	600	MLBL-06BW	1SFA611621R2065	10	0.012

Note:

(1) Care should be taken for DC supply where + and - must be correctly connected. This is marked X1 (+) and X2 (-) on the product.

(2) X=0.31, Y=0.32 according to the ICI Chromaticity diagram.

For technical data, please refer to modular range section.

Enclosures

LED blocks for rear mounting



MLBL-07BW

1SFC15105650201

Description

To be used in MEP plastic enclosure or on DIN-rail

Color	Rated current mA	Wave-length nm	Lumi-nance mcd	Type	Order code	Pkg qty	Weight (1 pce) kg
Rated voltage 230 V AC							
● Red	9.5	620	250	MLBL-07BR	1SFA611621R2071	10	0.012
● Green	9.4	520	1500	MLBL-07BG	1SFA611621R2072	10	0.012
● Yellow	9.5	588	300	MLBL-07BY	1SFA611621R2073	10	0.012
● Blue	8.2	468	450	MLBL-07BL	1SFA611621R2074	10	0.012
○ White	8.2	(2)	600	MLBL-07BW	1SFA611621R2075	10	0.012
Rated voltage 380 V AC							
● Red	10.2	620	250	MLBL-08BR	1SFA611621R2081	10	0.012
● Green	10.2	520	1500	MLBL-08BG	1SFA611621R2082	10	0.012
● Yellow	10.2	582	300	MLBL-08BY	1SFA611621R2083	10	0.012
● Blue	9.1	468	450	MLBL-08BL	1SFA611621R2084	10	0.012
○ White	9.1	(2)	600	MLBL-08BW	1SFA611621R2085	10	0.012
Rated voltage 415 V AC							
● Red	11.2	620	280	MLBL-09BR	1SFA611621R2091	10	0.012
● Green	11.2	520	1800	MLBL-09BG	1SFA611621R2092	10	0.012
● Yellow	11.2	588	350	MLBL-09BY	1SFA611621R2093	10	0.012
● Blue	9.9	468	500	MLBL-09BL	1SFA611621R2094	10	0.012
○ White	9.9	(2)	650	MLBL-09BW	1SFA611621R2095	10	0.012

Note:

(1) Care should be taken for DC supply where + and - must be correctly connected. This is marked X1 (+) and X2 (-) on the product.

(2) X=0.31, Y=0.32 according to the ICI Chromaticity diagram.

For technical data, please refer to modular range section.

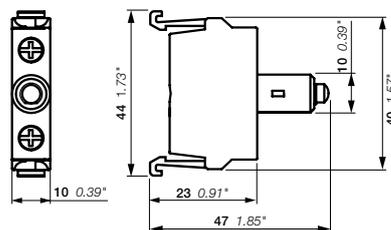

MLBL

Dimensions (mm, inches)

Enclosures

Legend plate holders and inserts



MA6-1060



MA6-1061

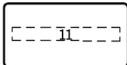

1-position insert

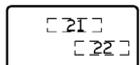

2-position insert

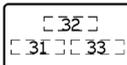

3-position insert

Description

For Ø 22 mm operator, can be used with MEP plastic enclosures, laser marked with text or symbols. Inserts are made of plastic and aluminium laminate.

Description	Type	Order code	Pkg qty	Weight (1pce) kg
-------------	------	------------	---------	------------------

Legend plate holder

Grey plastic	MA6-1060	1SFA611930R1060	10	0.002
--------------	----------	-----------------	----	-------

Insert

Without text or symbol	MA6-1061	1SFA611930R1061	10	0.001
------------------------	----------	-----------------	----	-------

1-position inserts

O	MA6-1062	1SFA611930R1062	10	0.001
I	MA6-1063	1SFA611930R1063	10	0.001
II	MA6-1064	1SFA611930R1064	10	0.001
→	MA6-1065	1SFA611930R1065	10	0.001
→	MA6-1130	1SFA611930R1130	10	0.001
→ →	MA6-1131	1SFA611930R1131	10	0.001
Close	MA6-1132	1SFA611930R1132	10	0.001
Open	MA6-1133	1SFA611930R1133	10	0.001
On	MA6-1134	1SFA611930R1134	10	0.001
Off	MA6-1135	1SFA611930R1135	10	0.001
Fast	MA6-1136	1SFA611930R1136	10	0.001
Slow	MA6-1137	1SFA611930R1137	10	0.001
Down	MA6-1138	1SFA611930R1138	10	0.001
Up	MA6-1139	1SFA611930R1139	10	0.001
Start	MA6-1140	1SFA611930R1140	10	0.001
Stop	MA6-1141	1SFA611930R1141	10	0.001
Forward	MA6-1152	1SFA611930R1152	10	0.001
Reverse	MA6-1153	1SFA611930R1153	10	0.001

2-position inserts for selector switches

Pos.21	Pos.22				
O	I	MA6-1170	1SFA611930R1170	10	0.001
I	II	MA6-1171	1SFA611930R1171	10	0.001
→	→ →	MA6-1172	1SFA611930R1172	10	0.001
Off	On	MA6-1173	1SFA611930R1173	10	0.001
Stop	Start	MA6-1174	1SFA611930R1174	10	0.001
Low	High	MA6-1175	1SFA611930R1175	10	0.001
Slow	Fast	MA6-1176	1SFA611930R1176	10	0.001
Close	Open	MA6-1177	1SFA611930R1177	10	0.001
Jog	Run	MA6-1178	1SFA611930R1178	10	0.001
Hand	Auto	MA6-1179	1SFA611930R1179	10	0.001

3-position inserts for selector switches

Pos.31	Pos.32	Pos.33				
←	O	→	MA6-1190	1SFA611930R1190	10	0.001
→	O	→ →	MA6-1191	1SFA611930R1191	10	0.001
I	O	II	MA6-1192	1SFA611930R1192	10	0.001
Hand	O	Auto	MA6-1193	1SFA611930R1193	10	0.001
Slow	Off	Fast	MA6-1194	1SFA611930R1194	10	0.001

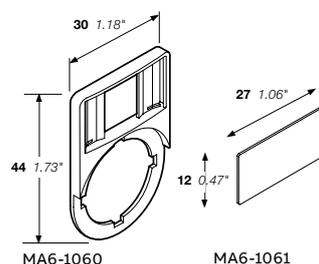

Dimensions (mm, inches)

Enclosures

Legend plates for plastic enclosures MEP and CEP

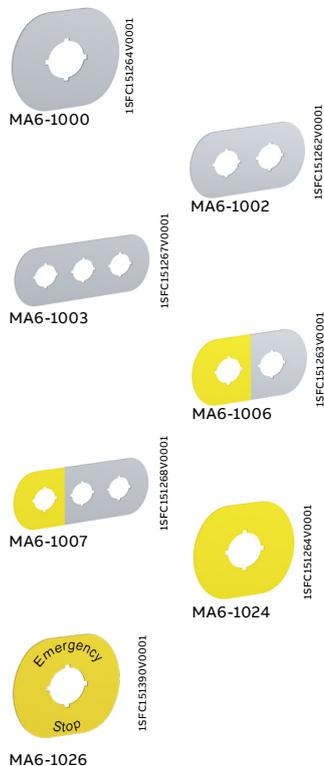

Legend plates for MEP plastic enclosures

For Ø 22 mm operator, plastic and aluminum laminate with adhesive back. Combine the emergency stop with the yellow legend plates without text to conform with safety of machinery standard EN/ISO 13850.

Description	Text symbol	Type	Order code	Pkg qty	Weight (1pce) kg
Aluminum and plastic laminate					
1-seat	without text	MA6-1000	1SFA611930R1000	10	0.004
2-seat	without text	MA6-1002	1SFA611930R1002	10	0.006
3-seat	without text	MA6-1003	1SFA611930R1003	10	0.008
4-seat	without text	MA6-1004	1SFA611930R1004	10	0.010
6-seat	without text	MA6-1005	1SFA611930R1005	10	0.012
1-seat	O	MA6-1012	1SFA611930R1012	10	0.004
1-seat	I	MA6-1013	1SFA611930R1013	10	0.004
2-seat	O I	MA6-1014	1SFA611930R1014	10	0.006
3-seat	O II	MA6-1015	1SFA611930R1015	10	0.008
3-seat	I O II	MA6-1016	1SFA611930R1016	10	0.008

Pos. 1 yellow plastic and aluminium laminate

2-seat	without text	MA6-1006	1SFA611930R1006	10	0.006
3-seat	without text	MA6-1007	1SFA611930R1007	10	0.008
4-seat	without text	MA6-1008	1SFA611930R1008	10	0.010
6-seat	without text	MA6-1009	1SFA611930R1009	10	0.012

Emergency stop legend plates for 1-seat enclosures

For horizontally mounted enclosures. Yellow plastic laminate. 66 x 59 mm.

Without text	MA6-1024	1SFA611930R1024	10	0.004
Nöd Stopp	MA6-1025	1SFA611930R1025	10	0.004
Emergency stop	MA6-1026	1SFA611930R1026	10	0.004
Not Aus	MA6-1027	1SFA611930R1027	10	0.004
ARRET D'URGENCE	MA6-1028	1SFA611930R1028	10	0.004
Hätäseis	MA6-1029	1SFA611930R1029	10	0.004

For vertically mounted enclosures. Yellow plastic laminate. 59 x 66 mm.

Nöd Stopp	MA6-1100	1SFA611930R1100	10	0.004
Emergency stop	MA6-1101	1SFA611930R1101	10	0.004
Not Aus	MA6-1102	1SFA611930R1102	10	0.004
ARRET D'URGENCE	MA6-1103	1SFA611930R1103	10	0.004
Hätäseis	MA6-1104	1SFA611930R1104	10	0.004

Legend plates for CEP plastic enclosures

For Ø 22 mm operator

Description	Text symbol	Type	Order code	Pkg qty	Weight (1pce) kg
Emergency stop legend plates					
Black text on yellow aluminum plate Ø 59 mm					
Without text		CA6-1024	1SFA619930R1024	10	0.004
Emergency stop		CA6-1026	1SFA619930R1026	10	0.004
Not Aus		CA6-1027	1SFA619930R1027	10	0.004

Enclosures

Selector switches for vertical mounting



Description

When ordering complete vertically mounted enclosures:

- Select selector switches for vertical mounting
- Select contact blocks and LED blocks for rear mounting.

Per operator select between:

- One legend plate for vertical enclosures
- One spacer

Select cable gland.

Description	Color	Type	Order code	Pkg qty	Weight (1pce) kg
-------------	-------	------	------------	---------	------------------

2-position selector switch

Short handle, non-illuminated

	● Black	M2SSV1-10B	1SFA611220R1006	10	0.015
	● Black	M2SSV2-10B	1SFA611221R1006	10	0.015
	● Black	M2SSV3-10B	1SFA611222R1006	10	0.015

3-position selector switch

Short handle, non-illuminated

	● Black	M3SSV1-10B	1SFA611230R1006	10	0.015
	● Black	M3SSV2-10B	1SFA611231R1006	10	0.015
	● Black	M3SSV3-10B	1SFA611232R1006	10	0.015

Contacts actuated

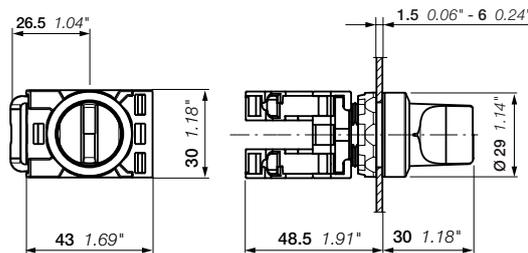
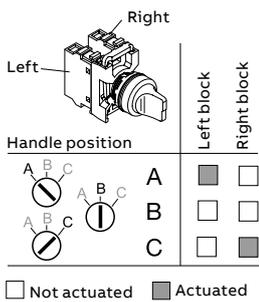

M2SSV, M3SSV

Dimensions (mm, inches)

Enclosures

Assembled stations



MEPY1-1042

1SFC151415V0001



CEPY1-2001

1SFC151387V0001



MEP2-1001

1SFC151273V0001

Description

Assembled enclosures with emergency stop pushbuttons, yellow / light grey color designed according to the Safety of machinery standard EN/ISO 13850 for emergency stops.

Release method	Contacts	Type	Order code	Pkg qty	Weight (1 pce)
					kg

1-seat plastic enclosures with 40 mm modular emergency stop pushbuttons

Yellow / light grey color

Twist release	0 2	MEPY1-1042	1SFA611821R1042	1	0.240
Twist release	1 2	MEPY1-1041	1SFA611821R1041	1	0.250
Pull release	0 2	MEPY1-1035	1SFA611821R1035	1	0.466
Twist release with plastic legend plate "Emergency stop"	0 2	MEPY1-1040	1SFA611821R1040	1	0.240

1-seat plastic enclosures with 40 mm compact emergency stop pushbuttons

Yellow / light grey color

Twist release	0 2	CEPY1-1001	1SFA619821R1001	1	0.108
Pull release	0 2	CEPY1-1002	1SFA619821R1002	1	0.108
Key release	1 1	CEPY1-1006	1SFA619821R1006	1	0.105
Twist release, yellow shroud	0 2	CEPY1-2001	1SFA619821R2001	1	0.124
Pull release, yellow shroud	0 2	CEPY1-2002	1SFA619821R2002	1	0.124

1-seat plastic enclosures with 40 mm compact machine stop pushbuttons

Dark grey / light grey color

Twist release	1 1	CEP1-1001	1SFA619811R1001	1	0.108
Pull release	1 1	CEP1-1002	1SFA619811R1002	1	0.108
Twist release, grey shroud	1 1	CEP1-2001	1SFA619811R2001	1	0.124
Pull release, grey shroud	1 1	CEP1-2002	1SFA619811R2002	1	0.124

2-seat plastic enclosure with modular pushbuttons

Dark grey / light grey

Two flush pushbuttons, momentary, black bezel

● Green	● Red		MEP2-1001	1SFA611812R1001	1	0.220
1 NO	1 NC					
I	O					

Enclosures

Dimensions

MEP plastic enclosures

1-seat

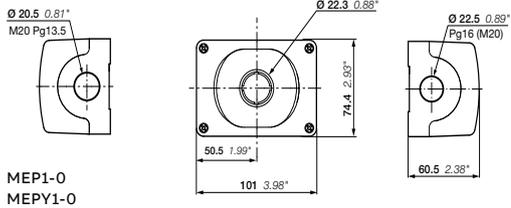

2 seats

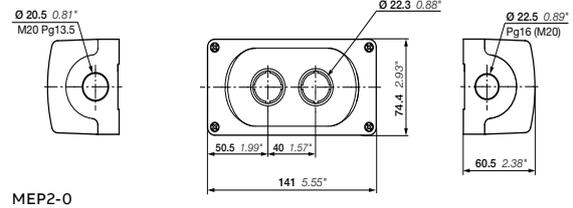

3-seats

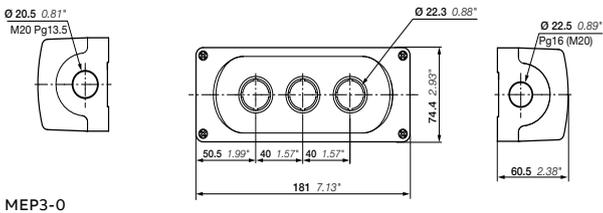

4-seats

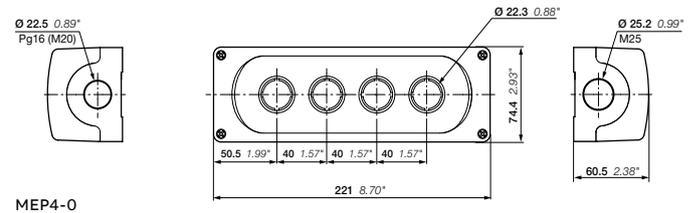

6-seats

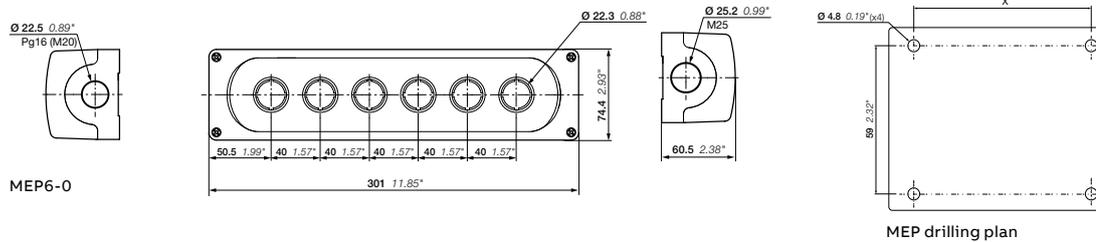

Type	X
1-seat	72 mm / 2.83"
2-seats	112 mm / 4.41"
3-seats	152 mm / 5.98"
4-seats	192 mm / 7.56"
6-seats	272 mm / 10.71"

MEP drilling plan

CEP plastic enclosure for compact range

1-seat

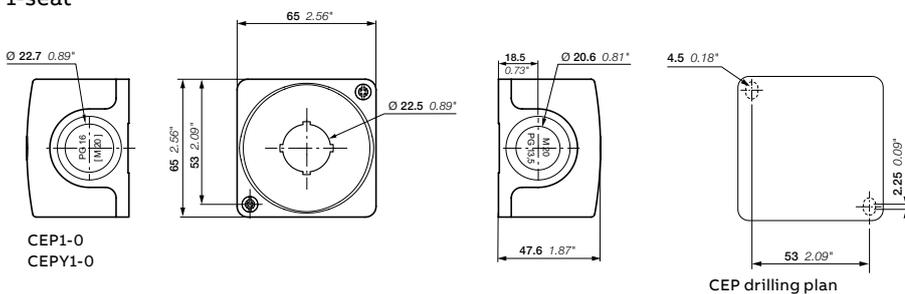

Legend plates and text caps

Ordering details

135	Legend plate holder with inserts
136	Legend plates for emergency stop
137	Legend plates for panels
138	Text caps for illuminated pushbuttons and pilot lights

Legend plates and text caps



ABB offers a wide range of alternatives to label our products. Choose between marked aluminium legend plates, insert holders with a wide range of marked inserts or text caps to mount under the lens of the pilot device.

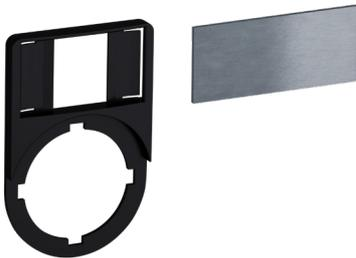

Legend plates and text caps

Legend plate holder with inserts

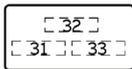
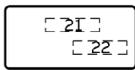
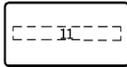

Description

For Ø 22 mm operators installed in panel, laser marked with text or symbols. Inserts made of plastic and aluminium laminate.

Description	Type	Order code	Pkg qty	Weight (1pce) kg
-------------	------	------------	---------	------------------

Legend plate holder

Black plastic	KA1-8120	1SFA616920R8120	100	0.002
---------------	----------	-----------------	-----	-------

Insert

Without text or symbol	KA1-8121	1SFA616920R8121	100	0.001
------------------------	----------	-----------------	-----	-------

1-position inserts

O	MA6-1032	1SFA611930R1032	10	0.001
I	MA6-1033	1SFA611930R1033	10	0.001
→	MA6-1034	1SFA611930R1034	10	0.001
→ →	MA6-1035	1SFA611930R1035	10	0.001
Close	MA6-1036	1SFA611930R1036	10	0.001
Open	MA6-1037	1SFA611930R1037	10	0.001
On	MA6-1038	1SFA611930R1038	10	0.001
Off	MA6-1039	1SFA611930R1039	10	0.001
Fast	MA6-1040	1SFA611930R1040	10	0.001
Slow	MA6-1041	1SFA611930R1041	10	0.001
Down	MA6-1042	1SFA611930R1042	10	0.001
Up	MA6-1043	1SFA611930R1043	10	0.001
Start	MA6-1044	1SFA611930R1044	10	0.001
Stop	MA6-1045	1SFA611930R1045	10	0.001
Reset	MA6-1047	1SFA611930R1047	10	0.001
Run	MA6-1054	1SFA611930R1054	10	0.001
Fault	MA6-1058	1SFA611930R1058	10	0.001
Trip	MA6-1118	1SFA611930R1118	10	0.001
	MA6-1210	1SFA611930R1210	10	0.001

2-position inserts for selector switches

Pos. 21	Pos. 22			
O	I	MA6-1070	1SFA611930R1070	10 0.001
I	II	MA6-1071	1SFA611930R1071	10 0.001
Off	On	MA6-1073	1SFA611930R1073	10 0.001
Stop	Start	MA6-1074	1SFA611930R1074	10 0.001
Low	High	MA6-1075	1SFA611930R1075	10 0.001
Slow	Fast	MA6-1076	1SFA611930R1076	10 0.001
Close	Open	MA6-1077	1SFA611930R1077	10 0.001
Hand	Auto	MA6-1079	1SFA611930R1079	10 0.001

3-position inserts for selector switches

Pos.31	Pos.32	Pos.33		
←	O	→	MA6-1080	1SFA611930R1080 10 0.001
I	O	II	MA6-1082	1SFA611930R1082 10 0.001
Hand	O	Auto	MA6-1083	1SFA611930R1083 10 0.001
Slow	Off	Fast	MA6-1084	1SFA611930R1084 10 0.001
Man		Auto	MA6-1085	1SFA611930R1085 10 0.001
Man	Off	Auto	MA6-1086	1SFA611930R1086 10 0.001
O		I	MA6-1087	1SFA611930R1087 10 0.001

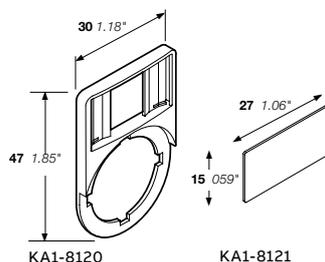

Dimensions (mm, inches)

Legend plates and text caps

Legend plates for emergency stop



1SFA616915R1005

1SFC151388V0001



SK615546-2

1SFC151386V0001

Description

For Ø 22 mm operators installed in panel. Combine the emergency stops with the yellow legend plates and black text to conform with the Safety machinery standard EN/ISO 13850.

Legend plates made of laminate have adhesive back.

Description	Type	Order code	Pkg qty	Weight (1pce) kg
Plastic Ø 70mm				
Without text	KTC15-1038	1SFA616915R1038	10	0.003
Emergency stop	KTC15-1005	1SFA616915R1005	10	0.003
Not Aus	KTC15-6005	1SFA616915R6005	10	0.003
Aluminium Ø 70 mm				
Without text	–	SK615546-8	10	0.010
Nöd Stopp	–	SK615546-1	10	0.010
Emergency stop	–	SK615546-2	10	0.010
Not Aus	–	SK615546-3	10	0.010
ARRET D'URGENCE	–	SK615546-4	10	0.010
HÄTÄSEIS	–	SK615546-5	10	0.010
PARADA DE EMERGENCIA	–	SK615546-6	10	0.010
Emergency stop NOT AUS ARRET D'URGENCE	–	SK615546-13	10	0.010
Noodstop	–	SK615546-15	10	0.010
Aluminum laminate rectangular 59 x 39.5 mm				
Without text	MA6-1010	1SFA611930R1010	10	0.005
Nöd stopp	MA6-1017	1SFA611930R1017	10	0.005
Not haus	MA6-1018	1SFA611930R1018	10	0.005
Emergency stop	MA6-1019	1SFA611930R1019	10	0.005
ARRET D'URGENCE	MA6-1020	1SFA611930R1020	10	0.005
Hätäseis	MA6-1021	1SFA611930R1021	10	0.005
PARADA DE EMERGENCIA	MA6-1022	1SFA611930R1022	10	0.005
Plastic laminate rectangular 59 x 39.5 mm				
Without text	MA6-1011	1SFA611930R1011	10	0.002
Emergency stop	MA6-1023	1SFA611930R1023	10	0.002

Legend plates and text caps

Legend plates for panels

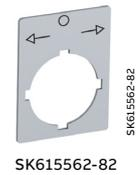
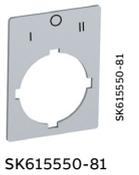
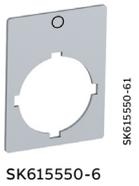

Description

For Ø 22 mm operators, made of silver-grey aluminium.

Type	Order code	Pkg qty	Weight (1pce) kg
Without text			
Legend plate height 39 mm	MA16-1000 1SFA611940R1000	10	0.002
Legend plate height 44 mm	MA16-1001 1SFA611940R1001	10	0.002

1-position engraved for selector switches and pushbuttons

Legend plate height 39 mm

O	–	SK615550-61	10	0.002
I	–	SK615550-62	10	0.002
→	–	SK615562-12	10	0.002
Close	–	SK615552-13	10	0.002
Down	–	SK615552-14	10	0.002
Emergency stop	–	SK615552-15	10	0.002
Fast	–	SK615552-16	10	0.002
Forward	–	SK615552-17	10	0.002
In	–	SK615550-29	10	0.002
Off	–	SK615552-21	10	0.002
On	–	SK615552-22	10	0.002
Open	–	SK615552-23	10	0.002
Raise	–	SK615552-25	10	0.002
Reset	–	SK615552-27	10	0.002
Reverse	–	SK615552-28	10	0.002
Run	–	SK615552-29	10	0.002
Slow	–	SK615552-30	10	0.002
Start	–	SK615550-44	10	0.002
Stop	–	SK615552-31	10	0.002
Up	–	SK615552-32	10	0.002

3-position engraved for selector switches

Legend plate height 39 mm

Pos.31	Pos.32	Pos.33		
I	O	II	–	SK615550-81 10 0.002
←	O	→	–	SK615562-82 10 0.002
Hand	O	Auto	–	SK615550-80 10 0.002

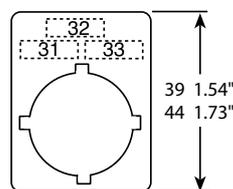

3-position engraved
Dimensions (mm, inches)

Legend plates and text caps

Text caps for illuminated pushbuttons and pilot lights



Description

To be mounted under the lens of illuminated pushbutton or pilot light to add symbol or text. Choose only white text caps with illuminated products due to high opacity of the colored text caps. Choose colored text caps in combination with clear lens.

Text/symbol	Color	Type	Order code	Pkg qty	Weight (1pce) kg
For flush pushbuttons					
Without text	○ White	KTC1-9000	1SFA616901R9000	10	0.001
START	○ White	KTC6-1042	1SFA616906R1042	10	0.001
R	○ White	KTC1-9009	1SFA616901R9009	10	0.001
On	○ White	KTC1-1020	1SFA616901R1020	10	0.001
ON	○ White	KTC1-1039	1SFA616901R1039	10	0.001
	● Green	KTC6-1039	1SFA616906R1039	10	0.001
	● Black	KTC8-1039	1SFA616908R1039	10	0.001
Off	○ White	KTC1-1019	1SFA616901R1019	10	0.001
Stop	○ White	KTC1-1031	1SFA616901R1031	10	0.001
STOP	● Red	KTC4-1047	1SFA616904R1047	10	0.001
Reset	○ White	KTC1-1025	1SFA616901R1025	10	0.001
O	○ White	KTC1-9004	1SFA616901R9004	10	0.001
	● Red	KTC4-9004	1SFA616904R9004	10	0.001
	● Black	KTC8-9004	1SFA616908R9004	10	0.001
I	○ White	KTC1-9002	1SFA616901R9002	10	0.001
	● Green	KTC6-9002	1SFA616906R9002	10	0.001
	● Black	KTC8-9002	1SFA616908R9002	10	0.001
II	○ White	KTC1-9003	1SFA616901R9003	10	0.001
	● Black	KTC8-9003	1SFA616908R9003	10	0.001
III	○ White	KTC1-9028	1SFA616901R9028	10	0.001
+	● Black	KTC8-9011	1SFA616908R9011	10	0.001
-	● Black	KTC8-9012	1SFA616908R9012	10	0.001
↑	○ White	KTC1-9005	1SFA616901R9005	10	0.001
	● Black	KTC8-9005	1SFA616908R9005	10	0.001
↔	● Black	KTC8-9015	1SFA616908R9015	10	0.001
↔	○ White	KTC1-9016	1SFA616901R9016	10	0.001
	● Black	KTC8-9016	1SFA616908R9016	10	0.001
→	○ White	KTC1-9006	1SFA616901R9006	10	0.001
	● Black	KTC8-9018	1SFA616908R9018	10	0.001
⊕	○ White	KTC1-9020	1SFA616901R9020	10	0.001
⊖	○ White	KTC1-9026	1SFA616901R9026	10	0.001
	● Black	KTC8-9026	1SFA616908R9026	10	0.001
For extended pushbuttons					
Without text	○ White	KTC2-9000	1SFA616902R9000	10	0.001
On	○ White	KTC2-1020	1SFA616902R1020	10	0.001
Off	● Red	KTC5-1040	1SFA616905R1040	10	0.001
Stop	○ White	KTC2-1031	1SFA616902R1031	10	0.001
STOP	● Red	KTC5-1047	1SFA616905R1047	10	0.001
Reset	○ White	KTC2-1025	1SFA616902R1025	10	0.001
O	● Red	KTC5-9004	1SFA616905R9004	10	0.001
I	○ White	KTC2-9002	1SFA616902R9002	10	0.001
II	○ White	KTC2-9003	1SFA616902R9003	10	0.001
III	○ White	KTC2-9028	1SFA616902R9028	10	0.001
↑	○ White	KTC2-9005	1SFA616902R9005	10	0.001
↔	○ White	KTC2-9015	1SFA616902R9015	10	0.001
↔	○ White	KTC2-9016	1SFA616902R9016	10	0.001
→	○ White	KTC2-9006	1SFA616902R9006	10	0.001
For pilot lights					
Without text	○ White	KTC3-9000	1SFA616903R9000	10	0.001
On	○ White	KTC3-1020	1SFA616903R1020	10	0.001
ON	○ White	KTC3-1039	1SFA616903R1039	10	0.001
Off	○ White	KTC3-1019	1SFA616903R1019	10	0.001
I	○ White	KTC3-9002	1SFA616903R9002	10	0.001

Pilot devices

Signal towers and signal beacons

Ordering details

- 143 Signal towers - Light elements
- 144 Signal towers - Bulbs and audible modules
- 145 Signal towers - Bulbs and audible modules - Accessories
- 146 Signal beacons

147 Technical data

148 Dimensions and drilling plans

Signal towers and signal beacons



Signal towers

- Fast mounting of signal elements using bayonet fixing
- Easy changing of bulbs for each module without tools
- Flexibility of signal element combination
- Up to 5 elements possible/up to 10 elements with bracket for 2-sided mounting
- High protection rating optical and audible signal elements with IP54
- LED elements for long life

Signal beacons

- High protection rating IP65
- Cap consists of high impact polycarbonate (up to 20 J)
- Bulb change via inside of control box

Simple fitting with quick fix system

Each signal tower module is equipped with a bayonet fixing with integral contact system. The modules are fastened together by aligning the corresponding white marks then with a gentle twist they are locked into place (see the figures).

Signal towers and beacons

- Permanent light
- Blinking light
- Flashing light
- Audible
- LED permanent light
- LED blinking light
- LED rotating light

Signal towers and signal beacons

Signal towers - Light elements



KL70-401B

1SFC151507F0001



KL70-401Y

1SFC151508F0001



KA4-102...

1SFC151509F0001

Description

When ordering:

- Select up to 5 light elements
- Select up to 10 elements if bracket for 2-sided mounting is used
- Select up to 2 audible elements if bracket for 2-sided mounting is used (optional)
- Select bulb (optional)
- Select terminal element for preferred mounting type
- Select accessories for preferred mounting type.

Color	Rated voltage	Type	Order code	Pkg qty	Weight (1pce) kg
Light element with integrated LED					
● Red	24 V AC/DC	Permanent light	KL70-305R 1SFA616070R3051	1	0.100
● Green	24 V AC/DC	Permanent light	KL70-305G 1SFA616070R3052	1	0.100
● Yellow	24 V AC/DC	Permanent light	KL70-305Y 1SFA616070R3053	1	0.100
● Blue	24 V AC/DC	Permanent light	KL70-305L 1SFA616070R3054	1	0.100
○ Clear	24 V AC/DC	Permanent light	KL70-305C 1SFA616070R3058	1	0.100
● Red	24 V AC/DC	Blinking light	KL70-306R 1SFA616070R3061	1	0.100
● Green	24 V AC/DC	Blinking light	KL70-306G 1SFA616070R3062	1	0.100
● Yellow	24 V AC/DC	Blinking light	KL70-306Y 1SFA616070R3063	1	0.100
● Blue	24 V AC/DC	Blinking light	KL70-306L 1SFA616070R3064	1	0.100
○ Clear	24 V AC/DC	Blinking light	KL70-306C 1SFA616070R3068	1	0.100
● Red	24 V AC/DC	Rotating light	KL70-307R 1SFA616070R3071	1	0.100
● Green	24 V AC/DC	Rotating light	KL70-307G 1SFA616070R3072	1	0.100
● Yellow	24 V AC/DC	Rotating light	KL70-307Y 1SFA616070R3073	1	0.100
● Blue	24 V AC/DC	Rotating light	KL70-307L 1SFA616070R3074	1	0.100
○ Clear	24 V AC/DC	Rotating light	KL70-307C 1SFA616070R3078	1	0.100
● Red	115 V AC	Blinking light	KL70-342R 1SFA616070R3421	1	0.100
● Green	115 V AC	Blinking light	KL70-342G 1SFA616070R3422	1	0.100
● Yellow	115 V AC	Blinking light	KL70-342Y 1SFA616070R3423	1	0.100
● Blue	115 V AC	Blinking light	KL70-342L 1SFA616070R3424	1	0.100
○ Clear	115 V AC	Blinking light	KL70-342C 1SFA616070R3428	1	0.100
● Red	230 V AC	Blinking light	KL70-352R 1SFA616070R3521	1	0.100
● Green	230 V AC	Blinking light	KL70-352G 1SFA616070R3522	1	0.100
● Yellow	230 V AC	Blinking light	KL70-352Y 1SFA616070R3523	1	0.100
● Blue	230 V AC	Blinking light	KL70-352L 1SFA616070R3524	1	0.100
○ Clear	230 V AC	Blinking light	KL70-352C 1SFA616070R3528	1	0.100
Light element for bulb Ba 15d, bulb not included					
● Red	12 ... 230 V AC/DC	Permanent light	KL70-401R 1SFA616070R4011	1	0.090
● Green	12 ... 230 V AC/DC	Permanent light	KL70-401G 1SFA616070R4012	1	0.090
● Yellow	12 ... 230 V AC/DC	Permanent light	KL70-401Y 1SFA616070R4013	1	0.090
● Blue	12 ... 230 V AC/DC	Permanent light	KL70-401L 1SFA616070R4014	1	0.090
○ Clear	12 ... 230 V AC/DC	Permanent light	KL70-401C 1SFA616070R4018	1	0.090

Signal towers and signal beacons

Signal towers - Bulbs and audible modules



KL70-401B

1SFC151507P001



KL70-401Y

1SFC151508F001



KA4-102...

1SFC151509F001

Description

When ordering:

- Select up to 5 light elements
- Select up to 10 elements if bracket for 2-sided mounting is used
- Select up to 2 audible element (optional)
- Select bulb (optional)
- Select terminal element for preferred mounting type
- Select accessories for preferred mounting type.

Description	Rated voltage	Type	Order code	Pkg qty	Weight (1pce) kg
Bulbs for light element					
Bulb Ba 15d, 42 mm max 7 W					
For permanent or blinking light element	24 V AC/DC, 5 W	KA4-1028	1SFA616923R1028	10	0.009
For permanent or blinking light element	115 V AC/DC, 5 W	KA4-1118	1SFA616923R1118	10	0.009
For permanent or blinking light element	230 V AC/DC, 5 W	KA4-1148	1SFA616923R1148	10	0.009
LED bulbs Ba 15d, 40mA					
● Red	24 V AC/DC	KA4-1021	1SFA616924R1021	1	0.009
● Green	24 V AC/DC	KA4-1022	1SFA616924R1022	1	0.009
● Yellow	24 V AC/DC	KA4-1023	1SFA616924R1023	1	0.009
● Blue	24 V AC/DC	KA4-1024	1SFA616924R1024	1	0.009
○ Clear	24 V AC/DC	KA4-1025	1SFA616924R1025	1	0.009

Audible modules

Buzzer element

Adjustable tone, 85 dB

Continuous or pulsating tone	230 V AC	KB70-1201	1SFA616071R1201	1	0.120
Continuous or pulsating tone	24 V AC/DC	KB70-3001	1SFA616071R3001	1	0.110
Continuous or pulsating tone	115 V AC	KB70-3101	1SFA616071R3101	1	0.110

Siren element

Multi function 8 diff. Tones adjustable volume adjustable 100 dB	115 V AC	KS70-1104	1SFA616073R1104	1	0.130
Multi function 8 diff. Tones adjustable volume adjustable 100 dB	230 V AC	KS70-1204	1SFA616073R1204	1	0.120
Multi function 7 diff. Tones adjustable volume adjustable 100 dB	24 V DC	KS70-2004	1SFA616073R2004	1	0.120
Multi function 8 diff. Tones adjustable volume adjustable 100 dB	24 V AC/DC	KS70-3004	1SFA616073R3004	1	0.120
Continuous tone alternating 108 dB	24 V DC	KS70-2002	1SFA616073R2002	1	0.150

Signal towers and signal beacons

Accessories



KT70-1001

1SFC151510F0001



KA70-1001

1SFC151511F0001



KA70-1034

1SFC151512F0001

Description	Type	Order code	Pkg qty	Weight (1pce) kg
Terminal elements				
For tube mounting, including cap	KT70-1001	1SFA616075R1001	1	0.150
For bracket or base, including cap	KT70-1002	1SFA616075R1002	1	0.150
Special parts				
Contact box				
Cable exit at side	KA70-1001	1SFA616077R1001	1	0.070
Magnetic base	KA70-1002	1SFA616077R1002	1	0.070
Base with tube				
D=25 mm L=110 mm	KA70-1011	1SFA616077R1011	1	0.060
Base for tube				
D=25 mm, plastic	KA70-1012	1SFA616077R1012	1	0.030
D=25 mm, metal	KA70-1013	1SFA616077R1013	1	0.320
Tube, anodized aluminum				
D=25 mm L=250 mm	KA70-1021	1SFA616077R1021	1	0.080
D=25 mm L=400 mm	KA70-1022	1SFA616077R1022	1	0.120
D=25 mm L=800 mm	KA70-1023	1SFA616077R1023	1	0.240
Bracket				
1-sided mounting, max. 5 elements	KA70-1031	1SFA616077R1031	1	0.070
2-sided mounting, max. 10 elements	KA70-1032	1SFA616077R1032	1	0.070
For tube mounting	KA70-1033	1SFA616077R1033	1	0.070
For surface mounting	KA70-1034	1SFA616077R1034	1	0.070

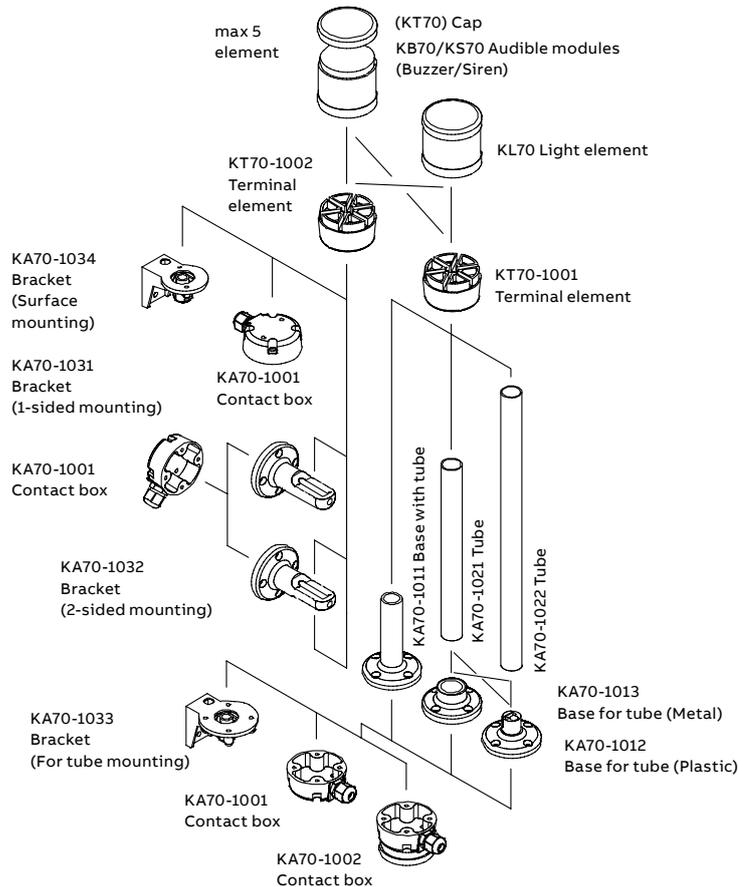

Signal towers and signal beacons

Signal beacons



KSB-401G

1SFC1513F0001



KASB-100

1SFC1514F0001

Description

For panel mounting with hole diameter 37 mm, with optional anti-twist device.

Color	Rated voltage	Type	Order code	Pkg qty	Weight (1pce) kg
Integrated LED					
● Red	24 V AC/DC	Permanent light	KSB-305R 1SFA616080R3051	1	0.140
● Green	24 V AC/DC	Permanent light	KSB-305G 1SFA616080R3052	1	0.140
● Yellow	24 V AC/DC	Permanent light	KSB-305Y 1SFA616080R3053	1	0.140
● Red	24 V AC/DC	Blinking light	KSB-306R 1SFA616080R3061	1	0.140
● Green	24 V AC/DC	Blinking light	KSB-306G 1SFA616080R3062	1	0.140
● Yellow	24 V AC/DC	Blinking light	KSB-306Y 1SFA616080R3063	1	0.140
● Red	24 V AC/DC	Rotating light	KSB-307R 1SFA616080R3071	1	0.140
● Green	24 V AC/DC	Rotating light	KSB-307G 1SFA616080R3072	1	0.140
● Yellow	24 V AC/DC	Rotating light	KSB-307Y 1SFA616080R3073	1	0.140
● Red	115 V AC	Permanent light	KSB-115R 1SFA616080R1151	1	0.140
● Green	115 V AC	Permanent light	KSB-115G 1SFA616080R1152	1	0.140
● Yellow	115 V AC	Permanent light	KSB-115Y 1SFA616080R1153	1	0.140

Integrated xenon tube

● Red	24 V DC	Flashing light	KSB-203R 1SFA616080R2031	1	0.140
● Green	24 V DC	Flashing light	KSB-203G 1SFA616080R2032	1	0.140
● Yellow	24 V DC	Flashing light	KSB-203Y 1SFA616080R2033	1	0.140
● Blue	24 V DC	Flashing light	KSB-203L 1SFA616080R2034	1	0.140
○ Clear	24 V DC	Flashing light	KSB-203C 1SFA616080R2038	1	0.140
● Red	115 V AC	Flashing light	KSB-113R 1SFA616080R1131	1	0.140
● Green	115 V AC	Flashing light	KSB-113G 1SFA616080R1132	1	0.140
● Yellow	115 V AC	Flashing light	KSB-113Y 1SFA616080R1133	1	0.140
● Blue	115 V AC	Flashing light	KSB-113L 1SFA616080R1134	1	0.140
○ Clear	115 V AC	Flashing light	KSB-113C 1SFA616080R1138	1	0.140
● Red	230 V AC	Flashing light	KSB-123R 1SFA616080R1231	1	0.140
● Green	230 V AC	Flashing light	KSB-123G 1SFA616080R1232	1	0.140
● Yellow	230 V AC	Flashing light	KSB-123Y 1SFA616080R1233	1	0.140
● Blue	230 V AC	Flashing light	KSB-123L 1SFA616080R1234	1	0.140
○ Clear	230 V AC	Flashing light	KSB-123C 1SFA616080R1238	1	0.140

For bulb Ba 15d, bulb not included

● Red	12 ... 240 V AC/DC	Permanent light	KSB-401R 1SFA616080R4011	1	0.130
● Green	12 ... 240 V AC/DC	Permanent light	KSB-401G 1SFA616080R4012	1	0.130
● Yellow	12 ... 240 V AC/DC	Permanent light	KSB-401Y 1SFA616080R4013	1	0.130
● Blue	12 ... 240 V AC/DC	Permanent light	KSB-401L 1SFA616080R4014	1	0.130
○ Clear	12 ... 240 V AC/DC	Permanent light	KSB-401C 1SFA616080R4018	1	0.130

Bulbs for light element

Bulb Ba 15d, 42 mm

max 10 W for permanent light

	12 V AC/DC, 7 W	KA3-1018	1SFA616922R1018	10	0.011
	24 V AC/DC, 7 W	KA3-1028	1SFA616922R1028	10	0.011
	115 V AC/DC, 7 W	KA3-1118	1SFA616922R1118	10	0.011
	220 ... 260 V AC/DC, 7 ... 10 W	KA3-1148	1SFA616922R1148	10	0.011

Special parts

Anti-twist device	KASB-1000	1SFA616087R1000	1	0.005
-------------------	-----------	-----------------	---	-------

Signal towers and signal beacons

Technical data

Signal towers K70			
Technical specifications			
Housing and accessories	Polyamide, high impact, black		
Dome	Polycarbonate, transparent		
Fixing	Base mounting, tube Ø 25mm, bracket mounting		
Socket	B 15 d, for bulb max. 7W		
Connection	Screw connection up to 2.5 mm ²		
Number of modules possible 1-sided bracket	max. 5		
Number of modules possible 2-sided bracket	max. 10		
Degrees of protection			
Light elements	IP 54	UL type 5	
Audible elements	IP 54	UL type 5	
Electrical data			
Permanent light element	12 ... 240 V		
Bulb socket B 15 d, max 7 W	Bulb not included		
Flashing light element	24 V DC	115 V AC	230 V AC
Flash frequency	1 Hz	1 Hz	1 Hz
Flash energy	2 Ws	2 Ws	2 Ws
Life duration	4 million flashes		
Current consumption	125 mA	22 mA	15 mA
Reduced for AS-Interface	80 mA	80 mA	80 mA
Starting current	< 0.5 A at 24 V		
LED permanent light element	24 V AC/DC	115 V AC	230 V AC
Life duration	100 000 hours		
Current consumption	45 mA	25mA	25mA
Starting current	< 0.5 A at 24 V		
LED blinking light element	24 V AC/DC	115 V AC	230 V AC
Life duration	100 000 hours		
Current consumption	25 mA	25mA	25mA
Starting current	< 0.5 A at 24 V		
Blink frequency	~ 1 Hz	~ 1 Hz	~ 1 Hz
LED rotation light element	24 V AC/DC		
Life duration	50 000 hours		
Current consumption	40 mA		
Starting current	< 0.5 A at 24 V		
Rotation frequency	~ 120 r.p.m.		
Temperature			
Ambient temperature during operations	-20 to +50 °C		

Signal beacons KSB			
Technical specifications			
Housing and accessories	PC/ABS-blend, high impact, black		
Dome	Polycarbonate, transparent		
Fixing	Installation mounting for Ø 37mm, (PG 29)		
Bulb socket	B 15 d, for bulb max. 10W		
Bulb change	Via rear access with bayonet mechanism (Bulb not included)		
Connection	Screw connection max 2.5 mm ²		
Degrees of protection	IP 65, UL type 5		
Electrical data			
Permanent light element			
Operating voltage	max. 250 V		
Life duration	100 000 hours		
Bulb socket B 15 d, max 10 W	Bulb not included		
LED version: Permanent light	24 V AC/DC		
Life duration	100 000 hours		
Current consumption	45 mA		
Blinking light element	24 V, AC/DC		
Life duration	100 000 hours		
Current consumption	25 mA		
Rotation light element	24 V AC/DC		
Life duration	100 000 hours		
Current consumption	70 mA		
Starting current	< 0.5 A		
Flashing light element			
Operating voltage	24 V AC/DC	115 V AC	230 V AC
Flash frequency	1 Hz	1 Hz	1 Hz
Flash energy	2 Ws	2 Ws	2 Ws
Life duration	4 million flashes		
Current consumption	125 mA	20mA	35 mA
Starting current	< 0.5 A	< 0.5 A	< 0.5 A
Temperature			
Ambient temperature during operations	-20 to +50 °C		

General technical data

Color selection

Color selection according to IEC 60073

IEC 60073 specifies coding principles for indicators and actuators and gives recommendation regarding the use of colors. An excerpt from the standard is given below. For detailed information, see the standard.

Meaning of colors – General principles				
Color		Safety of persons or environment	Condition of process	State of equipment
●	Red	Danger	Emergency	Faulty
●	Yellow	Warning/caution	Abnormal	Abnormal
●	Green	Safe	Normal	Normal
●	Blue	Mandatory significance		
○ ● ●	White, grey, black	No specific meaning assigned		

Non-illuminated actuators

Emergency Actuators
EMERGENCY STOP / OFF actuators shall be identified by the color RED.

STOP / OFF actuators

WHITE, GREY and BLACK are the preferred colors for STOP / OFF actuators, with the main preference being for BLACK. RED is also permitted. GREEN shall not be used.

START / ON actuators

WHITE, GREY and BLACK are the preferred colors for START / ON actuators, which cause the closing of switching devices and the equipment to start, with the main preference being for WHITE. GREEN is also permitted. RED shall not be used.

Use of WHITE and BLACK for specific meanings

Where the colors WHITE and BLACK are used to distinguish between START / ON and STOP / OFF actuators, then the color WHITE shall be used for START / ON actuators and the color BLACK shall be used for STOP / OFF actuators.

The same actuators serving for START / STOP or ON / OFF

WHITE, GREY and BLACK are the preferred colors for actuators which, when actuated several times, act alternately as a START / ON and STOP / OFF actuator.

The colors YELLOW and GREEN shall not be used. The color RED shall be used only in cases where the same actuator, other than a pushbutton, is used for both EMERGENCY STOP / OFF and normal operation.

WHITE, GREY and BLACK are preferred colors for actuators which cause a movement while they are actuated and stop the movement when they are released (such as inching or jogging actuators). GREEN is also permitted. RED shall not be used.

RESET actuators

RESET Actuators (used, for example, with protective relays) shall be BLUE, WHITE, GREY or BLACK, except RESET actuators which also act as STOP / OFF actuators. The color of such STOP / OFF actuators shall be in accordance with STOP / OFF actuators above.

General technical data

Degrees of protection

In an installation, the degree of protection required for electrical equipment depends on the environmental characteristics.

The degree of protection, ensured by the enclosure of equipment or by the cubicle containing the equipment is expressed by the IP code which gives the level of protection against access to hazardous parts, the ingress of foreign bodies and/or the ingress of water, in compliance with IEC 60529, IEC 60947-1. Besides the IP symbol, the complete code has two figures followed (optionally) by two additional letters. A short description of the elements used in IP coding is given below.

First figure	Specifications for installation protection	Protection of persons
	Against ingress of foreign bodies	Against access to hazardous parts with:
IP 0	No protection	No protection
1	Diameter > 50 mm	Back of hand
2	Diameter > 12.5 mm	Finger
3	Diameter > 2.5 mm	Tool
4	Diameter > 1 mm	Wire
5	Limited protection against dust	Wire
6	Total protection against dust	Wire
Second figure	Against entrance of water having a harmful effect	
0	No protection	
1	Vertical dripping	
2	Dripping at a vertical angle of < 15°	
3	Rain at a vertical angle of < 60°	
4	Splashing	
5	Low pressure water jet	
6	Powerful water jets	
7	Temporary immersion	
8	Permanent immersion	
9K*	High pressure, high temperature washdown	



Note: the type of enclosure or cubicle in which the equipment must be installed prevails with respect to the degree of protection.

(*) According to DIN 400 50-9.

Water tests

IP67

The product is submerged

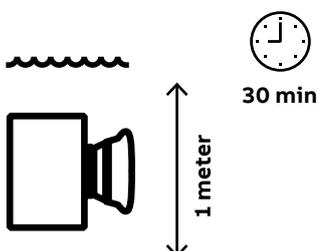

IP69K

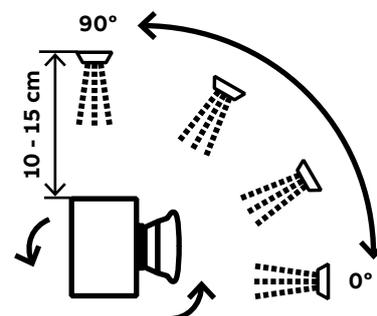

Index

Order code classification

Order code	Type	Page	Order code	Type	Page	Order code	Type	Page
1SFA170190R8000	080CPN	3/80	1SFA184201R9001	P9MSMZ0R	3/64	1SFA184613R9103	P9MSLZ1G	3/65
1SFA170191R8000	080CPR	3/80	1SFA184240R9006	P9MSMZ1N	3/64	1SFA184616R9104	P9MSLZ1L	3/65
1SFA170192R8000	080CPV	3/80	1SFA184241R9001	P9MSMZ1R	3/64	1SFA184617R9105	P9MSLZ1B	3/65
1SFA170198R8000	080CPT	3/80	1SFA184280R9006	P9MSMZ5N	3/64	1SFA184621R9101	P9MSLZ5R	3/65
1SFA170801R1001	080SP1	3/81	1SFA184320R9006	P9MSMZ3N	3/64	1SFA184622R9102	P9MSLZ5V	3/65
1SFA170802R1002	080SP2	3/81	1SFA184321R9001	P9MSMZ3R	3/64	1SFA184626R9104	P9MSLZ5L	3/65
1SFA170803R1003	080SP3	3/81	1SFA184340R9006	P9MSMX5N	3/66	1SFA184628R9108	P9MSLZ5I	3/65
1SFA170804R1004	080SP4	3/81	1SFA184350R9006	P9MSMY0N	3/67	1SFA184631R9101	P9MSLZ3R	3/65
1SFA170806R1006	080SP6	3/81	1SFA184351R9001	P9MSMY0R	3/67	1SFA184632R9102	P9MSLZ3V	3/65
1SFA170807R1008	080SP8	3/81	1SFA184360R9006	P9MSMW0N	3/67	1SFA184633R9103	P9MSLZ3G	3/65
1SFA170808R1012	080SP12	3/81	1SFA184370R9006	P9MSVD0N	3/62	1SFA184635R9109	P9MSLZ3A	3/65
1SFA170809R1018	080SP18	3/81	1SFA184371R9006	P9MSV10N	3/62	1SFA184636R9104	P9MSLZ3L	3/65
1SFA170810R1024	080SP24	3/81	1SFA184373R9006	P9MSVD5N	3/62	1SFA184637R9105	P9MSLZ3B	3/65
1SFA170831R1001	080SP1M	3/81	1SFA184374R9006	P9MSV15N	3/62	1SFA184638R9108	P9MSLZ3I	3/65
1SFA170832R1002	080SP2M	3/81	1SFA184379R9006	P9MSV20N	3/64	1SFA184641R9101	P9MSAD0R	3/63
1SFA170834R1004	080SP4M	3/81	1SFA184383R9006	P9MSV21N	3/64	1SFA184642R9102	P9MSAD0V	3/63
1SFA170835R2000	080SP1SFC	3/82	1SFA184387R9006	P9MSV25N	3/64	1SFA184646R9104	P9MSAD0L	3/63
1SFA170836R3001	080SP1SFE	3/81	1SFA184391R9006	P9MSV23N	3/64	1SFA184647R9105	P9MSAD0B	3/63
1SFA170837R4000	080SP1SF	3/82	1SFA184392R9006	P9MSVX0N	3/66	1SFA184652R9102	P9MSAZ0V	3/65
1SFA170838R2000	080SP1MSFC	3/82	1SFA184393R9006	P9MSVX5N	3/66	1SFA184657R9105	P9MSAZ0B	3/65
1SFA170839R3001	080SP1MSFE	3/81	1SFA184397R9006	P9MSMX0N	3/66	1SFA184682R9102	P9MSAZ3V	3/65
1SFA170840R4000	080SP1MSF	3/82	1SFA184400R9006	P9MSCD0A95	3/68	1SFA184685R9109	P9MSAZ3A	3/65
1SFA170841R2000	080SP2SFC	3/82	1SFA184401R9006	P9MSCD0E95	3/68	1SFA184687R9105	P9MSAZ3B	3/65
1SFA170842R3002	080SP2SFE	3/81	1SFA184402R9006	P9MSCD0K95	3/68	1SFA184691R9006	P9MPS22G	3/75
1SFA170843R4000	080SP2SF	3/82	1SFA184403R9006	P9MSCI0C95	3/68	1SFA184693R9006	P9MPS34G	3/75
1SFA170844R2000	080SP2MSFC	3/82	1SFA184404R9006	P9MSCI0E95	3/68	1SFA184695R9006	P9MCD	3/74
1SFA170846R4000	080SP2MSF	3/82	1SFA184405R9006	P9MSCI0N95	3/68	1SFA184696R9006	P9MCCB	3/74
1SFA170847R2000	080SP3SFC	3/82	1SFA184409R9006	P9MSCD5A95	3/68	1SFA184697R9006	P9MCC	3/74
1SFA170848R3003	080SP3SFE	3/81	1SFA184410R9006	P9MSCI5C95	3/68	1SFA184700R9006	P9MMN2F	3/72
1SFA170849R4000	080SP3SF	3/82	1SFA184433R9006	P9MSC20A95	3/69	1SFA184701R9006	P9MMN2T	3/72
1SFA170850R3004	080SP4SFE	3/81	1SFA184434R9006	P9MSC20C95	3/69	1SFA184702R9006	P9MMN2A	3/72
1SFA170852R3006	080SP6SFE	3/81	1SFA184436R9006	P9MSC20H95	3/69	1SFA184703R9006	P9MMN2B	3/72
1SFA170853R2000	080SP8SFC	3/82	1SFA184438R9006	P9MSC20N95	3/69	1SFA184709R9006	P9MMB2FG	3/72
1SFA170854R3008	080SP8SFE	3/81	1SFA184439R9006	P9MSC20T95	3/69	1SFA184710R9006	P9MMB2F	3/72
1SFA170855R4000	080SP8SF	3/82	1SFA184449R9006	P9MSC21C95	3/69	1SFA184711R9006	P9MMB2T	3/72
1SFA170856R2000	080SP12SFC	3/82	1SFA184451R9006	P9MSC21N95	3/69	1SFA184712R9006	P9MMB2A	3/72
1SFA170857R3012	080SP12SFE	3/81	1SFA184461R9006	P9MSC25A95	3/70	1SFA184716R9006	P9MMN4TG	3/72
1SFA170858R4000	080SP12SF	3/82	1SFA184462R9006	P9MSC25C95	3/70	1SFA184720R9006	P9MMN4F	3/72
1SFA170859R2000	080SP18SFC	3/82	1SFA184463R9006	P9MSC25H95	3/70	1SFA184721R9006	P9MMN4T	3/72
1SFA170861R4000	080SP18SF	3/82	1SFA184467R9006	P9MSC23C95	3/70	1SFA184740R9006	P9MMB4F	3/72
1SFA184000R9006	P9MPNNG	3/56	1SFA184468R9006	P9MSCX0A95	3/71	1SFA184741R9006	P9MMB4T	3/72
1SFA184001R9001	P9MPNNG	3/56	1SFA184482R9006	P9MSCX0Z95	3/71	1SFA184744R9006	P9MMB4TG	3/72
1SFA184002R9002	P9MPNNG	3/56	1SFA184491R9101	P9MPLRGD	3/58	1SFA184791R9001	P9MLRD	3/61
1SFA184003R9003	P9MPNNG	3/56	1SFA184492R9102	P9MPLVGD	3/58	1SFA184792R9002	P9MLVD	3/61
1SFA184006R9004	P9MPNLG	3/56	1SFA184493R9103	P9MPLGGD	3/58	1SFA184793R9003	P9MLGD	3/61
1SFA184007R9005	P9MPNNG	3/56	1SFA184495R9109	P9MPLAGD	3/58	1SFA184795R9009	P9MLAD	3/61
1SFA184008R9007	P9MPNHG	3/56	1SFA184496R9104	P9MPLLGD	3/58	1SFA184796R9004	P9MLLD	3/61
1SFA184010R9006	P9MPNNS	3/56	1SFA184497R9105	P9MPLBGD	3/58	1SFA184797R9105	P9MLBD	3/61
1SFA184011R9001	P9MPNRS	3/56	1SFA184498R9108	P9MPLIGD	3/58	1SFA184798R9008	P9MLID	3/61
1SFA184012R9002	P9MPNVS	3/56	1SFA184501R9101	P9MPLRSD	3/58	1SFA184822R9003	P9MSVDO	3/62
1SFA184016R9004	P9MPNLS	3/56	1SFA184502R9102	P9MPLVSD	3/58	1SFA187000R8011	P9B11VN	3/76
1SFA184017R9005	P9MPNBS	3/56	1SFA184503R9103	P9MPLGSD	3/58	1SFA187001R8010	P9B01VN	3/76
1SFA184030R9006	P9MEM3NN	3/59	1SFA184505R9109	P9MPLASD	3/58	1SFA187002R8001	P9B10VN	3/76
1SFA184031R9001	P9MEM3RN	3/59	1SFA184506R9104	P9MPLLSD	3/58	1SFA187003R8110	P9B01VR	3/76
1SFA184032R9002	P9MEM3VN	3/59	1SFA184507R9105	P9MPLBSD	3/58	1SFA187004R8201	P9B10VA	3/76
1SFA184033R9003	P9MEM3GN	3/59	1SFA184521R9101	P9MPLRGV	3/58	1SFA187008R8020	P9B02VN	3/76
1SFA184040R9006	P9MEM4NN	3/59	1SFA184522R9102	P9MPLVGV	3/58	1SFA187009R8002	P9B20VN	3/76
1SFA184041R9001	P9MEM4RN	3/59	1SFA184523R9103	P9MPLGGV	3/58	1SFA187012R8310	P9B01FN	3/76
1SFA184042R9002	P9MEM4VN	3/59	1SFA184526R9104	P9MPLLGV	3/58	1SFA187013R8301	P9B10FN	3/76
1SFA184043R9003	P9MEM4GN	3/59	1SFA184527R9105	P9MPLBGV	3/58	1SFA187020R1080	P9PDNV0	3/77
1SFA184050R9006	P9MEM6NN	3/59	1SFA184551R9101	P9MEM4RL	3/60	1SFA187027R8000	P9PDTV0	3/77
1SFA184051R9001	P9MEM6RN	3/59	1SFA184552R9102	P9MEM4VL	3/60	1SFA187055R1300	P9PDNF0	3/77
1SFA184052R9002	P9MEM6VN	3/59	1SFA184553R9103	P9MEM4GL	3/60	1SFA187101R90501	P9MPNNG029	3/57
1SFA184053R9003	P9MEM6GN	3/59	1SFA184556R9104	P9MEM4LL	3/60	1SFA187111R90506	P9MPNNG028	3/57
1SFA184057R9003	P9MPNNGS	3/56	1SFA184561R9101	P9MET4RL1	3/60	1SFA187112R90502	P9MPNVG028	3/57
1SFA184060R9006	P9MET4NN1	3/59	1SFA184562R9102	P9MET4VL1	3/60	1SFA187117R90506	P9MPNNG006	3/57
1SFA184061R9001	P9MET4RN1	3/59	1SFA184563R9103	P9MET4GL1	3/60	1SFA187118R90502	P9MPNVG006	3/57
1SFA184062R9002	P9MET4VN1	3/59	1SFA184566R9104	P9MET4LL1	3/60	1SFA187139R90506	P9MPNNG002	3/57
1SFA184063R9003	P9MET4GN1	3/59	1SFA184591R9101	P9MSLD0R	3/63	1SFA187143R90504	P9MPNLG037	3/57
1SFA184070R9001	P9MER3RN	3/59	1SFA184592R9102	P9MSLD0V	3/63	1SFA187145R90506	P9MPNNG030	3/57
1SFA184071R9001	P9MER4RN	3/59	1SFA184593R9103	P9MSLD0G	3/63	1SFA187146R90502	P9MPNVG030	3/57
1SFA184073R9001	P9MEC4RN95	3/59	1SFA184595R9109	P9MSLD0A	3/63	1SFA187147R90501	P9MPNNG021	3/57
1SFA184110R9006	P9MSMD0N	3/62	1SFA184596R9104	P9MSLD0L	3/63	1SFA187149R90502	P9MPNVG202	3/57
1SFA184111R9001	P9MSMD0R	3/62	1SFA184597R9105	P9MSLD0B	3/63	1SFA187150R90506	P9MPNNG029	3/57
1SFA184120R9006	P9MSMI0N	3/62	1SFA184598R9108	P9MSLD0I	3/63	1SFA187151R90505	P9MPNBG028	3/57
1SFA184123R9003	P9MSMI0G	3/62	1SFA184601R9101	P9MSLZ0R	3/65	1SFA187152R90505	P9MPNBG006	3/57
1SFA184140R9006	P9MSMD5N	3/62	1SFA184602R9102	P9MSLZ0V	3/65	1SFA187160R1005	BA956LEDB	3/78
1SFA184141R9001	P9MSMD5R	3/62	1SFA184603R9103	P9MSLZ0G	3/65	1SFA187161R1003	BA956LEDG	3/78
1SFA184143R9003	P9MSMD5G	3/62	1SFA184605R9109	P9MSLZ0A	3/65	1SFA187162R1004	BA956LEDL	3/78
1SFA184150R9006	P9MSMI5N	3/62	1SFA184606R9104	P9MSLZ0L	3/65	1SFA187163R1001	BA956LEDR	3/78
1SFA184151R9001	P9MSMI5R	3/62	1SFA184607R9105	P9MSLZ0B	3/65	1SFA187164R1002	BA956LEDV	3/78
1SFA184152R9002	P9MSMI5V	3/62	1SFA184611R9101	P9MSLZ1R	3/65	1SFA187165R1015	BA9512LEDB	3/78
1SFA184200R9006	P9MSMZ0N	3/64	1SFA184612R9102	P9MSLZ1V	3/65	1SFA187166R1013	BA9512LEDG	3/78
						1SFA187167R1014	BA9512LEDL	3/78

Index

Order code classification

Order code	Type	Page	Order code	Type	Page	Order code	Type	Page
1SFA187168R1011	BA9S12LEDR	3/78	1SFA197021R1014	P9PLFVDL	3/79	1SFA611101R3103	MP2-31Y	2/17
1SFA187169R1012	BA9S12LEDV	3/78	1SFA197022R1011	P9PLFVDR	3/79	1SFA611101R3104	MP2-31L	2/17
1SFA187170R1025	BA9S24LEDB	3/78	1SFA197023R1012	P9PLFVDV	3/79	1SFA611101R3105	MP2-31W	2/17
1SFA187171R1023	BA9S24LEDG	3/78	1SFA197025R1045	P9PLFVJB	3/79	1SFA611101R3108	MP2-31C	2/17
1SFA187172R1024	BA9S24LEDL	3/78	1SFA197026R1043	P9PLFVJG	3/79	1SFA611102R1001	MP3-10R	2/16
1SFA187173R1021	BA9S24LEDR	3/78	1SFA197028R1041	P9PLFVJR	3/79	1SFA611102R1002	MP3-10G	2/16
1SFA187174R1022	BA9S24LEDV	3/78	1SFA197031R1075	P9PLFVNB	3/79	1SFA611102R1003	MP3-10Y	2/16
1SFA187175R1035	BA9S48LEDB	3/78	1SFA197032R1073	P9PLFVNG	3/79	1SFA611102R1004	MP3-10L	2/16
1SFA187176R1033	BA9S48LEDG	3/78	1SFA197034R1071	P9PLFVNR	3/79	1SFA611102R1005	MP3-10W	2/16
1SFA187177R1034	BA9S48LEDL	3/78	1SFA205236R8020	P9B02VN-AA	3/76	1SFA611102R1006	MP3-10B	2/16
1SFA187178R1031	BA9S48LEDR	3/78	1SFA215831R1000	P9PDNV0-AA	3/77	1SFA611102R1008	MP3-10C	2/16
1SFA187179R1032	BA9S48LEDV	3/78	1SFA215832R8001	P9B10VN-AA	3/76	1SFA611102R1101	MP3-11R	2/18
1SFA187180R1045	BA9S110LEDB	3/78	1SFA215834R1300	P9PDFN0-AA	3/77	1SFA611102R1102	MP3-11G	2/18
1SFA187181R1043	BA9S110LEDG	3/78	1SFA215835R8301	P9B10FN-AA	3/76	1SFA611102R1103	MP3-11Y	2/18
1SFA187182R1044	BA9S110LEDL	3/78	1SFA242712R8011	P9B11VN-AA	3/76	1SFA611102R1104	MP3-11L	2/18
1SFA187183R1041	BA9S110LEDR	3/78	1SFA611100R1001	MP1-10R	2/15	1SFA611102R1105	MP3-11W	2/18
1SFA187184R1042	BA9S110LEDV	3/78	1SFA611100R1002	MP1-10G	2/15	1SFA611102R1108	MP3-11C	2/18
1SFA187185R1055	BA9S230LEDB	3/78	1SFA611100R1003	MP1-10Y	2/15	1SFA611102R2001	MP3-20R	2/16
1SFA187186R1053	BA9S230LEDG	3/78	1SFA611100R1004	MP1-10L	2/15	1SFA611102R2002	MP3-20G	2/16
1SFA187187R1054	BA9S230LEDL	3/78	1SFA611100R1005	MP1-10W	2/15	1SFA611102R2003	MP3-20Y	2/16
1SFA187188R1051	BA9S230LEDR	3/78	1SFA611100R1006	MP1-10B	2/15	1SFA611102R2004	MP3-20L	2/16
1SFA187189R1052	BA9S230LEDV	3/78	1SFA611100R1008	MP1-10C	2/15	1SFA611102R2005	MP3-20W	2/16
1SFA187190R1045	BA9S130LED	3/78	1SFA611100R1101	MP1-11R	2/17	1SFA611102R2006	MP3-20B	2/16
1SFA187191R1045	BA9S60LED	3/78	1SFA611100R1102	MP1-11G	2/17	1SFA611102R2101	MP3-21R	2/18
1SFA187210R9501	P9MPNRS029	3/57	1SFA611100R1103	MP1-11Y	2/17	1SFA611102R2102	MP3-21G	2/18
1SFA187235R9506	P9MPNNS032	3/57	1SFA611100R1104	MP1-11L	2/17	1SFA611102R2103	MP3-21Y	2/18
1SFA187250R9506	P9MPNNS029	3/57	1SFA611100R1105	MP1-11W	2/17	1SFA611102R2104	MP3-21L	2/18
1SFA187490R8000	P9ARCS	3/80	1SFA611100R1108	MP1-11C	2/17	1SFA611102R2105	MP3-21W	2/18
1SFA187495R8000	P9ARSGMN	3/73	1SFA611100R2001	MP1-20R	2/15	1SFA611102R2108	MP3-21C	2/18
1SFA187496R8000	P9ARSGMB	3/73	1SFA611100R2002	MP1-20G	2/15	1SFA611102R3001	MP3-30R	2/16
1SFA187840R8000	P9ACRCL	3/80	1SFA611100R2003	MP1-20Y	2/15	1SFA611102R3002	MP3-30G	2/16
1SFA187841R8000	P9ACFS3	3/76	1SFA611100R2004	MP1-20L	2/15	1SFA611102R3003	MP3-30Y	2/16
1SFA187842R8000	P9ACFS5	3/76	1SFA611100R2005	MP1-20W	2/15	1SFA611102R3004	MP3-30L	2/16
1SFA187843R8000	P9ACDPP	3/56	1SFA611100R2006	MP1-20B	2/15	1SFA611102R3005	MP3-30W	2/16
1SFA187843R8000	P9ACDPP	3/58	1SFA611100R2008	MP1-20C	2/15	1SFA611102R3006	MP3-30B	2/16
1SFA187843R8000	P9ACDPP	3/80	1SFA611100R2101	MP1-21R	2/17	1SFA611102R3008	MP3-30C	2/16
1SFA187845R8000	P9ACWAF	3/80	1SFA611100R2102	MP1-21G	2/17	1SFA611102R3101	MP3-31R	2/18
1SFA188043R8000	P9ARSCMN	3/73	1SFA611100R2103	MP1-21Y	2/17	1SFA611102R3102	MP3-31G	2/18
1SFA188044R8000	P9ARSCMB	3/73	1SFA611100R2104	MP1-21L	2/17	1SFA611102R3103	MP3-31Y	2/18
1SFA188057R9505	P9MPNBG030	3/57	1SFA611100R2105	MP1-21W	2/17	1SFA611102R3104	MP3-31L	2/18
1SFA188801R8000	P9ARAM32	3/80	1SFA611100R2108	MP1-21C	2/17	1SFA611102R3105	MP3-31W	2/18
1SFA188804R8000	P9ACA6	3/80	1SFA611100R3001	MP1-30R	2/15	1SFA611102R3108	MP3-31C	2/18
1SFA188886R9506	P9MPNNG085	3/57	1SFA611100R3002	MP1-30G	2/15	1SFA611103R1001	MP4-10R	2/16
1SFA188900R9504	P9MPNLG007	3/57	1SFA611100R3003	MP1-30Y	2/15	1SFA611103R1002	MP4-10G	2/16
1SFA188908R9506	P9MPNNG201	3/57	1SFA611100R3004	MP1-30L	2/15	1SFA611103R1003	MP4-10Y	2/16
1SFA192000R9001	P9MEC4RN01	3/59	1SFA611100R3005	MP1-30W	2/15	1SFA611103R1004	MP4-10L	2/16
1SFA192012R9001	P9MEC4RN37	3/59	1SFA611100R3006	MP1-30B	2/15	1SFA611103R1005	MP4-10W	2/16
1SFA192105R9006	P9MSCD0A01	3/68	1SFA611100R3008	MP1-30C	2/15	1SFA611103R1006	MP4-10B	2/16
1SFA192117R9006	P9MSCD0A37	3/68	1SFA611100R3101	MP1-31R	2/17	1SFA611103R1008	MP4-10C	2/16
1SFA192120R9006	P9MSCD0E01	3/68	1SFA611100R3102	MP1-31G	2/17	1SFA611103R1101	MP4-11R	2/18
1SFA192135R9006	P9MSCD0K01	3/68	1SFA611100R3103	MP1-31Y	2/17	1SFA611103R1102	MP4-11G	2/18
1SFA192147R9006	P9MSCD0K37	3/68	1SFA611100R3104	MP1-31L	2/17	1SFA611103R1103	MP4-11Y	2/18
1SFA192150R9006	P9MSCIO0C1	3/68	1SFA611100R3105	MP1-31W	2/17	1SFA611103R1104	MP4-11L	2/18
1SFA192162R9006	P9MSCIOC37	3/68	1SFA611100R3108	MP1-31C	2/17	1SFA611103R1105	MP4-11W	2/18
1SFA192165R9006	P9MSCIOE01	3/68	1SFA611101R1001	MP2-10R	2/15	1SFA611103R1108	MP4-11C	2/18
1SFA192240R9006	P9MSCD5A01	3/68	1SFA611101R1002	MP2-10G	2/15	1SFA611103R2001	MP4-20R	2/16
1SFA192250R9006	P9MSCD5A33	3/68	1SFA611101R1003	MP2-10Y	2/15	1SFA611103R2002	MP4-20G	2/16
1SFA192252R9006	P9MSCD5A37	3/68	1SFA611101R1004	MP2-10L	2/15	1SFA611103R2003	MP4-20Y	2/16
1SFA192255R9006	P9MSCI5C01	3/68	1SFA611101R1005	MP2-10W	2/15	1SFA611103R2004	MP4-20L	2/16
1SFA192267R9006	P9MSCI5C37	3/68	1SFA611101R1006	MP2-10B	2/15	1SFA611103R2101	MP4-21R	2/18
1SFA192690R9006	P9MSCZ0T01	3/69	1SFA611101R1008	MP2-10C	2/15	1SFA611103R2102	MP4-21G	2/18
1SFA192702R9006	P9MSCZ0T37	3/69	1SFA611101R1101	MP2-11R	2/17	1SFA611103R2103	MP4-21Y	2/18
1SFA193020R9006	P9MSCZ5A01	3/70	1SFA611101R1102	MP2-11G	2/17	1SFA611103R2104	MP4-21L	2/18
1SFA193050R9006	P9MSCZ5H01	3/70	1SFA611101R1103	MP2-11Y	2/17	1SFA611103R2105	MP4-21W	2/18
1SFA193110R9006	P9MSCZ3C01	3/70	1SFA611101R1104	MP2-11L	2/17	1SFA611103R2108	MP4-21C	2/18
1SFA193335R9006	P9MSCX0Z01	3/71	1SFA611101R1105	MP2-11W	2/17	1SFA611103R3002	MP4-30G	2/16
1SFA197001R1015	P9PLNVDB	3/79	1SFA611101R1108	MP2-11C	2/17	1SFA611103R3006	MP4-30B	2/16
1SFA197002R1013	P9PLNVDG	3/79	1SFA611101R2001	MP2-20R	2/15	1SFA611103R3101	MP4-31R	2/18
1SFA197003R1014	P9PLNVDL	3/79	1SFA611101R2002	MP2-20G	2/15	1SFA611103R3102	MP4-31G	2/18
1SFA197004R1011	P9PLNVDR	3/79	1SFA611101R2004	MP2-20L	2/15	1SFA611103R3104	MP4-31L	2/18
1SFA197005R1012	P9PLNVDV	3/79	1SFA611101R2005	MP2-20W	2/15	1SFA611103R3108	MP4-31C	2/18
1SFA197007R1045	P9PLNVJB	3/79	1SFA611101R2006	MP2-20B	2/15	1SFA611124R1001	MPM1-10R	2/22
1SFA197008R1043	P9PLNVJG	3/79	1SFA611101R2101	MP2-21R	2/17	1SFA611124R1002	MPM1-10G	2/22
1SFA197009R1044	P9PLNVJL	3/79	1SFA611101R2102	MP2-21G	2/17	1SFA611124R1003	MPM1-10Y	2/22
1SFA197010R1041	P9PLNVJR	3/79	1SFA611101R2103	MP2-21Y	2/17	1SFA611124R1006	MPM1-10B	2/22
1SFA197011R1042	P9PLNVJV	3/79	1SFA611101R2104	MP2-21L	2/17	1SFA611124R1101	MPM1-11R	2/22
1SFA197013R1075	P9PLNVNB	3/79	1SFA611101R2105	MP2-21W	2/17	1SFA611124R1102	MPM1-11G	2/22
1SFA197014R1073	P9PLNVNG	3/79	1SFA611101R3001	MP2-30R	2/15	1SFA611124R1103	MPM1-11Y	2/22
1SFA197015R1074	P9PLNVNL	3/79	1SFA611101R3002	MP2-30G	2/15	1SFA611125R1001	MPM2-10R	2/22
1SFA197016R1071	P9PLNVNR	3/79	1SFA611101R3003	MP2-30Y	2/15	1SFA611125R1003	MPM2-10Y	2/22
1SFA197017R1072	P9PLNVNV	3/79	1SFA611101R3004	MP2-30L	2/15	1SFA611125R1006	MPM2-10B	2/22
1SFA197018R1019	P9PLFVDA	3/79	1SFA611101R3006	MP2-30B	2/15	1SFA611125R1101	MPM2-11R	2/22
1SFA197019R1015	P9PLFVDB	3/79	1SFA611101R3101	MP2-31R	2/17	1SFA611125R1103	MPM2-11Y	2/22
1SFA197020R1013	P9PLFVDG	3/79	1SFA611101R3102	MP2-31G	2/17	1SFA611130R1101	MPD1-11R	2/20

Index

Order code classification

Order code	Type	Page	Order code	Type	Page	Order code	Type	Page
1SFA611130R1102	MPD1-11G	2/20	1SFA611200R3101	M2SS1-31R	2/32	1SFA611204R3101	M2SS5-31R	2/33
1SFA611130R1103	MPD1-11Y	2/20	1SFA611200R3102	M2SS1-31G	2/32	1SFA611204R3102	M2SS5-31G	2/33
1SFA611130R1106	MPD1-11B	2/19	1SFA611200R3103	M2SS1-31Y	2/32	1SFA611204R3103	M2SS5-31Y	2/33
1SFA611130R1108	MPD1-11C	2/20	1SFA611200R3108	M2SS1-31C	2/32	1SFA611204R3104	M2SS5-31L	2/33
1SFA611131R1101	MPD2-11R	2/20	1SFA611201R1001	M2SS2-10R	2/26	1SFA611204R3108	M2SS5-31C	2/33
1SFA611131R1102	MPD2-11G	2/20	1SFA611201R1006	M2SS2-10B	2/26	1SFA611205R1001	M2SS6-10R	2/27
1SFA611131R1103	MPD2-11Y	2/20	1SFA611201R1007	M2SS2-10U	2/26	1SFA611205R1006	M2SS6-10B	2/27
1SFA611131R1106	MPD2-11B	2/19	1SFA611201R1101	M2SS2-11R	2/32	1SFA611205R1007	M2SS6-10U	2/27
1SFA611131R1108	MPD2-11C	2/20	1SFA611201R1102	M2SS2-11G	2/32	1SFA611205R1101	M2SS6-11R	2/33
1SFA611132R1101	MPD3-11R	2/20	1SFA611201R1103	M2SS2-11Y	2/32	1SFA611205R1102	M2SS6-11G	2/33
1SFA611132R1102	MPD3-11G	2/20	1SFA611201R1104	M2SS2-11L	2/32	1SFA611205R1103	M2SS6-11Y	2/33
1SFA611132R1103	MPD3-11Y	2/20	1SFA611201R1108	M2SS2-11C	2/32	1SFA611205R1104	M2SS6-11L	2/33
1SFA611132R1106	MPD3-11B	2/19	1SFA611201R2001	M2SS2-20R	2/26	1SFA611205R1108	M2SS6-11C	2/33
1SFA611132R1108	MPD3-11C	2/20	1SFA611201R2006	M2SS2-20B	2/26	1SFA611205R2006	M2SS6-20B	2/27
1SFA611133R1101	MPD4-11R	2/20	1SFA611201R2007	M2SS2-20U	2/26	1SFA611205R2007	M2SS6-20U	2/27
1SFA611133R1102	MPD4-11G	2/20	1SFA611201R2101	M2SS2-21R	2/32	1SFA611205R3006	M2SS6-30B	2/27
1SFA611133R1103	MPD4-11Y	2/20	1SFA611201R2102	M2SS2-21G	2/32	1SFA611205R3108	M2SS6-31C	2/33
1SFA611133R1106	MPD4-11B	2/19	1SFA611201R2103	M2SS2-21Y	2/32	1SFA611210R1001	M3SS1-10R	2/28
1SFA611133R1108	MPD4-11C	2/20	1SFA611201R2104	M2SS2-21L	2/32	1SFA611210R1006	M3SS1-21L	2/28
1SFA611134R1101	MPD5-11R	2/20	1SFA611201R2108	M2SS2-21C	2/32	1SFA611210R1007	M3SS1-10U	2/28
1SFA611134R1102	MPD5-11G	2/20	1SFA611201R3001	M2SS2-30R	2/26	1SFA611210R1101	M3SS1-11R	2/34
1SFA611134R1103	MPD5-11Y	2/20	1SFA611201R3006	M2SS2-30B	2/26	1SFA611210R1102	M3SS1-11G	2/34
1SFA611134R1106	MPD5-11B	2/19	1SFA611201R3007	M2SS2-30U	2/26	1SFA611210R1103	M3SS1-11Y	2/34
1SFA611134R1108	MPD5-11C	2/20	1SFA611201R3101	M2SS2-31R	2/32	1SFA611210R1104	M3SS1-11L	2/34
1SFA611135R1102	MPD6-11G	2/20	1SFA611201R3102	M2SS2-31G	2/32	1SFA611210R1108	M3SS1-11C	2/34
1SFA611135R1106	MPD6-11B	2/19	1SFA611201R3103	M2SS2-31Y	2/32	1SFA611210R2001	M3SS1-20R	2/28
1SFA611135R1108	MPD6-11C	2/20	1SFA611201R3104	M2SS2-31L	2/32	1SFA611210R2006	M3SS1-20B	2/28
1SFA611136R1102	MPD7-11G	2/20	1SFA611201R3108	M2SS2-31C	2/32	1SFA611210R2007	M3SS1-20U	2/28
1SFA611136R1106	MPD7-11B	2/19	1SFA611202R1001	M2SS3-10R	2/26	1SFA611210R2101	M3SS1-21R	2/34
1SFA611137R1102	MPD8-11G	2/20	1SFA611202R1006	M2SS3-10B	2/26	1SFA611210R2102	M3SS1-21G	2/34
1SFA611137R1106	MPD8-11B	2/19	1SFA611202R1007	M2SS3-10U	2/26	1SFA611210R2103	M3SS1-21Y	2/34
1SFA611137R1108	MPD8-11C	2/20	1SFA611202R1101	M2SS3-11R	2/32	1SFA611210R2104	M3SS1-21L	2/34
1SFA611138R1106	MPD9-11B	2/19	1SFA611202R1102	M2SS3-11G	2/32	1SFA611210R2108	M3SS1-21C	2/34
1SFA611141R1101	MPD12-11R	2/21	1SFA611202R1103	M2SS3-11Y	2/32	1SFA611210R3001	M3SS1-30R	2/28
1SFA611141R1102	MPD12-11G	2/21	1SFA611202R1104	M2SS3-11L	2/32	1SFA611210R3006	M3SS1-30B	2/28
1SFA611141R1103	MPD12-11Y	2/21	1SFA611202R1108	M2SS3-11C	2/32	1SFA611210R3007	M3SS1-30U	2/28
1SFA611141R1106	MPD12-11B	2/19	1SFA611202R2001	M2SS3-20R	2/26	1SFA611210R3101	M3SS1-31R	2/34
1SFA611141R1108	MPD12-11C	2/21	1SFA611202R2006	M2SS3-20B	2/26	1SFA611210R3102	M3SS1-31G	2/34
1SFA611142R1101	MPD13-11R	2/21	1SFA611202R2007	M2SS3-20U	2/26	1SFA611210R3103	M3SS1-31Y	2/34
1SFA611142R1102	MPD13-11G	2/21	1SFA611202R2101	M2SS3-21R	2/32	1SFA611210R3104	M3SS1-31L	2/34
1SFA611142R1103	MPD13-11Y	2/21	1SFA611202R2102	M2SS3-21G	2/32	1SFA611210R3108	M3SS1-31C	2/34
1SFA611142R1106	MPD13-11B	2/19	1SFA611202R3001	M2SS3-30R	2/26	1SFA611211R1001	M3SS2-10R	2/28
1SFA611142R1108	MPD13-11C	2/21	1SFA611202R3006	M2SS3-30B	2/26	1SFA611211R1006	M3SS2-10B	2/28
1SFA611143R1101	MPD14-11R	2/21	1SFA611202R3101	M2SS3-31R	2/32	1SFA611211R1007	M3SS2-10U	2/28
1SFA611143R1102	MPD14-11G	2/21	1SFA611202R3102	M2SS3-31G	2/32	1SFA611211R1101	M3SS2-11R	2/34
1SFA611143R1103	MPD14-11Y	2/21	1SFA611202R3103	M2SS3-31Y	2/32	1SFA611211R1102	M3SS2-11G	2/34
1SFA611143R1106	MPD14-11B	2/19	1SFA611202R3108	M2SS3-31C	2/32	1SFA611211R1103	M3SS2-11Y	2/34
1SFA611143R1108	MPD14-11C	2/21	1SFA611202R3101	M2SS4-10R	2/27	1SFA611211R1104	M3SS2-11L	2/34
1SFA611144R1101	MPD15-11R	2/21	1SFA611203R1006	M2SS4-10B	2/27	1SFA611211R1108	M3SS2-11C	2/34
1SFA611144R1102	MPD15-11G	2/21	1SFA611203R1007	M2SS4-10U	2/27	1SFA611211R2001	M3SS2-20R	2/28
1SFA611144R1103	MPD15-11Y	2/21	1SFA611203R1101	M2SS4-11R	2/33	1SFA611211R2006	M3SS2-20B	2/28
1SFA611144R1106	MPD15-11B	2/19	1SFA611203R1102	M2SS4-11G	2/33	1SFA611211R2007	M3SS2-20U	2/28
1SFA611144R1108	MPD15-11C	2/21	1SFA611203R1103	M2SS4-11Y	2/33	1SFA611211R2101	M3SS2-21R	2/34
1SFA611145R1101	MPD16-11R	2/21	1SFA611203R1104	M2SS4-11L	2/33	1SFA611211R2102	M3SS2-21G	2/34
1SFA611145R1102	MPD16-11G	2/21	1SFA611203R1108	M2SS4-11C	2/33	1SFA611211R2103	M3SS2-21Y	2/34
1SFA611145R1103	MPD16-11Y	2/21	1SFA611203R2001	M2SS4-20R	2/27	1SFA611211R2104	M3SS2-21L	2/34
1SFA611145R1106	MPD16-11B	2/19	1SFA611203R2006	M2SS4-20B	2/27	1SFA611211R2108	M3SS2-21C	2/34
1SFA611145R1108	MPD16-11C	2/21	1SFA611203R2007	M2SS4-20U	2/27	1SFA611211R3001	M3SS2-30R	2/28
1SFA611146R1102	MPD17-11G	2/21	1SFA611203R2101	M2SS4-21R	2/33	1SFA611211R3006	M3SS2-30B	2/28
1SFA611146R1103	MPD17-11Y	2/21	1SFA611203R2102	M2SS4-21G	2/33	1SFA611211R3101	M3SS2-31R	2/34
1SFA611146R1106	MPD17-11B	2/19	1SFA611203R2103	M2SS4-21Y	2/33	1SFA611211R3102	M3SS2-31G	2/34
1SFA611146R1108	MPD17-11C	2/21	1SFA611203R2104	M2SS4-21L	2/33	1SFA611211R3104	M3SS2-31L	2/34
1SFA611147R1106	MPD18-11B	2/19	1SFA611203R2108	M2SS4-21C	2/33	1SFA611211R3108	M3SS2-31C	2/34
1SFA611148R1102	MPD19-11G	2/21	1SFA611203R3006	M2SS4-30B	2/27	1SFA611212R1001	M3SS3-10R	2/28
1SFA611148R1106	MPD19-11B	2/19	1SFA611203R3102	M2SS4-31G	2/33	1SFA611212R1006	M3SS3-10B	2/28
1SFA611148R1108	MPD19-11C	2/21	1SFA611203R3108	M2SS4-31C	2/33	1SFA611212R1007	M3SS3-10U	2/28
1SFA611200R1001	M2SS1-10R	2/26	1SFA611204R1001	M2SS5-10R	2/27	1SFA611212R1101	M3SS3-11R	2/34
1SFA611200R1006	M2SS1-10B	2/26	1SFA611204R1006	M2SS5-10B	2/27	1SFA611212R1102	M3SS3-11G	2/34
1SFA611200R1007	M2SS1-10U	2/26	1SFA611204R1007	M2SS5-10U	2/27	1SFA611212R1103	M3SS3-11Y	2/34
1SFA611200R1101	M2SS1-11R	2/32	1SFA611204R1101	M2SS5-11R	2/33	1SFA611212R1104	M3SS3-11L	2/34
1SFA611200R1102	M2SS1-11G	2/32	1SFA611204R1102	M2SS5-11G	2/33	1SFA611212R1108	M3SS3-11C	2/34
1SFA611200R1103	M2SS1-11Y	2/32	1SFA611204R1103	M2SS5-11Y	2/33	1SFA611212R2006	M3SS3-20B	2/28
1SFA611200R1104	M2SS1-11L	2/32	1SFA611204R1104	M2SS5-11L	2/33	1SFA611212R2007	M3SS3-20U	2/28
1SFA611200R1108	M2SS1-11C	2/32	1SFA611204R1108	M2SS5-11C	2/33	1SFA611212R2101	M3SS3-21R	2/34
1SFA611200R2001	M2SS1-20R	2/26	1SFA611204R2001	M2SS5-20R	2/27	1SFA611212R2102	M3SS3-21G	2/34
1SFA611200R2006	M2SS1-20B	2/26	1SFA611204R2006	M2SS5-20B	2/27	1SFA611212R2108	M3SS3-21C	2/34
1SFA611200R2007	M2SS1-20U	2/26	1SFA611204R2007	M2SS5-20U	2/27	1SFA611212R3006	M3SS3-30B	2/28
1SFA611200R2101	M2SS1-21R	2/32	1SFA611204R2101	M2SS5-21R	2/33	1SFA611212R3108	M3SS3-31C	2/34
1SFA611200R2102	M2SS1-21G	2/32	1SFA611204R2102	M2SS5-21G	2/33	1SFA611213R1001	M3SS4-10R	2/29
1SFA611200R2103	M2SS1-21Y	2/32	1SFA611204R2103	M2SS5-21Y	2/33	1SFA611213R1006	M3SS4-10B	2/29
1SFA611200R2104	M2SS1-21L	2/32	1SFA611204R2104	M2SS5-21L	2/33	1SFA611213R1007	M3SS4-10U	2/29
1SFA611200R2108	M2SS1-21C	2/32	1SFA611204R2108	M2SS5-21C	2/33	1SFA611213R1101	M3SS4-11R	2/35
1SFA611200R3001	M2SS1-30R	2/26	1SFA611204R3001	M2SS5-30R	2/27	1SFA611213R1102	M3SS4-11G	2/35
1SFA611200R3006	M2SS1-30B	2/26	1SFA611204R3006	M2SS5-30B	2/27	1SFA611213R1103	M3SS4-11Y	2/35

Index

Order code classification

Order code	Type	Page
1SFA611213R1104	M3SS4-11L	2/35
1SFA611213R1108	M3SS4-11C	2/35
1SFA611213R2001	M3SS4-20R	2/29
1SFA611213R2006	M3SS4-20B	2/29
1SFA611213R2007	M3SS4-20U	2/29
1SFA611213R2101	M3SS4-21R	2/35
1SFA611213R2102	M3SS4-21G	2/35
1SFA611213R2103	M3SS4-21Y	2/35
1SFA611213R2104	M3SS4-21L	2/35
1SFA611213R2108	M3SS4-21C	2/35
1SFA611213R3006	M3SS4-30B	2/29
1SFA611213R3101	M3SS4-31R	2/35
1SFA611213R3108	M3SS4-31C	2/35
1SFA611214R1001	M3SS5-10R	2/29
1SFA611214R1006	M3SS5-10B	2/29
1SFA611214R1007	M3SS5-10U	2/29
1SFA611214R1101	M3SS5-11R	2/35
1SFA611214R1102	M3SS5-11G	2/35
1SFA611214R1103	M3SS5-11Y	2/35
1SFA611214R1104	M3SS5-11L	2/35
1SFA611214R1108	M3SS5-11C	2/35
1SFA611214R2006	M3SS5-20B	2/29
1SFA611214R2007	M3SS5-20U	2/29
1SFA611214R2101	M3SS5-21R	2/35
1SFA611214R2102	M3SS5-21G	2/35
1SFA611214R2103	M3SS5-21Y	2/35
1SFA611214R2104	M3SS5-21L	2/35
1SFA611214R2108	M3SS5-21C	2/35
1SFA611214R3001	M3SS5-30R	2/29
1SFA611214R3006	M3SS5-30B	2/29
1SFA611214R3102	M3SS5-31G	2/35
1SFA611214R3108	M3SS5-31C	2/35
1SFA611215R1001	M3SS6-10R	2/29
1SFA611215R1006	M3SS6-10B	2/29
1SFA611215R1007	M3SS6-10U	2/29
1SFA611215R1101	M3SS6-11R	2/35
1SFA611215R1102	M3SS6-11G	2/35
1SFA611215R1103	M3SS6-11Y	2/35
1SFA611215R1104	M3SS6-11L	2/35
1SFA611215R1108	M3SS6-11C	2/35
1SFA611215R2006	M3SS6-20B	2/29
1SFA611215R2102	M3SS6-21G	2/35
1SFA611215R2103	M3SS6-21Y	2/35
1SFA611215R3006	M3SS6-30B	2/29
1SFA611215R3104	M3SS6-31L	2/35
1SFA611216R1001	M3SS7-10R	2/28
1SFA611216R1006	M3SS7-10B	2/28
1SFA611216R1007	M3SS7-10U	2/28
1SFA611216R1101	M3SS7-11R	2/34
1SFA611216R1102	M3SS7-11G	2/34
1SFA611216R1103	M3SS7-11Y	2/34
1SFA611216R1104	M3SS7-11L	2/34
1SFA611216R1108	M3SS7-11C	2/34
1SFA611216R2001	M3SS7-20R	2/28
1SFA611216R2006	M3SS7-20B	2/28
1SFA611216R2102	M3SS7-21G	2/34
1SFA611216R2104	M3SS7-21L	2/34
1SFA611216R2108	M3SS7-21C	2/34
1SFA611216R3006	M3SS7-30B	2/28
1SFA611216R3102	M3SS7-31G	2/34
1SFA611216R3108	M3SS7-31C	2/34
1SFA611217R1001	M3SS8-10R	2/29
1SFA611217R1006	M3SS8-10B	2/29
1SFA611217R1007	M3SS8-10U	2/29
1SFA611217R1101	M3SS8-11R	2/35
1SFA611217R1102	M3SS8-11G	2/35
1SFA611217R1103	M3SS8-11Y	2/35
1SFA611217R1104	M3SS8-11L	2/35
1SFA611217R1108	M3SS8-11C	2/35
1SFA611217R2006	M3SS8-20B	2/29
1SFA611217R2101	M3SS8-21R	2/35
1SFA611217R2102	M3SS8-21G	2/35
1SFA611217R3006	M3SS8-30B	2/29
1SFA611217R3101	M3SS8-31R	2/35
1SFA611217R3102	M3SS8-31G	2/35
1SFA611220R1006	M2SSV1-10B	4/129
1SFA611221R1006	M2SSV2-10B	4/129
1SFA611222R1006	M2SSV3-10B	4/129
1SFA611230R1006	M3SSV1-10B	4/129
1SFA611231R1006	M3SSV2-10B	4/129
1SFA611232R1006	M3SSV3-10B	4/129
1SFA611250R1006	M3SSC1-10B	2/30
1SFA611250R3006	M3SSC1-30B	2/30
1SFA611251R1006	M3SSC2-10B	2/30

Order code	Type	Page
1SFA611251R3006	M3SSC2-30B	2/30
1SFA611252R1006	M3SSC3-10B	2/30
1SFA611252R3006	M3SSC3-30B	2/30
1SFA611256R1006	M3SSC7-10B	2/30
1SFA611256R3006	M3SSC7-30B	2/30
1SFA611280R1001	M2SSK1-101	2/36
1SFA611280R1002	M2SSK1-102	2/36
1SFA611280R1003	M2SSK1-103	2/36
1SFA611280R1004	M2SSK1-104	2/36
1SFA611280R2001	M2SSK1-201	2/36
1SFA611280R3001	M2SSK1-301	2/36
1SFA611280R3002	M2SSK1-302	2/36
1SFA611280R3003	M2SSK1-303	2/36
1SFA611280R3004	M2SSK1-304	2/36
1SFA611281R1001	M2SSK2-101	2/36
1SFA611281R1002	M2SSK2-102	2/36
1SFA611281R1003	M2SSK2-103	2/36
1SFA611281R1004	M2SSK2-104	2/36
1SFA611281R2001	M2SSK2-201	2/36
1SFA611281R2003	M2SSK2-203	2/36
1SFA611281R3001	M2SSK2-301	2/36
1SFA611281R3002	M2SSK2-302	2/36
1SFA611281R3003	M2SSK2-303	2/36
1SFA611281R3004	M2SSK2-304	2/36
1SFA611282R1001	M2SSK3-101	2/36
1SFA611282R1002	M2SSK3-102	2/36
1SFA611282R1003	M2SSK3-103	2/36
1SFA611282R1004	M2SSK3-104	2/36
1SFA611282R3001	M2SSK3-301	2/36
1SFA611282R3002	M2SSK3-302	2/36
1SFA611282R3003	M2SSK3-303	2/36
1SFA611282R3004	M2SSK3-304	2/36
1SFA611283R1001	M3SSK1-101	2/37
1SFA611283R1002	M3SSK1-102	2/37
1SFA611283R1003	M3SSK1-103	2/37
1SFA611283R1004	M3SSK1-104	2/37
1SFA611283R2001	M3SSK1-201	2/37
1SFA611283R3001	M3SSK1-301	2/37
1SFA611283R3002	M3SSK1-302	2/37
1SFA611283R3003	M3SSK1-303	2/37
1SFA611283R3004	M3SSK1-304	2/37
1SFA611284R1001	M3SSK2-101	2/37
1SFA611284R1002	M3SSK2-102	2/37
1SFA611284R1003	M3SSK2-103	2/37
1SFA611284R1004	M3SSK2-104	2/37
1SFA611284R3001	M3SSK2-301	2/37
1SFA611285R1001	M3SSK3-101	2/37
1SFA611285R1002	M3SSK3-102	2/37
1SFA611285R1003	M3SSK3-103	2/37
1SFA611285R1004	M3SSK3-104	2/37
1SFA611285R3001	M3SSK3-301	2/37
1SFA611285R3002	M3SSK3-302	2/37
1SFA611285R3003	M3SSK3-303	2/37
1SFA611286R1001	M3SSK4-101	2/37
1SFA611286R1002	M3SSK4-102	2/37
1SFA611286R3001	M3SSK4-301	2/37
1SFA611286R3002	M3SSK4-302	2/37
1SFA611287R1001	M3SSK5-101	2/37
1SFA611287R1003	M3SSK5-103	2/37
1SFA611287R3001	M3SSK5-301	2/37
1SFA611288R1001	M3SSK6-101	2/37
1SFA611289R1001	M2SSK4-101	2/36
1SFA611290R4001	M4SS1-10R	2/31
1SFA611290R4006	M4SS1-10B	2/31
1SFA611290R6001	M4SS1-30R	2/31
1SFA611290R6006	M4SS1-30B	2/31
1SFA611291R4001	M4SS2-10R	2/31
1SFA611291R4006	M4SS2-10B	2/31
1SFA611291R6001	M4SS2-30R	2/31
1SFA611291R6006	M4SS2-30B	2/31
1SFA611300R1006	MTS1-10B	2/42
1SFA611300R2006	MTS1-20B	2/42
1SFA611300R3006	MTS1-30B	2/42
1SFA611301R1006	MTS2-10B	2/42
1SFA611301R2006	MTS2-20B	2/42
1SFA611301R3006	MTS2-30B	2/42
1SFA611302R1006	MTS3-10B	2/42
1SFA611302R2006	MTS3-20B	2/42
1SFA611302R3006	MTS3-30B	2/42
1SFA611400R1001	ML1-100R	2/25
1SFA611400R1002	ML1-100G	2/25
1SFA611400R1003	ML1-100Y	2/25
1SFA611400R1004	ML1-100L	2/25
1SFA611400R1005	ML1-100W	2/25

Order code	Type	Page
1SFA611400R1008	ML1-100C	2/25
1SFA611410R1006	MT-1B	2/38
1SFA611410R1056	MT-105B	2/38
1SFA611410R1106	MT-110B	2/38
1SFA611410R1506	MT-150B	2/38
1SFA611410R2056	MT-205B	2/38
1SFA611410R2106	MT-210B	2/38
1SFA611410R2506	MT-250B	2/38
1SFA611410R3006	MT-3B	2/38
1SFA611410R3056	MT-305B	2/38
1SFA611410R3106	MT-310B	2/38
1SFA611410R3506	MT-350B	2/38
1SFA611510R1101	MPMT3-11R	2/23
1SFA611511R1101	MPMP3-11R	2/23
1SFA611513R1001	MPMT4-10R	2/23
1SFA611513R1101	MPMT4-11R	2/23
1SFA611514R1001	MPMP4-10R	2/23
1SFA611514R1101	MPMP4-11R	2/23
1SFA611520R1001	MPET3-10R	2/23
1SFA611520R1006	MPET3-10B	2/24
1SFA611521R1001	MPPE3-10R	2/23
1SFA611521R3006	MPEP3-10B	2/24
1SFA611522R1101	MPEK3-11R	2/23
1SFA611522R1106	MPEK3-11B	2/24
1SFA611522R1201	MPEK3-12R	2/23
1SFA611522R1301	MPEK3-13R	2/23
1SFA611523R1001	MPET4-10R	2/23
1SFA611523R1006	MPET4-10B	2/24
1SFA611524R1001	MPEP4-10R	2/23
1SFA611524R1006	MPEP4-10B	2/24
1SFA611525R1101	MPEK4-11R	2/23
1SFA611525R1106	MPEK4-11B	2/24
1SFA611525R1201	MPEK4-12R	2/23
1SFA611525R1301	MPEK4-13R	2/23
1SFA611601R1100	MCBH5-00	2/44
1SFA611605R1100	MCBH-00	2/44
1SFA611610R1001	MCB-10	2/44
1SFA611610R1002	MCB-20	2/44
1SFA611610R1010	MCB-01	2/44
1SFA611610R1011	MCB-11	2/44
1SFA611610R1012	MCB-02	2/44
1SFA611610R1101	MCB-10G	2/44
1SFA611610R1102	MCB-20G	2/44
1SFA611610R1110	MCB-01G	2/44
1SFA611610R1111	MCB-11G	2/44
1SFA611610R1120	MCB-02G	2/44
1SFA611610R2001	MCB-10B	4/124
1SFA611610R2002	MCB-20B	4/124
1SFA611610R2010	MCB-01B	4/124
1SFA611610R2011	MCB-11B	4/124
1SFA611610R2020	MCB-02B	4/124
1SFA611610R2101	MCB-10BG	4/124
1SFA611610R2110	MCB-01BG	4/124
1SFA611612R1001	MCBL-01	2/44
1SFA611612R1010	MCBL-10	2/44
1SFA611612R1001	MLBL-00R	2/45
1SFA611612R1002	MLBL-00G	2/45
1SFA611612R1003	MLBL-00Y	2/45
1SFA611612R1004	MLBL-00L	2/45
1SFA611612R1005	MLBL-00W	2/45
1SFA611612R1011	MLBL-01R	2/45
1SFA611612R1012	MLBL-01G	2/45
1SFA611612R1013	MLBL-01Y	2/45
1SFA611612R1014	MLBL-01L	2/45
1SFA611612R1015	MLBL-01W	2/45
1SFA611612R1021	MLBL-02R	2/45
1SFA611612R1022	MLBL-02G	2/45
1SFA611612R1023	MLBL-02Y	2/45
1SFA611612R1024	MLBL-02L	2/45
1SFA611612R1025	MLBL-02W	2/45
1SFA611612R1031	MLBL-03R	2/45
1SFA611612R1032	MLBL-03G	2/45
1SFA611612R1033	MLBL-03Y	2/45
1SFA611612R1034	MLBL-03L	2/45
1SFA611612R1035	MLBL-03W	2/45
1SFA611612R1041	MLBL-04R	2/45
1SFA611612R1042	MLBL-04G	2/45
1SFA611612R1043	MLBL-04Y	2/45
1SFA611612R1044	MLBL-04L	2/45
1SFA611612R1045	MLBL-04W	2/45
1SFA611612R1051	MLBL-05R	2/45
1SFA611612R1052	MLBL-05G	2/45
1SFA611612R1053	MLBL-05Y	2/45
1SFA611612R1054	MLBL-05L	2/45

Index

Order code classification

Order code	Type	Page
1SFA611621R1055	MLBL-05W	2/45
1SFA611621R1061	MLBL-06R	2/45
1SFA611621R1062	MLBL-06G	2/45
1SFA611621R1063	MLBL-06Y	2/45
1SFA611621R1064	MLBL-06L	2/45
1SFA611621R1065	MLBL-06W	2/45
1SFA611621R1071	MLBL-07R	2/46
1SFA611621R1072	MLBL-07G	2/46
1SFA611621R1073	MLBL-07Y	2/46
1SFA611621R1074	MLBL-07L	2/46
1SFA611621R1075	MLBL-07W	2/46
1SFA611621R1081	MLBL-08R	2/46
1SFA611621R1082	MLBL-08G	2/46
1SFA611621R1083	MLBL-08Y	2/46
1SFA611621R1084	MLBL-08L	2/46
1SFA611621R1085	MLBL-08W	2/46
1SFA611621R1091	MLBL-09R	2/46
1SFA611621R1092	MLBL-09G	2/46
1SFA611621R1093	MLBL-09Y	2/46
1SFA611621R1094	MLBL-09L	2/46
1SFA611621R1095	MLBL-09W	2/46
1SFA611621R1991	MLBL-99R	2/46
1SFA611621R1992	MLBL-99G	2/46
1SFA611621R1993	MLBL-99Y	2/46
1SFA611621R1994	MLBL-99L	2/46
1SFA611621R1995	MLBL-99W	2/46
1SFA611621R2001	MLBL-00BR	4/125
1SFA611621R2002	MLBL-00BG	4/125
1SFA611621R2003	MLBL-00BY	4/125
1SFA611621R2004	MLBL-00BL	4/125
1SFA611621R2005	MLBL-00BW	4/125
1SFA611621R2011	MLBL-01BR	4/125
1SFA611621R2012	MLBL-01BG	4/125
1SFA611621R2013	MLBL-01BY	4/125
1SFA611621R2014	MLBL-01BL	4/125
1SFA611621R2015	MLBL-01BW	4/125
1SFA611621R2021	MLBL-02BR	4/125
1SFA611621R2022	MLBL-02BG	4/125
1SFA611621R2023	MLBL-02BY	4/125
1SFA611621R2024	MLBL-02BL	4/125
1SFA611621R2025	MLBL-02BW	4/125
1SFA611621R2031	MLBL-03BR	4/125
1SFA611621R2032	MLBL-03BG	4/125
1SFA611621R2033	MLBL-03BY	4/125
1SFA611621R2034	MLBL-03BL	4/125
1SFA611621R2035	MLBL-03BW	4/125
1SFA611621R2041	MLBL-04BR	4/125
1SFA611621R2042	MLBL-04BG	4/125
1SFA611621R2043	MLBL-04BY	4/125
1SFA611621R2044	MLBL-04BL	4/125
1SFA611621R2045	MLBL-04BW	4/125
1SFA611621R2051	MLBL-05BR	4/125
1SFA611621R2052	MLBL-05BG	4/125
1SFA611621R2053	MLBL-05BY	4/125
1SFA611621R2054	MLBL-05BL	4/125
1SFA611621R2055	MLBL-05BW	4/125
1SFA611621R2061	MLBL-06BR	4/125
1SFA611621R2062	MLBL-06BG	4/125
1SFA611621R2063	MLBL-06BY	4/125
1SFA611621R2064	MLBL-06BL	4/125
1SFA611621R2065	MLBL-06BW	4/125
1SFA611621R2071	MLBL-07BR	4/126
1SFA611621R2072	MLBL-07BG	4/126
1SFA611621R2073	MLBL-07BY	4/126
1SFA611621R2074	MLBL-07BL	4/126
1SFA611621R2075	MLBL-07BW	4/126
1SFA611621R2081	MLBL-08BR	4/126
1SFA611621R2082	MLBL-08BG	4/126
1SFA611621R2083	MLBL-08BY	4/126
1SFA611621R2084	MLBL-08BL	4/126
1SFA611621R2085	MLBL-08BW	4/126
1SFA611621R2091	MLBL-09BR	4/126
1SFA611621R2092	MLBL-09BG	4/126
1SFA611621R2093	MLBL-09BY	4/126
1SFA611621R2094	MLBL-09BL	4/126
1SFA611621R2095	MLBL-09BW	4/126
1SFA611621R3041	MLBL-04AR	2/45
1SFA611621R3042	MLBL-04AG	2/45
1SFA611621R3043	MLBL-04AY	2/45
1SFA611621R3044	MLBL-04AL	2/45
1SFA611621R3045	MLBL-04AW	2/45
1SFA611630R1002	MDB-2	2/48
1SFA611701R4006	MJS1-40B	2/41
1SFA611701R6006	MJS1-60B	2/41

Order code	Type	Page
1SFA611702R4006	MJS2-40B	2/41
1SFA611702R6006	MJS2-60B	2/41
1SFA611703R4006	MJS3-40B	2/41
1SFA611703R6006	MJS3-60B	2/41
1SFA611704R4006	MJS4-40B	2/41
1SFA611704R6006	MJS4-60B	2/41
1SFA611705R4006	MJS5-40B	2/41
1SFA611705R6006	MJS5-60B	2/41
1SFA611706R4006	MJS6-40B	2/41
1SFA611706R6006	MJS6-60B	2/41
1SFA611707R4006	MJS7-40B	2/41
1SFA611707R6006	MJS7-60B	2/41
1SFA611708R4006	MJS8-40B	2/41
1SFA611708R6006	MJS8-60B	2/41
1SFA611709R4006	MJS9-40B	2/41
1SFA611709R6006	MJS9-60B	2/41
1SFA611710R6006	MJS10-60B	2/41
1SFA611711R4006	MJS11-40B	2/41
1SFA611711R6006	MJS11-60B	2/41
1SFA611712R4006	MJS12-40B	2/41
1SFA611712R6006	MJS12-60B	2/41
1SFA611811R1000	MEP1-0	4/123
1SFA611812R1000	MEP2-0	4/123
1SFA611812R1001	MEP2-1001	4/130
1SFA611813R1000	MEP3-0	4/123
1SFA611814R1000	MEP4-0	4/123
1SFA611816R1000	MEP6-0	4/123
1SFA611821R1000	MEPY1-0	4/123
1SFA611821R1035	MEPY1-1035	4/130
1SFA611821R1040	MEPY1-1040	4/130
1SFA611821R1041	MEPY1-1041	4/130
1SFA611821R1042	MEPY1-1042	4/130
1SFA611920H8150	MA1-8150	4/124
1SFA611920R8001	MA1-8001	2/48
1SFA611920R8002	MA1-8002	2/47
1SFA611920R8002	MA1-8002	3/110
1SFA611920R8015	MA1-8015	2/48
1SFA611920R8015	MA1-8015	3/111
1SFA611920R8019	MA1-8019	2/48
1SFA611920R8019	MA1-8019	3/111
1SFA611920R8052	MA1-8052	2/47
1SFA611920R8052	MA1-8052	3/110
1SFA611920R8053	MA1-8053	2/47
1SFA611920R8053	MA1-8053	4/123
1SFA611920R8074	MA1-8074	2/47
1SFA611920R8074	MA1-8074	3/110
1SFA611920R8126	MA1-8126	2/47
1SFA611920R8126	MA1-8128	2/47
1SFA611920R8128	MA1-8128	4/123
1SFA611920R8129	MA1-8129	4/124
1SFA611920R8130	MA1-8130	4/124
1SFA611920R8131	MA1-8131	2/48
1SFA611920R8136	MA1-8136	4/124
1SFA611920R8137	MA1-8137	2/41
1SFA611920R8138	MA1-8138	2/41
1SFA611920R8139	MA1-8139	2/19
1SFA611920R8139	MA1-8139	2/20
1SFA611920R8139	MA1-8139	2/21
1SFA611920R8149	MA1-8149	2/48
1SFA611920R8149	MA1-8149	3/111
1SFA611920R8152	MA1-8152	2/47
1SFA611920R8152	MA1-8152	3/110
1SFA611920R8153	MA1-8153	2/47
1SFA611920R8153	MA1-8153	3/110
1SFA611920R8160	MA1-8160	4/124
1SFA611925R3001	MA5-3001	4/124
1SFA611925R3002	MA5-3002	4/124
1SFA611925R3003	MA5-3003	4/124
1SFA611925R3004	MA5-3004	4/124
1SFA611925R3006	MA5-3006	4/124
1SFA611925R3007	MA5-3007	4/124
1SFA611925R3008	MA5-3008	4/124
1SFA611925R3009	MA5-3009	4/124
1SFA611925R3010	MA5-3010	4/124
1SFA611930R1000	MA6-1000	4/128
1SFA611930R1002	MA6-1002	4/128
1SFA611930R1003	MA6-1003	4/128
1SFA611930R1004	MA6-1004	4/128
1SFA611930R1005	MA6-1005	4/128
1SFA611930R1006	MA6-1006	4/128
1SFA611930R1007	MA6-1007	4/128
1SFA611930R1008	MA6-1008	4/128
1SFA611930R1009	MA6-1009	4/128
1SFA611930R1010	MA6-1010	5/136

Order code	Type	Page
1SFA611930R1011	MA6-1011	5/136
1SFA611930R1012	MA6-1012	4/128
1SFA611930R1013	MA6-1013	4/128
1SFA611930R1014	MA6-1014	4/128
1SFA611930R1015	MA6-1015	4/128
1SFA611930R1016	MA6-1016	4/128
1SFA611930R1017	MA6-1017	5/136
1SFA611930R1018	MA6-1018	5/136
1SFA611930R1019	MA6-1019	5/136
1SFA611930R1020	MA6-1020	5/136
1SFA611930R1021	MA6-1021	5/136
1SFA611930R1022	MA6-1022	5/136
1SFA611930R1023	MA6-1023	5/136
1SFA611930R1024	MA6-1024	4/128
1SFA611930R1025	MA6-1025	4/128
1SFA611930R1026	MA6-1026	4/128
1SFA611930R1027	MA6-1027	4/128
1SFA611930R1028	MA6-1028	4/128
1SFA611930R1029	MA6-1029	4/128
1SFA611930R1032	MA6-1032	5/135
1SFA611930R1033	MA6-1033	5/135
1SFA611930R1034	MA6-1034	5/135
1SFA611930R1035	MA6-1035	5/135
1SFA611930R1036	MA6-1036	5/135
1SFA611930R1037	MA6-1037	5/135
1SFA611930R1038	MA6-1038	5/135
1SFA611930R1039	MA6-1039	5/135
1SFA611930R1040	MA6-1040	5/135
1SFA611930R1041	MA6-1041	5/135
1SFA611930R1042	MA6-1042	5/135
1SFA611930R1043	MA6-1043	5/135
1SFA611930R1044	MA6-1044	5/135
1SFA611930R1045	MA6-1045	5/135
1SFA611930R1047	MA6-1047	5/135
1SFA611930R1054	MA6-1054	5/135
1SFA611930R1058	MA6-1058	5/135
1SFA611930R1060	MA6-1060	4/127
1SFA611930R1061	MA6-1061	4/127
1SFA611930R1062	MA6-1062	4/127
1SFA611930R1063	MA6-1063	4/127
1SFA611930R1064	MA6-1064	4/127
1SFA611930R1065	MA6-1065	4/127
1SFA611930R1070	MA6-1070	5/135
1SFA611930R1071	MA6-1071	5/135
1SFA611930R1073	MA6-1073	5/135
1SFA611930R1074	MA6-1074	5/135
1SFA611930R1075	MA6-1075	5/135
1SFA611930R1076	MA6-1076	5/135
1SFA611930R1077	MA6-1077	5/135
1SFA611930R1079	MA6-1079	5/135
1SFA611930R1080	MA6-1080	5/135
1SFA611930R1082	MA6-1082	5/135
1SFA611930R1083	MA6-1083	5/135
1SFA611930R1084	MA6-1084	5/135
1SFA611930R1085	MA6-1085	5/135
1SFA611930R1086	MA6-1086	5/135
1SFA611930R1087	MA6-1087	5/135
1SFA611930R1100	MA6-1100	4/128
1SFA611930R1101	MA6-1101	4/128
1SFA611930R1102	MA6-1102	4/128
1SFA611930R1103	MA6-1103	4/128
1SFA611930R1104	MA6-1104	4/128
1SFA611930R1118	MA6-1118	5/135
1SFA611930R1130	MA6-1130	4/127
1SFA611930R1131	MA6-1131	4/127
1SFA611930R1132	MA6-1132	4/127
1SFA611930R1133	MA6-1133	4/127
1SFA611930R1134	MA6-1134	4/127
1SFA611930R1135	MA6-1135	4/127
1SFA611930R1136	MA6-1136	4/127
1SFA611930R1137	MA6-1137	4/127
1SFA611930R1138	MA6-1138	4/127
1SFA611930R1139	MA6-1139	4/127
1SFA611930R1140	MA6-1140	4/127
1SFA611930R1141	MA6-1141	4/127
1SFA611930R1152	MA6-1152	4/127
1SFA611930R1153	MA6-1153	4/127
1SFA611930R1170	MA6-1170	4/127
1SFA611930R1171	MA6-1171	4/127
1SFA611930R1172	MA6-1172	4/127
1SFA611930R1173	MA6-1173	4/127
1SFA611930R1174	MA6-1174	4/127
1SFA611930R1175	MA6-1175	4/127
1SFA611930R1176	MA6-1176	4/127

Index

Order code classification

Order code	Type	Page
1SFA611930R1177	MA6-1177	4/127
1SFA611930R1178	MA6-1178	4/127
1SFA611930R1179	MA6-1179	4/127
1SFA611930R1190	MA6-1190	4/127
1SFA611930R1191	MA6-1191	4/127
1SFA611930R1192	MA6-1192	4/127
1SFA611930R1193	MA6-1193	4/127
1SFA611930R1194	MA6-1194	4/127
1SFA611930R1210	MA6-1210	5/135
1SFA611930R1240	MA6-1240	2/41
1SFA611930R1241	MA6-1241	2/41
1SFA611930R1242	MA6-1242	2/41
1SFA611930R1252	MA6-1252	2/38
1SFA611940R1000	MA16-1000	5/137
1SFA611940R1001	MA16-1001	5/137
1SFA616070R3051	KL70-305R	6/143
1SFA616070R3052	KL70-305G	6/143
1SFA616070R3053	KL70-305Y	6/143
1SFA616070R3054	KL70-305L	6/143
1SFA616070R3058	KL70-305C	6/143
1SFA616070R3061	KL70-306R	6/143
1SFA616070R3062	KL70-306G	6/143
1SFA616070R3063	KL70-306Y	6/143
1SFA616070R3064	KL70-306L	6/143
1SFA616070R3068	KL70-306C	6/143
1SFA616070R3071	KL70-307R	6/143
1SFA616070R3072	KL70-307G	6/143
1SFA616070R3073	KL70-307Y	6/143
1SFA616070R3074	KL70-307L	6/143
1SFA616070R3078	KL70-307C	6/143
1SFA616070R3421	KL70-342R	6/143
1SFA616070R3422	KL70-342G	6/143
1SFA616070R3423	KL70-342Y	6/143
1SFA616070R3424	KL70-342L	6/143
1SFA616070R3428	KL70-342C	6/143
1SFA616070R3521	KL70-352R	6/143
1SFA616070R3522	KL70-352G	6/143
1SFA616070R3523	KL70-352Y	6/143
1SFA616070R3524	KL70-352L	6/143
1SFA616070R3528	KL70-352C	6/143
1SFA616070R4011	KL70-401R	6/143
1SFA616070R4012	KL70-401G	6/143
1SFA616070R4013	KL70-401Y	6/143
1SFA616070R4014	KL70-401L	6/143
1SFA616070R4018	KL70-401C	6/143
1SFA616071R1201	KB70-1201	6/144
1SFA616071R3001	KB70-3001	6/144
1SFA616071R3101	KB70-3101	6/144
1SFA616073R1104	K570-1104	6/144
1SFA616073R1204	K570-1204	6/144
1SFA616073R2002	K570-2002	6/144
1SFA616073R2004	K570-2004	6/144
1SFA616073R3004	K570-3004	6/144
1SFA616075R1001	KT70-1001	6/145
1SFA616075R1002	KT70-1002	6/145
1SFA616077R1001	KA70-1001	6/145
1SFA616077R1002	KA70-1002	6/145
1SFA616077R1011	KA70-1011	6/145
1SFA616077R1012	KA70-1012	6/145
1SFA616077R1013	KA70-1013	6/145
1SFA616077R1021	KA70-1021	6/145
1SFA616077R1022	KA70-1022	6/145
1SFA616077R1023	KA70-1023	6/145
1SFA616077R1031	KA70-1031	6/145
1SFA616077R1032	KA70-1032	6/145
1SFA616077R1033	KA70-1033	6/145
1SFA616077R1034	KA70-1034	6/145
1SFA616080R1131	K5B-113R	6/146
1SFA616080R1132	K5B-113G	6/146
1SFA616080R1133	K5B-113Y	6/146
1SFA616080R1134	K5B-113L	6/146
1SFA616080R1138	K5B-113C	6/146
1SFA616080R1151	K5B-115R	6/146
1SFA616080R1152	K5B-115G	6/146
1SFA616080R1153	K5B-115Y	6/146
1SFA616080R1231	K5B-123R	6/146
1SFA616080R1232	K5B-123G	6/146
1SFA616080R1233	K5B-123Y	6/146
1SFA616080R1234	K5B-123L	6/146
1SFA616080R1238	K5B-123C	6/146
1SFA616080R2031	K5B-203R	6/146
1SFA616080R2032	K5B-203G	6/146
1SFA616080R2033	K5B-203Y	6/146
1SFA616080R2034	K5B-203L	6/146

Order code	Type	Page
1SFA616080R2038	K5B-203C	6/146
1SFA616080R3051	K5B-305R	6/146
1SFA616080R3052	K5B-305G	6/146
1SFA616080R3053	K5B-305Y	6/146
1SFA616080R3061	K5B-306R	6/146
1SFA616080R3062	K5B-306G	6/146
1SFA616080R3063	K5B-306Y	6/146
1SFA616080R3071	K5B-307R	6/146
1SFA616080R3072	K5B-307G	6/146
1SFA616080R3073	K5B-307Y	6/146
1SFA616080R4011	K5B-401R	6/146
1SFA616080R4012	K5B-401G	6/146
1SFA616080R4013	K5B-401Y	6/146
1SFA616080R4014	K5B-401L	6/146
1SFA616080R4018	K5B-401C	6/146
1SFA616087R1000	KASB-1000	6/146
1SFA616105R4001	KP6-40R	2/25
1SFA616105R4002	KP6-40G	2/25
1SFA616105R4006	KP6-40B	2/25
1SFA616160R1001	KPR1-100R	2/39
1SFA616160R1002	KPR1-100G	2/39
1SFA616160R1003	KPR1-100Y	2/39
1SFA616160R1004	KPR1-100L	2/39
1SFA616160R1005	KPR1-100W	2/39
1SFA616160R1006	KPR1-100B	2/39
1SFA616160R1014	KPR1-101L	2/39
1SFA616160R1015	KPR1-101W	2/39
1SFA616160R1022	KPR1-102G	2/39
1SFA616160R1025	KPR1-102W	2/39
1SFA616160R1035	KPR1-103W	2/39
1SFA616160R1046	KPR1-104B	2/39
1SFA616161R1001	KPR2-100R	2/39
1SFA616161R1006	KPR2-100B	2/39
1SFA616161R1051	KPR2-105R	2/39
1SFA616162R1001	KPR3-100R	2/40
1SFA616162R1002	KPR3-100G	2/40
1SFA616162R1003	KPR3-100Y	2/40
1SFA616162R1004	KPR3-100L	2/40
1SFA616162R1005	KPR3-100W	2/40
1SFA616162R1006	KPR3-100B	2/40
1SFA616162R1014	KPR3-101L	2/40
1SFA616162R1015	KPR3-101W	2/40
1SFA616162R1032	KPR3-103G	2/40
1SFA616162R1046	KPR3-104B	2/40
1SFA616163R1001	KPR4-100R	2/40
1SFA616163R1006	KPR4-100B	2/40
1SFA616163R1051	KPR4-105R	2/40
1SFA616901R1019	KTC1-1019	5/138
1SFA616901R1020	KTC1-1020	5/138
1SFA616901R1025	KTC1-1025	5/138
1SFA616901R1031	KTC1-1031	5/138
1SFA616901R1039	KTC1-1039	5/138
1SFA616901R9000	KTC1-9000	5/138
1SFA616901R9002	KTC1-9002	5/138
1SFA616901R9003	KTC1-9003	5/138
1SFA616901R9004	KTC1-9004	5/138
1SFA616901R9005	KTC1-9005	5/138
1SFA616901R9006	KTC1-9006	5/138
1SFA616901R9009	KTC1-9009	5/138
1SFA616901R9016	KTC1-9016	5/138
1SFA616901R9020	KTC1-9020	5/138
1SFA616901R9026	KTC1-9026	5/138
1SFA616901R9028	KTC1-9028	5/138
1SFA616902R1020	KTC2-1020	5/138
1SFA616902R1025	KTC2-1025	5/138
1SFA616902R1031	KTC2-1031	5/138
1SFA616902R9000	KTC2-9000	5/138
1SFA616902R9002	KTC2-9002	5/138
1SFA616902R9003	KTC2-9003	5/138
1SFA616902R9005	KTC2-9005	5/138
1SFA616902R9006	KTC2-9006	5/138
1SFA616902R9015	KTC2-9015	5/138
1SFA616902R9016	KTC2-9016	5/138
1SFA616902R9028	KTC2-9028	5/138
1SFA616903R1019	KTC3-1019	5/138
1SFA616903R1020	KTC3-1020	5/138
1SFA616903R1039	KTC3-1039	5/138
1SFA616903R9000	KTC3-9000	5/138
1SFA616903R9002	KTC3-9002	5/138
1SFA616904R1047	KTC4-1047	5/138
1SFA616904R9004	KTC4-9004	5/138
1SFA616905R1040	KTC5-1040	5/138
1SFA616905R1047	KTC5-1047	5/138

Order code	Type	Page
1SFA616905R9004	KTC5-9004	5/138
1SFA616906R1039	KTC6-1039	5/138
1SFA616906R1042	KTC6-1042	5/138
1SFA616906R9002	KTC6-9002	5/138
1SFA616908R1039	KTC8-1039	5/138
1SFA616908R9002	KTC8-9002	5/138
1SFA616908R9003	KTC8-9003	5/138
1SFA616908R9004	KTC8-9004	5/138
1SFA616908R9005	KTC8-9005	5/138
1SFA616908R9011	KTC8-9011	5/138
1SFA616908R9012	KTC8-9012	5/138
1SFA616908R9015	KTC8-9015	5/138
1SFA616908R9016	KTC8-9016	5/138
1SFA616908R9018	KTC8-9018	5/138
1SFA616908R9026	KTC8-9026	5/138
1SFA616915R1005	KTC15-1005	5/136
1SFA616915R1038	KTC15-1038	5/136
1SFA616915R6005	KTC15-6005	5/136
1SFA616920R8005	KA1-8005	2/25
1SFA616920R8010	KA1-8010	2/47
1SFA616920R8010	KA1-8010	3/110
1SFA616920R8020	KA1-8020	2/47
1SFA616920R8020	KA1-8020	3/110
1SFA616920R8021	KA1-8021	2/47
1SFA616920R8021	KA1-8021	3/110
1SFA616920R8022	KA1-8022	2/47
1SFA616920R8022	KA1-8022	3/110
1SFA616920R8024	KA1-8024	2/47
1SFA616920R8027	KA1-8027	2/47
1SFA616920R8027	KA1-8027	3/110
1SFA616920R8028	KA1-8028	2/47
1SFA616920R8028	KA1-8028	3/110
1SFA616920R8029	KA1-8029	2/47
1SFA616920R8029	KA1-8029	3/110
1SFA616920R8045	KA1-8045	4/124
1SFA616920R8046	KA1-8046	2/39
1SFA616920R8047	KA1-8047	2/39
1SFA616920R8072	KA1-8072	3/110
1SFA616920R8073	KA1-8073	2/47
1SFA616920R8073	KA1-8073	3/110
1SFA616920R8080	KA1-8080	2/47
1SFA616920R8120	KA1-8120	5/135
1SFA616920R8121	KA1-8121	5/135
1SFA616921R2011	KA2-2011	3/106
1SFA616921R2012	KA2-2012	3/106
1SFA616921R2013	KA2-2013	3/106
1SFA616921R2014	KA2-2014	3/106
1SFA616921R2015	KA2-2015	3/106
1SFA616921R2021	KA2-2021	3/106
1SFA616921R2022	KA2-2022	3/106
1SFA616921R2023	KA2-2023	3/106
1SFA616921R2024	KA2-2024	3/106
1SFA616921R2025	KA2-2025	3/106
1SFA616921R2031	KA2-2031	3/106
1SFA616921R2032	KA2-2032	3/106
1SFA616921R2033	KA2-2033	3/106
1SFA616921R2034	KA2-2034	3/106
1SFA616921R2035	KA2-2035	3/106
1SFA616921R2041	KA2-2041	3/106
1SFA616921R2042	KA2-2042	3/106
1SFA616921R2043	KA2-2043	3/106
1SFA616921R2044	KA2-2044	3/106
1SFA616921R2045	KA2-2045	3/106
1SFA616921R2051	KA2-2051	3/106
1SFA616921R2052	KA2-2052	3/106
1SFA616921R2053	KA2-2053	3/106
1SFA616921R2054	KA2-2054	3/106
1SFA616921R2055	KA2-2055	3/106
1SFA616921R2131	KA2-2131	3/106
1SFA616921R2132	KA2-2132	3/106
1SFA616921R2133	KA2-2133	3/106
1SFA616921R2134	KA2-2134	3/106
1SFA616921R2135	KA2-2135	3/106
1SFA616921R2141	KA2-2141	3/106
1SFA616921R2142	KA2-2142	3/106
1SFA616921R2143	KA2-2143	3/106
1SFA616921R2144	KA2-2144	3/106
1SFA616921R2145	KA2-2145	3/106
1SFA616921R2221	KA2-2221	3/106
1SFA616921R2222	KA2-2222	3/106
1SFA616921R2223	KA2-2223	3/106
1SFA616921R2224	KA2-2224	3/106
1SFA616921R2225	KA2-2225	3/106
1SFA616921R2231	KA2-2231	3/106

Index

Order code classification

Order code	Type	Page
1SFA616921R2232	KA2-2232	3/106
1SFA616921R2233	KA2-2233	3/106
1SFA616921R2234	KA2-2234	3/106
1SFA616921R2235	KA2-2235	3/106
1SFA616922R1018	KA3-1018	6/146
1SFA616922R1028	KA3-1028	6/146
1SFA616922R1118	KA3-1118	6/146
1SFA616922R1148	KA3-1148	6/146
1SFA616923R1028	KA4-1028	6/144
1SFA616923R1118	KA4-1118	6/144
1SFA616923R1148	KA4-1148	6/144
1SFA616924R1021	KA4-1021	6/144
1SFA616924R1022	KA4-1022	6/144
1SFA616924R1023	KA4-1023	6/144
1SFA616924R1024	KA4-1024	6/144
1SFA616924R1025	KA4-1025	6/144
1SFA619100R1011	CP1-10R-10	3/91
1SFA619100R1012	CP1-10G-10	3/91
1SFA619100R1013	CP1-10Y-10	3/91
1SFA619100R1014	CP1-10L-10	3/91
1SFA619100R1015	CP1-10W-10	3/91
1SFA619100R1016	CP1-10B-10	3/91
1SFA619100R1021	CP1-10R-20	3/91
1SFA619100R1022	CP1-10G-20	3/91
1SFA619100R1023	CP1-10Y-20	3/91
1SFA619100R1024	CP1-10L-20	3/91
1SFA619100R1025	CP1-10W-20	3/91
1SFA619100R1026	CP1-10B-20	3/91
1SFA619100R1041	CP1-10R-01	3/91
1SFA619100R1046	CP1-10B-01	3/91
1SFA619100R1051	CP1-10R-02	3/91
1SFA619100R1056	CP1-10B-02	3/91
1SFA619100R1071	CP1-10R-11	3/91
1SFA619100R1072	CP1-10G-11	3/91
1SFA619100R1073	CP1-10Y-11	3/91
1SFA619100R1074	CP1-10L-11	3/91
1SFA619100R1075	CP1-10W-11	3/91
1SFA619100R1076	CP1-10B-11	3/91
1SFA619100R1111	CP1-11R-10	3/95
1SFA619100R1112	CP1-11G-10	3/95
1SFA619100R1113	CP1-11Y-10	3/95
1SFA619100R1114	CP1-11L-10	3/95
1SFA619100R1118	CP1-11C-10	3/95
1SFA619100R1141	CP1-11R-01	3/95
1SFA619100R1211	CP1-12R-10	3/95
1SFA619100R1212	CP1-12G-10	3/95
1SFA619100R1213	CP1-12Y-10	3/95
1SFA619100R1214	CP1-12L-10	3/95
1SFA619100R1218	CP1-12C-10	3/95
1SFA619100R1241	CP1-12R-01	3/95
1SFA619100R1311	CP1-13R-10	3/95
1SFA619100R1312	CP1-13G-10	3/95
1SFA619100R1313	CP1-13Y-10	3/95
1SFA619100R1314	CP1-13L-10	3/95
1SFA619100R1318	CP1-13C-10	3/95
1SFA619100R1341	CP1-13R-01	3/95
1SFA619100R3011	CP1-30R-10	3/91
1SFA619100R3012	CP1-30G-10	3/91
1SFA619100R3013	CP1-30Y-10	3/91
1SFA619100R3014	CP1-30L-10	3/91
1SFA619100R3015	CP1-30W-10	3/91
1SFA619100R3016	CP1-30B-10	3/91
1SFA619100R3021	CP1-30R-20	3/91
1SFA619100R3022	CP1-30G-20	3/91
1SFA619100R3023	CP1-30Y-20	3/91
1SFA619100R3024	CP1-30L-20	3/91
1SFA619100R3025	CP1-30W-20	3/91
1SFA619100R3026	CP1-30B-20	3/91
1SFA619100R3041	CP1-30R-01	3/91
1SFA619100R3046	CP1-30B-01	3/91
1SFA619100R3051	CP1-30R-02	3/91
1SFA619100R3056	CP1-30B-02	3/91
1SFA619100R3071	CP1-30R-11	3/91
1SFA619100R3072	CP1-30G-11	3/91
1SFA619100R3073	CP1-30Y-11	3/91
1SFA619100R3074	CP1-30L-11	3/91
1SFA619100R3075	CP1-30W-11	3/91
1SFA619100R3076	CP1-30B-11	3/91
1SFA619100R3111	CP1-31R-10	3/95
1SFA619100R3112	CP1-31G-10	3/95
1SFA619100R3113	CP1-31Y-10	3/95
1SFA619100R3114	CP1-31L-10	3/95
1SFA619100R3118	CP1-31C-10	3/95
1SFA619100R3141	CP1-31R-01	3/95

Order code	Type	Page
1SFA619100R3144	CP1-31L-01	3/95
1SFA619101R1011	CP2-10R-10	3/92
1SFA619101R1012	CP2-10G-10	3/92
1SFA619101R1013	CP2-10Y-10	3/92
1SFA619101R1014	CP2-10L-10	3/92
1SFA619101R1015	CP2-10W-10	3/92
1SFA619101R1016	CP2-10B-10	3/92
1SFA619101R1021	CP2-10R-20	3/92
1SFA619101R1022	CP2-10G-20	3/92
1SFA619101R1023	CP2-10Y-20	3/92
1SFA619101R1024	CP2-10L-20	3/92
1SFA619101R1025	CP2-10W-20	3/92
1SFA619101R1026	CP2-10B-20	3/92
1SFA619101R1041	CP2-10R-01	3/92
1SFA619101R1046	CP2-10B-01	3/92
1SFA619101R1051	CP2-10R-02	3/92
1SFA619101R1056	CP2-10B-02	3/92
1SFA619101R1071	CP2-10R-11	3/92
1SFA619101R1072	CP2-10G-11	3/92
1SFA619101R1073	CP2-10Y-11	3/92
1SFA619101R1074	CP2-10L-11	3/92
1SFA619101R1075	CP2-10W-11	3/92
1SFA619101R1076	CP2-10B-11	3/92
1SFA619101R1111	CP2-11R-10	3/96
1SFA619101R1112	CP2-11G-10	3/96
1SFA619101R1113	CP2-11Y-10	3/96
1SFA619101R1114	CP2-11L-10	3/96
1SFA619101R1118	CP2-11C-10	3/96
1SFA619101R1141	CP2-11R-01	3/96
1SFA619101R1211	CP2-12R-10	3/96
1SFA619101R1212	CP2-12G-10	3/96
1SFA619101R1213	CP2-12Y-10	3/96
1SFA619101R1214	CP2-12L-10	3/96
1SFA619101R1218	CP2-12C-10	3/96
1SFA619101R1241	CP2-12R-01	3/96
1SFA619101R1311	CP2-13R-10	3/96
1SFA619101R1312	CP2-13G-10	3/96
1SFA619101R1313	CP2-13Y-10	3/96
1SFA619101R1314	CP2-13L-10	3/96
1SFA619101R1318	CP2-13C-10	3/96
1SFA619101R1341	CP2-13R-01	3/96
1SFA619101R3011	CP2-30R-10	3/92
1SFA619101R3012	CP2-30G-10	3/92
1SFA619101R3014	CP2-30L-10	3/92
1SFA619101R3015	CP2-30W-10	3/92
1SFA619101R3016	CP2-30B-10	3/92
1SFA619101R3021	CP2-30R-20	3/92
1SFA619101R3022	CP2-30G-20	3/92
1SFA619101R3023	CP2-30Y-20	3/92
1SFA619101R3024	CP2-30L-20	3/92
1SFA619101R3025	CP2-30W-20	3/92
1SFA619101R3026	CP2-30B-20	3/92
1SFA619101R3041	CP2-30R-01	3/92
1SFA619101R3046	CP2-30B-01	3/92
1SFA619101R3051	CP2-30R-02	3/92
1SFA619101R3071	CP2-30R-11	3/92
1SFA619101R3072	CP2-30G-11	3/92
1SFA619101R3073	CP2-30Y-11	3/92
1SFA619101R3076	CP2-30B-11	3/92
1SFA619102R1011	CP3-10R-10	3/93
1SFA619102R1012	CP3-10G-10	3/93
1SFA619102R1013	CP3-10Y-10	3/93
1SFA619102R1014	CP3-10L-10	3/93
1SFA619102R1015	CP3-10W-10	3/93
1SFA619102R1016	CP3-10B-10	3/93
1SFA619102R1021	CP3-10R-20	3/93
1SFA619102R1022	CP3-10G-20	3/93
1SFA619102R1023	CP3-10Y-20	3/93
1SFA619102R1024	CP3-10L-20	3/93
1SFA619102R1025	CP3-10W-20	3/93
1SFA619102R1026	CP3-10B-20	3/93
1SFA619102R1041	CP3-10R-01	3/93
1SFA619102R1046	CP3-10B-01	3/93
1SFA619102R1051	CP3-10R-02	3/93
1SFA619102R1056	CP3-10B-02	3/93
1SFA619102R1071	CP3-10R-11	3/93
1SFA619102R1072	CP3-10G-11	3/93
1SFA619102R1073	CP3-10Y-11	3/93
1SFA619102R1074	CP3-10L-11	3/93
1SFA619102R1075	CP3-10W-11	3/93
1SFA619102R1076	CP3-10B-11	3/93
1SFA619102R1111	CP3-11R-10	3/97
1SFA619102R1112	CP3-11G-10	3/97
1SFA619102R1113	CP3-11Y-10	3/97

Order code	Type	Page
1SFA619102R1114	CP3-11L-10	3/97
1SFA619102R1118	CP3-11C-10	3/97
1SFA619102R1141	CP3-11R-01	3/97
1SFA619102R1211	CP3-12R-10	3/97
1SFA619102R1212	CP3-12G-10	3/97
1SFA619102R1213	CP3-12Y-10	3/97
1SFA619102R1214	CP3-12L-10	3/97
1SFA619102R1218	CP3-12C-10	3/97
1SFA619102R1241	CP3-12R-01	3/97
1SFA619102R1311	CP3-13R-10	3/97
1SFA619102R1312	CP3-13G-10	3/97
1SFA619102R1313	CP3-13Y-10	3/97
1SFA619102R1314	CP3-13L-10	3/97
1SFA619102R1318	CP3-13C-10	3/97
1SFA619102R1341	CP3-13R-01	3/97
1SFA619102R3012	CP3-30G-10	3/93
1SFA619102R3015	CP3-30W-10	3/93
1SFA619102R3016	CP3-30B-10	3/93
1SFA619102R3021	CP3-30R-20	3/93
1SFA619102R3022	CP3-30G-20	3/93
1SFA619102R3023	CP3-30Y-20	3/93
1SFA619102R3024	CP3-30L-20	3/93
1SFA619102R3025	CP3-30W-20	3/93
1SFA619102R3026	CP3-30B-20	3/93
1SFA619102R3041	CP3-30R-01	3/93
1SFA619102R3046	CP3-30B-01	3/93
1SFA619102R3071	CP3-30R-11	3/93
1SFA619102R3072	CP3-30G-11	3/93
1SFA619102R3076	CP3-30B-11	3/93
1SFA619103R1011	CP4-10R-10	3/94
1SFA619103R1012	CP4-10G-10	3/94
1SFA619103R1013	CP4-10Y-10	3/94
1SFA619103R1014	CP4-10L-10	3/94
1SFA619103R1015	CP4-10W-10	3/94
1SFA619103R1016	CP4-10B-10	3/94
1SFA619103R1021	CP4-10R-20	3/94
1SFA619103R1022	CP4-10G-20	3/94
1SFA619103R1026	CP4-10B-20	3/94
1SFA619103R1041	CP4-10R-01	3/94
1SFA619103R1051	CP4-10R-02	3/94
1SFA619103R1056	CP4-10B-02	3/94
1SFA619103R1071	CP4-10R-11	3/94
1SFA619103R1072	CP4-10G-11	3/94
1SFA619103R1073	CP4-10Y-11	3/94
1SFA619103R1074	CP4-10L-11	3/94
1SFA619103R1075	CP4-10W-11	3/94
1SFA619103R1076	CP4-10B-11	3/94
1SFA619103R1111	CP4-11R-10	3/98
1SFA619103R1112	CP4-11G-10	3/98
1SFA619103R1113	CP4-11Y-10	3/98
1SFA619103R1114	CP4-11L-10	3/98
1SFA619103R1118	CP4-11C-10	3/98
1SFA619103R1141	CP4-11R-01	3/98
1SFA619103R1211	CP4-12R-10	3/98
1SFA619103R1212	CP4-12G-10	3/98
1SFA619103R1213	CP4-12Y-10	3/98
1SFA619103R1214	CP4-12L-10	3/98
1SFA619103R1218	CP4-12C-10	3/98
1SFA619103R1241	CP4-12R-01	3/98
1SFA619103R1311	CP4-13R-10	3/98
1SFA619103R1312	CP4-13G-10	3/98
1SFA619103R1313	CP4-13Y-10	3/98
1SFA619103R1314	CP4-13L-10	3/98
1SFA619103R1318	CP4-13C-10	3/98
1SFA619103R1341	CP4-13R-01	3/98
1SFA619103R3012	CP4-30G-10	3/94
1SFA619103R3022	CP4-30G-20	3/94
1SFA619103R3071	CP4-30R-11	3/94
1SFA619105R1021	CP6-10R-20	3/102
1SFA619105R1022	CP6-10G-20	3/102
1SFA619105R1026	CP6-10B-20	3/102
1SFA619105R1051	CP6-10R-02	3/102
1SFA619105R1056	CP6-10B-02	3/102
1SFA619105R1071	CP6-10R-11	3/102
1SFA619105R1072	CP6-10G-11	3/102
1SFA619105R1076	CP6-10B-11	3/102
1SFA619126R1071	CPM3-10R-11	3/99
1SFA619126R1072	CPM3-10G-11	3/99
1SFA619126R1073	CPM3-10Y-11	3/99
1SFA619126R1074	CPM3-10L-11	3/99
1SFA619126R1076	CPM3-10B-11	3/99
1SFA619200R1016	C2SS1-10B-10	3/107
1SFA619200R1026	C2SS1-10B-20	3/107

Index

Order code classification

Order code	Type	Page	Order code	Type	Page	Order code	Type	Page
1SFA619200R1046	C2SS1-10B-01	3/107	1SFA619403R5231	CL2-523R	3/104	1SFA619930R1027	CA6-1027	4/128
1SFA619200R1076	C2SS1-10B-11	3/107	1SFA619403R5232	CL2-523G	3/104	SK615502-D	-	2/47
1SFA619200R3016	C2SS1-30B-10	3/107	1SFA619403R5233	CL2-523Y	3/104	SK615502-D	-	3/110
1SFA619200R3026	C2SS1-30B-20	3/107	1SFA619403R5234	CL2-523L	3/104	SK615512-1	-	2/47
1SFA619200R3046	C2SS1-30B-01	3/107	1SFA619403R5238	CL2-523C	3/104	SK615512-1	-	3/110
1SFA619200R3076	C2SS1-30B-11	3/107	1SFA619403R5421	CL2-542R	3/104	SK615516-1	-	4/124
1SFA619201R1016	C2SS2-10B-10	3/107	1SFA619403R5422	CL2-542G	3/104	SK615546-1	-	5/136
1SFA619201R1026	C2SS2-10B-20	3/107	1SFA619403R5423	CL2-542Y	3/104	SK615546-13	-	5/136
1SFA619201R1046	C2SS2-10B-01	3/107	1SFA619403R5424	CL2-542L	3/104	SK615546-15	-	5/136
1SFA619201R1076	C2SS2-10B-11	3/107	1SFA619403R5428	CL2-542C	3/104	SK615546-2	-	5/136
1SFA619201R3016	C2SS2-30B-10	3/107	1SFA619403R6231	CL2-623R	3/104	SK615546-3	-	5/136
1SFA619201R3026	C2SS2-30B-20	3/107	1SFA619403R6232	CL2-623G	3/104	SK615546-4	-	5/136
1SFA619201R3046	C2SS2-30B-01	3/107	1SFA619403R6233	CL2-623Y	3/104	SK615546-5	-	5/136
1SFA619201R3076	C2SS2-30B-11	3/107	1SFA619403R6234	CL2-623L	3/104	SK615546-6	-	5/136
1SFA619202R1016	C2SS3-10B-10	3/107	1SFA619403R6238	CL2-623C	3/104	SK615546-8	-	5/136
1SFA619202R1026	C2SS3-10B-20	3/107	1SFA619500R1041	CE3T-10R-01	3/100	SK615550-29	-	5/137
1SFA619202R1046	C2SS3-10B-01	3/107	1SFA619500R1046	CE3T-10B-01	3/101	SK615550-44	-	5/137
1SFA619202R1076	C2SS3-10B-11	3/107	1SFA619500R1051	CE3T-10R-02	3/100	SK615550-61	-	5/137
1SFA619202R3016	C2SS3-30B-10	3/107	1SFA619500R1071	CE3T-10R-11	3/100	SK615550-62	-	5/137
1SFA619202R3026	C2SS3-30B-20	3/107	1SFA619500R1076	CE3T-10B-11	3/101	SK615550-80	-	5/137
1SFA619202R3076	C2SS3-30B-11	3/107	1SFA619501R1041	CE3P-10R-01	3/100	SK615550-81	-	5/137
1SFA619204R3016	C2SS5-30B-10	3/107	1SFA619501R1051	CE3P-10R-02	3/100	SK615552-13	-	5/137
1SFA619204R3076	C2SS5-30B-11	3/107	1SFA619501R1071	CE3P-10R-11	3/100	SK615552-14	-	5/137
1SFA619210R1026	C3SS1-10B-20	3/108	1SFA619501R1076	CE3P-10B-11	3/101	SK615552-15	-	5/137
1SFA619210R1076	C3SS1-10B-11	3/108	1SFA619502R1041	CE3K1-10R-01	3/100	SK615552-16	-	5/137
1SFA619210R3026	C3SS1-30B-20	3/108	1SFA619502R1051	CE3K1-10R-02	3/100	SK615552-17	-	5/137
1SFA619210R3076	C3SS1-30B-11	3/108	1SFA619502R1071	CE3K1-10R-11	3/100	SK615552-21	-	5/137
1SFA619211R1026	C3SS2-10B-20	3/108	1SFA619502R1076	CE3K1-10B-11	3/101	SK615552-22	-	5/137
1SFA619211R1076	C3SS2-10B-11	3/108	1SFA619550R1016	CE4T-10B-10	3/101	SK615552-23	-	5/137
1SFA619211R3026	C3SS2-30B-20	3/108	1SFA619550R1026	CE4T-10B-20	3/101	SK615552-25	-	5/137
1SFA619211R3076	C3SS2-30B-11	3/108	1SFA619550R1041	CE4T-10R-01	3/100	SK615552-27	-	5/137
1SFA619212R1026	C3SS3-10B-20	3/108	1SFA619550R1046	CE4T-10B-01	3/101	SK615552-28	-	5/137
1SFA619212R1076	C3SS3-10B-11	3/108	1SFA619550R1051	CE4T-10R-02	3/100	SK615552-29	-	5/137
1SFA619212R3026	C3SS3-30B-20	3/108	1SFA619550R1056	CE4T-10B-02	3/101	SK615552-30	-	5/137
1SFA619212R3076	C3SS3-30B-11	3/108	1SFA619550R1071	CE4T-10R-11	3/100	SK615552-31	-	5/137
1SFA619213R1026	C3SS4-10B-20	3/108	1SFA619550R1076	CE4T-10B-11	3/101	SK615552-32	-	5/137
1SFA619213R1076	C3SS4-10B-11	3/108	1SFA619551R1041	CE4P-10R-01	3/100	SK615562-12	-	5/137
1SFA619214R1026	C3SS5-10B-20	3/108	1SFA619551R1051	CE4P-10R-02	3/100	SK615562-82	-	5/137
1SFA619214R1076	C3SS5-10B-11	3/108	1SFA619551R1071	CE4P-10R-11	3/100	SK615562-87	-	2/38
1SFA619214R3026	C3SS5-30B-20	3/108	1SFA619551R1076	CE4P-10B-11	3/101	SK615562-88	-	2/38
1SFA619216R1026	C3SS7-10B-20	3/108	1SFA619552R1041	CE4K1-10R-01	3/100	SK616016-2	-	2/47
1SFA619216R1076	C3SS7-10B-11	3/108	1SFA619552R1051	CE4K1-10R-02	3/100	SK616016-2	-	3/110
1SFA619216R3026	C3SS7-30B-20	3/108	1SFA619552R1071	CE4K1-10R-11	3/100			
1SFA619402R1001	CL-100R	3/105	1SFA619552R1076	CE4K1-10B-11	3/101			
1SFA619402R1002	CL-100G	3/105	1SFA619600R6002	CB1-600G	3/109			
1SFA619402R1003	CL-100Y	3/105	1SFA619600R6012	CB1-601G	3/109			
1SFA619402R1004	CL-100L	3/105	1SFA619600R6022	CB1-602G	3/109			
1SFA619402R1005	CL-100W	3/105	1SFA619600R6032	CB1-603G	3/109			
1SFA619402R1008	CL-100C	3/105	1SFA619600R6101	CB1-610R	3/109			
1SFA619403R5011	CL2-501R	3/103	1SFA619600R6103	CB1-610Y	3/109			
1SFA619403R5012	CL2-501G	3/103	1SFA619600R6111	CB1-611R	3/109			
1SFA619403R5013	CL2-501Y	3/103	1SFA619600R6113	CB1-611Y	3/109			
1SFA619403R5014	CL2-501L	3/103	1SFA619600R6121	CB1-612R	3/109			
1SFA619403R5018	CL2-501C	3/103	1SFA619600R6123	CB1-612Y	3/109			
1SFA619403R5021	CL2-502R	3/103	1SFA619600R6131	CB1-613R	3/109			
1SFA619403R5022	CL2-502G	3/103	1SFA619600R6133	CB1-613Y	3/109			
1SFA619403R5023	CL2-502Y	3/103	1SFA619600R6206	CB1-620B	3/109			
1SFA619403R5024	CL2-502L	3/103	1SFA619600R6216	CB1-621B	3/109			
1SFA619403R5028	CL2-502C	3/103	1SFA619600R6226	CB1-622B	3/109			
1SFA619403R5061	CL2-506R	3/103	1SFA619600R6236	CB1-623B	3/109			
1SFA619403R5062	CL2-506G	3/103	1SFA619600R6306	CB1-630B	3/109			
1SFA619403R5063	CL2-506Y	3/103	1SFA619600R6316	CB1-631B	3/109			
1SFA619403R5064	CL2-506L	3/103	1SFA619600R6326	CB1-632B	3/109			
1SFA619403R5068	CL2-506C	3/103	1SFA619600R6336	CB1-633B	3/109			
1SFA619403R5071	CL2-507R	3/103	1SFA619811R1000	CEP1-0	4/123			
1SFA619403R5072	CL2-507G	3/103	1SFA619811R1001	CEP1-1001	4/130			
1SFA619403R5073	CL2-507Y	3/103	1SFA619811R1002	CEP1-1002	4/130			
1SFA619403R5074	CL2-507L	3/103	1SFA619811R2001	CEP1-2001	4/130			
1SFA619403R5078	CL2-507C	3/103	1SFA619811R2002	CEP1-2002	4/130			
1SFA619403R5131	CL2-513R	3/103	1SFA619821R1000	CEPY1-0	4/123			
1SFA619403R5132	CL2-513G	3/103	1SFA619821R1001	CEPY1-1001	4/130			
1SFA619403R5133	CL2-513Y	3/103	1SFA619821R1002	CEPY1-1002	4/130			
1SFA619403R5134	CL2-513L	3/103	1SFA619821R1006	CEPY1-1006	4/130			
1SFA619403R5138	CL2-513C	3/103	1SFA619821R2001	CEPY1-2001	4/130			
1SFA619403R5151	CL2-515R	3/103	1SFA619821R2002	CEPY1-2002	4/130			
1SFA619403R5152	CL2-515G	3/103	1SFA619920R8053	CA1-8053	3/110			
1SFA619403R5153	CL2-515Y	3/103	1SFA619920R8054	CA1-8054	4/123			
1SFA619403R5154	CL2-515L	3/103	1SFA619920R8054	CA1-8054	3/110			
1SFA619403R5158	CL2-515C	3/103	1SFA619920R8054	CA1-8054	4/123			
1SFA619403R5201	CL2-520R	3/104	1SFA619920R8077	CA1-8077	3/110			
1SFA619403R5202	CL2-520G	3/104	1SFA619920R8078	CA1-8078	3/110			
1SFA619403R5203	CL2-520Y	3/104	1SFA619920R8080	CA1-8080	3/111			
1SFA619403R5204	CL2-520L	3/104	1SFA619930R1024	CA6-1024	4/128			
1SFA619403R5208	CL2-520C	3/104	1SFA619930R1026	CA6-1026	4/128			

Index

Type classification

Type	Order code	Page	Type	Order code	Page	Type	Order code	Page
-	SK615502-D	2/47	BA9S110LEDR	1SFA187183R1041	3/78	CB1-600G	1SFA619600R6002	3/109
-	SK615502-D	3/110	BA9S110LEDV	1SFA187184R1042	3/78	CB1-601G	1SFA619600R6012	3/109
-	SK615512-1	2/47	BA9S12LEDB	1SFA187165R1015	3/78	CB1-602G	1SFA619600R6022	3/109
-	SK615512-1	3/110	BA9S12LEDG	1SFA187166R1013	3/78	CB1-603G	1SFA619600R6032	3/109
-	SK615516-1	4/124	BA9S12LEDL	1SFA187167R1014	3/78	CB1-610R	1SFA619600R6101	3/109
-	SK615546-1	5/136	BA9S12LEDR	1SFA187168R1011	3/78	CB1-610Y	1SFA619600R6103	3/109
-	SK615546-13	5/136	BA9S12LEDV	1SFA187169R1012	3/78	CB1-611R	1SFA619600R6111	3/109
-	SK615546-15	5/136	BA9S130LED	1SFA187190R1045	3/78	CB1-611Y	1SFA619600R6113	3/109
-	SK615546-2	5/136	BA9S230LEDB	1SFA187185R1055	3/78	CB1-612R	1SFA619600R6121	3/109
-	SK615546-3	5/136	BA9S230LEDG	1SFA187186R1053	3/78	CB1-612Y	1SFA619600R6123	3/109
-	SK615546-4	5/136	BA9S230LEDL	1SFA187187R1054	3/78	CB1-613R	1SFA619600R6131	3/109
-	SK615546-5	5/136	BA9S230LEDR	1SFA187188R1051	3/78	CB1-613Y	1SFA619600R6133	3/109
-	SK615546-6	5/136	BA9S230LEDV	1SFA187189R1052	3/78	CB1-620B	1SFA619600R6206	3/109
-	SK615546-8	5/136	BA9S24LEDB	1SFA187170R1025	3/78	CB1-621B	1SFA619600R6216	3/109
-	SK615550-29	5/137	BA9S24LEDG	1SFA187171R1023	3/78	CB1-622B	1SFA619600R6226	3/109
-	SK615550-44	5/137	BA9S24LEDL	1SFA187172R1024	3/78	CB1-623B	1SFA619600R6236	3/109
-	SK615550-61	5/137	BA9S24LEDR	1SFA187173R1021	3/78	CB1-630B	1SFA619600R6306	3/109
-	SK615550-62	5/137	BA9S24LEDV	1SFA187174R1022	3/78	CB1-631B	1SFA619600R6316	3/109
-	SK615550-80	5/137	BA9S48LEDB	1SFA187175R1035	3/78	CB1-632B	1SFA619600R6326	3/109
-	SK615550-81	5/137	BA9S48LEDG	1SFA187176R1033	3/78	CB1-633B	1SFA619600R6336	3/109
-	SK615552-13	5/137	BA9S48LEDL	1SFA187177R1034	3/78	CE3K1-10B-11	1SFA619502R1076	3/101
-	SK615552-14	5/137	BA9S48LEDR	1SFA187178R1031	3/78	CE3K1-10R-01	1SFA619502R1041	3/100
-	SK615552-15	5/137	BA9S48LEDV	1SFA187179R1032	3/78	CE3K1-10R-02	1SFA619502R1051	3/100
-	SK615552-16	5/137	BA9S60LED	1SFA187191R1045	3/78	CE3K1-10R-11	1SFA619502R1071	3/100
-	SK615552-17	5/137	BA9S6LEDB	1SFA187160R1005	3/78	CE3P-10B-11	1SFA619501R1076	3/101
-	SK615552-21	5/137	BA9S6LEDG	1SFA187161R1003	3/78	CE3P-10R-01	1SFA619501R1041	3/100
-	SK615552-22	5/137	BA9S6LEDL	1SFA187162R1004	3/78	CE3P-10R-02	1SFA619501R1051	3/100
-	SK615552-23	5/137	BA9S6LEDR	1SFA187163R1001	3/78	CE3P-10R-11	1SFA619501R1071	3/100
-	SK615552-25	5/137	BA9S6LEDV	1SFA187164R1002	3/78	CE3T-10B-01	1SFA619500R1046	3/101
-	SK615552-27	5/137	C2SS1-10B-01	1SFA619200R1046	3/107	CE3T-10B-11	1SFA619500R1076	3/101
-	SK615552-28	5/137	C2SS1-10B-10	1SFA619200R1016	3/107	CE3T-10R-01	1SFA619500R1041	3/100
-	SK615552-29	5/137	C2SS1-10B-11	1SFA619200R1076	3/107	CE3T-10R-02	1SFA619500R1051	3/100
-	SK615552-30	5/137	C2SS1-10B-20	1SFA619200R1026	3/107	CE3T-10R-11	1SFA619500R1071	3/100
-	SK615552-31	5/137	C2SS1-30B-01	1SFA619200R3046	3/107	CE4K1-10B-11	1SFA619552R1076	3/101
-	SK615552-32	5/137	C2SS1-30B-10	1SFA619200R3016	3/107	CE4K1-10R-01	1SFA619552R1041	3/100
-	SK615562-12	5/137	C2SS1-30B-11	1SFA619200R3076	3/107	CE4K1-10R-02	1SFA619552R1051	3/100
-	SK615562-82	5/137	C2SS1-30B-20	1SFA619200R3026	3/107	CE4K1-10R-11	1SFA619552R1071	3/100
-	SK615562-87	2/38	C2SS2-10B-01	1SFA619201R1046	3/107	CE4P-10B-11	1SFA619551R1076	3/101
-	SK615562-88	2/38	C2SS2-10B-10	1SFA619201R1016	3/107	CE4P-10R-01	1SFA619551R1041	3/100
-	SK616016-2	2/47	C2SS2-10B-11	1SFA619201R1076	3/107	CE4P-10R-02	1SFA619551R1051	3/100
-	SK616016-2	3/110	C2SS2-10B-20	1SFA619201R1026	3/107	CE4P-10R-11	1SFA619551R1071	3/100
080CPN	1SFA170190R8000	3/80	C2SS2-30B-01	1SFA619201R3046	3/107	CE4T-10B-01	1SFA619550R1046	3/101
080CPR	1SFA170191R8000	3/80	C2SS2-30B-10	1SFA619201R3016	3/107	CE4T-10B-02	1SFA619550R1056	3/101
080CPT	1SFA170198R8000	3/80	C2SS2-30B-11	1SFA619201R3076	3/107	CE4T-10B-10	1SFA619550R1016	3/101
080CPV	1SFA170192R8000	3/80	C2SS2-30B-20	1SFA619201R3026	3/107	CE4T-10B-11	1SFA619550R1076	3/101
080SP1	1SFA170801R1001	3/81	C2SS3-10B-01	1SFA619202R1046	3/107	CE4T-10B-20	1SFA619550R1026	3/101
080SP12	1SFA170808R1012	3/81	C2SS3-10B-10	1SFA619202R1016	3/107	CE4T-10R-01	1SFA619550R1041	3/100
080SP12SF	1SFA170858R4000	3/82	C2SS3-10B-11	1SFA619202R1076	3/107	CE4T-10R-02	1SFA619550R1051	3/100
080SP12SFC	1SFA170856R2000	3/82	C2SS3-10B-20	1SFA619202R1026	3/107	CE4T-10R-11	1SFA619550R1071	3/100
080SP12SFE	1SFA170857R3012	3/81	C2SS3-30B-10	1SFA619202R3016	3/107	CEP1-0	1SFA619811R1000	4/123
080SP18	1SFA170809R1018	3/81	C2SS3-30B-11	1SFA619202R3076	3/107	CEP1-1001	1SFA619811R1001	4/130
080SP18SF	1SFA170861R4000	3/82	C2SS3-30B-20	1SFA619202R3026	3/107	CEP1-1002	1SFA619811R1002	4/130
080SP18SFC	1SFA170859R2000	3/82	C2SS5-30B-10	1SFA619204R3016	3/107	CEP1-2001	1SFA619811R2001	4/130
080SP1M	1SFA170831R1001	3/81	C2SS5-30B-11	1SFA619204R3076	3/107	CEP1-2002	1SFA619811R2002	4/130
080SP1MSF	1SFA170840R4000	3/82	C3SS1-10B-11	1SFA619210R1076	3/108	CEPY1-0	1SFA619821R1000	4/123
080SP1MSFC	1SFA170838R2000	3/82	C3SS1-10B-20	1SFA619210R1026	3/108	CEPY1-1001	1SFA619821R1001	4/130
080SP1MSFE	1SFA170839R3001	3/81	C3SS1-30B-11	1SFA619210R3076	3/108	CEPY1-1002	1SFA619821R1002	4/130
080SP1SF	1SFA170837R4000	3/82	C3SS1-30B-20	1SFA619210R3026	3/108	CEPY1-1006	1SFA619821R1006	4/130
080SP1SFC	1SFA170835R2000	3/82	C3SS2-10B-11	1SFA619211R1076	3/108	CEPY1-2001	1SFA619821R2001	4/130
080SP1SFE	1SFA170836R3001	3/81	C3SS2-10B-20	1SFA619211R1026	3/108	CEPY1-2002	1SFA619821R2002	4/130
080SP2	1SFA170802R1002	3/81	C3SS2-30B-11	1SFA619211R3076	3/108	CL-100C	1SFA619402R1008	3/105
080SP24	1SFA170810R1024	3/81	C3SS2-30B-20	1SFA619211R3026	3/108	CL-100G	1SFA619402R1002	3/105
080SP2M	1SFA170832R1002	3/81	C3SS3-10B-11	1SFA619212R1076	3/108	CL-100L	1SFA619402R1004	3/105
080SP2MSF	1SFA170846R4000	3/82	C3SS3-10B-20	1SFA619212R1026	3/108	CL-100R	1SFA619402R1001	3/105
080SP2MSFC	1SFA170844R2000	3/82	C3SS3-30B-11	1SFA619212R3076	3/108	CL-100W	1SFA619402R1005	3/105
080SP2SF	1SFA170843R4000	3/82	C3SS3-30B-20	1SFA619212R3026	3/108	CL-100Y	1SFA619402R1003	3/105
080SP2SFC	1SFA170841R2000	3/82	C3SS4-10B-11	1SFA619213R1076	3/108	CL2-501C	1SFA619403R5018	3/103
080SP2SFE	1SFA170842R3002	3/81	C3SS4-10B-20	1SFA619213R1026	3/108	CL2-501G	1SFA619403R5012	3/103
080SP3	1SFA170803R1003	3/81	C3SS5-10B-11	1SFA619214R1076	3/108	CL2-501L	1SFA619403R5014	3/103
080SP3SF	1SFA170849R4000	3/82	C3SS5-10B-20	1SFA619214R1026	3/108	CL2-501R	1SFA619403R5011	3/103
080SP3SFC	1SFA170847R2000	3/82	C3SS5-30B-20	1SFA619214R3026	3/108	CL2-501Y	1SFA619403R5013	3/103
080SP3SFE	1SFA170848R3003	3/81	C3SS7-10B-11	1SFA619216R1076	3/108	CL2-502C	1SFA619403R5028	3/103
080SP4	1SFA170804R1004	3/81	C3SS7-10B-20	1SFA619216R1026	3/108	CL2-502G	1SFA619403R5022	3/103
080SP4M	1SFA170834R1004	3/81	C3SS7-30B-20	1SFA619216R3026	3/108	CL2-502L	1SFA619403R5024	3/103
080SP4SFE	1SFA170850R3004	3/81	CA1-8053	1SFA619920R8053	3/110	CL2-502R	1SFA619403R5021	3/103
080SP6	1SFA170806R1006	3/81	CA1-8053	1SFA619920R8053	4/123	CL2-502Y	1SFA619403R5023	3/103
080SP6SFE	1SFA170852R3006	3/81	CA1-8054	1SFA619920R8054	3/110	CL2-506C	1SFA619403R5068	3/103
080SP8	1SFA170807R1008	3/81	CA1-8054	1SFA619920R8054	4/123	CL2-506G	1SFA619403R5062	3/103
080SP8SF	1SFA170855R4000	3/82	CA1-8077	1SFA619920R8077	3/110	CL2-506L	1SFA619403R5064	3/103
080SP8SFC	1SFA170853R2000	3/82	CA1-8078	1SFA619920R8078	3/110	CL2-506R	1SFA619403R5061	3/103
080SP8SFE	1SFA170854R3008	3/81	CA1-8080	1SFA619920R8080	3/111	CL2-506Y	1SFA619403R5063	3/103
BA9S110LEDB	1SFA187180R1045	3/78	CA6-1024	1SFA619930R1024	4/128	CL2-507C	1SFA619403R5078	3/103
BA9S110LEDG	1SFA187181R1043	3/78	CA6-1026	1SFA619930R1026	4/128	CL2-507G	1SFA619403R5072	3/103
BA9S110LEDL	1SFA187182R1044	3/78	CA6-1027	1SFA619930R1027	4/128	CL2-507L	1SFA619403R5074	3/103

Index

Type classification

Type	Order code	Page
CP4-30R-11	1SFA619103R3071	3/94
CP6-10B-02	1SFA619105R1056	3/102
CP6-10B-11	1SFA619105R1076	3/102
CP6-10B-20	1SFA619105R1026	3/102
CP6-10G-11	1SFA619105R1072	3/102
CP6-10G-20	1SFA619105R1022	3/102
CP6-10R-02	1SFA619105R1051	3/102
CP6-10R-11	1SFA619105R1071	3/102
CP6-10R-20	1SFA619105R1021	3/102
CPM3-10B-11	1SFA619126R1076	3/99
CPM3-10G-11	1SFA619126R1072	3/99
CPM3-10L-11	1SFA619126R1074	3/99
CPM3-10R-11	1SFA619126R1071	3/99
CPM3-10Y-11	1SFA619126R1073	3/99
KA1-8005	1SFA616920R8005	2/25
KA1-8010	1SFA616920R8010	2/47
KA1-8010	1SFA616920R8010	3/110
KA1-8020	1SFA616920R8020	2/47
KA1-8020	1SFA616920R8020	3/110
KA1-8021	1SFA616920R8021	2/47
KA1-8021	1SFA616920R8021	3/110
KA1-8022	1SFA616920R8022	2/47
KA1-8022	1SFA616920R8022	3/110
KA1-8024	1SFA616920R8024	2/47
KA1-8027	1SFA616920R8027	2/47
KA1-8027	1SFA616920R8027	3/110
KA1-8028	1SFA616920R8028	2/47
KA1-8028	1SFA616920R8028	3/110
KA1-8029	1SFA616920R8029	2/47
KA1-8029	1SFA616920R8029	3/110
KA1-8045	1SFA616920R8045	4/124
KA1-8046	1SFA616920R8046	2/39
KA1-8047	1SFA616920R8047	2/39
KA1-8072	1SFA616920R8072	3/110
KA1-8073	1SFA616920R8073	2/47
KA1-8073	1SFA616920R8073	3/110
KA1-8080	1SFA616920R8080	2/47
KA1-8120	1SFA616920R8120	5/135
KA1-8121	1SFA616920R8121	5/135
KA2-2011	1SFA616921R2011	3/106
KA2-2012	1SFA616921R2012	3/106
KA2-2013	1SFA616921R2013	3/106
KA2-2014	1SFA616921R2014	3/106
KA2-2015	1SFA616921R2015	3/106
KA2-2021	1SFA616921R2021	3/106
KA2-2022	1SFA616921R2022	3/106
KA2-2023	1SFA616921R2023	3/106
KA2-2024	1SFA616921R2024	3/106
KA2-2025	1SFA616921R2025	3/106
KA2-2031	1SFA616921R2031	3/106
KA2-2032	1SFA616921R2032	3/106
KA2-2033	1SFA616921R2033	3/106
KA2-2034	1SFA616921R2034	3/106
KA2-2035	1SFA616921R2035	3/106
KA2-2041	1SFA616921R2041	3/106
KA2-2042	1SFA616921R2042	3/106
KA2-2043	1SFA616921R2043	3/106
KA2-2044	1SFA616921R2044	3/106
KA2-2045	1SFA616921R2045	3/106
KA2-2051	1SFA616921R2051	3/106
KA2-2052	1SFA616921R2052	3/106
KA2-2053	1SFA616921R2053	3/106
KA2-2054	1SFA616921R2054	3/106
KA2-2055	1SFA616921R2055	3/106
KA2-2131	1SFA616921R2131	3/106
KA2-2132	1SFA616921R2132	3/106
KA2-2133	1SFA616921R2133	3/106
KA2-2134	1SFA616921R2134	3/106
KA2-2135	1SFA616921R2135	3/106
KA2-2141	1SFA616921R2141	3/106
KA2-2142	1SFA616921R2142	3/106
KA2-2143	1SFA616921R2143	3/106
KA2-2144	1SFA616921R2144	3/106
KA2-2145	1SFA616921R2145	3/106
KA2-2221	1SFA616921R2221	3/106
KA2-2222	1SFA616921R2222	3/106
KA2-2223	1SFA616921R2223	3/106
KA2-2224	1SFA616921R2224	3/106
KA2-2225	1SFA616921R2225	3/106
KA2-2231	1SFA616921R2231	3/106
KA2-2232	1SFA616921R2232	3/106
KA2-2233	1SFA616921R2233	3/106
KA2-2234	1SFA616921R2234	3/106
KA2-2235	1SFA616921R2235	3/106

Type	Order code	Page
KA3-1018	1SFA616922R1018	6/146
KA3-1028	1SFA616922R1028	6/146
KA3-1118	1SFA616922R1118	6/146
KA3-1148	1SFA616922R1148	6/146
KA4-1021	1SFA616924R1021	6/144
KA4-1022	1SFA616924R1022	6/144
KA4-1023	1SFA616924R1023	6/144
KA4-1024	1SFA616924R1024	6/144
KA4-1025	1SFA616924R1025	6/144
KA4-1028	1SFA616923R1028	6/144
KA4-1118	1SFA616923R1118	6/144
KA4-1148	1SFA616923R1148	6/144
KA70-1001	1SFA616077R1001	6/145
KA70-1002	1SFA616077R1002	6/145
KA70-1011	1SFA616077R1011	6/145
KA70-1012	1SFA616077R1012	6/145
KA70-1013	1SFA616077R1013	6/145
KA70-1021	1SFA616077R1021	6/145
KA70-1022	1SFA616077R1022	6/145
KA70-1023	1SFA616077R1023	6/145
KA70-1031	1SFA616077R1031	6/145
KA70-1032	1SFA616077R1032	6/145
KA70-1033	1SFA616077R1033	6/145
KA70-1034	1SFA616077R1034	6/145
KASB-1000	1SFA616087R1000	6/146
KB70-1201	1SFA616071R1201	6/144
KB70-3001	1SFA616071R3001	6/144
KB70-3101	1SFA616071R3101	6/144
KL70-305C	1SFA616070R3058	6/143
KL70-305G	1SFA616070R3052	6/143
KL70-305L	1SFA616070R3054	6/143
KL70-305R	1SFA616070R3051	6/143
KL70-305Y	1SFA616070R3053	6/143
KL70-306C	1SFA616070R3068	6/143
KL70-306G	1SFA616070R3062	6/143
KL70-306L	1SFA616070R3064	6/143
KL70-306R	1SFA616070R3061	6/143
KL70-306Y	1SFA616070R3063	6/143
KL70-307C	1SFA616070R3078	6/143
KL70-307G	1SFA616070R3072	6/143
KL70-307L	1SFA616070R3074	6/143
KL70-307R	1SFA616070R3071	6/143
KL70-307Y	1SFA616070R3073	6/143
KL70-342C	1SFA616070R3428	6/143
KL70-342G	1SFA616070R3422	6/143
KL70-342L	1SFA616070R3424	6/143
KL70-342R	1SFA616070R3421	6/143
KL70-342Y	1SFA616070R3423	6/143
KL70-352C	1SFA616070R3528	6/143
KL70-352G	1SFA616070R3522	6/143
KL70-352L	1SFA616070R3524	6/143
KL70-352R	1SFA616070R3521	6/143
KL70-352Y	1SFA616070R3523	6/143
KL70-401C	1SFA616070R4018	6/143
KL70-401G	1SFA616070R4012	6/143
KL70-401L	1SFA616070R4014	6/143
KL70-401R	1SFA616070R4011	6/143
KL70-401Y	1SFA616070R4013	6/143
KP6-40B	1SFA616105R4006	2/25
KP6-40G	1SFA616105R4002	2/25
KP6-40R	1SFA616105R4001	2/25
KPR1-100B	1SFA616160R1006	2/39
KPR1-100G	1SFA616160R1002	2/39
KPR1-100L	1SFA616160R1004	2/39
KPR1-100R	1SFA616160R1001	2/39
KPR1-100W	1SFA616160R1005	2/39
KPR1-100Y	1SFA616160R1003	2/39
KPR1-101L	1SFA616160R1014	2/39
KPR1-101W	1SFA616160R1015	2/39
KPR1-102G	1SFA616160R1022	2/39
KPR1-102W	1SFA616160R1025	2/39
KPR1-103W	1SFA616160R1035	2/39
KPR1-104B	1SFA616160R1046	2/39
KPR2-100B	1SFA616161R1006	2/39
KPR2-100R	1SFA616161R1001	2/39
KPR2-105R	1SFA616161R1051	2/39
KPR3-100B	1SFA616162R1006	2/40
KPR3-100G	1SFA616162R1002	2/40
KPR3-100L	1SFA616162R1004	2/40
KPR3-100R	1SFA616162R1001	2/40
KPR3-100W	1SFA616162R1005	2/40
KPR3-100Y	1SFA616162R1003	2/40
KPR3-101L	1SFA616162R1014	2/40
KPR3-101W	1SFA616162R1015	2/40

Type	Order code	Page
KPR3-103G	1SFA616162R1032	2/40
KPR3-104B	1SFA616162R1046	2/40
KPR4-100B	1SFA616163R1006	2/40
KPR4-100R	1SFA616163R1001	2/40
KPR4-105B	1SFA616163R1056	2/40
KPR4-105R	1SFA616163R1051	2/40
KS70-1104	1SFA616073R1104	6/144
KS70-1204	1SFA616073R1204	6/144
KS70-2002	1SFA616073R2002	6/144
KS70-2004	1SFA616073R2004	6/144
KS70-3004	1SFA616073R3004	6/144
KSB-113C	1SFA616080R1138	6/146
KSB-113G	1SFA616080R1132	6/146
KSB-113L	1SFA616080R1134	6/146
KSB-113R	1SFA616080R1131	6/146
KSB-113Y	1SFA616080R1133	6/146
KSB-115G	1SFA616080R1152	6/146
KSB-115R	1SFA616080R1151	6/146
KSB-115Y	1SFA616080R1153	6/146
KSB-123C	1SFA616080R1238	6/146
KSB-123G	1SFA616080R1232	6/146
KSB-123L	1SFA616080R1234	6/146
KSB-123R	1SFA616080R1231	6/146
KSB-123Y	1SFA616080R1233	6/146
KSB-203C	1SFA616080R2038	6/146
KSB-203G	1SFA616080R2032	6/146
KSB-203L	1SFA616080R2034	6/146
KSB-203R	1SFA616080R2031	6/146
KSB-203Y	1SFA616080R2033	6/146
KSB-305G	1SFA616080R3052	6/146
KSB-305R	1SFA616080R3051	6/146
KSB-305Y	1SFA616080R3053	6/146
KSB-306G	1SFA616080R3062	6/146
KSB-306R	1SFA616080R3061	6/146
KSB-306Y	1SFA616080R3063	6/146
KSB-307G	1SFA616080R3072	6/146
KSB-307R	1SFA616080R3071	6/146
KSB-307Y	1SFA616080R3073	6/146
KSB-401C	1SFA616080R4018	6/146
KSB-401G	1SFA616080R4012	6/146
KSB-401L	1SFA616080R4014	6/146
KSB-401R	1SFA616080R4011	6/146
KSB-401Y	1SFA616080R4013	6/146
KT70-1001	1SFA616075R1001	6/145
KT70-1002	1SFA616075R1002	6/145
KTC1-1019	1SFA616901R1019	5/138
KTC1-1020	1SFA616901R1020	5/138
KTC1-1025	1SFA616901R1025	5/138
KTC1-1031	1SFA616901R1031	5/138
KTC1-1039	1SFA616901R1039	5/138
KTC15-1005	1SFA616915R1005	5/136
KTC15-1038	1SFA616915R1038	5/136
KTC15-6005	1SFA616915R6005	5/136
KTC1-9000	1SFA616901R9000	5/138
KTC1-9002	1SFA616901R9002	5/138
KTC1-9003	1SFA616901R9003	5/138
KTC1-9004	1SFA616901R9004	5/138
KTC1-9005	1SFA616901R9005	5/138
KTC1-9006	1SFA616901R9006	5/138
KTC1-9009	1SFA616901R9009	5/138
KTC1-9016	1SFA616901R9016	5/138
KTC1-9020	1SFA616901R9020	5/138
KTC1-9026	1SFA616901R9026	5/138
KTC1-9028	1SFA616901R9028	5/138
KTC2-1020	1SFA616902R1020	5/138
KTC2-1025	1SFA616902R1025	5/138
KTC2-1031	1SFA616902R1031	5/138
KTC2-9000	1SFA616902R9000	5/138
KTC2-9002	1SFA616902R9002	5/138
KTC2-9003	1SFA616902R9003	5/138
KTC2-9005	1SFA616902R9005	5/138
KTC2-9006	1SFA616902R9006	5/138
KTC2-9015	1SFA616902R9015	5/138
KTC2-9016	1SFA616902R9016	5/138
KTC2-9028	1SFA616902R9028	5/138
KTC3-1019	1SFA616903R1019	5/138
KTC3-1020	1SFA616903R1020	5/138
KTC3-1039	1SFA616903R1039	5/138
KTC3-9000	1SFA616903R9000	5/138
KTC3-9002	1SFA616903R9002	5/138
KTC4-1047	1SFA616904R1047	5/138
KTC4-9004	1SFA616904R9004	5/138
KTC5-1040	1SFA616905R1040	5/138
KTC5-1047	1SFA616905R1047	5/138

Index

Type classification

Type	Order code	Page	Type	Order code	Page	Type	Order code	Page
KTC5-9004	1SFA616905R9004	5/138	M2SS4-11G	1SFA611203R1102	2/33	M3SS1-11C	1SFA611210R1108	2/34
KTC6-1039	1SFA616906R1039	5/138	M2SS4-11L	1SFA611203R1104	2/33	M3SS1-11G	1SFA611210R1102	2/34
KTC6-1042	1SFA616906R1042	5/138	M2SS4-11R	1SFA611203R1101	2/33	M3SS1-11L	1SFA611210R1104	2/34
KTC6-9002	1SFA616906R9002	5/138	M2SS4-11Y	1SFA611203R1103	2/33	M3SS1-11R	1SFA611210R1101	2/34
KTC8-1039	1SFA616908R1039	5/138	M2SS4-20B	1SFA611203R2006	2/27	M3SS1-11Y	1SFA611210R1103	2/34
KTC8-9002	1SFA616908R9002	5/138	M2SS4-20R	1SFA611203R2001	2/27	M3SS1-20B	1SFA611210R2006	2/28
KTC8-9003	1SFA616908R9003	5/138	M2SS4-20U	1SFA611203R2007	2/27	M3SS1-20R	1SFA611210R2001	2/28
KTC8-9004	1SFA616908R9004	5/138	M2SS4-21C	1SFA611203R2108	2/33	M3SS1-20U	1SFA611210R2007	2/28
KTC8-9005	1SFA616908R9005	5/138	M2SS4-21G	1SFA611203R2102	2/33	M3SS1-21C	1SFA611210R2108	2/34
KTC8-9011	1SFA616908R9011	5/138	M2SS4-21L	1SFA611203R2104	2/33	M3SS1-21G	1SFA611210R2102	2/34
KTC8-9012	1SFA616908R9012	5/138	M2SS4-21R	1SFA611203R2103	2/33	M3SS1-21L	1SFA611210R2104	2/34
KTC8-9015	1SFA616908R9015	5/138	M2SS4-21Y	1SFA611203R2103	2/33	M3SS1-21R	1SFA611210R2101	2/34
KTC8-9016	1SFA616908R9016	5/138	M2SS4-30B	1SFA611203R3006	2/27	M3SS1-21Y	1SFA611210R2103	2/34
KTC8-9018	1SFA616908R9018	5/138	M2SS4-31C	1SFA611203R3108	2/33	M3SS1-30B	1SFA611210R3006	2/28
KTC8-9026	1SFA616908R9026	5/138	M2SS4-31G	1SFA611203R3102	2/33	M3SS1-30R	1SFA611210R3001	2/28
M2SS1-10B	1SFA611200R1006	2/26	M2SS5-10B	1SFA611204R1006	2/27	M3SS1-30U	1SFA611210R3007	2/28
M2SS1-10R	1SFA611200R1001	2/26	M2SS5-10R	1SFA611204R1001	2/27	M3SS1-31C	1SFA611210R3108	2/34
M2SS1-10U	1SFA611200R1007	2/26	M2SS5-10U	1SFA611204R1007	2/27	M3SS1-31G	1SFA611210R3102	2/34
M2SS1-11C	1SFA611200R1108	2/32	M2SS5-11C	1SFA611204R1108	2/33	M3SS1-31L	1SFA611210R3104	2/34
M2SS1-11G	1SFA611200R1102	2/32	M2SS5-11G	1SFA611204R1102	2/33	M3SS1-31R	1SFA611210R3101	2/34
M2SS1-11L	1SFA611200R1104	2/32	M2SS5-11L	1SFA611204R1104	2/33	M3SS1-31Y	1SFA611210R3103	2/34
M2SS1-11R	1SFA611200R1101	2/32	M2SS5-11R	1SFA611204R1101	2/33	M3SS2-10B	1SFA611211R1006	2/28
M2SS1-11Y	1SFA611200R1103	2/32	M2SS5-11Y	1SFA611204R1103	2/33	M3SS2-10R	1SFA611211R1001	2/28
M2SS1-20B	1SFA611200R2006	2/26	M2SS5-20B	1SFA611204R2006	2/27	M3SS2-10U	1SFA611211R1007	2/28
M2SS1-20R	1SFA611200R2001	2/26	M2SS5-20R	1SFA611204R2001	2/27	M3SS2-11C	1SFA611211R1108	2/34
M2SS1-20U	1SFA611200R2007	2/26	M2SS5-20U	1SFA611204R2007	2/27	M3SS2-11G	1SFA611211R1102	2/34
M2SS1-21C	1SFA611200R2108	2/32	M2SS5-21C	1SFA611204R2108	2/33	M3SS2-11L	1SFA611211R1104	2/34
M2SS1-21G	1SFA611200R2102	2/32	M2SS5-21G	1SFA611204R2102	2/33	M3SS2-11R	1SFA611211R1101	2/34
M2SS1-21L	1SFA611200R2104	2/32	M2SS5-21L	1SFA611204R2104	2/33	M3SS2-11Y	1SFA611211R1103	2/34
M2SS1-21R	1SFA611200R2101	2/32	M2SS5-21R	1SFA611204R2101	2/33	M3SS2-20B	1SFA611211R2006	2/28
M2SS1-21Y	1SFA611200R2103	2/32	M2SS5-21Y	1SFA611204R2103	2/33	M3SS2-20R	1SFA611211R2001	2/28
M2SS1-30B	1SFA611200R3006	2/26	M2SS5-30B	1SFA611204R3006	2/27	M3SS2-20U	1SFA611211R2007	2/28
M2SS1-30R	1SFA611200R3001	2/26	M2SS5-30R	1SFA611204R3001	2/27	M3SS2-21C	1SFA611211R2108	2/34
M2SS1-31C	1SFA611200R3108	2/32	M2SS5-31C	1SFA611204R3108	2/33	M3SS2-21G	1SFA611211R2102	2/34
M2SS1-31G	1SFA611200R3102	2/32	M2SS5-31G	1SFA611204R3102	2/33	M3SS2-21L	1SFA611211R2104	2/34
M2SS1-31R	1SFA611200R3101	2/32	M2SS5-31L	1SFA611204R3104	2/33	M3SS2-21R	1SFA611211R2101	2/34
M2SS1-31Y	1SFA611200R3103	2/32	M2SS5-31R	1SFA611204R3101	2/33	M3SS2-21Y	1SFA611211R2103	2/34
M2SS2-10B	1SFA611201R1006	2/26	M2SS5-31Y	1SFA611204R3103	2/33	M3SS2-30B	1SFA611211R3006	2/28
M2SS2-10R	1SFA611201R1001	2/26	M2SS6-10B	1SFA611205R1006	2/27	M3SS2-30R	1SFA611211R3001	2/28
M2SS2-10U	1SFA611201R1007	2/26	M2SS6-10R	1SFA611205R1001	2/27	M3SS2-31C	1SFA611211R3108	2/34
M2SS2-11C	1SFA611201R1108	2/32	M2SS6-10U	1SFA611205R1007	2/27	M3SS2-31G	1SFA611211R3102	2/34
M2SS2-11G	1SFA611201R1102	2/32	M2SS6-11C	1SFA611205R1108	2/33	M3SS2-31L	1SFA611211R3104	2/34
M2SS2-11L	1SFA611201R1104	2/32	M2SS6-11G	1SFA611205R1102	2/33	M3SS2-31R	1SFA611211R3101	2/34
M2SS2-11R	1SFA611201R1101	2/32	M2SS6-11L	1SFA611205R1104	2/33	M3SS3-10B	1SFA611212R1006	2/28
M2SS2-11Y	1SFA611201R1103	2/32	M2SS6-11R	1SFA611205R1101	2/33	M3SS3-10R	1SFA611212R1001	2/28
M2SS2-20B	1SFA611201R2006	2/26	M2SS6-11Y	1SFA611205R1103	2/33	M3SS3-10U	1SFA611212R1007	2/28
M2SS2-20R	1SFA611201R2001	2/26	M2SS6-20B	1SFA611205R2006	2/27	M3SS3-11C	1SFA611212R1108	2/34
M2SS2-20U	1SFA611201R2007	2/26	M2SS6-20R	1SFA611205R2001	2/27	M3SS3-11G	1SFA611212R1102	2/34
M2SS2-21C	1SFA611201R2108	2/32	M2SS6-30B	1SFA611205R3006	2/27	M3SS3-11L	1SFA611212R1104	2/34
M2SS2-21G	1SFA611201R2102	2/32	M2SS6-31C	1SFA611205R3108	2/33	M3SS3-11R	1SFA611212R1101	2/34
M2SS2-21L	1SFA611201R2104	2/32	M2SSK1-101	1SFA611280R1001	2/36	M3SS3-11Y	1SFA611212R1103	2/34
M2SS2-21R	1SFA611201R2101	2/32	M2SSK1-102	1SFA611280R1002	2/36	M3SS3-20B	1SFA611212R2006	2/28
M2SS2-21Y	1SFA611201R2103	2/32	M2SSK1-103	1SFA611280R1003	2/36	M3SS3-20U	1SFA611212R2007	2/28
M2SS2-30B	1SFA611201R3006	2/26	M2SSK1-104	1SFA611280R1004	2/36	M3SS3-21C	1SFA611212R2108	2/34
M2SS2-30R	1SFA611201R3001	2/26	M2SSK1-201	1SFA611280R2001	2/36	M3SS3-21G	1SFA611212R2102	2/34
M2SS2-30U	1SFA611201R3007	2/26	M2SSK1-301	1SFA611280R3001	2/36	M3SS3-21R	1SFA611212R2101	2/34
M2SS2-31C	1SFA611201R3108	2/32	M2SSK1-302	1SFA611280R3002	2/36	M3SS3-30B	1SFA611212R3006	2/28
M2SS2-31G	1SFA611201R3102	2/32	M2SSK1-303	1SFA611280R3003	2/36	M3SS3-31C	1SFA611212R3108	2/34
M2SS2-31L	1SFA611201R3104	2/32	M2SSK1-304	1SFA611280R3004	2/36	M3SS4-10B	1SFA611213R1006	2/29
M2SS2-31R	1SFA611201R3101	2/32	M2SSK2-101	1SFA611281R1001	2/36	M3SS4-10R	1SFA611213R1001	2/29
M2SS2-31Y	1SFA611201R3103	2/32	M2SSK2-102	1SFA611281R1002	2/36	M3SS4-10U	1SFA611213R1007	2/29
M2SS3-10B	1SFA611202R1006	2/26	M2SSK2-103	1SFA611281R1003	2/36	M3SS4-11C	1SFA611213R1108	2/35
M2SS3-10R	1SFA611202R1001	2/26	M2SSK2-104	1SFA611281R1004	2/36	M3SS4-11G	1SFA611213R1102	2/35
M2SS3-10U	1SFA611202R1007	2/26	M2SSK2-201	1SFA611281R2001	2/36	M3SS4-11L	1SFA611213R1104	2/35
M2SS3-11C	1SFA611202R1108	2/32	M2SSK2-203	1SFA611281R2003	2/36	M3SS4-11R	1SFA611213R1101	2/35
M2SS3-11G	1SFA611202R1102	2/32	M2SSK2-301	1SFA611281R3001	2/36	M3SS4-11Y	1SFA611213R1103	2/35
M2SS3-11L	1SFA611202R1104	2/32	M2SSK2-302	1SFA611281R3002	2/36	M3SS4-20B	1SFA611213R2006	2/29
M2SS3-11R	1SFA611202R1101	2/32	M2SSK2-303	1SFA611281R3003	2/36	M3SS4-20R	1SFA611213R2001	2/29
M2SS3-11Y	1SFA611202R1103	2/32	M2SSK2-304	1SFA611281R3004	2/36	M3SS4-20U	1SFA611213R2007	2/29
M2SS3-20B	1SFA611202R2006	2/26	M2SSK3-101	1SFA611282R1001	2/36	M3SS4-21C	1SFA611213R2108	2/35
M2SS3-20R	1SFA611202R2001	2/26	M2SSK3-102	1SFA611282R1002	2/36	M3SS4-21G	1SFA611213R2102	2/35
M2SS3-20U	1SFA611202R2007	2/26	M2SSK3-103	1SFA611282R1003	2/36	M3SS4-21L	1SFA611213R2104	2/35
M2SS3-21G	1SFA611202R2102	2/32	M2SSK3-104	1SFA611282R1004	2/36	M3SS4-21R	1SFA611213R2101	2/35
M2SS3-21R	1SFA611202R2101	2/32	M2SSK3-301	1SFA611282R3001	2/36	M3SS4-21Y	1SFA611213R2103	2/35
M2SS3-30B	1SFA611202R3006	2/26	M2SSK3-302	1SFA611282R3002	2/36	M3SS4-30B	1SFA611213R3006	2/29
M2SS3-30R	1SFA611202R3001	2/26	M2SSK3-303	1SFA611282R3003	2/36	M3SS4-31C	1SFA611213R3108	2/35
M2SS3-31C	1SFA611202R3108	2/32	M2SSK3-304	1SFA611282R3004	2/36	M3SS4-31R	1SFA611213R3101	2/35
M2SS3-31G	1SFA611202R3102	2/32	M2SSK4-101	1SFA611289R1001	2/36	M3SS5-10B	1SFA611214R1006	2/29
M2SS3-31R	1SFA611202R3101	2/32	M2SSV1-10B	1SFA611220R1006	4/129	M3SS5-10R	1SFA611214R1001	2/29
M2SS3-31Y	1SFA611202R3103	2/32	M2SSV2-10B	1SFA611221R1006	4/129	M3SS5-10U	1SFA611214R1007	2/29
M2SS4-10B	1SFA611203R1006	2/27	M2SSV3-10B	1SFA611222R1006	4/129	M3SS5-11C	1SFA611214R1108	2/35
M2SS4-10R	1SFA611203R1001	2/27	M3SS1-10B	1SFA611210R1006	2/28	M3SS5-11G	1SFA611214R1102	2/35
M2SS4-10U	1SFA611203R1007	2/27	M3SS1-10R	1SFA611210R1001	2/28	M3SS5-11L	1SFA611214R1104	2/35
M2SS4-11C	1SFA611203R1108	2/33	M3SS1-10U	1SFA611210R1007	2/28	M3SS5-11R	1SFA611214R1101	2/35

Index

Type classification

Type	Order code	Page
M3SS5-11Y	1SFA611214R1103	2/35
M3SS5-20B	1SFA611214R2006	2/29
M3SS5-20U	1SFA611214R2007	2/29
M3SS5-21C	1SFA611214R2108	2/35
M3SS5-21G	1SFA611214R2102	2/35
M3SS5-21L	1SFA611214R2104	2/35
M3SS5-21R	1SFA611214R2101	2/35
M3SS5-21Y	1SFA611214R2103	2/35
M3SS5-30B	1SFA611214R3006	2/29
M3SS5-30R	1SFA611214R3001	2/29
M3SS5-31C	1SFA611214R3108	2/35
M3SS5-31G	1SFA611214R3102	2/35
M3SS6-10B	1SFA611215R1006	2/29
M3SS6-10R	1SFA611215R1001	2/29
M3SS6-10U	1SFA611215R1007	2/29
M3SS6-11C	1SFA611215R1108	2/35
M3SS6-11G	1SFA611215R1102	2/35
M3SS6-11L	1SFA611215R1104	2/35
M3SS6-11R	1SFA611215R1101	2/35
M3SS6-11Y	1SFA611215R1103	2/35
M3SS6-20B	1SFA611215R2006	2/29
M3SS6-21G	1SFA611215R2102	2/35
M3SS6-21Y	1SFA611215R2103	2/35
M3SS6-30B	1SFA611215R3006	2/29
M3SS6-31L	1SFA611215R3104	2/35
M3SS7-10B	1SFA611216R1006	2/28
M3SS7-10R	1SFA611216R1001	2/28
M3SS7-10U	1SFA611216R1007	2/28
M3SS7-11C	1SFA611216R1108	2/34
M3SS7-11G	1SFA611216R1102	2/34
M3SS7-11L	1SFA611216R1104	2/34
M3SS7-11R	1SFA611216R1101	2/34
M3SS7-11Y	1SFA611216R1103	2/34
M3SS7-20B	1SFA611216R2006	2/28
M3SS7-20R	1SFA611216R2001	2/28
M3SS7-21C	1SFA611216R2108	2/34
M3SS7-21G	1SFA611216R2102	2/34
M3SS7-21L	1SFA611216R2104	2/34
M3SS7-30B	1SFA611216R3006	2/28
M3SS7-31C	1SFA611216R3108	2/34
M3SS7-31G	1SFA611216R3102	2/34
M3SS8-10B	1SFA611217R1006	2/29
M3SS8-10R	1SFA611217R1001	2/29
M3SS8-10U	1SFA611217R1007	2/29
M3SS8-11C	1SFA611217R1108	2/35
M3SS8-11G	1SFA611217R1102	2/35
M3SS8-11L	1SFA611217R1104	2/35
M3SS8-11R	1SFA611217R1101	2/35
M3SS8-11Y	1SFA611217R1103	2/35
M3SS8-20B	1SFA611217R2006	2/29
M3SS8-21G	1SFA611217R2102	2/35
M3SS8-21R	1SFA611217R2101	2/35
M3SS8-30B	1SFA611217R3006	2/29
M3SS8-31G	1SFA611217R3102	2/35
M3SS8-31R	1SFA611217R3101	2/35
M3SSC1-10B	1SFA611250R1006	2/30
M3SSC1-30B	1SFA611250R3006	2/30
M3SSC2-10B	1SFA611251R1006	2/30
M3SSC2-30B	1SFA611251R3006	2/30
M3SSC3-10B	1SFA611252R1006	2/30
M3SSC3-30B	1SFA611252R3006	2/30
M3SSC7-10B	1SFA611256R1006	2/30
M3SSC7-30B	1SFA611256R3006	2/30
M3SSK1-101	1SFA611283R1001	2/37
M3SSK1-102	1SFA611283R1002	2/37
M3SSK1-103	1SFA611283R1003	2/37
M3SSK1-104	1SFA611283R1004	2/37
M3SSK1-201	1SFA611283R2001	2/37
M3SSK1-301	1SFA611283R3001	2/37
M3SSK1-302	1SFA611283R3002	2/37
M3SSK1-303	1SFA611283R3003	2/37
M3SSK1-304	1SFA611283R3004	2/37
M3SSK2-101	1SFA611284R1001	2/37
M3SSK2-102	1SFA611284R1002	2/37
M3SSK2-103	1SFA611284R1003	2/37
M3SSK2-104	1SFA611284R1004	2/37
M3SSK2-301	1SFA611284R3001	2/37
M3SSK3-101	1SFA611285R1001	2/37
M3SSK3-102	1SFA611285R1002	2/37
M3SSK3-103	1SFA611285R1003	2/37
M3SSK3-104	1SFA611285R1004	2/37
M3SSK3-301	1SFA611285R3001	2/37
M3SSK3-302	1SFA611285R3002	2/37
M3SSK3-303	1SFA611285R3003	2/37

Type	Order code	Page
M3SSK4-101	1SFA611286R1001	2/37
M3SSK4-102	1SFA611286R1002	2/37
M3SSK4-301	1SFA611286R3001	2/37
M3SSK4-302	1SFA611286R3002	2/37
M3SSK5-101	1SFA611287R1001	2/37
M3SSK5-103	1SFA611287R1003	2/37
M3SSK5-301	1SFA611287R3001	2/37
M3SSK6-101	1SFA611288R1001	2/37
M3SSV1-10B	1SFA611230R1006	4/129
M3SSV2-10B	1SFA611231R1006	4/129
M3SSV3-10B	1SFA611232R1006	4/129
M4SS1-10B	1SFA611290R4006	2/31
M4SS1-10R	1SFA611290R4001	2/31
M4SS1-30B	1SFA611290R6006	2/31
M4SS1-30R	1SFA611290R6001	2/31
M4SS2-10B	1SFA611291R4006	2/31
M4SS2-10R	1SFA611291R4001	2/31
M4SS2-30B	1SFA611291R6006	2/31
M4SS2-30R	1SFA611291R6001	2/31
MA16-1000	1SFA611940R1000	5/137
MA16-1001	1SFA611940R1001	5/137
MA1-8001	1SFA611920R8001	2/48
MA1-8002	1SFA611920R8002	2/47
MA1-8002	1SFA611920R8002	3/110
MA1-8015	1SFA611920R8015	2/48
MA1-8015	1SFA611920R8015	3/111
MA1-8019	1SFA611920R8019	2/48
MA1-8019	1SFA611920R8019	3/111
MA1-8052	1SFA611920R8052	2/47
MA1-8052	1SFA611920R8052	3/110
MA1-8053	1SFA611920R8053	2/47
MA1-8053	1SFA611920R8053	4/123
MA1-8074	1SFA611920R8074	2/47
MA1-8074	1SFA611920R8074	3/110
MA1-8126	1SFA611920R8126	2/47
MA1-8128	1SFA611920R8128	2/47
MA1-8128	1SFA611920R8128	4/123
MA1-8129	1SFA611920R8129	4/124
MA1-8130	1SFA611920R8130	4/124
MA1-8131	1SFA611920R8131	2/48
MA1-8136	1SFA611920R8136	4/124
MA1-8137	1SFA611920R8137	2/41
MA1-8138	1SFA611920R8138	2/41
MA1-8139	1SFA611920R8139	2/19
MA1-8139	1SFA611920R8139	2/20
MA1-8139	1SFA611920R8139	2/21
MA1-8149	1SFA611920R8149	2/48
MA1-8149	1SFA611920R8149	3/111
MA1-8150	1SFA611920H8150	4/124
MA1-8152	1SFA611920R8152	2/47
MA1-8152	1SFA611920R8152	3/110
MA1-8153	1SFA611920R8153	2/47
MA1-8153	1SFA611920R8153	3/110
MA1-8160	1SFA611920R8160	4/124
MA5-3001	1SFA611925R3001	4/124
MA5-3002	1SFA611925R3002	4/124
MA5-3003	1SFA611925R3003	4/124
MA5-3004	1SFA611925R3004	4/124
MA5-3006	1SFA611925R3006	4/124
MA5-3007	1SFA611925R3007	4/124
MA5-3008	1SFA611925R3008	4/124
MA5-3009	1SFA611925R3009	4/124
MA5-3010	1SFA611925R3010	4/124
MA6-1000	1SFA611930R1000	4/128
MA6-1002	1SFA611930R1002	4/128
MA6-1003	1SFA611930R1003	4/128
MA6-1004	1SFA611930R1004	4/128
MA6-1005	1SFA611930R1005	4/128
MA6-1006	1SFA611930R1006	4/128
MA6-1007	1SFA611930R1007	4/128
MA6-1008	1SFA611930R1008	4/128
MA6-1009	1SFA611930R1009	4/128
MA6-1010	1SFA611930R1010	5/136
MA6-1011	1SFA611930R1011	5/136
MA6-1012	1SFA611930R1012	4/128
MA6-1013	1SFA611930R1013	4/128
MA6-1014	1SFA611930R1014	4/128
MA6-1015	1SFA611930R1015	4/128
MA6-1016	1SFA611930R1016	4/128
MA6-1017	1SFA611930R1017	5/136
MA6-1018	1SFA611930R1018	5/136
MA6-1019	1SFA611930R1019	5/136
MA6-1020	1SFA611930R1020	5/136
MA6-1021	1SFA611930R1021	5/136

Type	Order code	Page
MA6-1022	1SFA611930R1022	5/136
MA6-1023	1SFA611930R1023	5/136
MA6-1024	1SFA611930R1024	4/128
MA6-1025	1SFA611930R1025	4/128
MA6-1026	1SFA611930R1026	4/128
MA6-1027	1SFA611930R1027	4/128
MA6-1028	1SFA611930R1028	4/128
MA6-1029	1SFA611930R1029	4/128
MA6-1032	1SFA611930R1032	5/135
MA6-1033	1SFA611930R1033	5/135
MA6-1034	1SFA611930R1034	5/135
MA6-1035	1SFA611930R1035	5/135
MA6-1036	1SFA611930R1036	5/135
MA6-1037	1SFA611930R1037	5/135
MA6-1038	1SFA611930R1038	5/135
MA6-1039	1SFA611930R1039	5/135
MA6-1040	1SFA611930R1040	5/135
MA6-1041	1SFA611930R1041	5/135
MA6-1042	1SFA611930R1042	5/135
MA6-1043	1SFA611930R1043	5/135
MA6-1044	1SFA611930R1044	5/135
MA6-1045	1SFA611930R1045	5/135
MA6-1047	1SFA611930R1047	5/135
MA6-1054	1SFA611930R1054	5/135
MA6-1058	1SFA611930R1058	5/135
MA6-1060	1SFA611930R1060	4/127
MA6-1061	1SFA611930R1061	4/127
MA6-1062	1SFA611930R1062	4/127
MA6-1063	1SFA611930R1063	4/127
MA6-1064	1SFA611930R1064	4/127
MA6-1065	1SFA611930R1065	4/127
MA6-1070	1SFA611930R1070	5/135
MA6-1071	1SFA611930R1071	5/135
MA6-1073	1SFA611930R1073	5/135
MA6-1074	1SFA611930R1074	5/135
MA6-1075	1SFA611930R1075	5/135
MA6-1076	1SFA611930R1076	5/135
MA6-1077	1SFA611930R1077	5/135
MA6-1079	1SFA611930R1079	5/135
MA6-1080	1SFA611930R1080	5/135
MA6-1082	1SFA611930R1082	5/135
MA6-1083	1SFA611930R1083	5/135
MA6-1084	1SFA611930R1084	5/135
MA6-1085	1SFA611930R1085	5/135
MA6-1086	1SFA611930R1086	5/135
MA6-1087	1SFA611930R1087	5/135
MA6-1100	1SFA611930R1100	4/128
MA6-1101	1SFA611930R1101	4/128
MA6-1102	1SFA611930R1102	4/128
MA6-1103	1SFA611930R1103	4/128
MA6-1104	1SFA611930R1104	4/128
MA6-1118	1SFA611930R1118	5/135
MA6-1130	1SFA611930R1130	4/127
MA6-1131	1SFA611930R1131	4/127
MA6-1132	1SFA611930R1132	4/127
MA6-1134	1SFA611930R1134	4/127
MA6-1135	1SFA611930R1135	4/127
MA6-1136	1SFA611930R1136	4/127
MA6-1137	1SFA611930R1137	4/127
MA6-1138	1SFA611930R1138	4/127
MA6-1139	1SFA611930R1139	4/127
MA6-1140	1SFA611930R1140	4/127
MA6-1141	1SFA611930R1141	4/127
MA6-1152	1SFA611930R1152	4/127
MA6-1153	1SFA611930R1153	4/127
MA6-1170	1SFA611930R1170	4/127
MA6-1171	1SFA611930R1171	4/127
MA6-1172	1SFA611930R1172	4/127
MA6-1173	1SFA611930R1173	4/127
MA6-1174	1SFA611930R1174	4/127
MA6-1175	1SFA611930R1175	4/127
MA6-1176	1SFA611930R1176	4/127
MA6-1177	1SFA611930R1177	4/127
MA6-1178	1SFA611930R1178	4/127
MA6-1179	1SFA611930R1179	4/127
MA6-1190	1SFA611930R1190	4/127
MA6-1191	1SFA611930R1191	4/127
MA6-1192	1SFA611930R1192	4/127
MA6-1193	1SFA611930R1193	4/127
MA6-1194	1SFA611930R1194	4/127
MA6-1210	1SFA611930R1210	5/135
MA6-1240	1SFA611930R1240	2/41
MA6-1241	1SFA611930R1241	2/41

Index

Type classification

Type	Order code	Page	Type	Order code	Page	Type	Order code	Page
MA6-1242	1SFA611930R1242	2/41	MLBL-02BG	1SFA611621R2022	4/125	MLBL-09Y	1SFA611621R1093	2/46
MA6-1252	1SFA611930R1252	2/38	MLBL-02BL	1SFA611621R2024	4/125	MLBL-99G	1SFA611621R1992	2/46
MCB-01	1SFA611610R1010	2/44	MLBL-02BR	1SFA611621R2021	4/125	MLBL-99L	1SFA611621R1994	2/46
MCB-01B	1SFA611610R2010	4/124	MLBL-02BW	1SFA611621R2025	4/125	MLBL-99R	1SFA611621R1991	2/46
MCB-01BG	1SFA611610R2110	4/124	MLBL-02BY	1SFA611621R2023	4/125	MLBL-99W	1SFA611621R1995	2/46
MCB-01G	1SFA611610R1110	2/44	MLBL-02G	1SFA611621R1022	2/45	MLBL-99Y	1SFA611621R1993	2/46
MCB-02	1SFA611610R1020	2/44	MLBL-02L	1SFA611621R1024	2/45	MP1-10B	1SFA611100R1006	2/15
MCB-02B	1SFA611610R2020	4/124	MLBL-02R	1SFA611621R1021	2/45	MP1-10C	1SFA611100R1008	2/15
MCB-02G	1SFA611610R1120	2/44	MLBL-02W	1SFA611621R1025	2/45	MP1-10G	1SFA611100R1002	2/15
MCB-10	1SFA611610R1001	2/44	MLBL-02Y	1SFA611621R1023	2/45	MP1-10L	1SFA611100R1004	2/15
MCB-10B	1SFA611610R2001	4/124	MLBL-03BG	1SFA611621R2032	4/125	MP1-10R	1SFA611100R1001	2/15
MCB-10BG	1SFA611610R2101	4/124	MLBL-03BL	1SFA611621R2034	4/125	MP1-10W	1SFA611100R1005	2/15
MCB-10G	1SFA611610R1101	2/44	MLBL-03BR	1SFA611621R2031	4/125	MP1-10Y	1SFA611100R1003	2/15
MCB-11	1SFA611610R1011	2/44	MLBL-03BW	1SFA611621R2035	4/125	MP1-11C	1SFA611100R1108	2/17
MCB-11B	1SFA611610R2011	4/124	MLBL-03BY	1SFA611621R2033	4/125	MP1-11G	1SFA611100R1102	2/17
MCB-11G	1SFA611610R1111	2/44	MLBL-03G	1SFA611621R1032	2/45	MP1-11L	1SFA611100R1104	2/17
MCB-20	1SFA611610R1002	2/44	MLBL-03L	1SFA611621R1034	2/45	MP1-11R	1SFA611100R1101	2/17
MCB-20B	1SFA611610R2002	4/124	MLBL-03R	1SFA611621R1031	2/45	MP1-11W	1SFA611100R1105	2/17
MCB-20G	1SFA611610R1102	2/44	MLBL-03W	1SFA611621R1035	2/45	MP1-11Y	1SFA611100R1103	2/17
MCBH-00	1SFA611605R1100	2/44	MLBL-03Y	1SFA611621R1033	2/45	MP1-20B	1SFA611100R2006	2/15
MCBH5-00	1SFA611601R1000	2/44	MLBL-04AG	1SFA611621R3042	2/45	MP1-20C	1SFA611100R2008	2/15
MCBL-01	1SFA611612R1001	2/44	MLBL-04AL	1SFA611621R3044	2/45	MP1-20G	1SFA611100R2002	2/15
MCBL-10	1SFA611612R1010	2/44	MLBL-04AR	1SFA611621R3041	2/45	MP1-20L	1SFA611100R2004	2/15
MDB-2	1SFA611630R1002	2/48	MLBL-04AW	1SFA611621R3045	2/45	MP1-20R	1SFA611100R2001	2/15
MEP1-0	1SFA611811R1000	4/123	MLBL-04AY	1SFA611621R3043	2/45	MP1-20W	1SFA611100R2005	2/15
MEP2-0	1SFA611812R1000	4/123	MLBL-04BG	1SFA611621R2042	4/125	MP1-20Y	1SFA611100R2003	2/15
MEP2-1001	1SFA611812R1001	4/130	MLBL-04BL	1SFA611621R2044	4/125	MP1-21C	1SFA611100R2108	2/17
MEP3-0	1SFA611813R1000	4/123	MLBL-04BR	1SFA611621R2041	4/125	MP1-21G	1SFA611100R2102	2/17
MEP4-0	1SFA611814R1000	4/123	MLBL-04BW	1SFA611621R2045	4/125	MP1-21L	1SFA611100R2104	2/17
MEP6-0	1SFA611816R1000	4/123	MLBL-04BY	1SFA611621R2043	4/125	MP1-21R	1SFA611100R2101	2/17
MEPY1-0	1SFA611821R1000	4/123	MLBL-04G	1SFA611621R1042	2/45	MP1-21W	1SFA611100R2105	2/17
MEPY1-1035	1SFA611821R1035	4/130	MLBL-04L	1SFA611621R1044	2/45	MP1-21Y	1SFA611100R2103	2/17
MEPY1-1040	1SFA611821R1040	4/130	MLBL-04R	1SFA611621R1041	2/45	MP1-30B	1SFA611100R3006	2/15
MEPY1-1041	1SFA611821R1041	4/130	MLBL-04W	1SFA611621R1045	2/45	MP1-30C	1SFA611100R3008	2/15
MEPY1-1042	1SFA611821R1042	4/130	MLBL-04Y	1SFA611621R1043	2/45	MP1-30G	1SFA611100R3002	2/15
MJS10-60B	1SFA611710R6006	2/41	MLBL-05BG	1SFA611621R2052	4/125	MP1-30L	1SFA611100R3004	2/15
MJS11-40B	1SFA611711R4006	2/41	MLBL-05BL	1SFA611621R2054	4/125	MP1-30R	1SFA611100R3001	2/15
MJS11-60B	1SFA611711R6006	2/41	MLBL-05BR	1SFA611621R2051	4/125	MP1-30W	1SFA611100R3005	2/15
MJS12-40B	1SFA611712R4006	2/41	MLBL-05BW	1SFA611621R2055	4/125	MP1-30Y	1SFA611100R3003	2/15
MJS12-60B	1SFA611712R6006	2/41	MLBL-05BY	1SFA611621R2053	4/125	MP1-31C	1SFA611100R3108	2/17
MJS1-40B	1SFA611701R4006	2/41	MLBL-05G	1SFA611621R1052	2/45	MP1-31G	1SFA611100R3102	2/17
MJS1-60B	1SFA611701R6006	2/41	MLBL-05L	1SFA611621R1054	2/45	MP1-31L	1SFA611100R3104	2/17
MJS2-40B	1SFA611702R4006	2/41	MLBL-05R	1SFA611621R1051	2/45	MP1-31R	1SFA611100R3101	2/17
MJS2-60B	1SFA611702R6006	2/41	MLBL-05W	1SFA611621R1055	2/45	MP1-31W	1SFA611100R3105	2/17
MJS3-40B	1SFA611703R4006	2/41	MLBL-05Y	1SFA611621R1053	2/45	MP1-31Y	1SFA611100R3103	2/17
MJS3-60B	1SFA611703R6006	2/41	MLBL-06BG	1SFA611621R2062	4/125	MP2-10B	1SFA611101R1006	2/15
MJS4-40B	1SFA611704R4006	2/41	MLBL-06BL	1SFA611621R2064	4/125	MP2-10C	1SFA611101R1008	2/15
MJS4-60B	1SFA611704R6006	2/41	MLBL-06BR	1SFA611621R2061	4/125	MP2-10G	1SFA611101R1002	2/15
MJS5-40B	1SFA611705R4006	2/41	MLBL-06BW	1SFA611621R2065	4/125	MP2-10L	1SFA611101R1004	2/15
MJS5-60B	1SFA611705R6006	2/41	MLBL-06BY	1SFA611621R2063	4/125	MP2-10R	1SFA611101R1001	2/15
MJS6-40B	1SFA611706R4006	2/41	MLBL-06G	1SFA611621R1062	2/45	MP2-10W	1SFA611101R1005	2/15
MJS6-60B	1SFA611706R6006	2/41	MLBL-06L	1SFA611621R1064	2/45	MP2-10Y	1SFA611101R1003	2/15
MJS7-40B	1SFA611707R4006	2/41	MLBL-06R	1SFA611621R1061	2/45	MP2-11C	1SFA611101R1108	2/17
MJS7-60B	1SFA611707R6006	2/41	MLBL-06W	1SFA611621R1065	2/45	MP2-11G	1SFA611101R1102	2/17
MJS8-40B	1SFA611708R4006	2/41	MLBL-06Y	1SFA611621R1063	2/45	MP2-11L	1SFA611101R1104	2/17
MJS8-60B	1SFA611708R6006	2/41	MLBL-07BG	1SFA611621R2072	4/126	MP2-11R	1SFA611101R1101	2/17
MJS9-40B	1SFA611709R4006	2/41	MLBL-07BL	1SFA611621R2074	4/126	MP2-11W	1SFA611101R1105	2/17
MJS9-60B	1SFA611709R6006	2/41	MLBL-07BR	1SFA611621R2071	4/126	MP2-11Y	1SFA611101R1103	2/17
ML1-100C	1SFA611400R1008	2/25	MLBL-07BW	1SFA611621R2075	4/126	MP2-20B	1SFA611101R2006	2/15
ML1-100G	1SFA611400R1002	2/25	MLBL-07BY	1SFA611621R2073	4/126	MP2-20G	1SFA611101R2002	2/15
ML1-100L	1SFA611400R1004	2/25	MLBL-07G	1SFA611621R1072	2/46	MP2-20L	1SFA611101R2004	2/15
ML1-100R	1SFA611400R1001	2/25	MLBL-07L	1SFA611621R1074	2/46	MP2-20R	1SFA611101R2001	2/15
ML1-100W	1SFA611400R1005	2/25	MLBL-07R	1SFA611621R1071	2/46	MP2-20W	1SFA611101R2005	2/15
ML1-100Y	1SFA611400R1003	2/25	MLBL-07W	1SFA611621R1075	2/46	MP2-21G	1SFA611101R2102	2/17
MLBL-00BG	1SFA611621R2002	4/125	MLBL-07Y	1SFA611621R1073	2/46	MP2-21L	1SFA611101R2104	2/17
MLBL-00BL	1SFA611621R2004	4/125	MLBL-08BG	1SFA611621R2082	4/126	MP2-21R	1SFA611101R2101	2/17
MLBL-00BR	1SFA611621R2001	4/125	MLBL-08BL	1SFA611621R2084	4/126	MP2-21W	1SFA611101R2105	2/17
MLBL-00BW	1SFA611621R2005	4/125	MLBL-08BR	1SFA611621R2081	4/126	MP2-21Y	1SFA611101R2103	2/17
MLBL-00BY	1SFA611621R2003	4/125	MLBL-08BW	1SFA611621R2085	4/126	MP2-30B	1SFA611101R3006	2/15
MLBL-00G	1SFA611621R1002	2/45	MLBL-08BY	1SFA611621R2083	4/126	MP2-30G	1SFA611101R3002	2/15
MLBL-00L	1SFA611621R1004	2/45	MLBL-08G	1SFA611621R1082	2/46	MP2-30L	1SFA611101R3004	2/15
MLBL-00R	1SFA611621R1001	2/45	MLBL-08L	1SFA611621R1084	2/46	MP2-30R	1SFA611101R3001	2/15
MLBL-00W	1SFA611621R1005	2/45	MLBL-08R	1SFA611621R1081	2/46	MP2-30Y	1SFA611101R3003	2/15
MLBL-00Y	1SFA611621R1003	2/45	MLBL-08W	1SFA611621R1085	2/46	MP2-31C	1SFA611101R3108	2/17
MLBL-01BG	1SFA611621R2012	4/125	MLBL-08Y	1SFA611621R1083	2/46	MP2-31G	1SFA611101R3102	2/17
MLBL-01BL	1SFA611621R2014	4/125	MLBL-09BG	1SFA611621R2092	4/126	MP2-31L	1SFA611101R3104	2/17
MLBL-01BR	1SFA611621R2011	4/125	MLBL-09BL	1SFA611621R2094	4/126	MP2-31R	1SFA611101R3101	2/17
MLBL-01BW	1SFA611621R2015	4/125	MLBL-09BR	1SFA611621R2091	4/126	MP2-31W	1SFA611101R3105	2/17
MLBL-01BY	1SFA611621R2013	4/125	MLBL-09BW	1SFA611621R2095	4/126	MP2-31Y	1SFA611101R3103	2/17
MLBL-01G	1SFA611621R1012	2/45	MLBL-09BY	1SFA611621R2093	4/126	MP3-10B	1SFA611102R1006	2/16
MLBL-01L	1SFA611621R1014	2/45	MLBL-09G	1SFA611621R1092	2/46	MP3-10C	1SFA611102R1008	2/16
MLBL-01R	1SFA611621R1011	2/45	MLBL-09L	1SFA611621R1094	2/46	MP3-10G	1SFA611102R1002	2/16
MLBL-01W	1SFA611621R1015	2/45	MLBL-09R	1SFA611621R1091	2/46	MP3-10L	1SFA611102R1004	2/16
MLBL-01Y	1SFA611621R1013	2/45	MLBL-09W	1SFA611621R1095	2/46	MP3-10R	1SFA611102R1001	2/16

Index

Type classification

Type	Order code	Page
MP3-10W	1SFA611102R1005	2/16
MP3-10Y	1SFA611102R1003	2/16
MP3-11C	1SFA611102R1108	2/18
MP3-11G	1SFA611102R1102	2/18
MP3-11L	1SFA611102R1104	2/18
MP3-11R	1SFA611102R1101	2/18
MP3-11W	1SFA611102R1105	2/18
MP3-11Y	1SFA611102R1103	2/18
MP3-20B	1SFA611102R2006	2/16
MP3-20G	1SFA611102R2002	2/16
MP3-20L	1SFA611102R2004	2/16
MP3-20R	1SFA611102R2001	2/16
MP3-20W	1SFA611102R2005	2/16
MP3-20Y	1SFA611102R2003	2/16
MP3-21C	1SFA611102R2108	2/18
MP3-21G	1SFA611102R2102	2/18
MP3-21L	1SFA611102R2104	2/18
MP3-21R	1SFA611102R2101	2/18
MP3-21W	1SFA611102R2105	2/18
MP3-21Y	1SFA611102R2103	2/18
MP3-30B	1SFA611102R3006	2/16
MP3-30C	1SFA611102R3008	2/16
MP3-30G	1SFA611102R3002	2/16
MP3-30L	1SFA611102R3004	2/16
MP3-30R	1SFA611102R3001	2/16
MP3-30W	1SFA611102R3005	2/16
MP3-30Y	1SFA611102R3003	2/16
MP3-31C	1SFA611102R3108	2/18
MP3-31G	1SFA611102R3102	2/18
MP3-31L	1SFA611102R3104	2/18
MP3-31R	1SFA611102R3101	2/18
MP3-31W	1SFA611102R3105	2/18
MP3-31Y	1SFA611102R3103	2/18
MP4-10B	1SFA611103R1006	2/16
MP4-10C	1SFA611103R1008	2/16
MP4-10G	1SFA611103R1002	2/16
MP4-10L	1SFA611103R1004	2/16
MP4-10R	1SFA611103R1001	2/16
MP4-10W	1SFA611103R1005	2/16
MP4-10Y	1SFA611103R1003	2/16
MP4-11C	1SFA611103R1108	2/18
MP4-11G	1SFA611103R1102	2/18
MP4-11L	1SFA611103R1104	2/18
MP4-11R	1SFA611103R1101	2/18
MP4-11W	1SFA611103R1105	2/18
MP4-11Y	1SFA611103R1103	2/18
MP4-20G	1SFA611103R2002	2/16
MP4-20L	1SFA611103R2004	2/16
MP4-20R	1SFA611103R2001	2/16
MP4-20Y	1SFA611103R2003	2/16
MP4-21C	1SFA611103R2108	2/18
MP4-21G	1SFA611103R2102	2/18
MP4-21L	1SFA611103R2104	2/18
MP4-21R	1SFA611103R2101	2/18
MP4-21W	1SFA611103R2105	2/18
MP4-21Y	1SFA611103R2103	2/18
MP4-30B	1SFA611103R3006	2/16
MP4-30G	1SFA611103R3002	2/16
MP4-31C	1SFA611103R3108	2/18
MP4-31G	1SFA611103R3102	2/18
MP4-31L	1SFA611103R3104	2/18
MP4-31R	1SFA611103R3101	2/18
MPD1-11B	1SFA611130R1106	2/19
MPD1-11C	1SFA611130R1108	2/20
MPD1-11G	1SFA611130R1102	2/20
MPD1-11R	1SFA611130R1101	2/20
MPD1-11Y	1SFA611130R1103	2/20
MPD12-11B	1SFA611141R1106	2/19
MPD12-11C	1SFA611141R1108	2/21
MPD12-11G	1SFA611141R1102	2/21
MPD12-11R	1SFA611141R1101	2/21
MPD12-11Y	1SFA611141R1103	2/21
MPD13-11B	1SFA611142R1106	2/19
MPD13-11C	1SFA611142R1108	2/21
MPD13-11G	1SFA611142R1102	2/21
MPD13-11R	1SFA611142R1101	2/21
MPD13-11Y	1SFA611142R1103	2/21
MPD14-11B	1SFA611143R1106	2/19
MPD14-11C	1SFA611143R1108	2/21
MPD14-11G	1SFA611143R1102	2/21
MPD14-11R	1SFA611143R1101	2/21
MPD14-11Y	1SFA611143R1103	2/21
MPD15-11B	1SFA611144R1106	2/19
MPD15-11C	1SFA611144R1108	2/21

Type	Order code	Page
MPD15-11G	1SFA611144R1102	2/21
MPD15-11R	1SFA611144R1101	2/21
MPD15-11Y	1SFA611144R1103	2/21
MPD16-11B	1SFA611145R1106	2/19
MPD16-11C	1SFA611145R1108	2/21
MPD16-11G	1SFA611145R1102	2/21
MPD16-11R	1SFA611145R1101	2/21
MPD16-11Y	1SFA611145R1103	2/21
MPD17-11B	1SFA611146R1106	2/19
MPD17-11C	1SFA611146R1108	2/21
MPD17-11G	1SFA611146R1102	2/21
MPD17-11Y	1SFA611146R1103	2/21
MPD18-11B	1SFA611147R1106	2/19
MPD19-11B	1SFA611148R1106	2/19
MPD19-11C	1SFA611148R1108	2/21
MPD19-11G	1SFA611148R1102	2/21
MPD2-11B	1SFA611131R1106	2/19
MPD2-11C	1SFA611131R1108	2/20
MPD2-11G	1SFA611131R1102	2/20
MPD2-11R	1SFA611131R1101	2/20
MPD2-11Y	1SFA611131R1103	2/20
MPD3-11B	1SFA611132R1106	2/19
MPD3-11C	1SFA611132R1108	2/20
MPD3-11G	1SFA611132R1102	2/20
MPD3-11R	1SFA611132R1101	2/20
MPD3-11Y	1SFA611132R1103	2/20
MPD4-11B	1SFA611133R1106	2/19
MPD4-11C	1SFA611133R1108	2/20
MPD4-11G	1SFA611133R1102	2/20
MPD4-11R	1SFA611133R1101	2/20
MPD4-11Y	1SFA611133R1103	2/20
MPD5-11B	1SFA611134R1106	2/19
MPD5-11C	1SFA611134R1108	2/20
MPD5-11G	1SFA611134R1102	2/20
MPD5-11R	1SFA611134R1101	2/20
MPD5-11Y	1SFA611134R1103	2/20
MPD6-11B	1SFA611135R1106	2/19
MPD6-11C	1SFA611135R1108	2/20
MPD6-11G	1SFA611135R1102	2/20
MPD7-11B	1SFA611136R1106	2/19
MPD7-11G	1SFA611136R1102	2/20
MPD8-11B	1SFA611137R1106	2/19
MPD8-11C	1SFA611137R1108	2/20
MPD8-11G	1SFA611137R1102	2/20
MPD9-11B	1SFA611138R1106	2/19
MPEK3-11B	1SFA611522R1106	2/24
MPEK3-11R	1SFA611522R1101	2/23
MPEK3-12R	1SFA611522R1201	2/23
MPEK3-13R	1SFA611522R1301	2/23
MPEK4-11B	1SFA611525R1106	2/24
MPEK4-11R	1SFA611525R1101	2/23
MPEK4-12R	1SFA611525R1201	2/23
MPEK4-13R	1SFA611525R1301	2/23
MPEP3-10B	1SFA611521R1006	2/24
MPEP3-10R	1SFA611521R1001	2/23
MPEP4-10B	1SFA611524R1006	2/24
MPEP4-10R	1SFA611524R1001	2/23
MPET3-10B	1SFA611520R1006	2/24
MPET3-10R	1SFA611520R1001	2/23
MPET4-10B	1SFA611523R1006	2/24
MPET4-10R	1SFA611523R1001	2/23
MPM1-10B	1SFA611124R1006	2/22
MPM1-10G	1SFA611124R1002	2/22
MPM1-10R	1SFA611124R1001	2/22
MPM1-10Y	1SFA611124R1003	2/22
MPM1-11G	1SFA611124R1102	2/22
MPM1-11R	1SFA611124R1101	2/22
MPM1-11Y	1SFA611124R1103	2/22
MPM2-10B	1SFA611125R1006	2/22
MPM2-10R	1SFA611125R1001	2/22
MPM2-10Y	1SFA611125R1003	2/22
MPM2-11R	1SFA611125R1101	2/22
MPM2-11Y	1SFA611125R1103	2/22
MPMP3-11R	1SFA611511R1101	2/23
MPMP4-10R	1SFA611514R1001	2/23
MPMP4-11R	1SFA611514R1101	2/23
MPMT3-11R	1SFA611510R1101	2/23
MPMT4-10R	1SFA611513R1001	2/23
MPMT4-11R	1SFA611513R1101	2/23
MT-105B	1SFA611410R1056	2/38
MT-110B	1SFA611410R1106	2/38
MT-150B	1SFA611410R1506	2/38
MT-1B	1SFA611410R1006	2/38
MT-205B	1SFA611410R2056	2/38

Type	Order code	Page
MT-210B	1SFA611410R2106	2/38
MT-250B	1SFA611410R2506	2/38
MT-305B	1SFA611410R3056	2/38
MT-310B	1SFA611410R3106	2/38
MT-350B	1SFA611410R3506	2/38
MT-3B	1SFA611410R3006	2/38
MTS1-10B	1SFA611300R1006	2/42
MTS1-20B	1SFA611300R2006	2/42
MTS1-30B	1SFA611300R3006	2/42
MTS2-10B	1SFA611301R1006	2/42
MTS2-20B	1SFA611301R2006	2/42
MTS2-30B	1SFA611301R3006	2/42
MTS3-10B	1SFA611302R1006	2/42
MTS3-20B	1SFA611302R2006	2/42
MTS3-30B	1SFA611302R3006	2/42
P9ACA6	1SFA188804R8000	3/80
P9ACDPP	1SFA187843R8000	3/56
P9ACDDP	1SFA187843R8000	3/58
P9ACDPP	1SFA187843R8000	3/80
P9ACFS3	1SFA187841R8000	3/76
P9ACFS5	1SFA187842R8000	3/76
P9ACRCL	1SFA187840R8000	3/80
P9ACWAF	1SFA187845R8000	3/80
P9ARAM32	1SFA188801R8000	3/80
P9ARCST	1SFA187490R8000	3/80
P9ARSCMB	1SFA188044R8000	3/73
P9ARSCMN	1SFA188043R8000	3/73
P9ARSGMB	1SFA187496R8000	3/73
P9ARSGMN	1SFA187495R8000	3/73
P9B01FN	1SFA187012R8310	3/76
P9B01VN	1SFA187001R8010	3/76
P9B01VR	1SFA187003R8110	3/76
P9B02VN	1SFA187008R8020	3/76
P9B02VN-AA	1SFA205236R8020	3/76
P9B10FN	1SFA187013R8301	3/76
P9B10FN-AA	1SFA215835R8301	3/76
P9B10VA	1SFA187004R8201	3/76
P9B10VN	1SFA187002R8001	3/76
P9B10VN-AA	1SFA215832R8001	3/76
P9B11VN	1SFA187000R8011	3/76
P9B11VN-AA	1SFA242712R8011	3/76
P9B20VN	1SFA187009R8002	3/76
P9MCCB	1SFA184696R9006	3/74
P9MCC	1SFA184697R9006	3/74
P9MCD	1SFA184695R9006	3/74
P9MEC4RN01	1SFA192000R9001	3/59
P9MEC4RN37	1SFA192012R9001	3/59
P9MEC4RN95	1SFA184073R9001	3/59
P9MEM3GN	1SFA184033R9003	3/59
P9MEM3NN	1SFA184030R9006	3/59
P9MEM3RN	1SFA184031R9001	3/59
P9MEM3VN	1SFA184032R9002	3/59
P9MEM4GL	1SFA184553R9103	3/60
P9MEM4GN	1SFA184043R9003	3/59
P9MEM4LL	1SFA184556R9104	3/60
P9MEM4NN	1SFA184040R9006	3/59
P9MEM4RL	1SFA184551R9101	3/60
P9MEM4RN	1SFA184041R9001	3/59
P9MEM4VL	1SFA184552R9102	3/60
P9MEM4VN	1SFA184042R9002	3/59
P9MEM6GN	1SFA184053R9003	3/59
P9MEM6NN	1SFA184050R9006	3/59
P9MEM6RN	1SFA184051R9001	3/59
P9MEM6VN	1SFA184052R9002	3/59
P9MER3RN	1SFA184070R9001	3/59
P9MER4RN	1SFA184071R9001	3/59
P9MET4GL1	1SFA184563R9103	3/60
P9MET4GN1	1SFA184063R9003	3/59
P9MET4LL1	1SFA184566R9104	3/60
P9MET4NN1	1SFA184060R9006	3/59
P9MET4RL1	1SFA184561R9101	3/60
P9MET4RN1	1SFA184061R9001	3/59
P9MET4VL1	1SFA184562R9102	3/60
P9MET4VN1	1SFA184062R9002	3/59
P9MLAD	1SFA184795R9009	3/61
P9MLBD	1SFA184797R9005	3/61
P9MLGD	1SFA184793R9003	3/61
P9MLID	1SFA184798R9008	3/61
P9MLLD	1SFA184796R9004	3/61
P9MLRD	1SFA184791R9001	3/61
P9MLVD	1SFA184792R9002	3/61
P9MMB2A	1SFA184712R9006	3/72
P9MMB2F	1SFA184710R9006	3/72
P9MMB2FG	1SFA184709R9006	3/72

Index

Type classification

Type	Order code	Page	Type	Order code	Page	Type	Order code	Page
P9MMB2T	1SFA184711R9006	3/72	P9MSCD5A37	1SFA192252R9006	3/68	P9MSV10N	1SFA184371R9006	3/62
P9MMB4F	1SFA184740R9006	3/72	P9MSCD5A95	1SFA184409R9006	3/68	P9MSV15N	1SFA184374R9006	3/62
P9MMB4T	1SFA184741R9006	3/72	P9MSCI0C01	1SFA192150R9006	3/68	P9MSVX0N	1SFA184392R9006	3/66
P9MMB4TG	1SFA184744R9006	3/72	P9MSCI0C37	1SFA192162R9006	3/68	P9MSVX5N	1SFA184393R9006	3/66
P9MMN2A	1SFA184702R9006	3/72	P9MSCI0C95	1SFA184403R9006	3/68	P9MSVZ0N	1SFA184379R9006	3/64
P9MMN2B	1SFA184703R9006	3/72	P9MSCI0E01	1SFA192165R9006	3/68	P9MSVZ1N	1SFA184383R9006	3/64
P9MMN2F	1SFA184700R9006	3/72	P9MSCI0E95	1SFA184404R9006	3/68	P9MSVZ3N	1SFA184391R9006	3/64
P9MMN2T	1SFA184701R9006	3/72	P9MSCI0N95	1SFA184405R9006	3/68	P9MSVZ5N	1SFA184387R9006	3/64
P9MMN4F	1SFA184720R9006	3/72	P9MSCI5C01	1SFA192255R9006	3/68	P9PDNFO	1SFA187055R1300	3/77
P9MMN4T	1SFA184721R9006	3/72	P9MSCI5C37	1SFA192267R9006	3/68	P9PDNFO-AA	1SFA215834R1300	3/77
P9MMN4TG	1SFA184716R9006	3/72	P9MSCI5C95	1SFA184410R9006	3/68	P9PDNVO	1SFA187020R1080	3/77
P9MPLAGD	1SFA184495R9109	3/58	P9MSCX0A95	1SFA184468R9006	3/71	P9PDNVO-AA	1SFA215831R1000	3/77
P9MPLASD	1SFA184505R9109	3/58	P9MSCX0Z01	1SFA193335R9006	3/71	P9PDTVO	1SFA187027R8000	3/77
P9MPLBGD	1SFA184497R9105	3/58	P9MSCX0Z95	1SFA184482R9006	3/71	P9PLFVDA	1SFA197018R1019	3/79
P9MPLBGV	1SFA184527R9105	3/58	P9MSCZ0A95	1SFA184433R9006	3/69	P9PLFVDB	1SFA197019R1015	3/79
P9MPLBSD	1SFA184507R9105	3/58	P9MSCZ0C95	1SFA184434R9006	3/69	P9PLFVDG	1SFA197020R1013	3/79
P9MPLGGD	1SFA184493R9103	3/58	P9MSCZ0H95	1SFA184436R9006	3/69	P9PLFVDL	1SFA197021R1014	3/79
P9MPLGGV	1SFA184523R9103	3/58	P9MSCZ0N95	1SFA184438R9006	3/69	P9PLFVDR	1SFA197022R1011	3/79
P9MPLGSD	1SFA184503R9103	3/58	P9MSCZ0T01	1SFA192690R9006	3/69	P9PLFVDV	1SFA197023R1012	3/79
P9MPLIGD	1SFA184498R9108	3/58	P9MSCZ0T37	1SFA192702R9006	3/69	P9PLFVJB	1SFA197025R1045	3/79
P9MPLLGD	1SFA184496R9104	3/58	P9MSCZ0T95	1SFA184439R9006	3/69	P9PLFVJG	1SFA197026R1043	3/79
P9MPLLGV	1SFA184526R9104	3/58	P9MSCZ1C95	1SFA184449R9006	3/69	P9PLFVJR	1SFA197028R1041	3/79
P9MPLLLSD	1SFA184506R9104	3/58	P9MSCZ1N95	1SFA184451R9006	3/69	P9PLFVNB	1SFA197031R1075	3/79
P9MPLRGD	1SFA184491R9101	3/58	P9MSCZ3C01	1SFA193110R9006	3/70	P9PLFVNG	1SFA197032R1073	3/79
P9MPLRGV	1SFA184521R9101	3/58	P9MSCZ3C95	1SFA184467R9006	3/70	P9PLFVNR	1SFA197034R1071	3/79
P9MPLRSD	1SFA184501R9101	3/58	P9MSCZ5A01	1SFA193020R9006	3/70	P9PLNVDB	1SFA197001R1015	3/79
P9MPLVGD	1SFA184492R9102	3/58	P9MSCZ5A95	1SFA184461R9006	3/70	P9PLNVDG	1SFA197002R1013	3/79
P9MPLVGV	1SFA184522R9102	3/58	P9MSCZ5C95	1SFA184462R9006	3/70	P9PLNVDL	1SFA197003R1014	3/79
P9MPLVSD	1SFA184502R9102	3/58	P9MSCZ5H01	1SFA193050R9006	3/70	P9PLNVDR	1SFA197004R1011	3/79
P9MPNBG	1SFA184007R9005	3/56	P9MSCZ5H95	1SFA184463R9006	3/70	P9PLNVDV	1SFA197005R1012	3/79
P9MPNBG006	1SFA187152R9505	3/57	P9MSLD0A	1SFA184595R9109	3/63	P9PLNVJB	1SFA197007R1045	3/79
P9MPNBG028	1SFA187151R9505	3/57	P9MSLD0B	1SFA184597R9105	3/63	P9PLNVJG	1SFA197008R1043	3/79
P9MPNBG030	1SFA188057R9505	3/57	P9MSLD0G	1SFA184593R9103	3/63	P9PLNVJL	1SFA197009R1044	3/79
P9MPNBS	1SFA184017R9005	3/56	P9MSLD0I	1SFA184598R9108	3/63	P9PLNVJR	1SFA197010R1041	3/79
P9MPNGG	1SFA184003R9003	3/56	P9MSLD0L	1SFA184596R9104	3/63	P9PLNVJV	1SFA197011R1042	3/79
P9MPNGS	1SFA184057R9003	3/56	P9MSLD0R	1SFA184591R9101	3/63	P9PLNVNB	1SFA197013R1075	3/79
P9MPNHG	1SFA184008R9007	3/56	P9MSLD0V	1SFA184592R9102	3/63	P9PLNVNG	1SFA197014R1073	3/79
P9MPNLG	1SFA184006R9004	3/56	P9MSLZ0A	1SFA184605R9109	3/65	P9PLNVNL	1SFA197015R1074	3/79
P9MPNLG007	1SFA188900R9504	3/57	P9MSLZ0B	1SFA184607R9105	3/65	P9PLNVNR	1SFA197016R1071	3/79
P9MPNLG037	1SFA187143R9504	3/57	P9MSLZ0G	1SFA184603R9103	3/65	P9PLNVNV	1SFA197017R1072	3/79
P9MPNLS	1SFA184016R9004	3/56	P9MSLZ0L	1SFA184606R9104	3/65			
P9MPNNG	1SFA184000R9006	3/56	P9MSLZ0R	1SFA184601R9101	3/65			
P9MPNNG002	1SFA187139R9506	3/57	P9MSLZ0V	1SFA184602R9102	3/65			
P9MPNNG006	1SFA187117R9506	3/57	P9MSLZ1B	1SFA184617R9105	3/65			
P9MPNNG028	1SFA187111R9506	3/57	P9MSLZ1G	1SFA184613R9103	3/65			
P9MPNNG029	1SFA187150R9506	3/57	P9MSLZ1L	1SFA184616R9104	3/65			
P9MPNNG030	1SFA187145R9506	3/57	P9MSLZ1R	1SFA184611R9101	3/65			
P9MPNNG085	1SFA188886R9506	3/57	P9MSLZ1V	1SFA184612R9102	3/65			
P9MPNNG201	1SFA188908R9506	3/57	P9MSLZ3A	1SFA184635R9109	3/65			
P9MPNNS	1SFA184010R9006	3/56	P9MSLZ3B	1SFA184637R9105	3/65			
P9MPNNS029	1SFA187250R9506	3/57	P9MSLZ3G	1SFA184633R9103	3/65			
P9MPNNS032	1SFA187235R9506	3/57	P9MSLZ3I	1SFA184638R9108	3/65			
P9MPNRG	1SFA184001R9001	3/56	P9MSLZ3L	1SFA184636R9104	3/65			
P9MPNRG029	1SFA187110R9501	3/57	P9MSLZ3R	1SFA184631R9101	3/65			
P9MPNRG201	1SFA187147R9501	3/57	P9MSLZ3V	1SFA184632R9102	3/65			
P9MPNRS	1SFA184011R9001	3/56	P9MSLZ5I	1SFA184628R9108	3/65			
P9MPNRS029	1SFA187210R9501	3/57	P9MSLZ5L	1SFA184626R9104	3/65			
P9MPNVG	1SFA184002R9002	3/56	P9MSLZ5R	1SFA184621R9101	3/65			
P9MPNVG006	1SFA187118R9502	3/57	P9MSLZ5V	1SFA184622R9102	3/65			
P9MPNVG028	1SFA187112R9502	3/57	P9MSMD0N	1SFA184110R9006	3/62			
P9MPNVG030	1SFA187146R9502	3/57	P9MSMD0R	1SFA184111R9001	3/62			
P9MPNVG202	1SFA187149R9502	3/57	P9MSMD5G	1SFA184143R9003	3/62			
P9MPNVS	1SFA184012R9002	3/56	P9MSMD5N	1SFA184140R9006	3/62			
P9MPS22G	1SFA184691R9006	3/75	P9MSMD5R	1SFA184141R9001	3/62			
P9MPS34G	1SFA184693R9006	3/75	P9MSMI0G	1SFA184123R9003	3/62			
P9MSAD0B	1SFA184647R9105	3/63	P9MSMI0N	1SFA184120R9006	3/62			
P9MSAD0L	1SFA184646R9104	3/63	P9MSMI5N	1SFA184150R9006	3/62			
P9MSAD0R	1SFA184641R9101	3/63	P9MSMI5R	1SFA184151R9001	3/62			
P9MSAD0V	1SFA184642R9102	3/63	P9MSMI5V	1SFA184152R9002	3/62			
P9MSAZ0B	1SFA184657R9105	3/65	P9MSMW0N	1SFA184360R9006	3/66			
P9MSAZ0V	1SFA184652R9102	3/65	P9MSMX0N	1SFA184397R9006	3/66			
P9MSAZ3A	1SFA184685R9109	3/65	P9MSMX5N	1SFA184340R9006	3/66			
P9MSAZ3B	1SFA184687R9105	3/65	P9MSMY0N	1SFA184350R9006	3/67			
P9MSAZ3V	1SFA184682R9102	3/65	P9MSMY0R	1SFA184351R9001	3/67			
P9MSCD0A01	1SFA192105R9006	3/68	P9MSMZ0R	1SFA184200R9006	3/64			
P9MSCD0A37	1SFA192117R9006	3/68	P9MSMZ0N	1SFA184201R9001	3/64			
P9MSCD0A95	1SFA184400R9006	3/68	P9MSMZ1N	1SFA184240R9006	3/64			
P9MSCD0E01	1SFA192120R9006	3/68	P9MSMZ1R	1SFA184241R9001	3/64			
P9MSCD0E95	1SFA184401R9006	3/68	P9MSMZ3N	1SFA184320R9006	3/64			
P9MSCD0K01	1SFA192135R9006	3/68	P9MSMZ3R	1SFA184321R9001	3/64			
P9MSCD0K37	1SFA192147R9006	3/68	P9MSMZ5N	1SFA184280R9006	3/64			
P9MSCD0K95	1SFA184402R9006	3/68	P9MSVD0	1SFA184822R9003	3/62			
P9MSCD5A01	1SFA192240R9006	3/68	P9MSVD0N	1SFA184370R9006	3/62			
P9MSCD5A33	1SFA192250R9006	3/68	P9MSVD5N	1SFA184373R9006	3/62			

Marketing materials

Videos

Watch our videos to learn more about our product range



ABB Pilot devices manufacturing



Modular range assembly

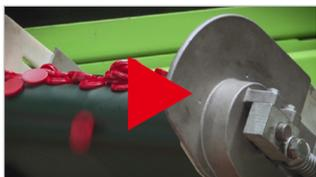

IPX6 water spray test



IPX7 submersion test



Catalogs

Find our catalogs on the web



Complete offering
Catalog number: 1SFC151007C0201

Data sheet

For direct product details information, use product type or order code

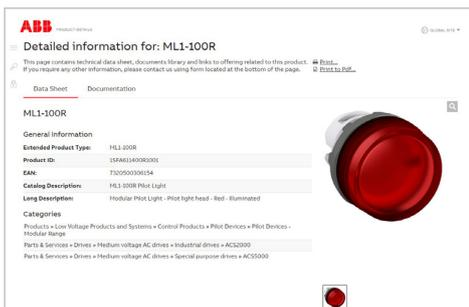

<http://new.abb.com/products/> **product type or order code**

Ex: <http://new.abb.com/products/ML1-100R>
<http://new.abb.com/products/1SFA611400R1001>

3D models

Download and view our products in 2D or 3D (STEP, IGES, ...) with Cadenas 3D-models

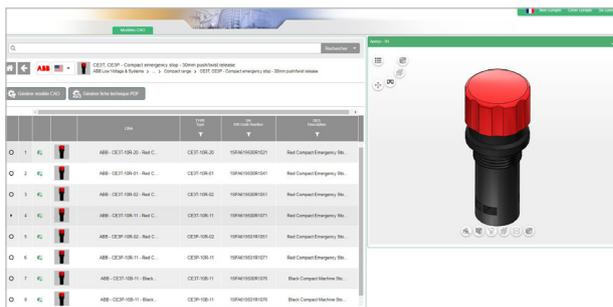

<http://abb-control-products.partcommunity.com/3d-cad-models/>



ABB AB

Electification Sweden AB

Smart Power Division

Motorgränd 20

SE-721 61 Västerås / Sweden

You can find the address of your local sales organisation on the ABB home page.



<http://new.abb.com/low-voltage/products/pilot-devices>



<http://www.abb.com/lowvoltage>

We reserve the right to make technical changes or modify the contents of this document without prior notice. ABB does not accept any responsibility whatsoever for potential errors or possible lack of information in this document.

We reserve all rights in this document and in the subject matter and illustrations contained therein. Any reproduction, disclosure to third parties or utilization of its contents – in whole or in parts – is forbidden without prior written consent of ABB.

Copyright© 2021 ABB - All rights reserved