

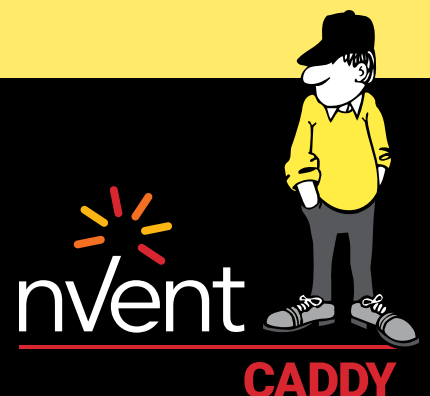

CONNECT AND PROTECT

Fixing, Fastening, and Support Products

Complete Product Offering - Europe





Just as every idea begins with a spark, we at nVent view the dawn of every sunrise as a new opportunity to ignite innovation. Our inventive solutions benefit customers around the world every day, keeping lights on, data streaming and trains running on time.

From heat trace cables to critical equipment enclosures to labor-efficient fastening systems, we empower customers to improve performance, lower costs and reduce downtime.

We are a \$2.1 billion, high-performance electrical company with a dedicated team of 9,000 people and trusted brands such as CADDY, ERICO, HOFFMAN, RAYCHEM, SCHROFF and TRACER. Known for innovation, quality and reliability, our products connect and protect, consistently delivering value to industrial, commercial, residential, energy and infrastructure customers.

While our name may be new, our products have set the standards for quality for more than a century. Today as nVent, we are focused and forward-looking, ready to build upon our legacy. The future is now.

At nVent, we believe that safer systems ensure a more secure world. We connect and protect our customers with inventive electrical solutions.

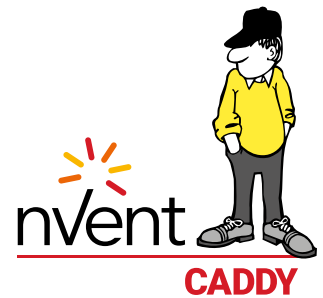

Table of Contents

INTRODUCTION

Featured Products	A-1
Product Application reference	B-1
Product Picture Reference	C-1

CABLE CONDUIT

Beam	1-2
Deck	1-16
Purlin	1-16
Rod/Wire	1-17
Clamps and Clips	1-19
Cable Tray and Accessories	1-27

CEILING/ACOUSTICAL

Adjustable Box Components and Conduit Supports	2-2
Chain and Hooks	2-3
Independent Support Clip	2-5
T-Grid Twist Clips	2-5

STUD WALL

Stud Mounted Box Brackets	3-2
Stud Mounted Switch Box Brackets	3-2
Cable/Conduit to Stud	3-2
Screw Gun Brackets and Accessories	3-4
Through Stud Cable/Conduit Supports	3-5

DATACOM/LOW VOLTAGE

Cable Support Systems	
nVent CADDY Cat HP J-Hook System	4-2
nVent CADDY Cat CM Cable Support System	4-17
nVent CADDY Cat 425 Adjustable Cable Supports	4-17
Bridle Rings	4-18
Clips, Clamps and Retainers	4-19

STRUCTURAL ATTACHMENTS

Beam/Purlin	5-2
Deck	5-19
Wall/Ceiling	5-24
Rod/Wire	5-26
Fasteners/Hardware	5-31
Anchors	5-43

NVENT CADDY ROD LOCK THREADED ROD MOUNTING SYSTEM

Rod Lock Structural Attachments	6-5
Rod Lock Supports	6-8
Rod Lock Hardware	6-10

NVENT CADDY SPEED LINK UNIVERSAL SUPPORT SYSTEM

Speed Link Catenary System	7-5
Speed Link SLK System	7-9
Speed Link SLS System	7-21
Speed Link LD System	7-26
Speed Link SLDM System	7-26
Speed Link Extensions	7-27
Speed Link Locking Devices and Wire Rope	7-29
Speed Link Accessories	7-32

NVENT CADDY PYRAMID ROOFTOP SYSTEMS

Pyramid ST Strut-Based Supports	8-4
Pyramid RL Roller-Based Supports	8-6
Pyramid H-Frame	8-8
Pyramid Equipment Supports	8-9
Pyramid EZ Rubber-Based Support	8-13
Pyramid Universal Support	8-13
Pyramid Tool-Free Supports	8-14
Pyramid 25 Pipe and Conduit Support, Plastic	8-16

MECHANICAL

Clevis Hangers	9-2
Loop Hangers	9-4
Rubber Lined Pipe Clamps	9-9
Pipe Clamps	9-20
Pipe/Tube to Strut	9-31
Pipe Fixings	9-33
Pipe Expansion Products	9-40
Radiator Fixings	9-44
Pipe Insulation Products	9-45
Ventilation	9-47
Sign and Name Plate Systems	9-52
Sound and Vibration Insulators	9-56

BRACING SYSTEMS

Rigid Bracing	10-4
Cable Bracing	10-16
Branch Line Restraint System	10-20
Rod Stiffeners	10-22

METAL FRAMING

ERISTRUT Strut Channel System	11-2
C-Channel System	11-41
U-Channel System	11-56
Telescoping Support Brackets	11-59
Support Kits	11-60
Sound Insulation	11-61
Wall Brackets	11-62

TECHNICAL INFORMATION

Materials & Finishes	D-2
Pipe Hanger & Support Recommended Specifications	D-4
nVent CADDY ERISTRUT Load Applications	D-14

All dimensions are $\pm 5\%$. Product designs and specifications are subject to change without notice.
For the most recent and updated information consult our website at nVent.com/CADDY

WARNING

nVent products shall be installed and used only as indicated in nVent's product instruction sheets and training materials. Instruction sheets are available at nVent.com/CADDY and from your nVent customer service representative. Improper installation, misuse, misapplication or other failure to completely follow nVent's instructions and warnings may cause product malfunction, property damage, serious bodily injury and death and/or void your warranty.

ANSI is a registered trademark of American National Standards Institute.

BeA is a registered trademark of Joh. Friedrich Behrens AG

Dyna-Flow is a registered trademark of Allied Tube & Conduit Corporation.

FM is a registered certification mark of FM Approvals LLC, LTD.

HILTI is a registered trademark of Hilti Aktiengesellschaft.

ISO is a registered trademark of International Organization for Standardization.

NEC is a registered trademark of, and National Electrical Code (NEC) standard is a copyright of the National Fire Protection Association, Inc.

NFPA is a registered trademark of National Fire Protection Association, Inc.

Powers is a registered trademark of Stanley Black & Decker.

Ramset is a registered trademark of Illinois Tool Works, Inc.

Simpson is a registered trademark of Simpson Strong-Tie Company Inc.

SPIT is a registered trademark of Societe De Prospection & D'Inventions Techniques Spit.

TORX is a registered trademark of Acument Intellectual Properties, LLC.

UL, UR, cUL, cUR, cULus and cURus are registered certification marks of UL LLC.

VdS is a registered trademark of VdS Schadenverhütung GmbH.

Xenoy is a registered trademark of Sabic Innovative Plastics IP B.V

Featured products



Featured products

NVENT CADDY ROD LOCK

– See Page 6-5 –



The Rod Lock family of products allows contractors to prefabricate complex assemblies at ground level or offsite, and then easily lift and lock them into place by pushing the threaded rod supports into the Rod Lock device. This ingenious technology works with threaded rod with burrs or imperfections, helping to eliminate clean-up time or the need to replace damaged threaded rod.

The most unique feature of the system is its breakthrough "push-to-install" design, which dramatically reduces the installation time of threaded rod support structures when compared to conventional fasteners. Simply speaking – Rod Lock is revolutionizing how contractors support conduit, cable tray, lights, ductwork and pipe by helping to make installations faster, easier and more secure.

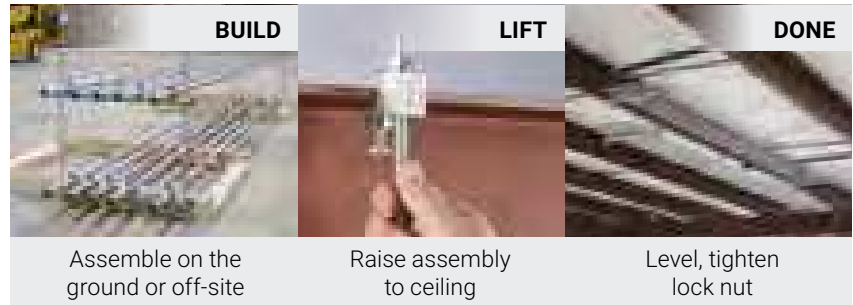
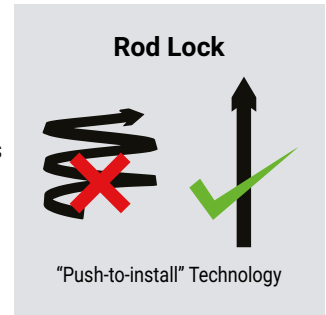

TELESCOPING SUPPORT BRACKETS

– See Page 6-9, 7-25, and 11-59 –



The Telescoping Strut Replacement is an innovative alternative to using traditional strut channels for trapeze or other support structures that accommodates standard strut fittings. This telescoping solution eliminates the need to handle and cut long lengths of strut to size. The bracket telescopes to the desired length and is locked in place by snapping closed a spring retainer clip.

- Standard strut profile runs the entire length of the part, allowing most standard fittings to be placed anywhere between the rods
- Spring steel retainer strap can be manually locked into place, allowing a tool-free installation
- Ready to use out of the box and eliminates the need for cutting sections of strut
- Pre-cut design is easier to transport and store than standard lengths of strut

Featured products

NVENT CADDY SPEED LINK CATENARY SYSTEM

– See Page 7-5 –



The nVent CADDY Speed Link Catenary System provides an easy- and fast-to-install fixing solution for commercial buildings where structural supports are far apart. This versatile solution, which can be installed on almost any type of structure, will also increase safety on the jobsite by limiting the amount of time spent on a lift doing repetitive and cumbersome tasks, keeping the number of tools down to a minimum and providing an easy-to-remove solution.

This range supports a wide range of datacom, electrical and mechanical applications, including cable trays, lights, signage and duct.

NVENT CADDY SPEED LINK SLK WITH DROP WIRE CLIP

– See Page 7-7 –

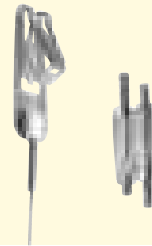

Complete system includes wire, locking device and pre-assembled spring steel end fitting to hang services from catenary cable.

NVENT CADDY SPEED LINK SLK SPOOL KIT WITH WIRE ROPE CUTTER

– See Page 7-29 –



- Includes two nVent CADDY Speed Link SLK Spool Kits with wire spools and locking devices and one wire rope cutter
- Wire spool and locking devices are packaged together, simplifying transportation to the jobsite and reducing inventory
- Packaging allows end-users to pull and cut any length of wire that is needed without having to take the spool out of the box

NVENT CADDY SPEED LINK SLK SYSTEM

– See Page 7-9 –

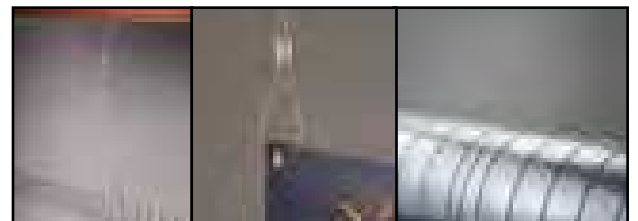

- Push/pull keyless release allows easy adjustments
- Range includes solutions for both 1.5 mm and 2 mm cables as well as larger 3 mm cables for higher load applications
- Low-profile locking device minimizes visual impact
- Cable spread of 90 degrees allows positioning the device closer to the load
- Keyless release tubes are easy to operate while wearing gloves
- Double-sided locking mechanism enables simple height adjustment
- Individual packaging holds wire rope neatly until objects are ready to install

Featured products

NVENT CADDY CAT HP CABLE SUPPORT SYSTEM

– See Page 4-2 –



The Cat HP J-Hook System is an advanced, non-continuous pathway support solution for today's high-performance cabling systems. Highly engineered features help ensure a stable and secure installation that complies with industry codes and standards for high-performance cables.

The Cat HP System is a cost-effective alternative to using wire mesh cable tray, ladder tray or similar complex alternatives. It requires significantly less material and installs in a fraction of the time of other methods. This versatile solution accommodates a wide range of attachment methods and is available as individual J-Hooks, pre-built Cat HP assemblies and multi-tiered trees, as well as interchangeable Cat HP components. The Cat HP J-Hook System provides the perfect combination of performance, time savings and versatility required by today's datacom and electrical contractors.

- Provides superior fill capacity and load rating over most other non-continuous cable support alternatives
- Offers a variety of attachment methods
- Uses up to 88% less material by weight than traditional cable tray methods

NVENT CADDY PYRAMID ROOFTOP SYSTEMS

– See Page 8-4 –



nVent CADDY Pyramid rooftop supports are a surface mounted solution for supporting electrical and mechanical applications on a variety of roof surfaces. They offer superior load capacity and dramatically reduce installation time by replacing slow, heavy and labor-intensive methods for support of pipe, conduit, duct, cable tray and equipment. Unlike wood blocks, nVent CADDY Pyramid supports are specifically designed for rooftop applications, incorporating unique materials and finishes that protect roof membranes and provide superior corrosion protection.

NVENT CADDY PYRAMID TOOL-FREE SUPPORTS

– See Page 8-14 –



- Push-in fasteners install without the need for additional tools or hardware
- Ready to use out of the box, saving installation time and labor
- Plastic fasteners and base will not corrode

Featured products

CABLE MANAGEMENT



UNIVERSAL TRAY SUPPORT



– See Page 1-29 –

- Universal design to accommodate various cable tray hanging methods including ceiling, wall, threaded rod, or cable hanging systems
- C-shape maintains accessibility to cables after installation is completed
- Strut profile on both arms allow for two runs of cable trays per bracket
- Top tab can be bent allowing for extra wide cable trays to be installed when two brackets are fastened back-to-back
- Key holes provided for wall mount applications
- Works with the KBT Wire Basket Tray Clip for securing wire basket cable tray or J-bolts for securing cable ladder

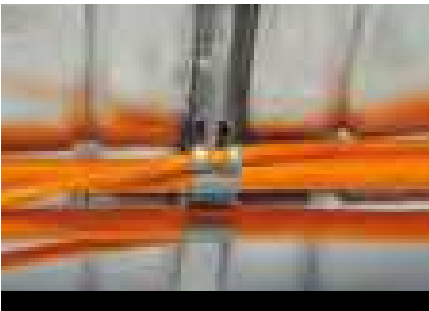

SCD MULTI-CABLE TO DECK CLIP

– See Page 1-16 –

- Provides support for low voltage cables
- Flared edges for cable protection
- Rotates 360 degrees to support various directional runs of cable
- No tools required for installation

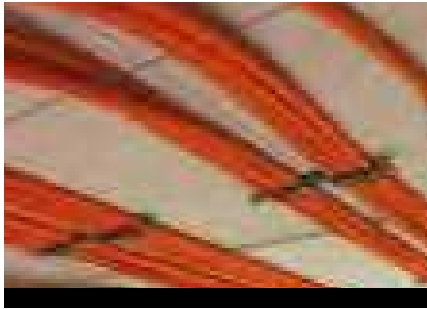

METAL PRESSURE CLIP, FIRE-RATED



– See Page 4-20 –

- Includes insert for E30 fire rating according to DIN 4102-12
- Ideal for smaller runs of cable
- Flexible clip retains shape and allows for cables to be inserted after installation
- Rounded edges help prevent cable damage
- Low-profile allows for installations in tight spaces

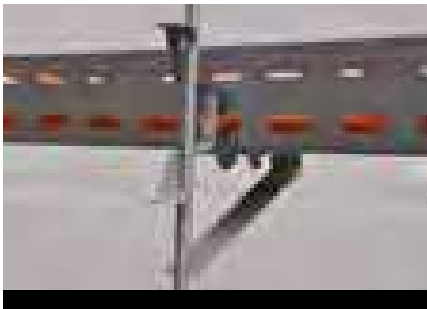

CABLE TRAY TO ROD CLIP

– See Page 1-28 –

- Supports cable tray up to 68 mm wide

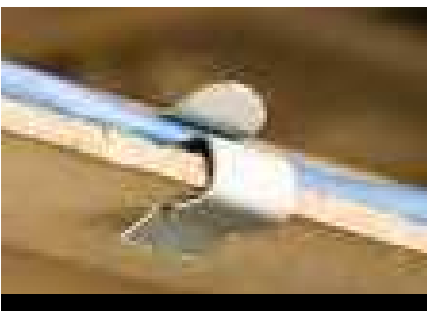

SC CABLE SNAP CLIP

– See Page 1-10 –

- Easily supports cable from flanges
- Requires only a hammer to install

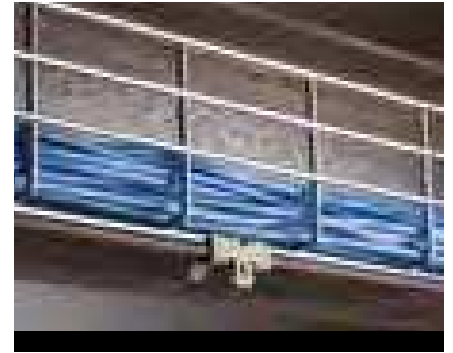

CABLE TRAY WITH FLANGE CLIP

– See Page 1-28 –

- Quick and easy solution to support datacom cables along existing I-beams
- Half the weight and is an alternative to traditional cable tray
- Utilizes the lost space within the beam, modifying it to a practical cable tray



CABLE TIE HOLDER WITH FLANGE CLIP

– See Page 1-12 –

- Used to support cables from beam flanges
- Requires only a hammer to install



WIRE BASKET TRAY CLIP

– See Page 1-27 –

- Attaches wire basket tray to strut without additional hardware
- No tools required

Featured products

STRUCTURAL ATTACHMENTS



HAMMER-ON FLANGE CLIP, SIDE MOUNT

– See Page 5-14 –

- Provides an attachment for wire, S-hooks, chain, Speed Link or other assemblies to flanges and profiles
- Fits most beams
- Installs with just a hammer



HAMMER-ON FLANGE CLIP, BOTTOM MOUNT WITH STUD

– See Page 5-13 –

- Can be used to support boxes, fixtures or other applications from beam flanges
- Captive threaded stud minimizes the need for additional hardware
- Assorted attachment points provided to reduce inventory
- Requires only a hammer to install



TDHM TRAPEZOIDAL DECK HANGER WITH FIXED NUT

– See Page 5-22 –

- Easy install
- Use TDHP perforation tool to punch hole in decking



- NEW - Flange Thickness: 21 - 28 mm



- NEW - Flange Thickness: 21 - 28 mm



NVENT CADDY ROD LOCK SPRING STEEL ROD HANGER TO FLANGE CLIP

– See Page 5-16 –

- Suspends threaded rod from beam flanges
- Threaded rod hanger can swivel to provide a vertical dropdown
- Requires only a hammer to install
- Easy “push-to-install” design allows installers to simply push the threaded rod through the mounting hole, instantly holding it in position
- Prefabricated assemblies easily lift and lock into place, helping to save time and money
- Works with slightly damaged threads and minor burrs on threaded rod ends
- Design includes a release mechanism that works with pliers

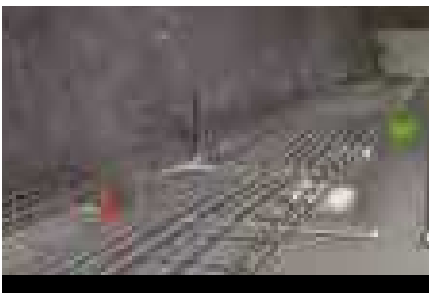

UBHT CONCRETE BEAM CLAMP WITH CANTILEVER ARM

– See Page 5-5 –

- Under beam attachment
- Rod extends past beam to support basket tray



VKR TRAPEZOIDAL DECK HANGER

– See Page 5-25 –

Featured products

CONCRETE SOLUTIONS



THREAD INSTALL ROD HANGER WITH NAIL GUN BRACKET

– See Page 5-28 –

- Suspends threaded rod without the need for additional hardware
- Complete with concrete nail gun insert bracket
- Clips onto nozzle of gas or battery-actuated nail guns allowing for hands-off installation at structure or from the floor using a pole
- Longer leg angle bracket for tool clearance
- Quickly and easily attaches to concrete, steel or composite metal decking



SPEED LINK SLK WITH WEDGE ANCHOR

– See Page 7-17 –

- Complete system includes wire, locking device and wedge anchor from Powers Fasteners, Inc.
- Quickly and easily attaches into cracked and non-cracked concrete
- No special tools required
- ETA-13/0106 approval available for wedge anchor from Powers Fasteners, Inc



PBF TWO HOLE BASE PLATE FOR THREADED ROD

– See Page 5-25 –

- Light duty with two holes and one nut/adaptor



CAT HP J-HOOK WITH NAIL GUN BRACKET

– See Page 4-8 –

- Provides optimal support for high-performance data cable, up to and including Cat 5e, Cat 6, Cat 6A, Cat 7 and fibre optic
- Complete with concrete nail gun insert bracket
- Clips onto nozzle of gas or battery-actuated nail guns allowing for hands-off installation at structure or from the floor using a pole
- Longer leg angle bracket for tool clearance
- Quickly and easily attaches to concrete, steel or composite metal decking
- Rounded edges on J-Hooks provide proper bend radius support for high performance data cables
- Provides superior fill capacity and load rating over most other non-continuous cable support alternatives
- Complies with EN 50174-2
- Meets ISO@/IEC 14763-2, ANSI@/TIA 568 and ANSI@/TIA 569



LIGHT DUTY PUSH-IN ANCHOR

– See Page 5-51 –



BSZ-SU CONCRETE SCREW

– See Page 5-44 –

- Fire resistance class R30-R120 for design of anchorages under exposure to fire
- ETA approved for anchoring in cracked and non-cracked concrete
- Approved for use in seismic design category C1 (for Drill Bit Diameters 8mm and greater)

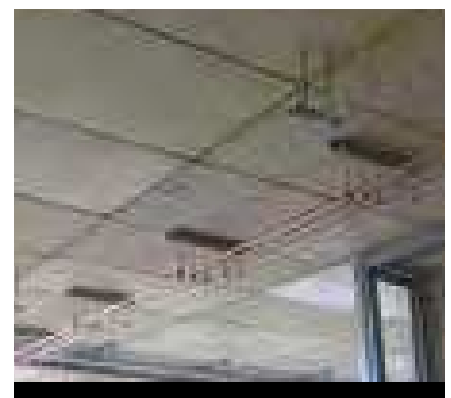

ROD LOCK ANCHOR SCREW

– See Page 6-6 –

- For use with concrete and solid brick
- Prefabricated assemblies easily lift and lock into place, helping to save time and money
- Works with slightly damaged threads and minor burrs on the threaded rod

Featured products

PIPE AND DUCT HANGERS



NVENT CADDY MACROFIX INSULATED VENTILATION DUCT CLAMP

– See Page 9-47 –

- Complete hanger assembly comes out of the box ready to install (sizes up to 600 mm)
- Increased opening angle easily accommodates all standard-sized spiral ducts (sizes up to 600 mm)
- Quick locking system prevents the hanger from accidentally opening when duct is moved or adjusted (sizes up to 600 mm)
- Quick locking system easily closes with one hand (sizes up to 600 mm)
- Thread impression retains quick locking captive screw and prevents it from falling out during installation
- Return-lip on the hanger prevents the rubber from detaching, eliminating rework during installation
- Combo head bolt works with slotted, hex, or Phillips drivers
- Longer ears position the screw farther from the hanger, improving tool clearance when the screw is tightened



NVENT CADDY MACROFIX INSULATED M8/M10

– See Page 9-10 –

- Return-lip on the hanger prevents the rubber from detaching, eliminating rework during installation
- Plastic washer prevents screws from falling out during installation
- Combo head bolt works with slotted, hex, or Phillips drivers
- Longer ears position the screw farther from the hanger, improving tool clearance when the screw is tightened
- Combination nut can be attached to M8 or M10 threaded rod, simplifying material handling



NVENT CADDY MACROFIX NON-INSULATED M8/M10

– See Page 9-25 –

- Plastic washer prevents screws from falling out during installation
- Combo head bolt works with slotted, hex, or Phillips drivers
- Longer ears position the screw farther from the hanger, improving tool clearance when the screw is tightened
- Combination nut can be attached to M8 or M10 threaded rod, simplifying material handling
- Screw length has been optimized to accommodate an increased pipe range, reducing inventory



FCS HEIGHT ADJUSTABLE LOOP HANGER

– See Page 9-6 –

- Recommended for the suspension of stationary non-insulated fire sprinkler pipe
- Redesigned strap and cup nut minimize friction for easier adjustment up and down the threaded rod (1/2" to 4" sizes)
- Formed tips on the upper strap simplify disassembly and reassembly of the hanger
- Rolled edges on the strap help to guide the pipe through, limiting binding and damage to metal or plastic pipe
- Package includes all necessary hardware for installation



HD HEAVY DUTY PIPE CLAMP

– See Page 9-17 –

- Fillet welded connector nut has flats to accommodate spanners
- Easy open flange for pipe sizes less than 4"
- Adaptor bushings to female 1/2", 3/4", 1" available
- Category II noise reduction according to DIN EN ISO 3822-1
- Compliant for sound insulation design according to DIN 4109
- Reaction-to-fire classification is "E" in compliance with DIN EN 13501-1:2010-01

Featured products

STRUT SOLUTIONS



ESC STRUT ATTACHMENT CLIP

- See Page 11-41 -
- Attaches to open side of a strut channel

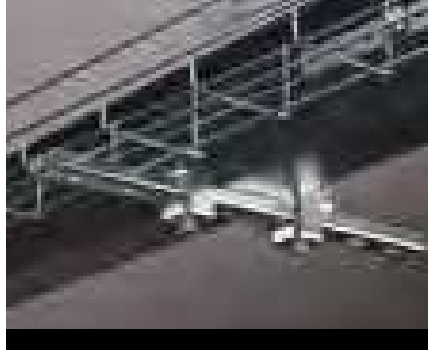

3000 BEAM CLAMP KIT

- See Page 5-6 -



6000 BEAM CLAMP KIT WITH SWIVEL

- See Page 5-8 -
- Strut channel system, complete kit with swivel adapter
- Beam clamps grip laterally over the channel preventing it from twisting



SN SERIES NUT

- See Page 6-10 -
- Reduces the need for threading compared to standard nuts and washers

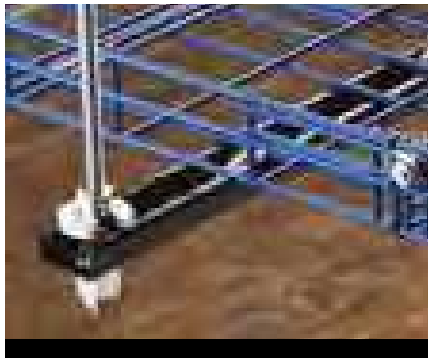

NWS FLANGED NUT

- See Page 6-11 -
- Use as a stopper when installing nVent CADDY Rod Lock assemblies
- Can be easily installed, removed, and repositioned at any location along the threaded rod



INC8 INTERNAL STRUT BEAM CLAMP

- See Page 11-32 -
- Mounts strut within beams

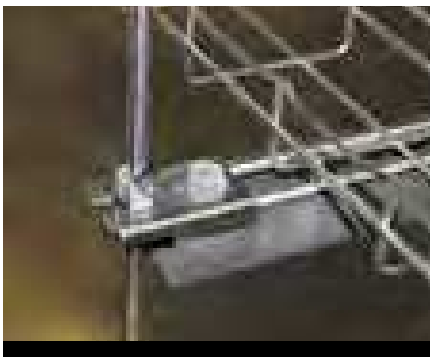

STRUT TRAPEZE ATTACHMENT PLATE

- See Page 11-38 -
- Creates fast install trapeze brackets
- Includes hex bolt and strut nut



QUICK STRUT NUT WITH STUD

- See Page 11-8 -
- Provides fast universal attachment of threaded rod and hardware to standard strut profiles

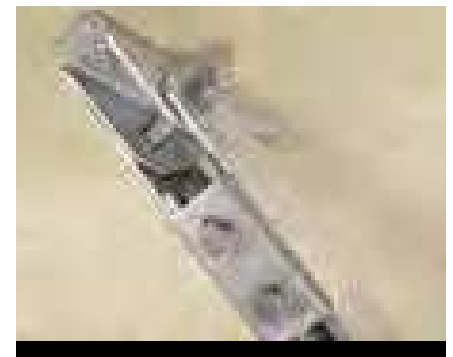

2-2 HOLE ADJUSTABLE STRUT SWIVEL BRACKET

- See Page 11-37 -
- Strut to strut applications for seismic bracing

Featured products

SEISMIC / MEP BRACING



RIGID BRACING

– See Page 10-4 –

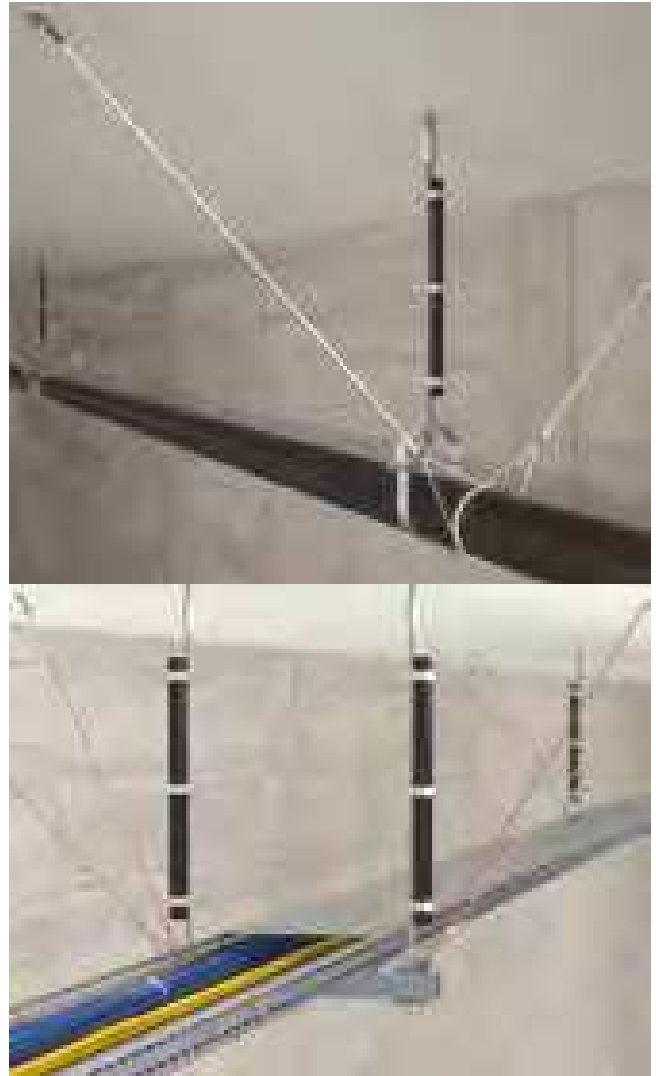

CABLE BRACING

– See Page 10-16 –



BRANCH LINE RESTRAINT SYSTEM

– See Page 10-20 –



ROD STIFFENERS

– See Page 10-22 –

Featured products

OTHER GOOD STUFF



NVENT CADDY SUPERFIX 243

– See Page 9-15 –

- Includes easy closing mechanism
- Category II noise reduction according to DIN EN ISO 3822-1
- Compliant for sound insulation design according to DIN 4109



TELESCOPING SCREW GUN BOX BRACKET

– See Page 3-4 –

- Can mount multiple boxes
- Notched and marked for easy identification and bending
- Improved design with stamped inch markings and pilot holes accelerates precise box conduit mounting between studs
- Pilot holes allow easy box attachment with a screwdriver
- Requires only a screw gun to install
- Adjustable for non-standard stud spacing
- Unique, one-piece, break apart design

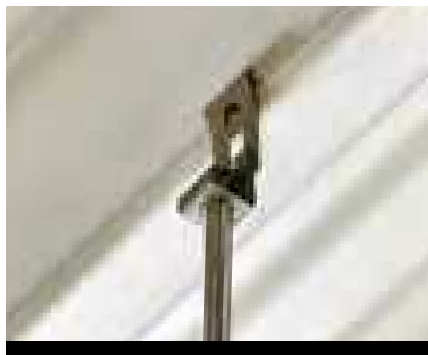

OCDC-TI/T DECK THREADED ROD HANGER

– See Page 5-23 –

- Suspends plain rod, threaded rod and wire drops from decking



H-MSS INLINE HAMMER-ON STRAP HANGER

– See Page 9-49 –

- Supports pipe or duct from flange with banding or strapping

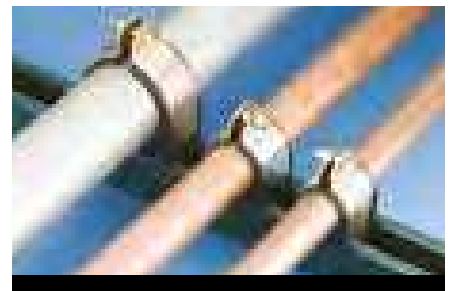

NVENT CADDY CUSHION CLAMP INSULATED STRUT CLAMP FOR PIPE/TUBE

– See Page 9-31 –

- Fits into open side of strut channel
- Plastic cushion is hinged to spread apart for easy installation
- Reduces noise and absorbs shock by gripping the pipe/tube firmly
- Square neck of carriage bolt prevents over-tightening
- Nylon locknut prevents loosening under vibration

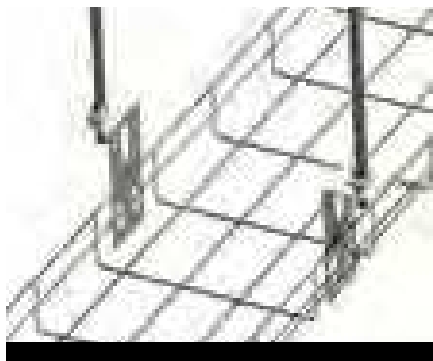

WIRE BASKET SUPPORT CLIP

– See Page 1-29 –

- Allows wire basket to be suspended from threaded rod without the need of a strut trapeze
- Securing fingers provides superior stability, preventing damage to the cables in the basket
- Allows for pre-fabrication off site



CONNECT AND PROTECT



Why Contractors Choose nVent CADDY Spring Steel Fasteners

Premium quality with superior corrosion protection - nVent CADDY is committed to earning the trust of contractors by providing the best solution—one that is simple, intuitive and helps to provide a lower total installed cost.

Unmatched innovation - The versatility of nVent CADDY products cover a range of assembly configurations and orientations with fewer parts. Our unique solutions are easy to use and offer flexibility to adapt to the needs of specific projects.

Breadth of offering - Contractors can count on a variety of reliable and innovative nVent CADDY solutions. nVent CADDY has developed industry leading solutions for many applications.

nVent.com/CADDY

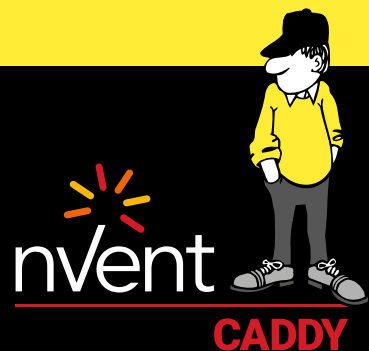

CADDY ERICO HOFFMAN RAYCHEM SCHROFF TRACER

Product Applications

CABLE MANAGEMENT - LARGE BUNDLE - CONTINUOUS / NON-CONTINUOUS



1-29, 5-44



1-29, 5-43



11-14, 11-7, 5-43



1-27



7-27



8-4, 8-5, 8-6



6-9, 1-27, 5-31



7-22

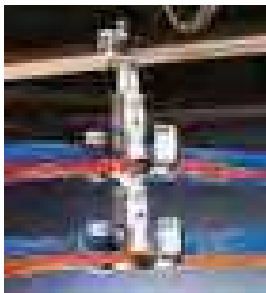

4-15

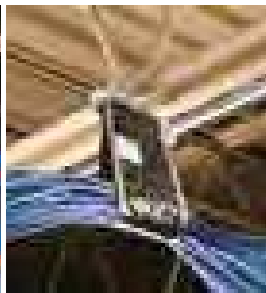

4-17

CABLE MANAGEMENT - MEDIUM BUNDLE

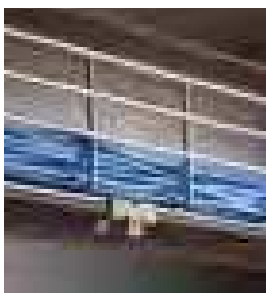

1-28



8-15

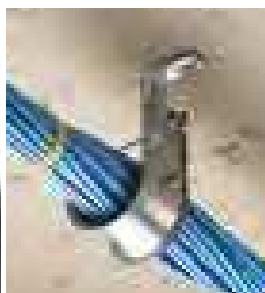

4-8



4-17

Product Applications

CABLE MANAGEMENT - MEDIUM BUNDLE



4-2, 4-13



4-2, 4-14, 5-31

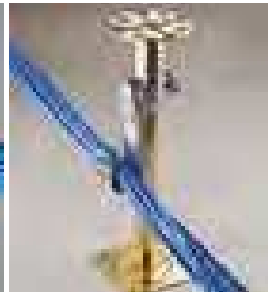

4-2, 4-14

CABLE MANAGEMENT - SMALL BUNDLE



4-7, 5-31



1-16



4-12, 4-2

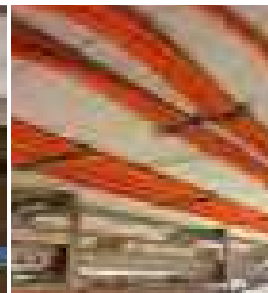

4-20, 4-21, 4-22

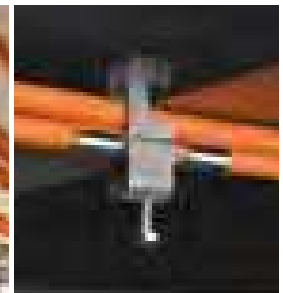

1-25



1-10, 1-11

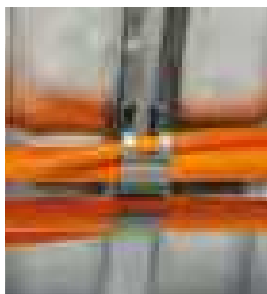

1-16



3-3

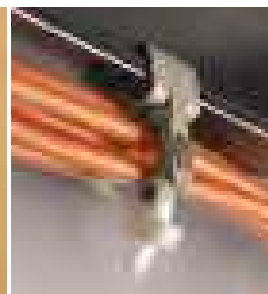

1-14

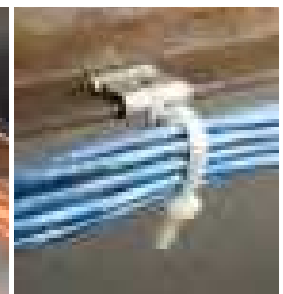

1-12

Product Applications

CABLE MANAGEMENT - SINGLE CABLE

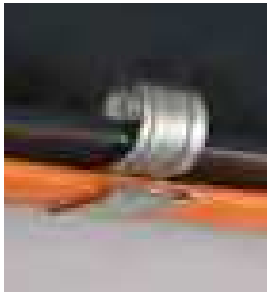

1-8



1-14

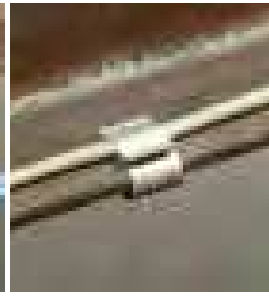

1-7



1-22, 1-24

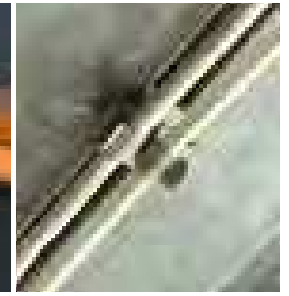

1-10, 1-11

STUDWALL



3-4, 3-5, 9-16, 11-45



3-4, 3-5, 9-12, 9-16, 11-45



3-4, 3-5, 9-16, 11-45

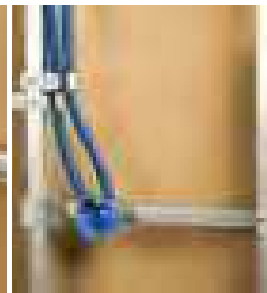

3-4, 3-5

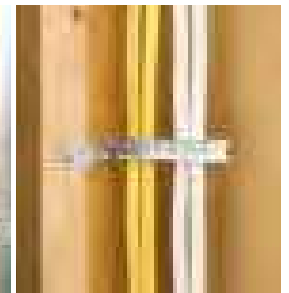

3-3



3-4, 3-5



3-4, 3-5

Product Applications

CONCRETE SOLUTIONS



6-6

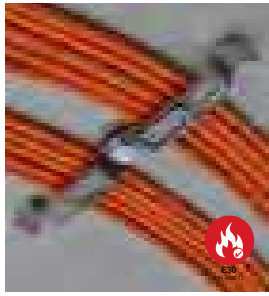

4-2, 5-44



7-17



5-25, 5-30, 9-11



5-45, 10-8, 10-10



5-28, 5-31



7-10



4-8



5-29



5-41



1-11, 1-10



1-16



5-24, 5-31



5-23, 5-31



5-23, 5-31



5-53

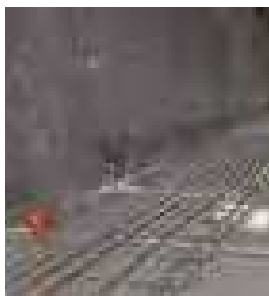

5-5



7-33, 7-22, 7-26



9-35



9-35

Product Applications

CEILING / ACOUSTICAL

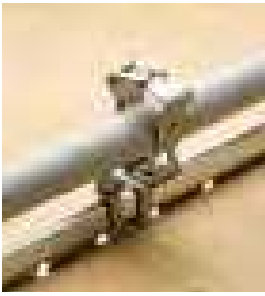

2-2



2-3



2-5, 7-26



2-5, 7-19



2-6



2-6, 7-26

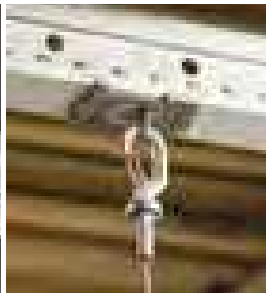

2-6, 7-14, 7-26

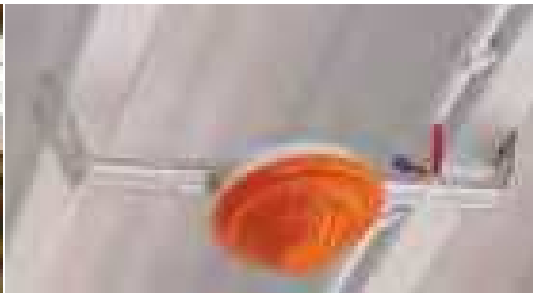

3-4

TRAPEZE

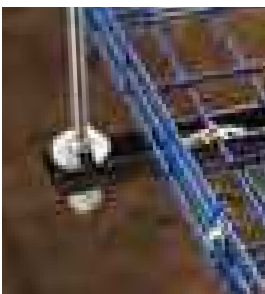

6-11, 6-8, 5-31, 1-27

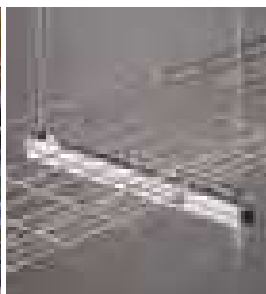

7-25



7-22, 11-4



11-38, 6-10, 11-2, 5-31

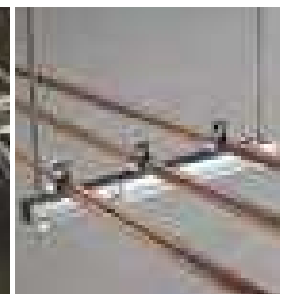

6-9, 9-31, 5-31

Product Applications

WIRE ROPE



7-5, 7-6, 2-4



7-5, 7-7

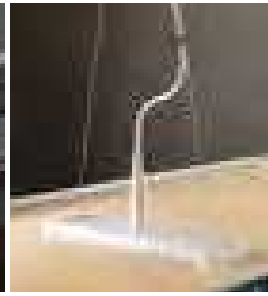

7-20, 7-34

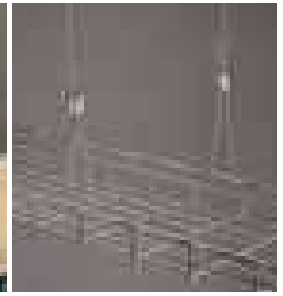

7-30



7-22



7-22, 11-2



7-19



7-13



7-13



7-10, 11-4



7-30, 7-32, 3-5



7-30

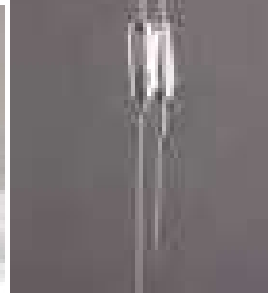

7-30, 5-9

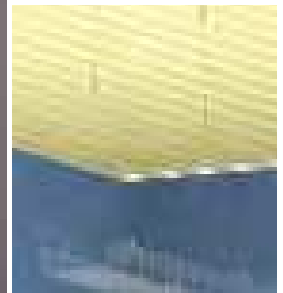

7-12, 7-27



7-30

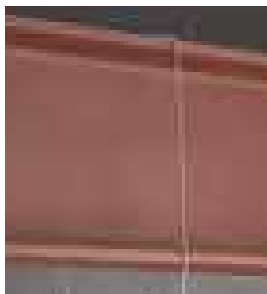

7-15, 7-28



7-14, 5-29



7-14

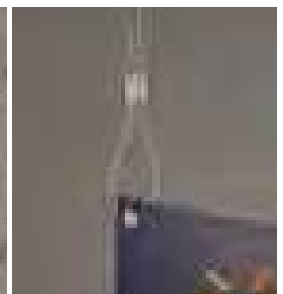

7-16, 7-23, 5-3



7-29, 7-30



7-16, 7-23, 5-47, 5-48



7-8, 7-5

Product Applications

STRUCTURAL ATTACHMENTS



1-14

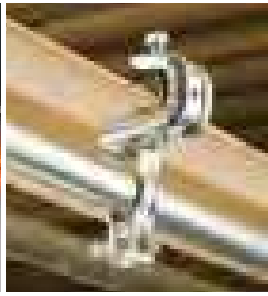

1-2

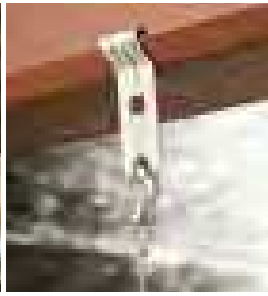

5-9, 7-14

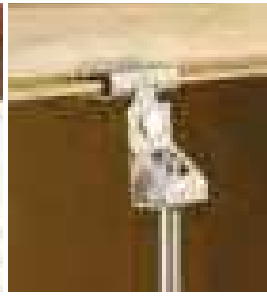

5-15, 5-31

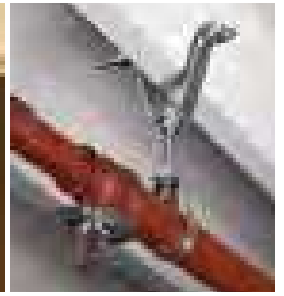

5-21, 9-4, 9-8, 5-30, 5-37



5-22, 5-31

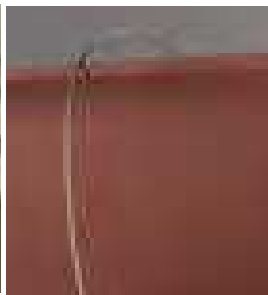

5-26, 5-31



7-10, 11-4



5-24, 5-31



5-23, 5-31



7-30



5-23, 5-31



5-23, 7-14



5-24, 9-11, 5-44, 5-30, 5-37



5-25, 9-11, 5-44, 5-30

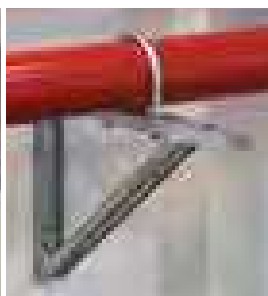

5-26, 9-39, 5-44



5-51, 5-42



5-41, 9-51

Product Applications

THREADED ROD



5-11, 5-31

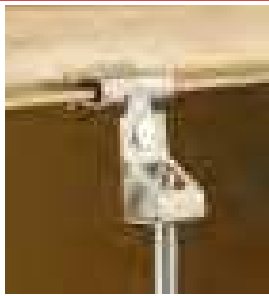

5-15, 5-31



5-2, 5-31

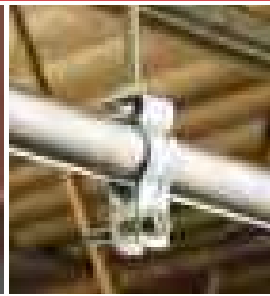

1-20, 5-31, 5-37

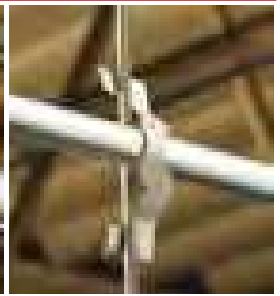

1-17



9-10, 5-31



5-20, 5-31



6-6, 5-31



6-10, 11-2, 5-31

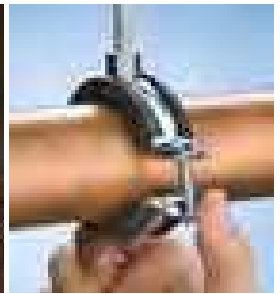

9-15, 5-31



5-22, 5-31



9-6, 5-31

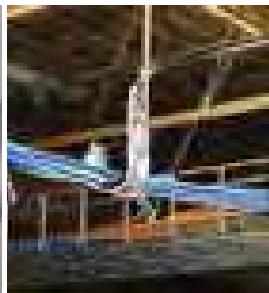

4-7, 5-31



5-23, 5-31



5-25, 9-11, 5-44, 5-30



6-7, 5-36, 5-37, 5-31



6-9, 1-27, 5-31

Product Applications

CABLE / CONDUIT



2-3

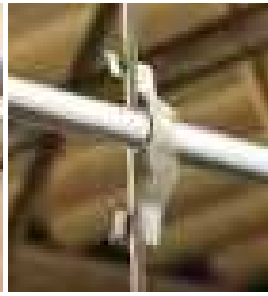

1-17

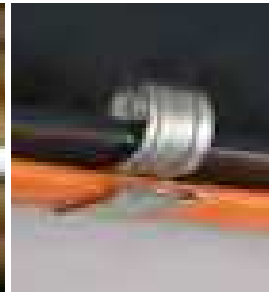

1-8

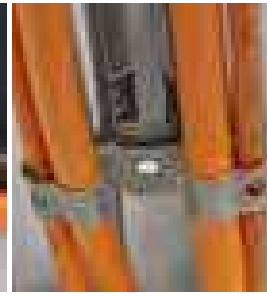

1-16



1-15



1-2

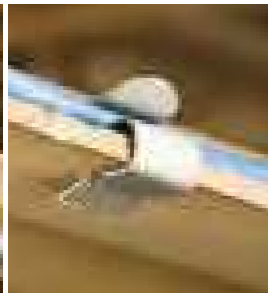

1-10

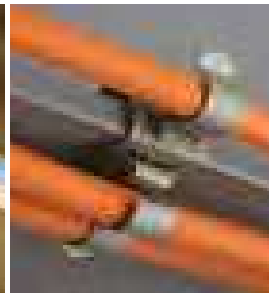

1-11, 1-10

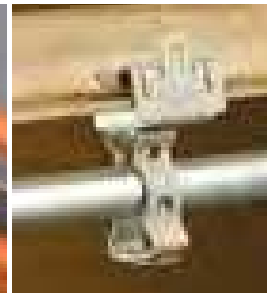

1-4

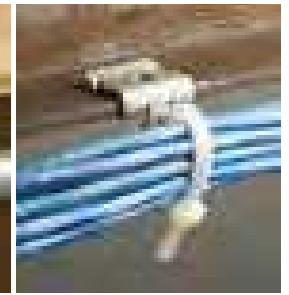

1-12



1-5

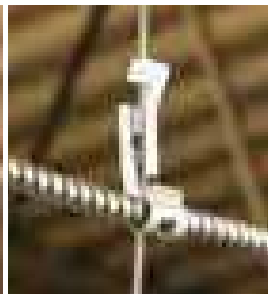

1-18



2-2



1-21

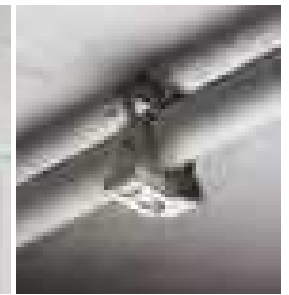

1-19

Product Applications

PIPE



8-4, 9-32



8-7



8-14



9-20



9-32, 11-2



9-4, 5-31

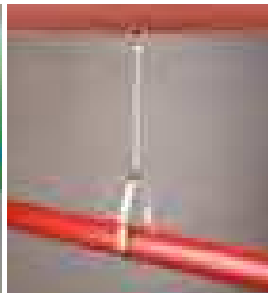

9-5, 5-3, 5-31



9-15



9-11, 5-25, 5-44, 5-30



9-4, 9-8, 5-31



5-21, 9-4, 9-8, 5-30, 5-37



6-9, 9-32, 1-27, 5-31

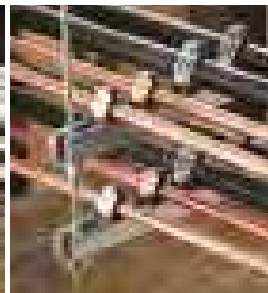

6-9, 9-32, 5-31



1-26, 1-25



9-11, 5-24, 5-44, 5-30, 5-37



9-19, 11-8, 11-3, 5-37

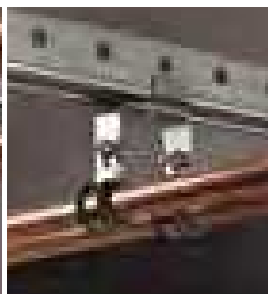

9-19, 11-3, 5-36, 11-19, 11-9



1-5



9-29, 6-5, 5-30



9-42, 9-12



9-35

Product Applications

DUCT



9-49, 9-50, 5-36, 5-37



6-10, 11-4



7-30



9-47, 5-31

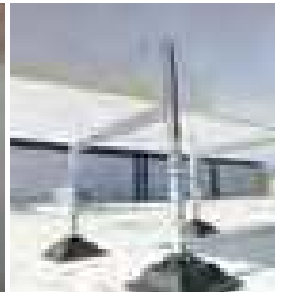

8-8, 11-2



7-14, 7-32, 3-5



7-30, 11-2



7-30, 11-52, 3-5



9-48, 5-31



9-52, 3-5, 5-31

ROOFTOP



8-15



8-9



8-5, 11-12

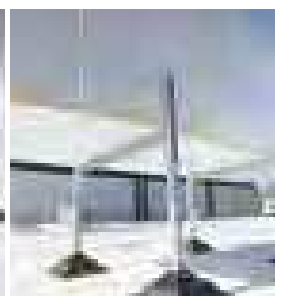

8-8, 11-2



8-5, 9-32

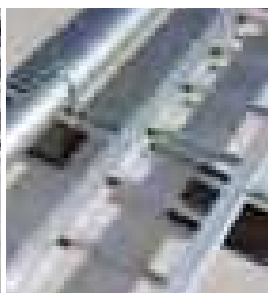

8-5, 9-33, 11-29



8-5, 8-6



8-14

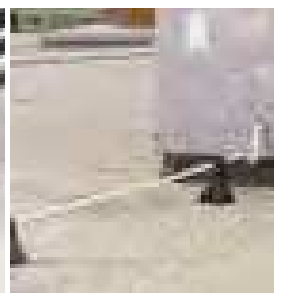

8-13

Product Applications

STRUT



11-8, 9-8, 5-34, 11-3



11-41, 7-14, 11-2



11-14, 11-7, 5-43

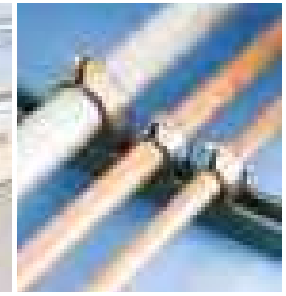

9-31



7-21, 11-4



11-38, 6-10, 11-2, 5-31



11-8, 9-10, 11-2

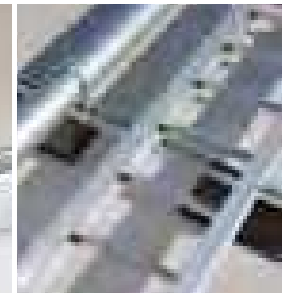

8-5, 9-33, 11-29



5-8



11-32, 11-2



11-29, 11-2

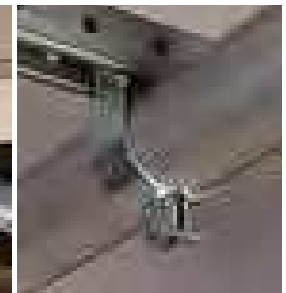

9-32, 11-3



11-37



11-36, 11-3



11-16, 5-43

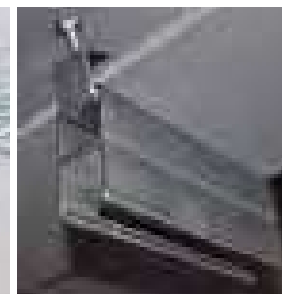

11-30, 11-3



5-6



11-30, 11-2



5-6

Product Applications

RIGID BRACING



10-4, 10-10, 10-12



10-5, 10-10, 10-12



10-8, 10-10, 10-7, 10-14, 5-45



10-5, 10-8, 10-10



10-8, 5-45



10-5, 10-8

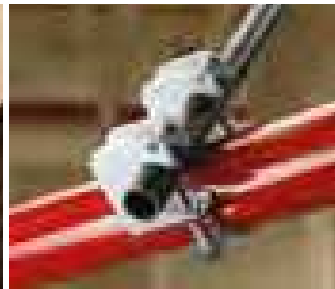

10-14



10-12

CABLE BRACING

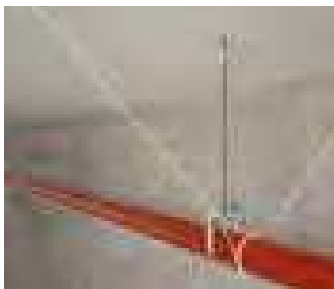

10-16, 9-2, 5-47, 5-31

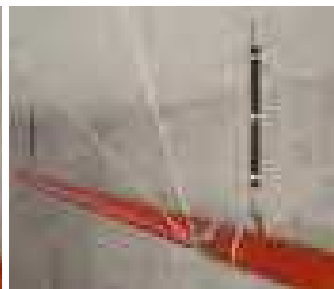

10-17, 10-16, 10-22, 9-20, 9-4, 5-47, 5-31



10-17, 10-16

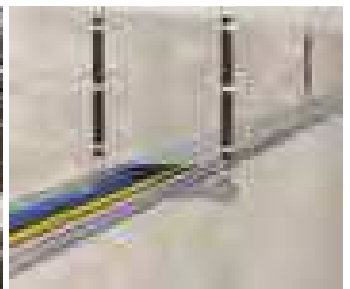

10-17, 10-16, 10-22

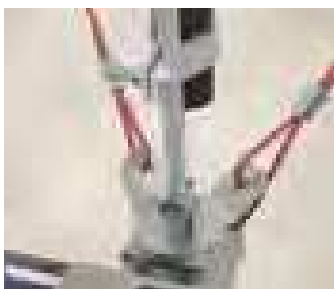

10-17, 10-16, 10-22



10-17, 10-16, 10-22, 9-20

Product Applications

BRANCH LINE RESTRAINT



10-20, 5-31, 9-4



10-20, 5-31



10-21, 5-31



10-21, 5-2, 5-31

ROD STIFFENERS



10-22, 11-2, 5-31



10-22, 5-31

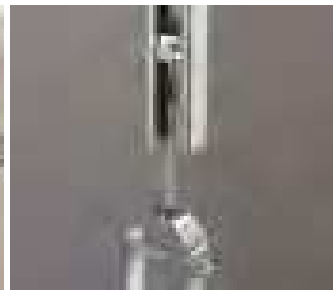

10-22, 11-2, 9-2, 5-31

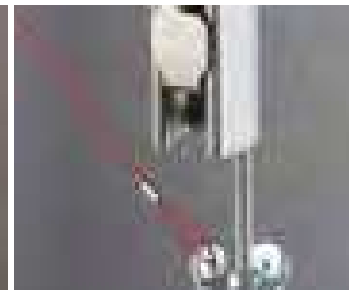

10-22, 10-16, 10-17

Picture Reference

STAINLESS STEEL RANGE



1-4

EM-M Conduit/Pipe to Flange Clip



1-5

H-MSM Conduit/Pipe to Flange Clip, Side Mount



1-12

Cable Tie with Flange Clip



1-13

Cable Tie Holder with Flange Clip



1-19

Snap Close Conduit/Pipe Clamp



1-25

Pipe/Cable Clamp



1-26

Multi-Function C-Clamp



1-26

Flange Protector for Multi-Function C-Clamp



1-27

Square Nut for Multi-Function C-Clamp



1-28

Cable Tray to Strut Clip



2-3

CHN Chain



2-4

S Hook

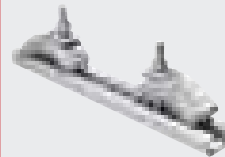

5-7

5000 Beam Clamp Kit



5-11

Hammer-On Flange Clip, Bottom Mount



5-12

Hammer-On Flange Clip, Bottom Mount with Stud



5-13

Hammer-On Flange Clip, Side Mount



5-25

PBF Two Hole Base Plate for Threaded Rod



5-31

Threaded Rod



5-33

Pipe Thread Connector



5-36

VDF TORX Wood-to-Metal Screw with TORX® Head



5-37

Hex Nut



5-38

Flat Washer



5-42

Cable Tie Fastener



5-42

Cable Tie, Stainless Steel

Picture Reference

STAINLESS STEEL RANGE



5-43
Bolt Expansion Anchor



5-47
Drop-In Anchor



5-51
Light Duty Push-in Anchor



7-26
nVent CADDY Speed Link LD with Hook



7-31
nVent CADDY Speed Link LD Locking Device



8-13
nVent CADDY Pyramid Universal Support



9-11
nVent CADDY Macrofix Insulated M8/M10, Stainless Steel



9-18
PX Heavy Duty Pipe Clamp with External Thread



9-24
PX NI Heavy Duty Pipe Clamp with External Thread



9-26
nVent CADDY Macrofix Non-Insulated M8/M10, Stainless Steel



9-30
700 Offset Pipe Clamp

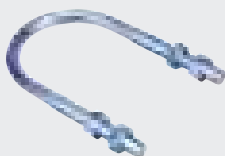

9-39
U-Bolt



9-49
ABP Perforated Strap with Rounded Edge, Standard Duty



9-52
Sign Support Bracket for Round Pole, One Hole

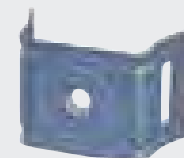

9-53
Sign Support Bracket for Flat Surface, One Hole



9-53
Sign Support Bracket for Round Pole, Two Hole



9-53
Sign Support Bracket for Flat Surface, Two Hole



9-54
Sign Support Bracket with Slotted Holes



9-54
Heavy Duty Strap Buckle



9-54
Standard Duty Strap Buckle



9-55
Metal Strap



10-22
nVent CADDY Quick Clip Rod Stiffener



11-2
Strut Channel Type A, Slotted



11-3
Strut Channel Type C, Slotted



11-9
Strut Nut without Spring

Picture Reference

STAINLESS STEEL RANGE



11-10

Strut Nut with Spring, Channel Type A



11-11

Strut Nut with Spring, Channel Type C



11-12

Strut T-Bolt

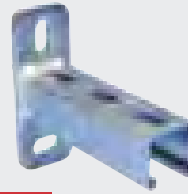

11-14

Strut Cantilever Arm Type A, Slotted



11-17

Saddle Washer

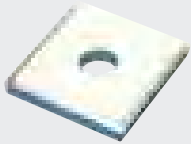

11-17

Square Channel Washer



11-18

Two Hole Flat Bracket



11-18

Three Hole Flat Bracket



11-19

Three Hole Flat Corner Bracket

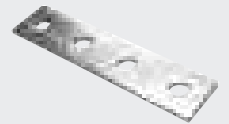

11-19

Four Hole Flat Bracket



11-20

Four Hole Flat Tee Plate



11-21

1-1 Hole Angle Bracket



11-23

1-2 Hole Corner Short Angle Bracket



11-25

2-2 Hole Corner Angle Bracket



11-29

Strut Beam Clamp with U-Bolt



11-29

Strut Beam Clip



11-31

Heavy Duty Strut Beam Clamp



11-39

Z-Shaped Bracket for Strut Type A

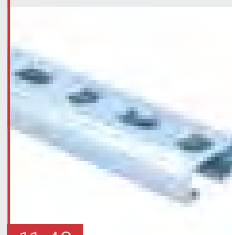

11-43

C-Channel Type E5, Perforated



11-48

ECN Nut for C-Channel E5



11-48

ECN Square Nut for C-Channel E5



11-62

APX External Vertical Wall Bracket



11-62

APY External Horizontal Wall Bracket

Picture Reference

CABLE/CONDUIT



1-2

BC200-CD Conduit to Beam Clamp



1-2

EM-P Conduit to Flange Clip



1-3

H-PSM Conduit to Flange Clip, Side Mount



1-3

H-PIN Conduit to Flange Clip



1-4

EM-M Conduit/Pipe to Flange Clip



1-5

H-MSM Conduit/Pipe to Flange Clip, Side Mount



1-6

BC-M Conduit to Beam Clamp



1-6

BC-MSM Conduit to Beam Clamp, Side Mount



1-7

HK Cable Snap Clip



1-7

HSC Hole Snap Clip



1-8

LB3B Cable Snap Clip



1-8

LF2/LF3 Cable Snap Clip



1-8

LF4/LF5 Cable Snap Clip



1-9

LR Cable Snap Clip



1-9

Solar Snap Clip

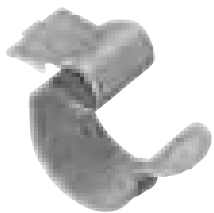

1-10

SC Cable Snap Clip



1-11

SCA Cable Snap Clip Adaptor



1-11

SCB Cable Snap Clip Adaptor



1-11

SCD Dovetail Mount Cable Snap Clip Adaptor



1-12

Cable Tie with Flange Clip



1-13

Cable Tie Holder with Flange Clip



1-14

Cable Tie Holder with Inverted Flange Clip



1-14

Cable to Flange Clip















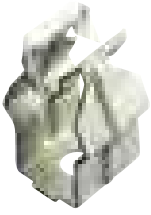
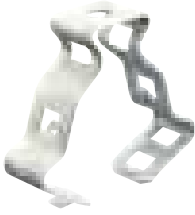

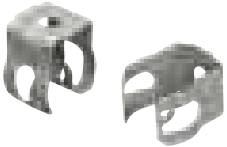



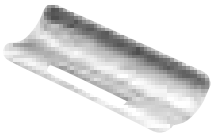

1-15

Double Cable to Flange Clip

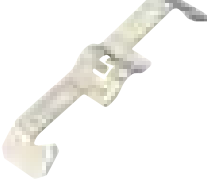
Picture Reference

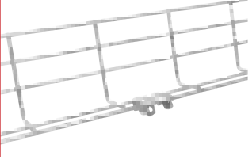
CABLE/CONDUIT

				
1-16 SCD Multi-Cable to Deck Clip	1-16 J-CT Cable Tie Holder with C Purlin Clip	1-17 Cable/Conduit Clip	1-18 Cable/Conduit to Wire Clip	1-18 Snap Close Conduit to Rod/Wire Clip
				
1-19 Push In Conduit Clamp	1-19 Snap Close Conduit/Pipe Clamp	1-20 Bolt Close Conduit/Pipe Clamp	1-20 Push In Conduit to Conduit Clamp	1-21 Wall Mount Conduit Clip
				
1-21 C-EC Cable to Strut Clamp	1-22 C-EU Single Cable to Flange Clamp	1-23 C-ES Cable to Vertical Flange Clamp	1-24 C-GW Cable Protection Plate	1-24 C-LW Protection Plate for Cable Clamps
				
1-25 Pipe/Cable Clamp	1-26 Multi-Function C-Clamp	1-26 Flange Protector for Multi-Function C-Clamp	1-27 Square Nut for Multi-Function C-Clamp	1-27 WMX Cable Hanger
				
1-27 Wire Basket Tray Clip	1-28 Cable Tray to Strut Clip	1-28 Cable to Flange Clip	1-28 Double Cable to Flange Clip	1-29 Universal Tray Support Clip

Picture Reference

CABLE/CONDUIT



1-29

Wire Basket Support Clip



1-30

Wire Basket Support Clip, Retrofit

CEILING/ACOUSTICAL

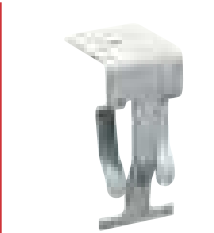

2-2

T-Grid Clip, Top Mount

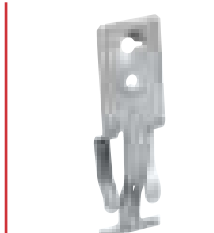

2-2

T-Grid Clip, Side Mount

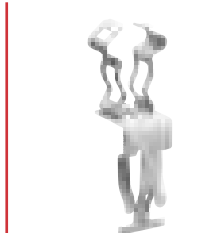

2-2

MATA Conduit to T-Grid Clip

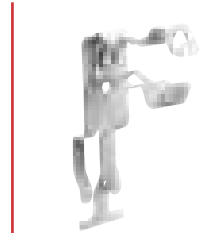

2-3

MATS Conduit to T-Grid Clip



2-3

CHK Chain



2-3

CHN Chain



2-4

KN Hook

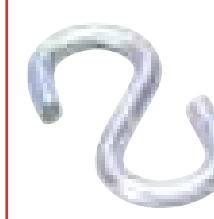

2-4

S Hook

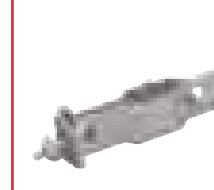

2-5

Independent Support Clip



2-5

4G16 Twist Clip



2-6

4G16 Twist Clip with Stud



2-6

4G16 Twist Clip with Wing Nut

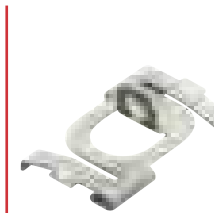

2-6

4G16H Twist Clip with 90° Plain Hole



2-7

4G24 Twist Clip with Stud



2-7

4G24 Twist Clip with Wing Nut

Picture Reference

CEILING/ACOUSTICAL



2-8

4G24H Twist Clip with 90° Plain Hole



2-8

4J15 Twist Clip with Stud, Narrow Grid



2-8

Wing Nut for Twist Clips

STUD WALL



3-2

MSF Snap-On Box Support



3-2

Adjustable Depth Snap-On Switch Box Support



3-2

"Colorado Jim" Cable Support



3-3

"Colorado Jim" Cable Support with Standoff



3-3

CS812 Cable/Conduit to Stud Attachment



3-4

Telescoping Screw Gun Box Bracket

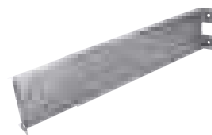

3-4

Barrnog/TSGBHD Adjustable Metal Nogging

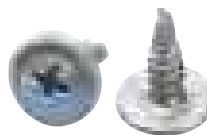

3-5

SMS8 Self-Drilling and Tapping Screw



3-5

Easy Snap Grommet















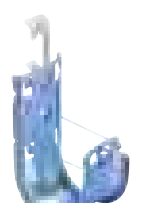







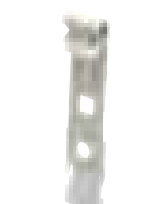

3-5

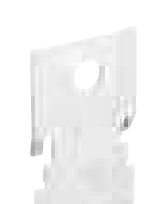
MSP20 Metal Stud Punch for Easy Snap Grommet

Picture Reference

DATACOM/LOW VOLTAGE

 <p>4-2 nVent CADDY Cat HP J-Hook</p>	 <p>4-3 nVent CADDY Cat HP J-Hook with BC Beam Clamp</p>	 <p>4-4 nVent CADDY Cat HP J-Hook with BC Beam Clamp, Swivel</p>	 <p>4-5 nVent CADDY Cat HP J-Hook with Hammer-On Flange Clip</p>	 <p>4-6 nVent CADDY Cat HP J-Hook with Hammer-On Flange Clip, Swivel</p>
 <p>4-7 nVent CADDY Cat HP J-Hook with Multi-Function Clip</p>	 <p>4-8 nVent CADDY Cat HP J-Hook with Nail Gun Bracket</p>	 <p>4-9 nVent CADDY Cat HP J-Hook with Angle Bracket</p>	 <p>4-10 nVent CADDY Cat HP J-Hook with T-Grid Clip</p>	 <p>4-10 nVent CADDY Cat HP J-Hook Clip to BC200 Beam Clamp</p>
 <p>4-11 nVent CADDY Cat HP J-Hook Clip to BC Beam Clamp</p>	 <p>4-11 nVent CADDY Cat HP J-Hook Clip to BC Beam Clamp, Swivel</p>	 <p>4-12 nVent CADDY Cat HP J-Hook Clip to Hammer-On Flange Clip, Swivel</p>	 <p>4-12 nVent CADDY Cat HP J-Hook Clip to C Purlin Clip</p>	 <p>4-13 nVent CADDY Cat HP J-Hook Clip to Rod/Wire Clip</p>
 <p>4-13 nVent CADDY Cat HP J-Hook Clip to Strut Clip</p>	 <p>4-14 nVent CADDY Cat HP J-Hook Clip to Pedestal Clamp</p>	 <p>4-14 nVent CADDY Cat HP J-Hook Angle Bracket</p>	 <p>4-15 nVent CADDY Cat HP J-Hook Straight Bracket</p>	 <p>4-15 nVent CADDY Cat HP J-Hook Tree Mount Bracket</p>
 <p>4-16 nVent CADDY Cat HP Cable Puller Kit</p>	 <p>4-16 nVent CADDY Cat HP Wire Retainer</p>	 <p>4-17 nVent CADDY Cat CM Double J-Hook</p>	 <p>4-17 nVent CADDY Cat 425 Adjustable Cable Support</p>	 <p>4-18 nVent CADDY Cat 425 Wall Mount Adjustable Cable Support</p>

Picture Reference

DATACOM/LOW VOLTAGE



4-18
Threaded Bridle Ring

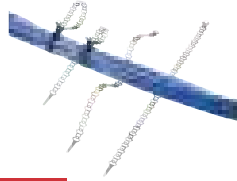

4-19
nVent CADDY Mille-Tie



4-19
QSC Multi-Cable Clip for Pin Drivers



4-19
QSC Multi-Cable Clip



4-20
Metal Pressure Clip, Fire-Rated



4-21
Metal Pressure Clip



4-21
Metal Pressure Clip Insert



4-22
Metal Pressure Clip with Nail Gun Insert



4-22
Nail Gun Insert

STRUCTURAL ATTACHMENTS



5-2
300M Universal Beam Clamp



5-2
310M Universal Beam Clamp, Thick Flange



5-3
EBC Beam Clamp



5-3
BC200/BC400 Beam Clamp



5-4
Beam Clamp with Swivel



5-5
35RS Two Hole Retainer Strap

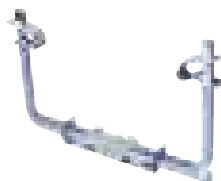

5-5
UBH Concrete Beam Clamp



5-5
UBHT Concrete Beam Clamp with Cantilever Arm













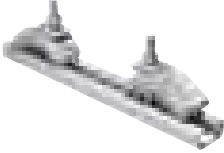
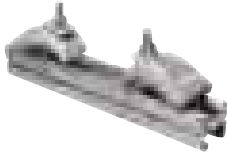









5-5
Wire Cable Tray Clip for UBHT Series



5-6
2000 Beam Clamp Kit

Picture Reference

STRUCTURAL ATTACHMENTS

				
5-6 3000 Beam Clamp Kit	5-7 5000 Beam Clamp Kit	5-7 6000 Beam Clamp Kit	5-8 6000 Beam Clamp Kit with Swivel	5-8 D1 Purlin Clamp
				
5-9 122 Series Z Purlin Clip	5-9 123 Series Z Purlin Clip	5-9 AF Series Z Purlin Clip	5-10 J Series C Purlin Clip	5-10 PW2 Series C Purlin Clip
				
5-10 VF Series C Purlin Clip	5-11 VAFT Installation Tool for Purlin Clips	5-11 Hammer-On Flange Clip, Bottom Mount	5-12 Hammer-On Flange Clip, Bottom Mount with Stud	5-13 Hammer-On Flange Clip, Side Mount
				
5-13 Hammer-On Flange Clip, Two Hole Side Mount	5-14 Hammer-On Flange Clip, Vertical Mount	5-14 Hammer-On Flange Clip, Vertical Mount with Stud	5-14 BC-MA Rod to Beam Clamp	5-15 H-Ti/T Rod to Flange Clip
				
5-15 nVent CADDY Rod Lock Spring Steel Rod Hanger to Beam Clamp	5-16 nVent CADDY Rod Lock Spring Steel Rod Hanger to Flange Clip	5-16 122-Ti/T Rod to Z Purlin Clip	5-17 nVent CADDY Rod Lock Spring Steel Rod Hanger to C Purlin Clip	5-17 J-Ti/T Rod to C Purlin Clip

Picture Reference

STRUCTURAL ATTACHMENTS



5-18

PW2-Ti/T Rod to C Purlin Clip

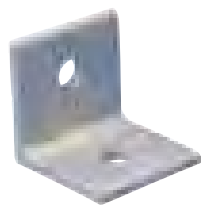

5-18

325M Steel Side Beam Attachment



5-19

38 Offset Steel Eye Socket Rod Hanger

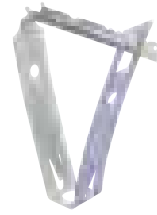

5-19

TDH Trapezoidal Deck Hanger



5-20

TDHM Trapezoidal Deck Hanger with Fixed Nut



5-20

TDHP Trapezoidal Deck Hole Punch



5-20

Replacement Die for TDHP Trapezoidal Deck Hole Punch



5-21

TBHK Trapezoidal Deck Hanger



5-21

TBHKM Trapezoidal Deck Hanger with Fixed Nut



5-22

EER Trapezoidal Deck Hanger



5-22

EER-Ti/T Trapezoidal Deck Threaded Rod Hanger



5-22

VKR Trapezoidal Deck Hanger



5-23

OCDC Deck Hanger



5-23

OCDC-Ti/T Deck Threaded Rod Hanger

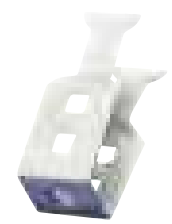

5-23

GTD Dovetail Deck Hanger

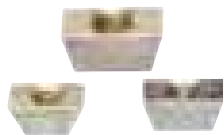

5-24

HW Wedge Nut for Dovetail Deck Hanger



5-24

AB-C Ceiling to Rod Mounting Bracket



5-25

PBF Two Hole Base Plate for Threaded Rod



5-25

PBF Two Hole Base Plate for Threaded Pipe

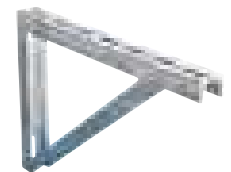

5-26

Triangular Wall Bracket



5-26

Thread Install Rod Hanger



5-26

nVent CADDY Rod Lock Spring Steel Rod Hanger



5-27

Thread Install Rod Hanger with Angle Bracket



5-27

nVent CADDY Rod Lock Spring Steel Rod Hanger with Nail Gun Bracket



5-28

Thread Install Rod Hanger with Nail Gun Bracket

Picture Reference

STRUCTURAL ATTACHMENTS



5-28
L-Bracket



5-29
Angle Bracket with Nail Gun Bracket

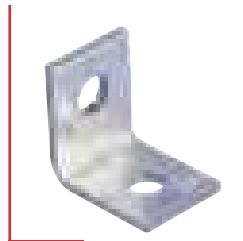

5-29
Angle Bracket

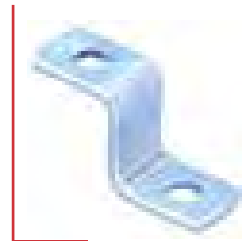

5-29
Z-Bracket

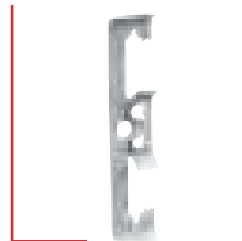

5-30
Multi-Function Clip

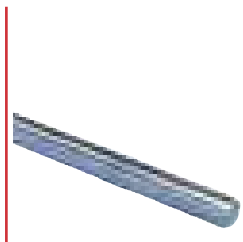

5-31
Threaded Rod

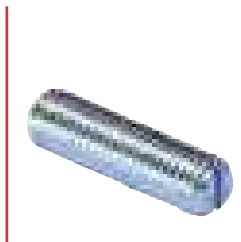

5-31
Threaded Stud with Slot

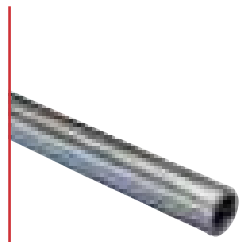

5-32
Externally Threaded Pipe

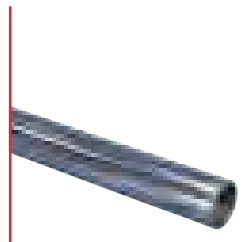

5-32
Internally Threaded Pipe



5-32
EM-HEX Rod Coupler



5-33
EM Round Rod Connector



5-33
Pipe Thread Connector

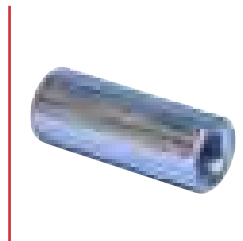

5-33
RFF Round Rod Reducer

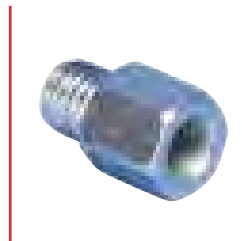

5-34
RMF Hex Male-Female Reducer



5-34
RTU Ball Swivel

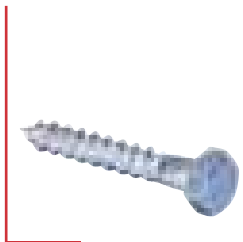

5-35
42 Hex Head Lag Screw

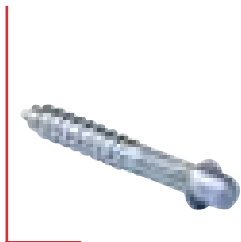

5-35
VDF C Wood-to-Metal Dowel Screw with Collar



5-35
VDF T Drive Tool for Dowel Screws



5-36
VDF TORX Wood-to-Metal Screw with TORX® Head



5-36
Hex Head Bolt

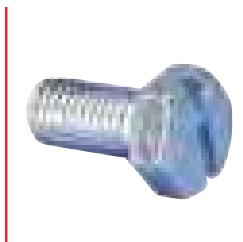

5-37
Slotted Hex Head Bolt



5-37
Hex Nut

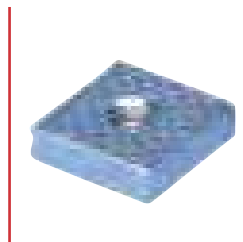

5-38
Universal Square Nut



5-38
Flat Washer



5-39
Large Washer

Picture Reference

STRUCTURAL ATTACHMENTS

				
5-39 EB-H Wood Eye Bolt	5-40 ES Eye Socket	5-40 LLS-H Slotted Wood Eye Bolt	5-40 LLS-M Slotted Eye Bolt	5-41 OSM Eye Bolt
				
5-41 HIB Concrete Nail with Collar	5-41 HIBT Nail Drive Tool	5-42 Cable Tie Fastener	5-42 Cable Tie, Stainless Steel	5-43 Bolt Expansion Anchor
				
5-44 BSZ-SU Concrete Screw	5-45 BSZ-M Concrete Screw	5-45 SZ-B High Load Concrete Anchor	5-46 Threaded Nail Anchor	5-47 Drop-In Anchor
				
5-48 Flanged Drop-in Anchor	5-48 Hammer-In Tool for Drop-in Anchors	5-49 Metal Plug	5-49 Brass Expansion Anchor	5-49 Cavity Plug
				
5-50 Setting Tool for Metal Expansion Anchor	5-50 Light Duty Expansion Anchor	5-51 Light Duty Push-In Anchor	5-51 NPN Hammer-In Expansion Anchor with Screw	5-52 FPN Universal Anchor

Picture Reference

STRUCTURAL ATTACHMENTS



5-52

PWM/PWN Self-Drilling Drywall Anchor

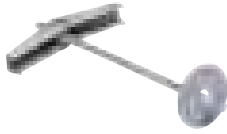

5-53

MTSB Spring Toggle with Nut/Washer



5-53

MTSH Spring Toggle with Hook

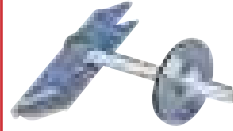

5-54

MTVB Gravity Toggle with Rubber Washer

NVENT CADDY ROD LOCK THREADED ROD MOUNTING SYSTEM



6-5

nVent CADDY Rod Lock Beam Clamp



6-6

nVent CADDY Rod Lock Anchor Screw



6-6

nVent CADDY Rod Lock Anchor Screw Drive Socket



6-7

nVent CADDY Rod Lock L-Bracket

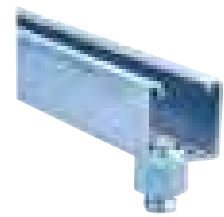

6-8

nVent CADDY Rod Lock Strut



6-9

nVent CADDY Rod Lock Telescoping Strut Replacement



6-10

nVent CADDY Rod Lock Channel Nut



6-10

SN Series Nut



6-11

SNSW Flanged Nut

Picture Reference

NVENT CADDY SPEED LINK UNIVERSAL SUPPORT SYSTEM



7-5

nVent CADDY Speed Link Catenary Kit



7-5

nVent CADDY Speed Link Catenary Cable Spool

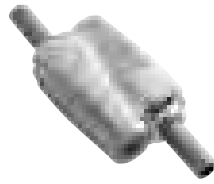

7-6

nVent CADDY Speed Link Catenary Locking Device



7-6

Drop Wire Clip

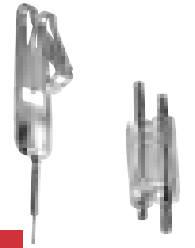

7-7

nVent CADDY Speed Link SLK with Drop Wire Clip



7-8

Eye Nut



7-8

Beam Attachment Kit

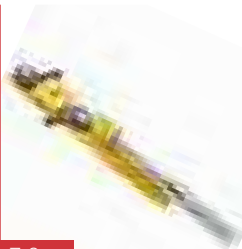

7-8

Catenary Tensioning Tool



7-9

nVent CADDY Speed Link SLK with Angle Bracket



7-10

nVent CADDY Speed Link SLK with Shot-Fire Bracket



7-11

nVent CADDY Speed Link SLK with Nail Gun Bracket

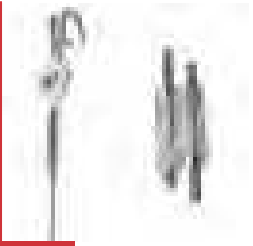

7-12

nVent CADDY Speed Link SLK with Decking Hook

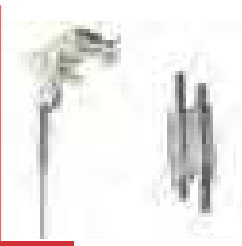

7-13

nVent CADDY Speed Link SLK with Hammer-On Flange Clip



7-14

nVent CADDY Speed Link SLK with Hook

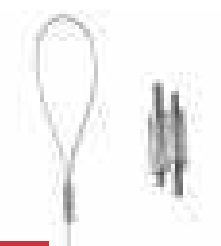

7-15

nVent CADDY Speed Link SLK with Loop

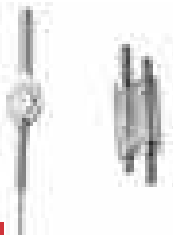

7-16

nVent CADDY Speed Link SLK with Threaded Stud End

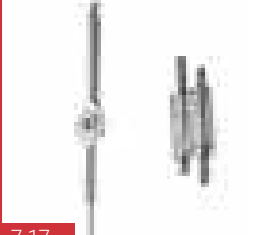

7-17

nVent CADDY Speed Link SLK with Wedge Anchor

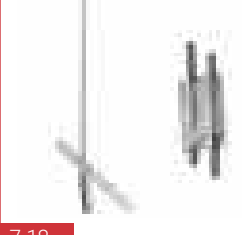

7-18

nVent CADDY Speed Link SLK with Toggle

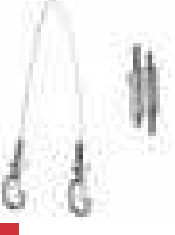

7-19

nVent CADDY Speed Link SLK with Y-Hook



7-20

nVent CADDY Speed Link SLK with Y-Toggle

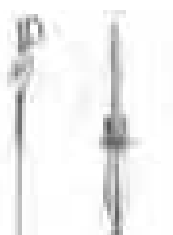

7-21

nVent CADDY Speed Link SLS with Decking Hook



7-22

nVent CADDY Speed Link SLS with Hook

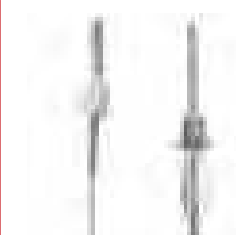

7-23

nVent CADDY Speed Link SLS with Threaded Stud End

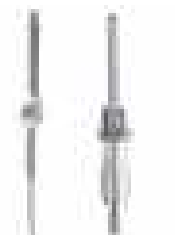

7-24

nVent CADDY Speed Link SLS with Wedge Anchor

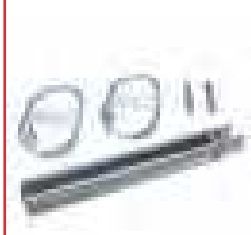

7-25

nVent CADDY Speed Link SLS Trapeze Kit

Picture Reference

NVENT CADDY SPEED LINK UNIVERSAL SUPPORT SYSTEM

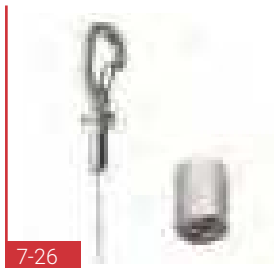

7-26

nVent CADDY Speed Link LD with Hook



7-26

nVent CADDY Speed Link SLDM with Hook



7-27

nVent CADDY Speed Link SLDM with Toggle



7-27

nVent CADDY Speed Link Y-Hook with Eyelet Extension

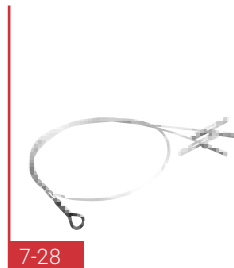

7-28

nVent CADDY Speed Link Y-Toggle with Eyelet Extension



7-28

nVent CADDY Speed Link Quad-Toggle with Eyelet Extension



7-29

nVent CADDY Speed Link SLK Spool Kit



7-29

nVent CADDY Speed Link SLK Spool Kit with Wire Rope Cutter



7-30

nVent CADDY Speed Link SLK Locking Device

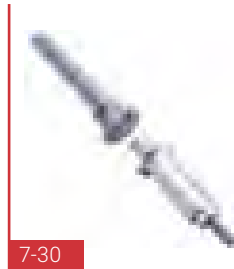

7-30

nVent CADDY Speed Link SLS Locking Device



7-31

nVent CADDY Speed Link LD Locking Device



7-31

Wire Spool

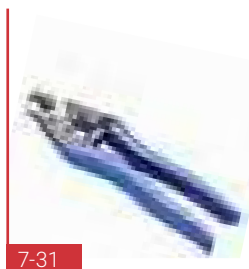

7-31

Wire Rope Cutter



7-32

Air Duct Corner Protector



7-32

Air Duct Support Attachment



7-33

Concrete Fixing Eyebolt Screw



7-33

Wood Fixing Eye Screw



7-33

Eye Screw



7-34

MC/AC Cable Clip

Picture Reference

NVENT CADDY PYRAMID ROOFTOP SYSTEMS



8-4

nVent CADDY Pyramid ST Fixed Strut Support



8-5

nVent CADDY Pyramid ST Adjustable Strut Support



8-5

nVent CADDY Pyramid ST Bridge Assembly



8-6

nVent CADDY Pyramid RL Fixed Roller Support



8-7

nVent CADDY Pyramid RL Adjustable Roller Support



8-7

Retainer Strap



8-8

nVent CADDY Pyramid H-Frame Post Base

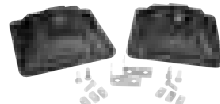

8-8

nVent CADDY Pyramid H-Frame Kit

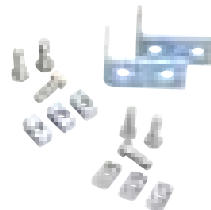

8-9

nVent CADDY Pyramid H-Frame Hardware Kit



8-9

nVent CADDY Pyramid Equipment Support Kit, 4 Post Base



8-10

nVent CADDY Pyramid Equipment Support Kit, 6 Post Base

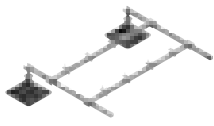

8-10

nVent CADDY Pyramid Equipment Support Frame Extension Kit



8-11

nVent CADDY Pyramid Equipment Support Height Extension



8-11

nVent CADDY Pyramid Equipment Support Post Base

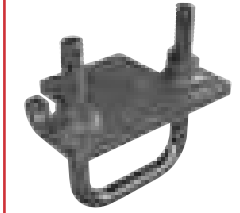

8-12

nVent CADDY Pyramid Equipment Support Clamp

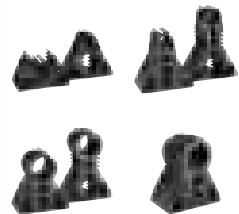

8-13

nVent CADDY Pyramid EZ Rubber-Based Adjustable Support



8-13

nVent CADDY Pyramid Universal Support



8-14

nVent CADDY Pyramid Tool-Free Pipe Support Kit



8-14

nVent CADDY Pyramid Tool-Free Pipe Clamp



8-15

nVent CADDY Pyramid Tool-Free Cable Tray Support Kit



8-15

nVent CADDY Pyramid Tool-Free Cable Tray Pin



























8-16

nVent CADDY Pyramid 25 Pipe and Conduit Support, Plastic

Picture Reference

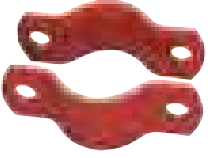
MECHANICAL

 <p>9-2 401 Clevis Hanger</p>	 <p>9-3 410 Clevis Hanger, Light Duty</p>	 <p>9-4 115 Standard Duty Loop Hanger</p>	 <p>9-5 Drop-In Loop Hanger</p>	 <p>9-6 FCS Height Adjustable Loop Hanger</p>
 <p>9-7 Fixing Set for FCS Loop Hanger</p>	 <p>9-7 Hex Flange Nut</p>	 <p>9-8 115 Surge Restraint</p>	 <p>9-8 DH Surge Restraint</p>	 <p>9-9 nVent CADDY Macrofix Insulated M8</p>
 <p>9-10 nVent CADDY Macrofix Insulated M8/M10</p>	 <p>9-11 nVent CADDY Macrofix Insulated M8/M10, Stainless Steel</p>	 <p>9-12 nVent CADDY Macrofix Plus</p>	 <p>9-13 nVent CADDY Macrofix Plus Kombi with Combination Nut</p>	 <p>9-14 nVent CADDY Macrofix Plus LF Low-Friction</p>
 <p>9-15 nVent CADDY Superfix 243 M8</p>	 <p>9-16 nVent CADDY Superfix 243 M8/M10</p>	 <p>9-17 HD Heavy Duty Pipe Clamp</p>	 <p>9-18 PX Heavy Duty Pipe Clamp with External Thread</p>	 <p>9-19 nVent CADDY Microfix Double Pipe Clamp</p>
 <p>9-19 nVent CADDY Microfix Double Pipe Strap, Adjustable</p>	 <p>9-20 Heavy Duty Pipe Clamp per DIN 3567</p>	 <p>9-21 Heavy Duty Pipe Clamp</p>	 <p>9-22 HD NI Heavy Duty Pipe Clamp, Fire/Sprinkler</p>	

Picture Reference

MECHANICAL



9-25

nVent CADDY Macrofix
Non-Insulated M8/M10



9-26

nVent CADDY Macrofix
Non-Insulated M8/M10,
Stainless Steel



9-27

nVent CADDY Macrofix
NI EZ with Easy Closure



9-28

nVent CADDY Macrofix
Plus NI EZ with Easy
Closure



9-28

DUPLO NI Double Pipe
Clamp



9-29

OVAL Oval Pipe Clamp
with Nut



9-29

nVent CADDY EZ Riser



9-30

700 Offset Pipe Clamp



9-30

STRC CU Strap Clamp
for Copper Tube



9-31

nVent CADDY Cushion
Clamp Insulated Strut
Clamp for Pipe/Tube



9-32

USC Universal Strut
Clamp for Pipe/Conduit



9-33

nVent CADDY Superklip



9-34

nVent CADDY Superklip
IN Insert Nut



9-34

RING FRF /1 Single Pipe
Clip with Plug



9-35

RING FRF /2 Double Pipe
Clip with Plug



9-35

2HPS Two Hole Pipe
Strap

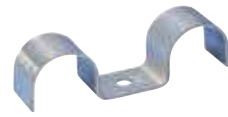

9-36

Two Hole Double Pipe
Saddle



9-36

Pipe Hook



9-37

107 Wraparound Strap
for CPVC Pipe



9-37

108 Two Hole Strap for
CPVC Pipe



9-38

109 Side Mount Strap for
CPVC Pipe



9-38

SOSR Stand Off Two
Hole Strap for CPVC
Pipe



9-39

U-Bolt



9-40

PESHO Heavy Duty Pipe
Slide, One Connector



9-40

PESHOS Heavy Duty
Pipe Slide with Strap,
One Connector

Picture Reference

MECHANICAL

				
9-41 PESHT Heavy Duty Pipe Slide, Two Connectors	9-41 PESHTS Heavy Duty Pipe Slide with Strap, Two Connectors	9-42 PESMO Medium Duty Pipe Slide, One Connector	9-42 PESMOS Medium Duty Pipe Slide with Strap, One Connector	9-43 PESMT Medium Duty Pipe Slide, Two Connectors
				
9-43 PESMTS, Medium Duty Pipe Slide with Strap, Two Connectors	9-44 PCG Medium Duty Pipe Slide	9-44 Dome Washer for Old-Style Radiator	9-44 Top Bracket Kit for Column Radiator	9-45 SIT CLIM Insulated Pipe Clamp with Rubber Ends
				
9-47 nVent CADDY Macrofix Insulated Ventilation Duct Clamp	9-48 nVent CADDY Macrofix Non-Insulated Ventilation Duct Clamp	9-49 H-MSS Inline Strap Hanger with Flange Clip	9-49 ABP Perforated Strap with Rounded Edge, Standard Duty	9-50 BP Perforated Strap with Straight Edge, Light Duty
				
9-50 SBP Perforated Strap with Straight Edge, Standard Duty	9-51 SBP-C Perforated Strap with Straight Edge, Plastic Coated	9-51 EQLS Square Duct Fixing with Sound Reducer, L-Shape	9-51 EQZS Square Duct Fixing with Sound Reducer, Z-Shape	9-52 EQVS Round Duct Fixing with Sound Reducer, V-Shape
				
9-52 TBHS Bendable Round Duct Fixing with Sound Reducer, V-Shape	9-52 Sign Support Bracket for Round Pole, One Hole	9-53 Sign Support Bracket for Flat Surface, One Hole	9-53 Sign Support Bracket for Round Pole, Two Hole	9-53 Sign Support Bracket for Flat Surface, Two Hole

Picture Reference

MECHANICAL



9-54

Sign Support Bracket with Slotted Holes



9-54

Heavy Duty Strap Buckle



9-54

Strap Tensioning Tool



9-55

Strap Tensioning Tool



9-55

Metal Strap

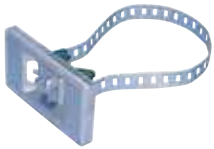

9-55

ESS UHS Sign Holder System with Strap



9-56

ESS UH Sign Holder System without Strap



9-56

ESS ST Strap



9-56

SBFF Female-Female Sound Insulator



9-57

SBFK Female-Female Compression Insulator



9-57

SBMF Male-Female Sound Insulator



9-57

SBMK Male-Male Compression Insulator



9-58

SGBC Heavy Duty Sound Insulator



9-58

IHT High-Temperature Sound Insulation Rubber



9-58

Sound Insulation Rubber for Strut Pipe Clamps

Picture Reference

SEISMIC BRACING SYSTEMS

				
10-4 Bar Joist Attachment	10-5 Adjustable I-Beam Attachment	10-6 I-Beam Attachment	10-7 Multi Attachment	10-7 Strut Seismic Hinge
				
10-8 Universal Structural Attachment	10-9 Cone Point Shear Bolt	10-9 Shear Nut	10-10 Standard Universal Sway Brace	10-12 Quick Grip Jr. Lateral Sway Brace
				
10-14 Quick Grip Lateral Sway Brace	10-15 Lateral Telescoping Brace Assembly	10-16 Cable Spool	10-16 Cable Spool	10-16 Oval Sleeve
				
10-17 Universal Restraint Clip	10-17 Universal Restraint Clip, Retrofit	10-18 No Pry Clip	10-18 Cable Cutter	10-18 Wire Rope Cutter
				
10-19 Manual Swaging Tool	10-19 Multi-Size Manual Swaging Tool	10-19 Battery-Operated Swaging Tool	10-20 Branch Line Restraint Pipe Attachment	10-20 Branch Line Restraint Structure Attachment to Steel

Picture Reference

SEISMIC BRACING SYSTEMS



10-21

Branch Line Restraint
Structure Attachment to
Wood/Concrete



10-21

Branch Line Restraint
Structure Attachment to
Threaded Hole



10-22

Pipe Rod Stiffener



10-22

Strut Rod Stiffener



10-22

nVent CADDY Quick Clip
Rod Stiffener

METAL FRAMING



11-2

Strut Channel Type A,
Slotted



11-3

Strut Channel Type AA,
Slotted



11-3

Strut Channel Type AS,
Perforated

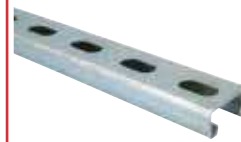

11-4

Strut Channel Type C,
Slotted



11-5

Strut Channel Type CC,
Slotted



11-5

Strut Channel Type D,
Slotted



11-6

Strut Channel Type DD,
Slotted



11-6

Strut Channel Type E,
Slotted



11-6

Strut Channel Type EE,
Slotted



11-7

Strut to Strut Connector

Picture Reference

METAL FRAMING

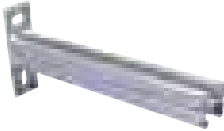
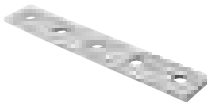
				
11-7 ADK Strut End Cap	11-7 Strut Channel Cover	11-8 Quick Strut Nut	11-8 Quick Strut Nut with Stud	11-9 Strut Nut without Spring
				
11-10 Strut Nut with Spring, Channel Type A	11-11 Strut Nut with Spring, Channel Type C	11-12 Strut T-Bolt	11-13 Clip-On Strut Nut	11-14 Strut Cantilever Arm Type A, Slotted
				
11-15 Strut Cantilever Arm Type AA, Slotted	11-15 Strut Cantilever Arm Type C, Slotted	11-16 Strut Cantilever Arm Type CC, Slotted	11-16 CTRI Cantilever Arm for Cable Tray	11-17 Internal Channel Washer
				
11-17 Saddle Washer	11-17 Square Channel Washer	11-18 Two Hole Flat Bracket	11-18 Three Hole Flat Adjustable Swivel Bracket	11-18 Three Hole Flat Bracket
				
11-19 Three Hole Flat Corner Bracket	11-19 Four Hole Flat Bracket	11-20 Four Hole Flat Gusset Tee Bracket	11-20 Four Hole Flat Tee Plate	11-20 Five Hole Flat Bracket

Picture Reference

METAL FRAMING

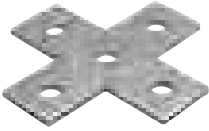

11-21

Five Hole Flat Cross Bracket



11-21

1-1 Hole Angle Bracket



11-22

1-1 Hole Closed Corner Angle Bracket



11-22

1-1 Hole Open Corner Angle Bracket

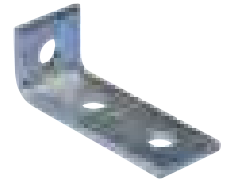

11-22

1-2 Hole Corner Angle Bracket

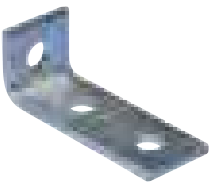

11-23

1-2 Hole Corner Short Angle Bracket



11-23

1-2 Hole Offset Corner Angle Bracket, Left



11-23

1-2 Hole Offset Corner Angle Bracket, Right



11-24

1-3 Hole Offset Corner Angle Bracket, Left



11-24

1-3 Hole Offset Corner Angle Bracket, Right



11-24

1-3 Hole Corner Angle Bracket



11-25

2-2 Hole Corner Angle Bracket



11-25

2-2 Hole Corner 90° Angle Bracket



11-25

2-2 Hole In-Line Corner 90° Angle Bracket



11-26

3-1 Hole In-Line Corner 90° Angle Bracket



11-26

2-2 Hole Corner Gusset



11-26

2-2 Hole Open Corner Angle Bracket



11-27

1-1 Hole 45° Angle Brace



11-27

Six Hole Special Corner Connector, 3-Way



11-27

Six Hole Double Corner Connector, 3-Way



11-28

Eight Hole Double Corner Connector, 3-Way

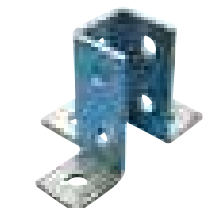

11-28

Nine Hole Corner Connector, 3-Way

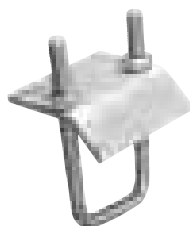

11-29

Strut Beam Clamp with U-Bolt



11-29

Strut Beam Clip



11-30

Strut Beam Clamp with Bolt, Window Shape

Picture Reference

METAL FRAMING



11-30

External Side Strut Beam Clamp



11-30

Internal Strut Beam Clamp with Bolt



11-31

Strut and Rod Beam Clamp

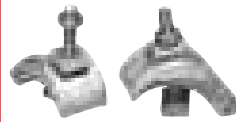

11-31

Heavy Duty Strut Beam Clamp

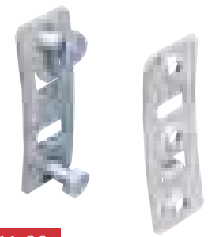

11-32

INC8 Internal Strut Beam Clamp

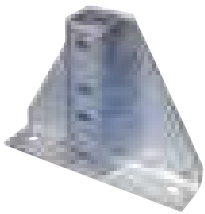

11-32

High Post Base for Strut Type A with Gusset



11-32

Open Post Base for Strut Type A with Gusset

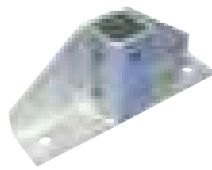

11-33

Post Base for Strut Type A with Gusset

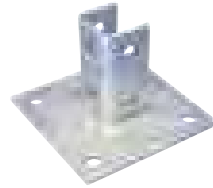

11-33

Post Base for Strut Type A

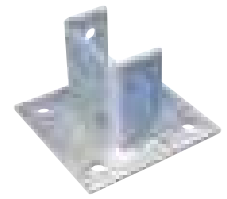

11-33

Post Base for Strut Type AA



11-34

45° Post Base for Strut Type AA



11-34

Rectangular Post Base Plate



11-34

Low Post Base for Strut Types AA/E

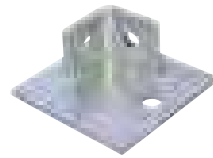

11-35

Post Base Plate, 1-1 Hole Angle



11-35

Post Base Plate, 1-1 Hole Angle Corner

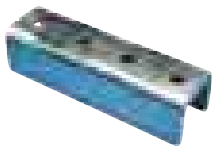

11-35

Four Hole External Coupler

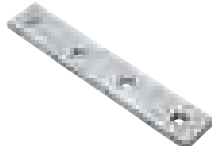

11-36

Internal Channel Connector

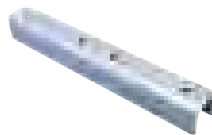

11-36

Internal U-Shaped Coupler



11-36

Swivel Post Base Bracket for Strut Type A



11-37

Swivel Attachment for Strut Type AS



11-37

2-2 Hole Adjustable Strut Swivel Bracket



11-37

1-1 Hole Swivel Bracket

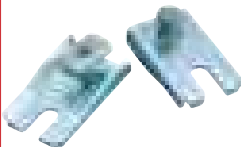

11-38

Strut Trapeze Attachment Plate



11-38

U-Shaped Bracket for Strut Type A



11-38

U-Shaped Bracket for Strut Types AA/E

Picture Reference

METAL FRAMING

 <p>11-39 U-Shaped Bracket for Strut Types AA/E, Back-to-Back</p>	 <p>11-39 U-Shaped Bracket for Strut Type C</p>	 <p>11-39 Z-Shaped Bracket for Strut Type A</p>	 <p>11-40 Z-Shaped Bracket for Strut Type AA/E</p>	 <p>11-40 Z-Shaped Bracket for Strut Type C</p>
 <p>11-40 Z-Shaped Offset Bracket for Strut Type A</p>	 <p>11-41 ESC Strut Attachment Clip</p>	 <p>11-41 C-Channel Type E0L, Perforated</p>	 <p>11-41 C-Channel Type E0, Perforated</p>	 <p>11-41 C-Channel Type E1, Perforated</p>
 <p>11-42 C-Channel Type E2L, Perforated</p>	 <p>11-42 C-Channel Type E3, Perforated</p>	 <p>11-43 C-Channel Type E4, Perforated</p>	 <p>11-43 C-Channel Type E5, Perforated</p>	 <p>11-44 ADK Plastic End Cap for C-Channel</p>
 <p>11-44 C-FIX Nut/Washer</p>	 <p>11-45 C-FIX M T-Bolt</p>	 <p>11-45 KP T-Bolt for C-Channel E0/E0L/E1</p>	 <p>11-46 KP T-Bolt for C-Channel E2/E2L/E3</p>	 <p>11-46 KP T-Bolt for C-Channel E4</p>
 <p>11-46 ECN Universal Nut</p>	 <p>11-47 ECN Nut for C-Channel E0/E0L/E1</p>	 <p>11-47 ECN Nut for C-Channel E2/E2L/E3</p>	 <p>11-47 ECN Nut for C-Channel E4</p>	 <p>11-48 ECN Nut for C-Channel E5</p>

Picture Reference

METAL FRAMING

				
11-48 ECN Square Nut for C-Channel E5	11-49 Cantilever Arm with E0L Channel	11-49 Cantilever Arm with E0 Channel	11-50 Cantilever Arm with E2 Channel	11-50 Cantilever Arm with E3 Channel
				
11-51 Cantilever Arm with E4 Channel	11-51 Cantilever Arm with E4 Channel and Brace	11-52 Brace Arm for E4 Channel	11-52 C-Channel U-Shaped Washer	11-52 C-Channel 1-1 Slot Angle Bracket
				
11-53 C-Channel 2-2 Slot Angle Bracket	11-53 C-Channel 2-2 Slot Open Corner Angle Bracket	11-54 C-Channel Beam Clamp	11-54 C-Channel Beam Clamp with U-Bolt	11-54 C-Channel Horizontal Wall Bracket
				
11-55 C-Channel Vertical Wall Bracket	11-55 C-Channel Adjustable Corner Bracket	11-55 C-Channel Coupler, Type E3	11-56 U-Channel Type UC, Perforated	11-56 2000 U-Channel
				
11-57 3000 U-Channel	11-57 U-Channel Cantilever Arm, Perforated with Brace	11-58 2000 U-Channel Beam Clamp	11-58 3000 U-Channel Beam Clamp	11-59 Telescoping Strut Replacement, No Nut

Picture Reference

METAL FRAMING

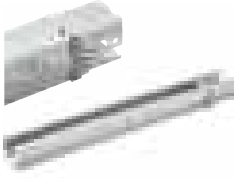

11-59

Telescoping Strut Replacement, Retrofit

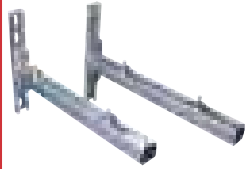

11-60

Universal Support Kit

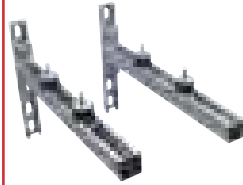

11-60

Universal Support Kit with Sound Insulators



11-61

Rubber Profile for Strut Channel



11-61

Rubber Profile for C-Channel



11-62

APX External Vertical Wall Bracket

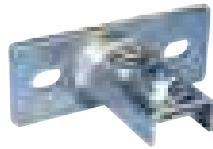

11-62

APY External Horizontal Wall Bracket



CONNECT AND PROTECT

Doing Work the Right Way for More Than 60 Years

Since 1956, contractors, architects, engineers and distributors have trusted nVent CADDY for quality fixing, fastening and hanging products. The nVent CADDY team treats you like family, so you trust us like family. nVent CADDY is there for customers through every step of the job, from design to installation to inspection.

Trust nVent CADDY for applications including electrical, mechanical, seismic, fire protection, datacom and more.

nVent.com/CADDY

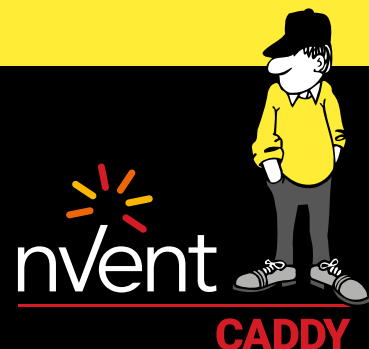

CADDY ERICO HOFFMAN RAYCHEM SCHROFF TRACER

1. Cable/Conduit



Cable/Conduit

BEAM

BC200-CD CONDUIT TO BEAM CLAMP

- Eliminates offset bending conduit
- Threaded hole on back
- Ideal for electrical, mechanical, and HVAC applications

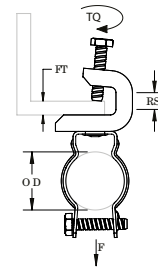

Material: Steel
Finish: Electrogalvanized



Part Number	Article Number	Outer Diameter	Flange Thickness	Rod Size	Torque	Static Load	Certifications
BC200CD1B	182220	19 – 25 mm	16 mm Max	M6	4 N-m	440 N	cULus, ITB
BC200CD2B	182230	25 – 33 mm	16 mm Max	M6	4 N-m	440 N	cULus

EM-P CONDUIT TO FLANGE CLIP

- Requires only a hammer to install
- Available for EMT, rigid, IMT and aluminum conduit
- Will pivot through 360°

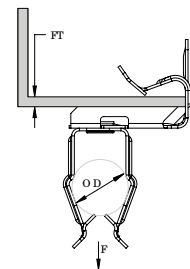

Material: Spring Steel
Finish: nVent CADDY Armour

Part Number	Article Number	Outer Diameter	Flange Thickness	Ultimate Static Load	Certifications
8P24	172150	18 – 22 mm	3 – 8 mm	110 N	ITB
8P58	172160	18 – 22 mm	8 – 14 mm	110 N	ITB
8P912	175100	18 – 22 mm	14 – 20 mm	110 N	ITB
12P24	175110	22 – 30 mm	3 – 8 mm	110 N	
12P58	175120	22 – 30 mm	8 – 14 mm	110 N	
12P912	175130	22 – 30 mm	14 – 20 mm	110 N	
16P24	175140	30 – 35 mm	3 – 8 mm	110 N	
16P58	175150	30 – 35 mm	8 – 14 mm	110 N	
16P912	175160	30 – 35 mm	14 – 20 mm	110 N	

Cable/Conduit

BEAM

H-PSM CONDUIT TO FLANGE CLIP, SIDE MOUNT

- Requires only a hammer to install
- Available for EMT, rigid and aluminum conduit
- Will pivot through 360°

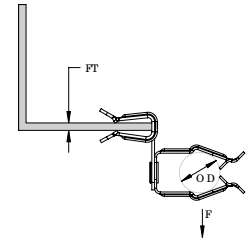
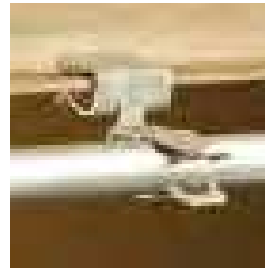

Orientation: Side Mount
Material: Spring Steel
Finish: nVent CADDY Armour

Part Number	Article Number	Outer Diameter	Flange Thickness	Ultimate Static Load
8P4SM	175170	18 – 22 mm	2 – 3 mm	111 N
8P24SM	175180	18 – 22 mm	3 – 8 mm	111 N
8P58SM	175190	18 – 22 mm	8 – 14 mm	111 N
8P912SM	175200	18 – 22 mm	14 – 20 mm	111 N
12P4SM	175210	22 – 30 mm	2 – 3 mm	111 N
12P24SM	175220	22 – 30 mm	3 – 8 mm	111 N
12P58SM	175230	22 – 30 mm	8 – 14 mm	111 N
12P912SM	175240	22 – 30 mm	14 – 20 mm	111 N
16P4SM	175250	30 – 35 mm	2 – 3 mm	111 N
16P24SM	175260	30 – 35 mm	3 – 8 mm	111 N
16P58SM	175270	30 – 35 mm	8 – 14 mm	111 N
16P912SM	175280	30 – 35 mm	14 – 20 mm	111 N

H-PIN CONDUIT TO FLANGE CLIP

- Supports conduit from beam
- Requires only a hammer to install

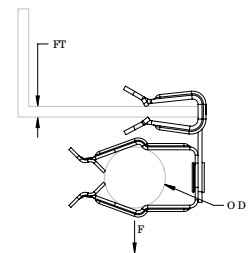

Material: Spring Steel
Finish: nVent CADDY Armour

Part Number	Article Number	Outer Diameter	Flange Thickness	Ultimate Static Load
8P24IN	175300	18 – 22 mm	3 – 8 mm	110 N
8P58IN	175310	18 – 22 mm	8 – 14 mm	110 N
12P4IN	175320	22 – 30 mm	2 – 3 mm	110 N

Cable/Conduit

BEAM

EM-M CONDUIT/PIPE TO FLANGE CLIP

- Supports conduit/pipe or cable from beam flanges
- Snap close clip pivots a full 360°
- Requires only a hammer to install

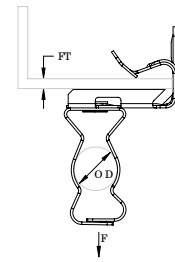
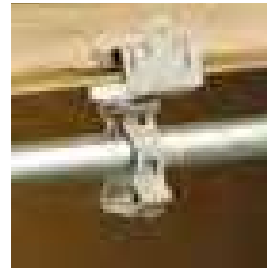

Part Number	Article Number	Outer Diameter	Flange Thickness	Static Load	Certifications
Material: Spring Steel – Finish: nVent CADDY Armour					
6EM24	173550	14 – 18 mm	3 – 8 mm	330 N	
6EM58	171750	14 – 18 mm	8 – 14 mm	330 N	
812EM24	160120	18 – 30 mm	3 – 8 mm	330 N	ITB
812EM58	160130	18 – 30 mm	8 – 14 mm	330 N	ITB
812EM912	160140	18 – 30 mm	14 – 20 mm	330 N	ITB
812EM1318	160075	18 – 30 mm	21 – 28 mm	330 N	cULus
16EM24	171740	30 – 35 mm	3 – 8 mm	330 N	ITB
16EM58	171490	30 – 35 mm	8 – 14 mm	330 N	ITB
16EM912	173570	30 – 35 mm	14 – 20 mm	330 N	ITB
16EM1318	173745	30 – 35 mm	21 – 28 mm	330 N	cULus
20EM24	171800	35 – 42 mm	3 – 8 mm	330 N	ITB
20EM58	171950	35 – 42 mm	8 – 14 mm	330 N	ITB
20EM912	173580	35 – 42 mm	14 – 20 mm	330 N	ITB
24EM24	171960	42 – 50 mm	3 – 8 mm	330 N	ITB
24EM58	171970	42 – 50 mm	8 – 14 mm	330 N	ITB
24EM912	173590	42 – 50 mm	14 – 20 mm	330 N	ITB
32EM24	173600	50 – 60 mm	3 – 8 mm	330 N	ITB
32EM58	173610	50 – 60 mm	8 – 14 mm	330 N	ITB
32EM912	173620	50 – 60 mm	14 – 20 mm	330 N	ITB
Material: Stainless Steel 301 (EN 1.4310)					
8EM24S1	179780	18 – 22 mm	3 – 8 mm	200 N	
8EM58S1	179790	18 – 22 mm	8 – 14 mm	200 N	
8EM912S1	179800	18 – 22 mm	14 – 20 mm	200 N	
12EM58S1	179820	22 – 30 mm	8 – 14 mm	200 N	
12EM912S1	179830	22 – 30 mm	14 – 20 mm	200 N	

Cable/Conduit

BEAM

H-MSM CONDUIT/PIPE TO FLANGE CLIP, SIDE MOUNT

- Supports conduit/pipe or cable from beam flanges
- Snap close clip pivots a full 360°
- Requires only a hammer to install

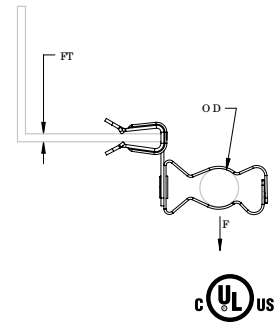
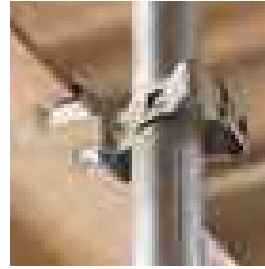

Part Number	Article Number	Outer Diameter	Flange Thickness	Static Load	Certifications
Material: Spring Steel – Finish: nVent CADDY Armour					
6M24SM	173640	14 – 18 mm	3 – 8 mm	120 N	cULus
6M58SM	171980	14 – 18 mm	8 – 14 mm	120 N	cULus
6M912SM	173650	14 – 18 mm	14 – 20 mm	120 N	
812M24SM	160050	18 – 30 mm	3 – 8 mm	120 N	cULus, ITB
812M58SM	160060	18 – 30 mm	8 – 14 mm	120 N	cULus, ITB
812M912SM	160070	18 – 30 mm	14 – 20 mm	120 N	cULus, ITB
812M1318SM	160145	18 – 30 mm	21 – 28 mm	120 N	cULus
16M24SM	173720	30 – 35 mm	3 – 8 mm	120 N	cULus
16M58SM	173730	30 – 35 mm	8 – 14 mm	120 N	cULus
16M912SM	173740	30 – 35 mm	14 – 20 mm	120 N	cULus
20M24SM	171720	35 – 42 mm	3 – 8 mm	120 N	cULus
20M58SM	173770	35 – 42 mm	8 – 14 mm	120 N	
20M912SM	173780	35 – 42 mm	14 – 20 mm	120 N	
24M4SM	173790	42 – 50 mm	2 – 3 mm	120 N	
24M24SM	176690	42 – 50 mm	3 – 8 mm	120 N	cULus
24M58SM	173800	42 – 50 mm	8 – 14 mm	120 N	cULus
24M912SM	173810	42 – 50 mm	14 – 20 mm	120 N	cULus
32M24SM	173830	50 – 60 mm	3 – 8 mm	120 N	cULus
32M58SM	173840	50 – 60 mm	8 – 14 mm	120 N	cULus
Material: Stainless Steel 301 (EN 1.4310)					
8M24SMS1	179650	18 – 22 mm	3 – 8 mm	90 N	
8M58SMS1	179660	18 – 22 mm	8 – 14 mm	90 N	
8M912SMS1	179670	18 – 22 mm	14 – 20 mm	90 N	
12M24SMS1	179690	22 – 30 mm	3 – 8 mm	90 N	
12M58SMS1	179700	22 – 30 mm	8 – 14 mm	90 N	

Cable/Conduit

BEAM

BC-M CONDUIT TO BEAM CLAMP

- Easy installation to beam flanges
- Eliminates offset bending conduit
- Conduit clip rotates 360°

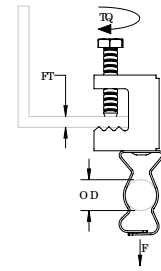

Material: Spring Steel
Finish: nVent CADDY Armour

Part Number	Article Number	Outer Diameter	Flange Thickness	Torque	Static Load	Certifications
EBC6M	172580	14 – 18 mm	16 mm Max	3 N-m	450 N	
EBC812M	160200	18 – 30 mm	16 mm Max	3 N-m	450 N	ITB
EBC16M	172590	30 – 35 mm	16 mm Max	3 N-m	450 N	ITB
EBC20M	172600	35 – 42 mm	16 mm Max	3 N-m	450 N	ITB
EBC24M	172610	42 – 50 mm	16 mm Max	3 N-m	450 N	ITB
EBC32M	172620	50 – 60 mm	16 mm Max	3 N-m	450 N	ITB

BC-MSM CONDUIT TO BEAM CLAMP, SIDE MOUNT

- Easy installation to beam flanges
- Eliminates offset bending conduit
- Conduit clip rotates 360°

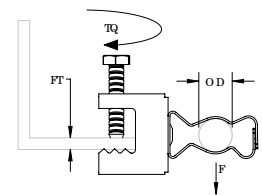

Material: Spring Steel
Finish: nVent CADDY Armour

Part Number	Article Number	Outer Diameter	Flange Thickness	Torque	Static Load	Certifications
EBC6MSM	172650	14 – 18 mm	16 mm Max	3 N-m	110 N	
EBC812MSM	160180	18 – 30 mm	16 mm Max	3 N-m	110 N	ITB
EBC16MSM	172660	30 – 35 mm	16 mm Max	3 N-m	110 N	ITB
EBC20MSM	172670	35 – 42 mm	16 mm Max	3 N-m	110 N	ITB
EBC24MSM	172680	42 – 50 mm	16 mm Max	3 N-m	110 N	ITB
EBC32MSM	172690	50 – 60 mm	16 mm Max	3 N-m	110 N	ITB

Cable/Conduit

BEAM

HK CABLE SNAP CLIP

- Provides support for low voltage cables
- Attaches easily to beam

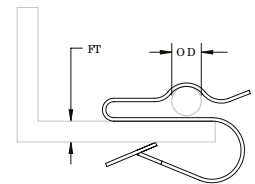

Material: Steel
Finish: Electrogalvanized

Part Number	Article Number	Flange Thickness	Outer Diameter
HK25	187440	1.5 – 4.5 mm	4.2 – 6.5 mm
HK48	187450	4.0 – 8.0 mm	4.2 – 6.5 mm
HK811	187460	8.0 – 11.0 mm	4.2 – 6.5 mm

HSC HOLE SNAP CLIP

- Supports cable to decking
- Snap clip that attaches to decking
- Mounts in two different orientations
- Fits in any 6 mm or greater hole

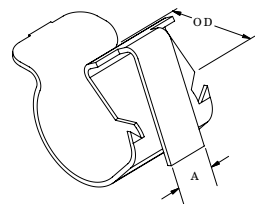

Material: Spring Steel
Finish: nVent CADDY Armour

Part Number	Article Number	Outer Diameter	A
HSC67	186000	6 – 7 mm	6 mm
HSC78	187740	7 – 8 mm	6 mm
HSC89	186010	8 – 9 mm	6 mm
HSC910	187780	9 – 10 mm	6 mm
HSC1011	186020	10 – 11 mm	6 mm
HSC1214	186030	12 – 14 mm	6 mm
HSC1518	186040	15 – 18 mm	6 mm
HSC1924	186050	19 – 24 mm	6 mm
HSC2532	186060	25 – 32 mm	6 mm

Cable/Conduit

BEAM

LB3B CABLE SNAP CLIP

- Attaches multiple cable runs to beam or joist

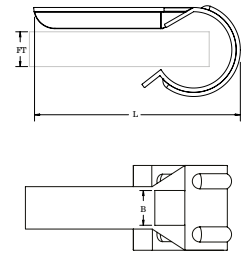

Material: Steel
Finish: Electrogalvanized

Part Number	Article Number	Flange Thickness	Length	B
-------------	----------------	------------------	--------	---

LB3B	187390	12 – 20 mm	52 mm	8 mm Max
------	--------	------------	-------	----------

Cable tie not supplied with clip.

LF2/LF3 CABLE SNAP CLIP

- Supports up to two runs of cables
- Attaches easily to beam or joist

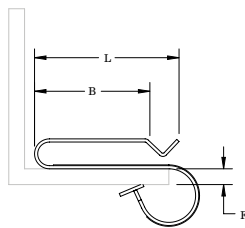
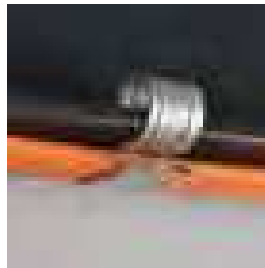

Material: Steel
Finish: Electrogalvanized

Part Number	Article Number	Flange Thickness	Length	B
-------------	----------------	------------------	--------	---

LF2	187400	5 – 12 mm	45 mm	35 mm
LF3	187410	12 – 20 mm	53 mm	35 mm

LF5 CABLE SNAP CLIP

- Supports single run of cable
- Attaches easily to beam or joist

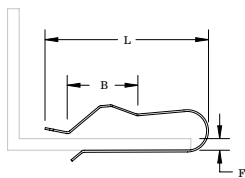

Material: Steel
Finish: Electrogalvanized

Part Number	Article Number	Flange Thickness	Length	B
-------------	----------------	------------------	--------	---

LF5	187430	6 – 12 mm	49 mm	18 mm
-----	--------	-----------	-------	-------

Cable/Conduit

BEAM

LR CABLE SNAP CLIP

- Supports single run of cable
- Attaches easily to beam or joist

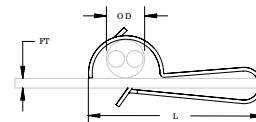

Material: Steel
Finish: Electrogalvanized

Part Number	Article Number	Flange Thickness	Outer Diameter	Length
LR1	187370	3 – 6 mm	8 – 15 mm	36 mm
LR2	187380	6 – 12 mm	8 – 15 mm	36 mm

SOLAR SNAP CLIP

- Supports up to two transmission cables on solar arrays
- Mounts in four orientations
- Flared edges to protect cable
- Gripping tab provides a secure fit to the frame

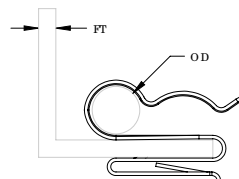

Material: Spring Steel
Finish: nVent CADDY Armour

Part Number	Article Number	Flange Thickness	Outer Diameter
SCSOL1A	187781	1.5 – 2.0 mm	5 – 7 mm

Cable/Conduit

BEAM

SC CABLE SNAP CLIP

- Easily supports cable from flanges
- Requires only a hammer to install

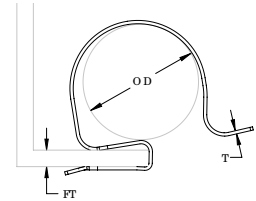
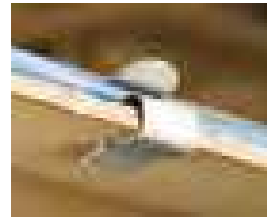

Material: Spring Steel
Finish: nVent CADDY Armour

Part Number	Article Number	Flange Thickness	Outer Diameter	Thickness	Standard Packaging Quantity
24SC67	187510	2 – 4 mm	6 – 7 mm	0.6 mm	100 pc
24SC78	187710	2 – 4 mm	7 – 8 mm	0.6 mm	100 pc
24SC89	187530	2 – 4 mm	8 – 9 mm	0.6 mm	100 pc
24SC910	187750	2 – 4 mm	9 – 10 mm	0.6 mm	100 pc
24SC1011	187550	2 – 4 mm	10 – 11 mm	0.6 mm	100 pc
24SC1214	187570	2 – 4 mm	12 – 14 mm	0.6 mm	100 pc
24SC1518	187590	2 – 4 mm	15 – 18 mm	0.6 mm	100 pc
24SC1518R25	191003	2 – 4 mm	15 – 18 mm	0.6 mm	4 x 25 pc
24SC1924	187610	2 – 4 mm	19 – 24 mm	0.6 mm	100 pc
24SC1924R25	191004	2 – 4 mm	19 – 24 mm	0.6 mm	4 x 25 pc
24SC2530	187630	2 – 4 mm	25 – 32 mm	0.6 mm	100 pc
24SC2530R25	191005	2 – 4 mm	25 – 32 mm	0.6 mm	4 x 25 pc
47SC67	187500	4 – 7 mm	6 – 7 mm	0.6 mm	100 pc
47SC78	187720	4 – 7 mm	7 – 8 mm	0.6 mm	100 pc
47SC89	187520	4 – 7 mm	8 – 9 mm	0.6 mm	100 pc
47SC910	187760	4 – 7 mm	9 – 10 mm	0.6 mm	100 pc
47SC1011	187540	4 – 7 mm	10 – 11 mm	0.6 mm	100 pc
47SC1214	187560	4 – 7 mm	12 – 14 mm	0.6 mm	100 pc
47SC1518	187580	4 – 7 mm	15 – 18 mm	0.6 mm	100 pc
47SC1518R25	191009	4 – 7 mm	15 – 18 mm	0.6 mm	4 x 25 pc
47SC1924	187600	4 – 7 mm	19 – 24 mm	0.6 mm	100 pc
47SC1924R25	191010	4 – 7 mm	19 – 24 mm	0.6 mm	4 x 25 pc
47SC2530	187620	4 – 7 mm	25 – 32 mm	0.6 mm	100 pc
47SC2530R25	191011	4 – 7 mm	25 – 32 mm	0.6 mm	4 x 25 pc
812SC67	187640	8 – 12 mm	6 – 7 mm	0.6 mm	100 pc
812SC78	187730	8 – 12 mm	7 – 8 mm	0.6 mm	100 pc
812SC89	187650	8 – 12 mm	8 – 9 mm	0.6 mm	100 pc
812SC910	187770	8 – 12 mm	9 – 10 mm	0.6 mm	100 pc
812SC1011	187660	8 – 12 mm	10 – 11 mm	0.6 mm	100 pc
812SC1214	187670	8 – 12 mm	12 – 14 mm	0.6 mm	100 pc
812SC1518	187680	8 – 12 mm	15 – 18 mm	0.6 mm	100 pc
812SC1518R25	191015	8 – 12 mm	15 – 18 mm	0.6 mm	4 x 25 pc
812SC1924	187690	8 – 12 mm	19 – 24 mm	0.6 mm	100 pc
812SC1924R25	191016	8 – 12 mm	19 – 24 mm	0.6 mm	4 x 25 pc
812SC2530	187700	8 – 12 mm	25 – 32 mm	0.6 mm	100 pc
812SC2530R25	191017	8 – 12 mm	25 – 32 mm	0.6 mm	4 x 25 pc

Cable/Conduit

BEAM

SCA CABLE SNAP CLIP ADAPTOR

- Use with 24SC series snap clips to accommodate thicker flanges
- Supports up to three snap clips
- Requires only a hammer to install

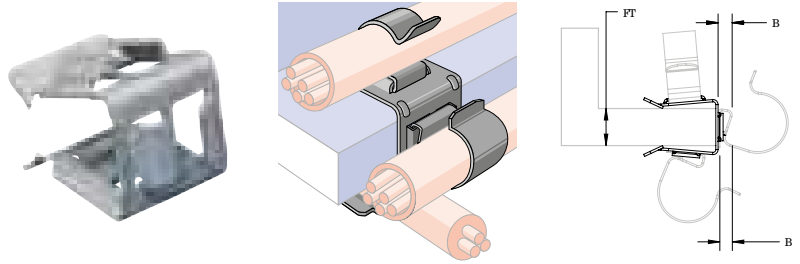

Material: Spring Steel
Finish: nVent CADDY Armour

Part Number	Article Number	Flange Thickness	B
SCA	160510	13 – 20 mm	2 – 4 mm

SCB CABLE SNAP CLIP ADAPTOR

- Allows for parallel cable runs along the inboard of the flange
- Use with 24SC series snap clips to accommodate thicker flanges
- Supports up to three snap clips
- Requires only a hammer to install



Material: Spring Steel
Finish: nVent CADDY Armour

Part Number	Article Number	Flange Thickness	B
SCB312	188080	3 – 12 mm	2 – 4 mm
SCB1220	188090	12 – 20 mm	2 – 4 mm

SCD DOVETAIL MOUNT CABLE SNAP CLIP ADAPTOR

- Adaptor to fix up to two 24SC snap clips to a dovetail deck
- Provides support for low voltage cables

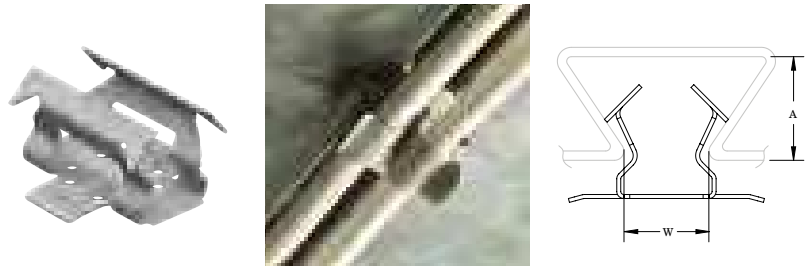

Material: Spring Steel
Finish: nVent CADDY Armour

Part Number	Article Number	Width	A
SCD1217	188170	12 – 17 mm	14 mm Min
SCD1722	188180	17 – 22 mm	14 mm Min

Cable/Conduit

BEAM

CABLE TIE WITH FLANGE CLIP

- Used to support cables from beam flanges
- Requires only a hammer to install

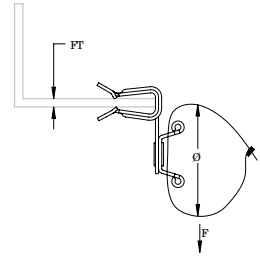

Part Number	Article Number	Flange Thickness	Cable Tie	Diameter	Static Load	Certifications	Standard Packaging Quantity
Material: Spring Steel – Finish: nVent CADDY Armour							
2H4CTBB	170210	2 – 3 mm	Nylon Black	10 – 70 mm	150 N	ITB	100 pc
2H4CTBW	170170	2 – 3 mm	Nylon White	10 – 70 mm	150 N	ITB	100 pc
4H24CTBB	170220	3 – 8 mm	Nylon Black	10 – 70 mm	150 N	ITB	100 pc
4H24CTBW	170180	3 – 8 mm	Nylon White	10 – 70 mm	150 N	ITB	100 pc
4H58CTBB	170240	8 – 14 mm	Nylon Black	10 – 70 mm	150 N	ITB	100 pc
4H58CTBW	170190	8 – 14 mm	Nylon White	10 – 70 mm	150 N	ITB	100 pc
4H912CTBB	170260	14 – 20 mm	Nylon Black	10 – 70 mm	150 N	ITB	100 pc
4H912CTBW	170200	14 – 20 mm	Nylon White	10 – 70 mm	150 N	ITB	100 pc
Material: Stainless Steel 301 (EN 1.4310)							
4H24CTBRS1	170280	3 – 8 mm	Stainless Steel 302 (EN 1.4324)	25 – 51 mm	300 N		100 pc
4H58CTBRS1	170300	8 – 14 mm	Stainless Steel 302 (EN 1.4324)	25 – 51 mm	300 N		100 pc
4H912CTBRS1	170310	14 – 20 mm	Stainless Steel 302 (EN 1.4324)	25 – 51 mm	300 N		100 pc

Cable/Conduit

BEAM

CABLE TIE HOLDER WITH FLANGE CLIP

- Used to support cables from beam flanges
- Requires only a hammer to install

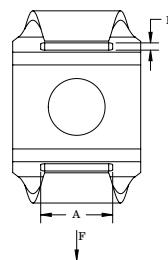
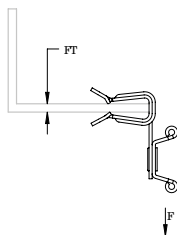
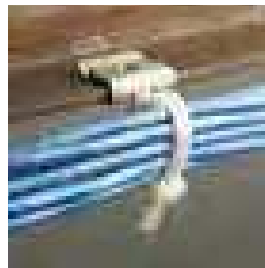

Part Number	Article Number	Flange Thickness	A	B	Static Load	Certifications	Standard Packaging Quantity
Material: Spring Steel – Finish: nVent CADDY Armour							
2H4CT	178510	2 – 3 mm	9 mm	2 mm	150 N	ITB	100 pc
4H24CT	178520	3 – 8 mm	9 mm	2 mm	150 N	ITB	100 pc
4H24CTR5	191021	3 – 8 mm	9 mm	2 mm	150 N		10 x 5 pc
4H58CT	178530	8 – 14 mm	9 mm	2 mm	150 N	ITB	100 pc
4H58CTR5	191022	8 – 14 mm	9 mm	2 mm	150 N		10 x 5 pc
4H58CTSP25	172360	8 – 14 mm	9 mm	2 mm	150 N		10 x 25 pc
4H912CT	178540	14 – 20 mm	9 mm	2 mm	150 N	ITB	100 pc
4H912CTR5	191023	14 – 20 mm	9 mm	2 mm	150 N		10 x 5 pc
4H912CTSP25	172390	14 – 20 mm	9 mm	2 mm	150 N		10 x 25 pc
4H1318CT	178545	21 – 28 mm	9 mm	2 mm	150 N		100 pc
Material: Stainless Steel 301 (EN 1.4310)							
4H24CTS1	160500	3 – 8 mm	9 mm	2 mm	150 N		100 pc
4H58CTS1	170430	8 – 14 mm	9 mm	2 mm	150 N		100 pc
4H912CTS1	170700	14 – 20 mm	9 mm	2 mm	150 N		100 pc

Cable/Conduit

BEAM

CABLE TIE HOLDER WITH INVERTED FLANGE CLIP

- Used to support cables from beam flanges
- Requires only a hammer to install
- Installed at the inside of the beam to avoid accidental rip-off

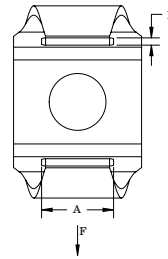
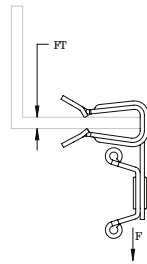

Material: Spring Steel
Finish: nVent CADDY Armour

Part Number	Article Number	Flange Thickness	A	B	Static Load
4H24CTIN	160470	3 – 8 mm	9 mm	2 mm	150 N
4H58CTIN	160480	8 – 14 mm	9 mm	2 mm	150 N
4H912CTIN	160490	14 – 20 mm	9 mm	2 mm	150 N

CABLE TO FLANGE CLIP

- Provides support for low voltage cables
- Requires only a hammer to install

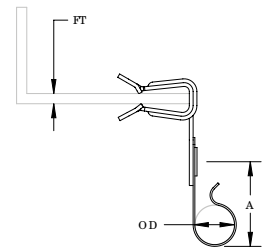

Material: Spring Steel
Finish: nVent CADDY Armour

Part Number	Article Number	Flange Thickness	Outer Diameter	A
2H41214A	170470	2 – 3 mm	12.4 – 16.0 mm	25 mm
4H241012A	170480	3 – 8 mm	10.9 – 13.0 mm	25 mm
4H241214A	170630	3 – 8 mm	12.4 – 16.0 mm	25 mm

Cable/Conduit

BEAM

DOUBLE CABLE TO FLANGE CLIP

- Provides support for low voltage cables
- Requires only a hammer to install

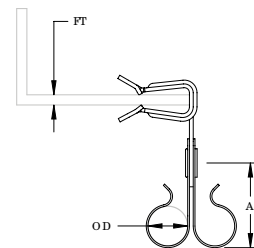
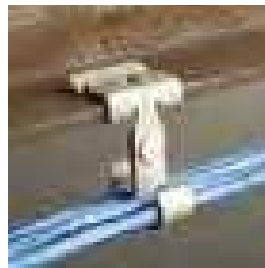

Material: Spring Steel
Finish: nVent CADDY Armour

Part Number	Article Number	Flange Thickness	Outer Diameter	A
2H41214B	170840	2 – 3 mm	12.4 – 16.0 mm	25 mm
4H241012B	170850	3 – 8 mm	10.9 – 13.0 mm	25 mm
4H241214B	170640	3 – 8 mm	12.4 – 16.0 mm	25 mm

CABLE RETAINER STRAP WITH FLANGE CLIP

- Fastens cables to top of flange
- Requires only a hammer to install

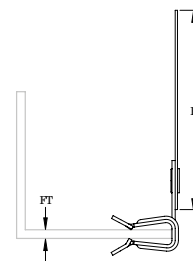
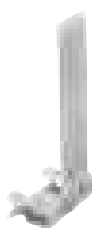

Part Number	Article Number	Flange Thickness	B	Standard Packaging Quantity
Material: Spring Steel – Finish: nVent CADDY Armour				
2H4ST3	173420	2 – 3 mm	69 mm	100 pc
4H24ST3	171500	3 – 8 mm	69 mm	100 pc
4H24ST3SP25	172340	3 – 8 mm	69 mm	10 x 25 pc
4H58ST3	171530	8 – 14 mm	69 mm	100 pc
4H58ST3SP25	172370	8 – 14 mm	69 mm	10 x 25 pc
4H912ST3	171640	14 – 20 mm	69 mm	100 pc
4H912ST3SP25	172400	14 – 20 mm	69 mm	10 x 25 pc
4H1318ST3	171775	21 – 28 mm	69 mm	100 pc

Cable/Conduit

DECK

SCD MULTI-CABLE TO DECK CLIP

- Provides support for low voltage cables
- Flared edges for cable protection
- Rotates 360° to support various directional runs of cable
- No tools required for installation

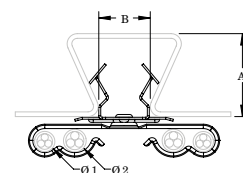
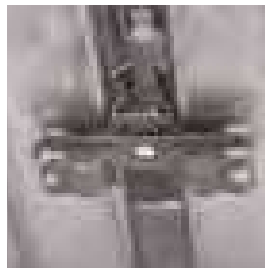

Material: Spring Steel
Finish: nVent CADDY Armour

Part Number	Article Number	Cable Capacity	Diameter 1	Diameter 2	A	B
SCD1217QSC	188175	4	7 – 8 mm	8 – 12 mm	14 mm Min	12 – 17 mm
SCD1722QSC	188185	4	7 – 8 mm	8 – 12 mm	14 mm Min	17 – 22 mm

J-CT CABLE TIE HOLDER WITH C PURLIN CLIP

- Used to support cables from C purlin
- Requires only a hammer to install

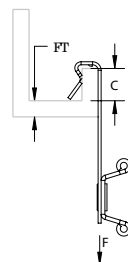
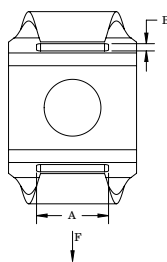

Material: Spring Steel
Finish: nVent CADDY Armour

Part Number	Article Number	Flange Thickness	Cable Tie	A	B	C	Static Load
J1CT	170610	1.5 – 4.0 mm	Not Included	9 mm	2 mm	10 mm Min	150 N
J2CT	170350	4.0 – 6.5 mm	Not Included	9 mm	2 mm	10 mm Min	150 N

Cable/Conduit

ROD/WIRE

CABLE/CONDUIT CLIP

- Supports conduit to rod, wire or flange
- Can also be used for flexible metallic tubing, armored cable, portable cables, control tubes and communications cable
- Available for EMT, rigid, ENT, IMT, MC/AC and aluminum conduit
- No installation tools required

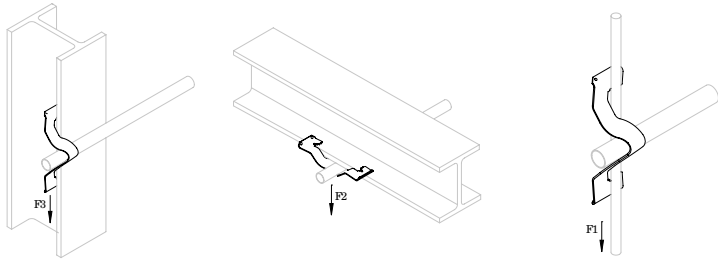
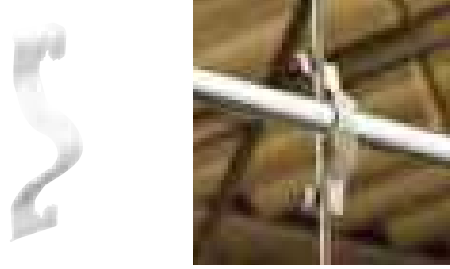

Material: Spring Steel
Finish: nVent CADDY Armour



Part Number	Article Number	Outer Diameter	Static Load 1	Static Load 2	Static Load 3	Certifications	Standard Packaging Quantity
K12	170670	24 mm Max	220 N	445 N	70 N	cULus, ITB	100 pc
K16	170680	30 mm Max	220 N	445 N	70 N	cULus, ITB	100 pc
K20	170690	42 mm Max	220 N	445 N	100 N	cULus, ITB	100 pc

For horizontal application only when installing conduit.

Part Number	Outer Diameter	Rod Size
K12	14 mm - 20 mm	M12
K12	16 mm - 22 mm	M8; M10
K12	18 mm - 24 mm	M4; M6
K16	22 mm - 24 mm	M12
K16	24 mm - 26 mm	M8; M10
K16	26 mm - 30 mm	M4; M6
K20	20 mm - 36 mm	M12
K20	25 mm - 38 mm	M8; M10
K20	30 mm - 42 mm	M4; M6

Part Number	Outer Diameter	Flange Thickness
K12	3 mm - 7 mm	16 mm - 22 mm
K12	8 mm - 10 mm	14 mm - 20 mm
K12	11 mm - 13 mm	12 mm - 19 mm
K16	3 mm - 7 mm	24 mm - 28 mm
K16	8 mm - 10 mm	20 mm - 26 mm
K16	11 mm - 13 mm	19 mm - 24 mm
K20	3 mm - 7 mm	28 mm - 40 mm
K20	8 mm - 10 mm	26 mm - 38 mm
K20	11 mm - 13 mm	21 mm - 35 mm

Cable/Conduit

ROD/WIRE

CABLE/CONDUIT TO WIRE CLIP

- Supports cable and conduit without bending drop wire
- Faster installation than traditional methods

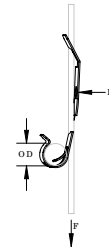
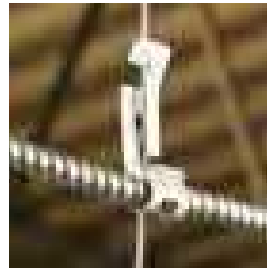

Material: Spring Steel
Finish: nVent CADDY Armour



Part Number	Article Number	Outer Diameter	Wire Size	Hole Size	Ultimate Static Load	Certifications
PCS1	170880	11 – 14 mm	2 – 4 mm	6.8 mm	110 N	cULus, ITB
PCS2	170881	15 – 23 mm	2 – 4 mm	6.8 mm	110 N	ITB

SNAP CLOSE CONDUIT TO ROD/WIRE CLIP

- Provides attachment of conduit and boxes

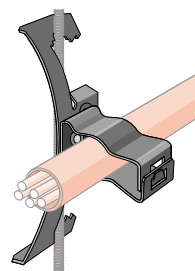

Material: Spring Steel
Finish: nVent CADDY Armour



Part Number	Article Number	Outer Diameter	Rod Size	Wire Size	Flange Thickness
4Z34812M	171060	18 – 30 mm	M4, M6, M8	4.8 mm	3.2 – 9.5 mm
6Z34812M	171090	18 – 30 mm	M10		9.5 – 11.1 mm

Cable/Conduit

CLAMPS AND CLIPS

PUSH IN CONDUIT CLAMP

- Push-in installation of conduit
- Eliminates need for offset bending conduit
- May be used for either vertical or horizontal installations

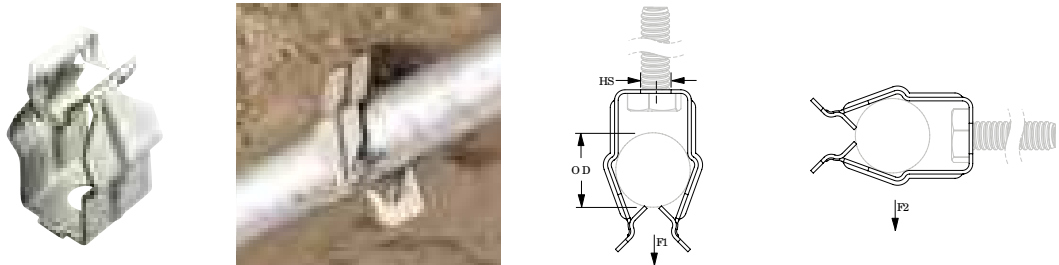

Material: Spring Steel
Finish: nVent CADDY Armour

Part Number	Article Number	Outer Diameter	Hole Size	Hole Type	Ultimate Static Load 1	Ultimate Static Load 2
8P	171130	18 – 22 mm	7 mm	Plain	110 N	65 N
12P	171150	22 – 30 mm	7 mm	Plain	110 N	65 N
16P	171170	30 – 35 mm	7 mm	Plain	110 N	65 N

SNAP CLOSE CONDUIT/PIPE CLAMP

- May be used for either vertical or horizontal installations
- Eliminates need for offset bending conduit
- Finger closure, no tools required

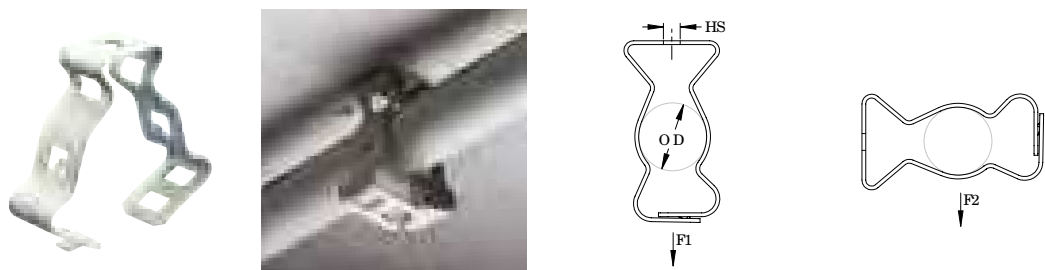

Part Number	Article Number	Outer Diameter	Hole Size	Hole Type	Static Load 1	Static Load 2	Certifications
Material: Spring Steel – Finish: nVent CADDY Armour							
6M	170790	14 – 18 mm	7 mm	Plain	440 N	110 N	cULus
812M	177130	18 – 30 mm	7 mm	Plain	440 N	110 N	cULus
16M	170100	30 – 35 mm	7 mm	Plain	440 N	110 N	cULus
20M	170110	35 – 42 mm	7 mm	Plain	440 N	110 N	cULus
24M	170120	42 – 50 mm	7 mm	Plain	440 N	110 N	cULus
32M	170130	50 – 60 mm	7 mm	Plain	440 N	110 N	cULus
Material: Stainless Steel 301 (EN 1.4310)							
8MS1	179900	18 – 22 mm	7 mm	Plain	440 N	110 N	
12MS1	179910	22 – 30 mm	7 mm	Plain	440 N	110 N	

Cable/Conduit

CLAMPS AND CLIPS

BOLT CLOSE CONDUIT/PIPE CLAMP

- Retained bolt and built-in nut means there are less parts to handle or drop
- Combo head bolt works with slotted, hex, #3 phillips or #2 robertson drivers

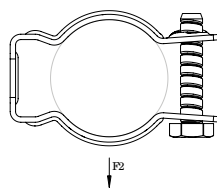
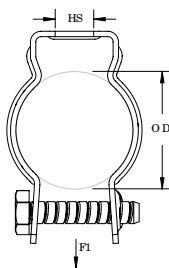
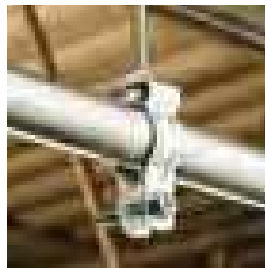

Material: Steel
 Finish: Electrogalvanized
 Nut Type: Built-In Nut



Part Number	Article Number	Outer Diameter	Hole Size	Static Load 1	Static Load 2	Certifications	Standard Packaging Quantity
CD1B	181190	19 – 25 mm	6.4 mm	880 N	220 N	cULus, ITB	100 pc

PUSH IN CONDUIT TO CONDUIT CLAMP

- Ideal as spacer between same or different size conduit
- No tools required for installation
- Top conduit to be used for support only, not a raceway

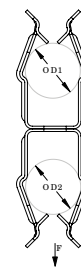
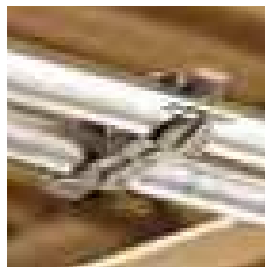

Material: Spring Steel
 Finish: nVent CADDY Armour

Part Number	Article Number	Outer Diameter 1	Outer Diameter 2	Ultimate Static Load
8P12P	171230	18 – 22 mm	22 – 30 mm	110 N
12P12P	171250	22 – 30 mm	22 – 30 mm	110 N
12P16P	171260	22 – 30 mm	30 – 35 mm	110 N
16P16P	171270	30 – 35 mm	30 – 35 mm	110 N

Cable/Conduit

CLAMPS AND CLIPS

WALL MOUNT CONDUIT CLIP

- Quickly attaches pipe, conduit, MC/AC and tube to wall surfaces
- Push-in installation of conduit
- Eliminates need for offset bending conduit
- Low-profile design minimizes snag potential
- Secure with powder-actuated tools, self-tapping concrete anchors or screw guns

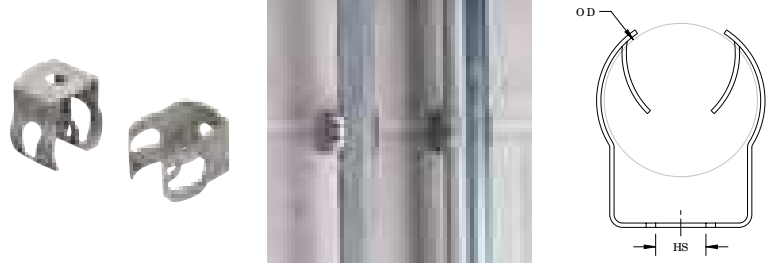

Material: Spring Steel
Finish: nVent CADDY Armour

Part Number	Article Number	Outer Diameter	Hole Size
WC812	160890	18 – 30 mm	7 mm

C-EC CABLE TO STRUT CLAMP

- One-piece cable/conduit clamp with protective boot
- No screws or bolts to drop
- Requires only a screwdriver or nutdriver for installation
- Fits into open side of strut channel

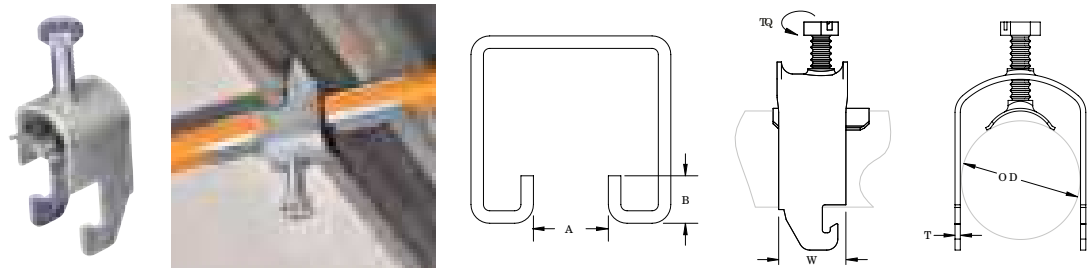

Material: Steel
Finish: Hot-Dip Galvanized

Part Number	Article Number	Outer Diameter	Torque	A	B
C12EC	337600	8 – 12 mm	2 N-m	18 mm Min	10 mm Max
C16EC	337610	12 – 16 mm	2 N-m	18 mm Min	10 mm Max
C20EC	337620	16 – 20 mm	2 N-m	18 mm Min	10 mm Max
C24EC	337630	20 – 24 mm	2 N-m	18 mm Min	10 mm Max
C28EC	337640	24 – 28 mm	2 N-m	18 mm Min	10 mm Max
C32EC	337650	28 – 32 mm	2 N-m	18 mm Min	10 mm Max
C36EC	337660	32 – 36 mm	2 N-m	18 mm Min	10 mm Max
C40EC	337670	36 – 40 mm	2 N-m	18 mm Min	10 mm Max
C44EC	337680	40 – 44 mm	4 N-m	18 mm Min	10 mm Max
C48EC	337690	44 – 48 mm	4 N-m	18 mm Min	10 mm Max
C52EC	337700	48 – 52 mm	4 N-m	18 mm Min	10 mm Max
C56EC	337710	52 – 56 mm	4 N-m	18 mm Min	10 mm Max
C60EC	337720	56 – 60 mm	4 N-m	18 mm Min	10 mm Max
C64EC	337730	60 – 64 mm	4 N-m	18 mm Min	10 mm Max
C70EC	337740	64 – 70 mm	4 N-m	18 mm Min	10 mm Max
C76EC	337750	70 – 76 mm	4 N-m	18 mm Min	10 mm Max
C82EC	337760	76 – 82 mm	4 N-m	18 mm Min	10 mm Max
C88EC	337770	82 – 88 mm	4 N-m	18 mm Min	10 mm Max
C94EC	337780	88 – 94 mm	4 N-m	18 mm Min	10 mm Max
C100EC	337790	94 – 100 mm	4 N-m	18 mm Min	10 mm Max

Screw is electrogalvanized on clamps that have an outer diameter of 40 mm or less.

Cable/Conduit

CLAMPS AND CLIPS

C-EU SINGLE CABLE TO FLANGE CLAMP

- Supports single run of conduit
- Attaches to beam flanges, angle iron, joists and other structural supports

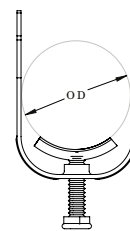
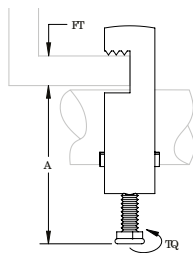
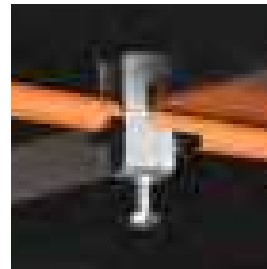

Material: Steel
Finish: Hot-Dip Galvanized

Part Number	Article Number	Outer Diameter	Flange Thickness	A	Torque
C12EU	337300	8 – 12 mm	12 mm Max	41 mm Max	2 N-m
C16EU	337310	12 – 16 mm	12 mm Max	46 mm Max	2 N-m
C20EU	337320	16 – 20 mm	12 mm Max	50 mm Max	2 N-m
C24EU	337330	20 – 24 mm	12 mm Max	54 mm Max	2 N-m
C28EU	337340	24 – 28 mm	12 mm Max	58 mm Max	2 N-m
C32EU	337350	28 – 32 mm	12 mm Max	63 mm Max	2 N-m
C36EU	337360	32 – 36 mm	12 mm Max	67 mm Max	2 N-m
C40EU	337370	36 – 40 mm	12 mm Max	71 mm Max	2 N-m
C44EU	337380	40 – 44 mm	12 mm Max	81 mm Max	4 N-m
C48EU	337390	44 – 48 mm	12 mm Max	85 mm Max	4 N-m
C52EU	337400	48 – 52 mm	12 mm Max	90 mm Max	4 N-m
C56EU	337410	52 – 56 mm	12 mm Max	94 mm Max	4 N-m
C60EU	337420	56 – 60 mm	12 mm Max	98 mm Max	4 N-m
C64EU	337430	60 – 64 mm	12 mm Max	102 mm Max	4 N-m
C70EU	337440	64 – 70 mm	12 mm Max	109 mm Max	4 N-m
C76EU	337450	70 – 76 mm	12 mm Max	113 mm Max	4 N-m
C82EU	337460	76 – 82 mm	12 mm Max	119 mm Max	4 N-m

Screw is electrogalvanized on clamps that have an outer diameter of 40 mm or less.

Cable/Conduit

CLAMPS AND CLIPS

C-ES CABLE TO VERTICAL FLANGE CLAMP

- Supports multiple runs of cable
- Attaches to beam flanges, angle iron, joists and other structural supports

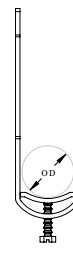
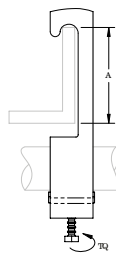

Material: Steel
Finish: Hot-Dip Galvanized

Part Number	Article Number	Outer Diameter	A	Torque
C12ES	337000	6 – 12 mm	43 mm	2 N-m
C16ES	337010	12 – 16 mm	43 mm	2 N-m
C20ES	337020	16 – 20 mm	43 mm	2 N-m
C24ES	337030	20 – 24 mm	43 mm	2 N-m
C28ES	337040	24 – 28 mm	43 mm	2 N-m
C32ES	337050	28 – 32 mm	43 mm	2 N-m
C36ES	337060	32 – 36 mm	43 mm	2 N-m
C40ES	337070	36 – 40 mm	43 mm	2 N-m
C44ES	337080	40 – 44 mm	43 mm	4 N-m
C48ES	337090	44 – 48 mm	43 mm	4 N-m
C52ES	337100	48 – 52 mm	43 mm	4 N-m
C56ES	337110	52 – 56 mm	43 mm	4 N-m
C60ES	337120	56 – 60 mm	43 mm	4 N-m
C64ES	337130	60 – 64 mm	43 mm	4 N-m
C70ES	337140	64 – 70 mm	43 mm	4 N-m
C76ES	337150	70 – 76 mm	43 mm	4 N-m
C82ES	337160	76 – 82 mm	43 mm	4 N-m

Screw is electrogalvanized on clamps that have an outer diameter of 40 mm or less.

Cable/Conduit

CLAMPS AND CLIPS

C-GW CABLE PROTECTION PLATE

- Cable protection plate
- Used with nVent CADDY C-EC, C-EU, C-ERU and C-ES products

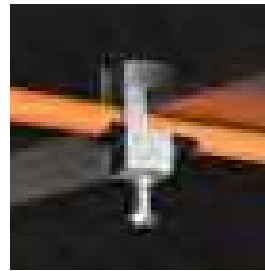

Part Number	Article Number	Outer Diameter	Length
Material: Polyethylene			
C12GW	337800	9 – 12 mm	40 mm
C16GW	337810	13 – 16 mm	40 mm
C20GW	337820	17 – 20 mm	40 mm
C24GW	337830	21 – 24 mm	40 mm
C28GW	337840	25 – 28 mm	40 mm
C32GW	337850	29 – 32 mm	40 mm
C36GW	337860	33 – 36 mm	40 mm
C40GW	337870	37 – 40 mm	40 mm
C48GW	337890	41 – 48 mm	40 mm

C-LW PROTECTION PLATE FOR CABLE CLAMPS

- Cable protection plate
- Used with nVent CADDY C-EC, C-EU, C-ERU and C-ES products

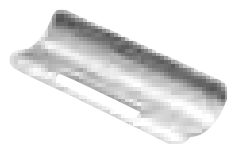

Material: Steel
Finish: Pregalvanized

Part Number	Article Number	Outer Diameter	Length
C12LW	339500	9 – 12 mm	70 mm
C16LW	339510	13 – 16 mm	70 mm

Cable/Conduit

CLAMPS AND CLIPS

PIPE/CABLE CLAMP

- Captive threaded stud minimizes the need for additional hardware
- Attaches to Multi-Function C-Clamp or C-Channel Type E5



Part Number	Article Number	Pipe Size	NB/DN	Outer Diameter	Width	Static Load 1	Static Load 2
Material: Stainless Steel 304 (EN 1.4301)							
CR037S4	336400	3/8"	10	16.0 – 20.0 mm	16 mm	125 N	550 N
CR050S4	336410	1/2"	15	20.0 – 25.0 mm	16 mm	125 N	550 N
CR075S4	336420	3/4"	20	26.9 – 31.8 mm	16 mm	125 N	550 N
CR100S4	336430	1"	25	33.7 – 38.0 mm	20 mm	250 N	550 N
CR125S4	336440	1 1/4"	32	40.0 – 44.5 mm	20 mm	250 N	550 N
CR150S4	336450	1 1/2"	40	47.0 – 51.0 mm	20 mm	250 N	550 N
CR200S4	336460	2"	50	59.2 – 63.5 mm	20 mm	250 N	550 N
Material: Steel, Stainless Steel 304 (EN 1.4301) – Finish: Hot-Dip Galvanized							
CR037HD	336300	3/8"	10	16.0 – 20.0 mm	16 mm	125 N	550 N
CR050HD	336310	1/2"	15	20.0 – 25.0 mm	16 mm	125 N	550 N
CR075HD	336320	3/4"	20	26.9 – 31.8 mm	16 mm	125 N	550 N
CR087HD	336322	7/8"		32.0 – 34.0 mm	16 mm	125 N	550 N
CR100HD	336330	1"	25	33.7 – 38.0 mm	20 mm	250 N	550 N
CR125HD	336340	1 1/4"	32	40.0 – 44.5 mm	20 mm	250 N	550 N
CR150HD	336350	1 1/2"	40	47.0 – 51.0 mm	20 mm	250 N	550 N
CR200HD	336360	2"	50	59.2 – 63.5 mm	20 mm	250 N	550 N

Cable/Conduit

CLAMPS AND CLIPS

MULTI-FUNCTION C-CLAMP

- Multi-functional beam clamp
- Use with Cable/Conduit/Pipe Clamp or Square Washer for Multi-Function C-Clamp

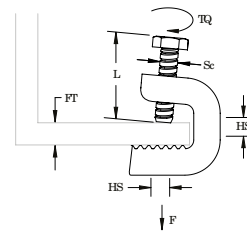

Part Number	Article Number	Flange Thickness	Hole Size	Screw Diameter	Screw Length	Torque	Static Load
Material: Stainless Steel 304 (EN 1.4301)							
C20S4	336130	4 – 20 mm	14 mm	M6	25 mm	3 N-m	1,100 N
C30S4	336140	17 – 30 mm	14 mm	M8	30 mm	3 N-m	1,100 N
C45S4	336150	30 – 44 mm	14 mm	M8	30 mm	3 N-m	1,100 N
Material: Steel – Finish: Hot-Dip Galvanized							
C20HD	336100	4 – 20 mm	14 mm	M6	25 mm	3 N-m	1,100 N
C30HD	336110	17 – 30 mm	14 mm	M8	30 mm	3 N-m	1,100 N
C45HD	336120	30 – 44 mm	14 mm	M8	30 mm	3 N-m	1,100 N

Setscrew must be tightened and torqued onto the sloped side of the I-beam.

FLANGE PROTECTOR FOR MULTI-FUNCTION C-CLAMP

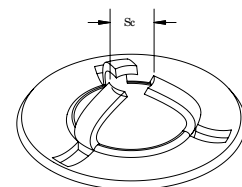

Part Number	Article Number	Screw Diameter
Material: Stainless Steel 304 (EN 1.4301)		
SPPM6S4	336220	M6
SPPM8S4	336230	M8
Material: Steel – Finish: Hot-Dip Galvanized		
SPPM6HD	336200	M6
SPPM8HD	336210	M8

When the laquer protective plates are used, the clamping range is reduced by approximately 3 mm and the permissible load must be reduced by 20%. The screw tip should be placed so it will not damage the paint of the steel structure.

Cable/Conduit

CLAMPS AND CLIPS

SQUARE NUT FOR MULTI-FUNCTION C-CLAMP

- Square adapter nut for Wide Mouth Steel C-Clamp
- Exact fit into C-Clamp; nuts do not twist during installation

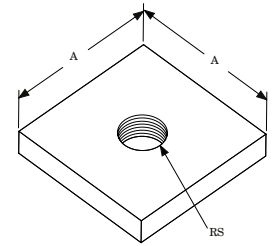

Part Number	Article Number	Rod Size	A
Material: Stainless Steel 304 (EN 1.4301)			
CNM6S4	336180	M6	28 mm
CNM8S4	336190	M8	28 mm
Material: Steel – Finish: Hot-Dip Galvanized			
CNM6	336160	M6	28 mm
CNM8	336170	M8	28 mm

WIRE BASKET TRAY CLIP

- Attaches wire basket tray to strut without additional hardware
- No tools required

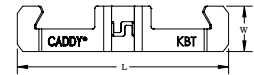

Material: Spring Steel
Finish: nVent CADDY Armour

Part Number	Article Number	Wire Size	Length	Width	Standard Packaging Quantity
KBT	170011	4 – 8 mm	74 mm	16 mm	100 pc

Use two clips per strut support for trays up to 12" (300mm). Use three clips per strut support for trays up to 18" (457mm) and add one clip per strut support for each additional 6" (150mm) of tray width. No load rating, for positioning only.

Cable/Conduit

CABLE TRAY AND ACCESSORIES

CABLE TRAY TO STRUT CLIP

- Fastens wire basket tray to strut

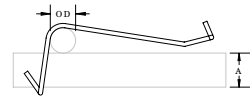

Material: Stainless Steel 301 (EN 1.4310)

Part Number	Article Number	Outer Diameter	A
WCTM	181996	5 mm	8 mm

CABLE TRAY WITH FLANGE CLIP

- Quick and easy solution to support datacom cables along existing I-beams
- Half the weight and is an alternative to traditional cable tray
- Utilizes the lost space within the beam, modifying it to a practical cable tray

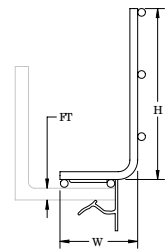
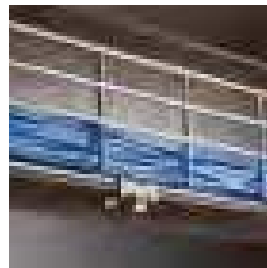
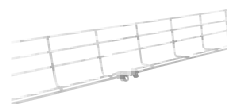

Material: Steel
Finish: Electrogalvanized

Part Number	Article Number	Flange Thickness	Height	Length	Width
BTF24	160820	3 – 8 mm	110 mm	1,500 mm	50 mm
BTF58	160830	8 – 14 mm	110 mm	1,500 mm	50 mm
BTF912	160840	14 – 20 mm	110 mm	1,500 mm	50 mm

CABLE TRAY TO ROD CLIP

- Supports cable tray up to 68 mm wide

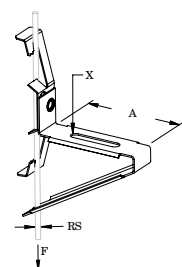

Material: Spring Steel
Finish: nVent CADDY Armour

Part Number	Article Number	Rod Size	A	X	Static Load	Certifications
4Z34CTS	172950	M4, M6, M8	68 mm	35 x 6.5 mm	90 N	ITB
6Z34CTS	172960	M8, M10, M12	68 mm	35 x 6.5 mm	90 N	ITB

Cable/Conduit

CABLE TRAY AND ACCESSORIES

UNIVERSAL TRAY SUPPORT

- Universal design to accommodate various cable tray hanging methods including ceiling, wall, threaded rod, or cable hanging systems
- C-shape maintains accessibility to cables after installation is completed
- Strut profile on both arms allow for two runs of cable trays per bracket
- Top tab can be bent allowing for extra wide cable trays to be installed when two brackets are fastened back-to-back
- Key holes provided for wall mount applications
- Works with the KBT Wire Basket Tray Clip for securing wire basket cable tray or J-bolts for securing cable ladder

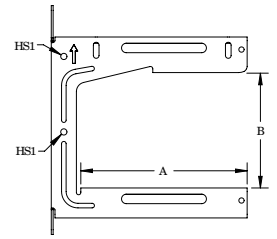
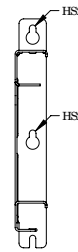
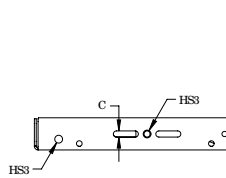

Material: Steel
Finish: Electrogalvanized
Color: White



Part Number	Article Number	A	B	C	Hole Size 1	Hole Size 2	Hole Size 3	Static Load 1	Static Load 2
UTS150	182031	165.1 mm	154.1 mm	8.3 mm	8.4 mm	8.4 mm	10.5 mm	440 N	890 N
UTS200	182032	223.9 mm	154.1 mm	8.3 mm	8.4 mm	9.0 mm	10.5 mm	440 N	890 N
UTS300	182033	323.2 mm	156.6 mm	8.3 mm	8.4 mm	8.4 mm	10.5 mm	440 N	890 N

Refer to Static Load 1 for installations with threaded rod.
Refer to Static Load 2 for wall mount and 3 mm nVent CADDY Speed Link installations.

WIRE BASKET SUPPORT CLIP

- Allows wire basket to be suspended from threaded rod without the need of a strut trapeze
- Securing fingers provides superior stability, preventing damage to the cables in the basket
- Allows for pre-fabrication off site

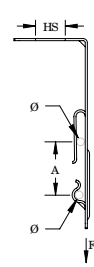

Material: Spring Steel
Finish: nVent CADDY Armour

Part Number	Article Number	Hole Size	A	Diameter	Static Load
WBS2	182019	13.7 mm	24 – 32 mm	3.5 – 6.0 mm	530 N

Cable/Conduit

CABLE TRAY AND ACCESSORIES

WIRE BASKET SUPPORT CLIP, RETROFIT

- Allows wire basket to be suspended from threaded rod without the need of a strut trapeze
- Slotted design allows wire basket to be installed above an existing trapeze
- Securing fingers provides superior stability, preventing damage to the cables in the basket
- Allows for pre-fabrication off site

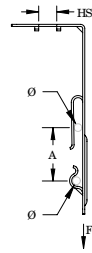

Material: Spring Steel
Finish: nVent CADDY Armour

Part Number	Article Number	Hole Size	A	Diameter	Static Load
WBS1	182015	10.4 mm	24 – 32 mm	3.5 – 6.0 mm	530 N

2. Ceiling/Acoustical



Ceiling/Acoustical

ADJUSTABLE BOX COMPONENTS AND CONDUIT SUPPORTS

T-GRID CLIP, TOP MOUNT

- Clips on acoustical tee bar providing a threaded hole for securing conduit, boxes, or bridle rings
- Eliminates need for offset bending conduit

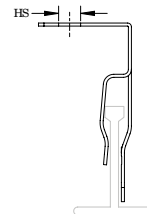

Material: Spring Steel
Finish: nVent CADDY Armour

Part Number	Article Number	Hole Size	Hole Type
ATA4I	170400	M6	Threaded

No load rating, for positioning only.

T-GRID CLIP, SIDE MOUNT

- Clips on acoustical tee bar providing a threaded hole for securing conduit, boxes, or bridle rings
- Eliminates need for offset bending conduit

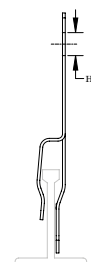

Material: Spring Steel
Finish: nVent CADDY Armour

Part Number	Article Number	Hole Size	Hole Type
ATS4I	170420	M6	Threaded

No load rating, for positioning only. Additional support required per NEC® 300.11.

MATA CONDUIT TO T-GRID CLIP

- Provides a method of securing conduit above acoustical tee bar
- No tools required for installation
- Eliminates need for offset bending conduit

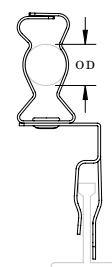
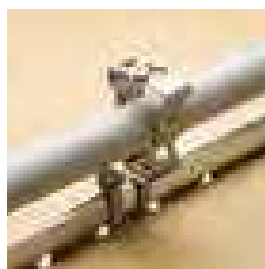

Material: Spring Steel
Finish: nVent CADDY Armour

Part Number	Article Number	Outer Diameter
812MATA	177190	18 – 30 mm

No load rating, for positioning only. Additional support required per NEC® 300.11.

Ceiling/Acoustical

ADJUSTABLE BOX COMPONENTS AND CONDUIT SUPPORTS

MATS CONDUIT TO T-GRID CLIP

- Provides a method of securing conduit above acoustical tee bar
- Clip rotates for securing conduit in either horizontal or vertical orientation
- No tools required for installation
- Eliminates need for offset bending conduit

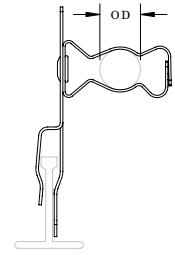

Material: Spring Steel
Finish: nVent CADDY Armour

Part Number	Article Number	Outer Diameter
812MATS	177200	18 – 30 mm

No load rating, for positioning only. Additional support required per NEC@ 300.11.

CHK CHAIN

- Versatile non-welded double loop chain
- Conforms to DIN 5686

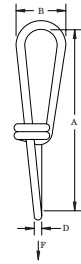
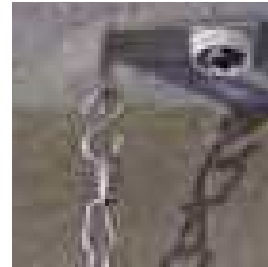

Material: Steel
Finish: Electrogalvanized

Part Number	Article Number	Length	A	B	D	Static Load	Certifications
CHK22K	385860	30 m	28 mm	9.0 mm	2.0 mm	400 N	ITB
CHK25K	385870	30 m	31 mm	10.0 mm	2.2 mm	500 N	ITB
CHK27K	385880	30 m	35 mm	11.0 mm	2.5 mm	700 N	ITB
CHK30K	385890	30 m	39 mm	12.5 mm	2.8 mm	900 N	ITB
CHK32K	385900	25 m	41 mm	14.0 mm	3.1 mm	1,200 N	ITB

CHN CHAIN

- Round link chain
- Conforms to DIN 5685

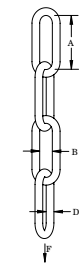
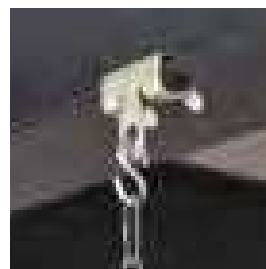

Part Number	Article Number	Length	A	B	D	Static Load	Certifications
Material: Stainless Steel 304 (EN 1.4301)							
CHN15KS4	591500	30 m	24 mm	4.5 mm	2.5 mm	300 N	ITB
CHN17KS4	591510	30 m	26 mm	5.5 mm	3.0 mm	400 N	ITB
Material: Steel – Finish: Electrogalvanized							
CHN13K	386780	30 m	22 mm	3.5 mm	2.0 mm	200 N	ITB
CHN15K	385910	30 m	24 mm	4.5 mm	2.5 mm	300 N	ITB
CHN17K	385920	30 m	26 mm	5.5 mm	3.0 mm	400 N	ITB
CHN13KSP	591410	100 m	22 mm	3.5 mm	2.0 mm	200 N	–

Ceiling/Acoustical

CHAIN AND HOOKS

KN HOOK

- Use to repair a link or combine two chains together by hammering the link shut

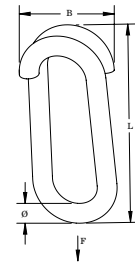
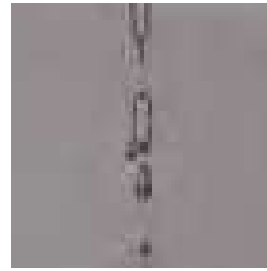

Material: Steel
Finish: Electrogalvanized

Part Number	Article Number	Diameter	Length	B	Static Load
KN30EG	380050	3 mm	16.5 mm	12.5 mm	370 N
KN40EG	380060	4 mm	20.0 mm	16.0 mm	550 N
KN50EG	380070	5 mm	23.0 mm	20.0 mm	950 N

S HOOK

- For suspending chains, perforated bands, and similar items

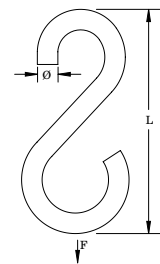
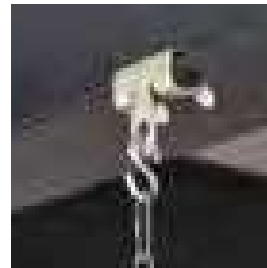

Part Number	Article Number	Diameter	Length	Static Load	Standard Packaging Quantity
Material: Stainless Steel 304 (EN 1.4301)					
S40S4	591650	4 mm	35 mm	250 N	100 pc
S50S4	591660	5 mm	45 mm	400 N	100 pc
Material: Steel – Finish: Electrogalvanized					
S30EG	591570	3 mm	25 mm	120 N	100 pc
S40EG	591580	4 mm	35 mm	250 N	100 pc
S40EGSP25	172420	4 mm	35 mm	250 N	10 x 25 pc
S50EG	591590	5 mm	45 mm	400 N	100 pc

Ceiling/Acoustical

T-GRID TWIST CLIPS

INDEPENDENT SUPPORT CLIP

- Provides a means of independent support of fixtures
- No tools required for installation
- Includes mounting hardware

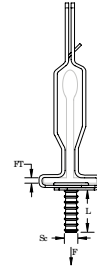
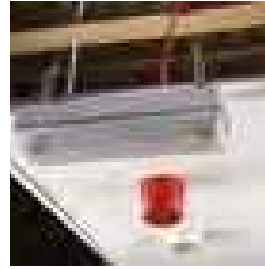

Material: Spring Steel
Finish: nVent CADDY Armour

Part Number	Article Number	T-Grid Size	Flange Thickness	Screw Diameter	Screw Length	Static Load
IDSM16	173460	24 mm	1.5 mm	M6	16 mm	290 N

Not to exceed static load without independent wire support to box mounting clip. Not permitted for paddle fans.

4G16 TWIST CLIP

- Fast, easy and secure twist-on installation
- No special tools required



Material: Spring Steel
Finish: nVent CADDY Armour

Part Number	Article Number	T-Grid Size	Hole Size	Static Load
4G16LS	171670	24 mm	6.1 mm	220 N

Ceiling/Acoustical

T-GRID TWIST CLIPS

4G16 TWIST CLIP WITH STUD

- Supports electrical fixtures from acoustical T-grid
- No tools required for installation
- Fast, easy and secure twist-on installation
- Nut sold separately

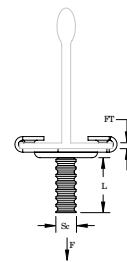
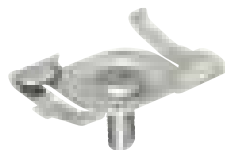

Material: Spring Steel, Steel

Part Number	Article Number	Flange Thickness	T-Grid Size	Screw Diameter	Screw Length	Static Load	Certifications	Standard Packaging Quantity
Finish: nVent CADDY Armour – Color: Gray								
4G16M7	178590	1.5 mm	24 mm	M6	7 mm	220 N	ITB	100 pc
4G16M11	178600	1.5 mm	24 mm	M6	11 mm	220 N	ITB	100 pc
4G16M16	171900	1.5 mm	24 mm	M6	16 mm	220 N	ITB	100 pc
4G16M25	176880	1.5 mm	24 mm	M6	25 mm	220 N	ITB	100 pc
Finish: Painted – Color: White								
4G16M11WH	178620	1.5 mm	24 mm	M6	11 mm	220 N	ITB	100 pc
4G16M16WH	576940	1.5 mm	24 mm	M6	16 mm	220 N	ITB	100 pc

4G16 TWIST CLIP WITH WING NUT

- Supports electrical fixtures from acoustical T-grid
- No tools required for installation
- Fast, easy and secure twist-on installation
- Wing nut included



Material: Steel
Finish: nVent CADDY Armour
Color: Gray

Part Number	Article Number	T-Grid Size	Screw Diameter	Screw Length	Static Load
4G16WN	176710	24 mm	M6	16 mm	220 N

4G16H TWIST CLIP WITH 90° PLAIN HOLE

- Provides an attachment for nVent CADDY Speed Link assemblies, wire, S-hooks, or chain from T-Grid
- Fast, easy and secure twist-on installation
- No tools required for installation

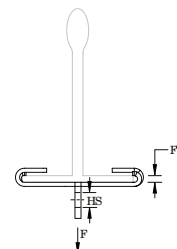
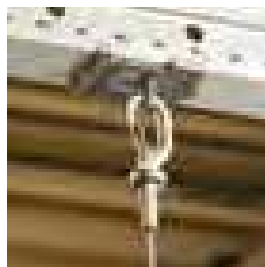

Material: Spring Steel



Part Number	Article Number	Hole Size	Flange Thickness	T-Grid Size	Static Load	Certifications
Finish: nVent CADDY Armour – Color: Gray						
4G16H	170230	6.4 mm	1.5 mm Max	24 mm	180 N	ITB, UL
Finish: Painted – Color: White						
4G16HWH	576950	6.4 mm	1.5 mm Max	24 mm	180 N	ITB, UL

Ceiling/Acoustical

T-GRID TWIST CLIPS

4G24 TWIST CLIP WITH STUD

- Supports electrical fixtures from acoustical T-grid
- No tools required for installation
- Fast, easy and secure twist-on installation
- Designed to reduce scratching of T-grid
- Nut sold separately

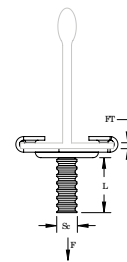

Material: Spring Steel, Steel

Part Number	Article Number	Screw Length	Flange Thickness	T-Grid Size	Screw Diameter	Static Load	Certifications	Standard Packaging Quantity
Finish: nVent CADDY Armour – Color: Gray								
4G24M11	171680	11 mm	1.5 mm	24 mm	M6	220 N	ITB	100 pc
4G24M16	171710	16 mm	1.5 mm	24 mm	M6	220 N	ITB	100 pc
4G24M25	171730	25 mm	1.5 mm	24 mm	M6	220 N	ITB	100 pc
Finish: Painted – Color: White								
4G24M11WH	171840	11 mm	1.5 mm	24 mm	M6	220 N	ITB	100 pc
4G24M16WH	171860	16 mm	1.5 mm	24 mm	M6	220 N	ITB	100 pc
4G24M16WHSP25	172290	16 mm	1.5 mm	24 mm	M6	220 N	ITB	10 x 25 pc
4G24M25WHSP25	172300	25 mm	1.5 mm	24 mm	M6	220 N	ITB	10 x 25 pc

4G24 TWIST CLIP WITH WING NUT

- Supports electrical fixtures from acoustical T-grid
- No tools required for installation
- Fast, easy and secure twist-on installation
- Designed to reduce scratching of T-grid
- Wing nut included



Material: Spring Steel, Steel
 Finish: nVent CADDY Armour
 Color: Gray

Part Number	Article Number	T-Grid Size	Screw Diameter	Screw Length	Static Load
4G24WN	160290	24 mm	M6	16 mm	220 N

Ceiling/Acoustical

T-GRID TWIST CLIPS

4G24H TWIST CLIP WITH 90° PLAIN HOLE

- Provides an attachment for nVent CADDY Speed Link assemblies, wire, S-hooks, or chain from T-Grid
- Fast, easy and secure twist-on installation
- Designed to reduce scratching of T-grid
- No tools required for installation

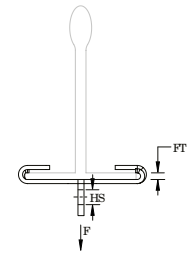
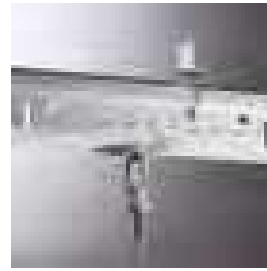

Material: Spring Steel

Part Number	Article Number	Hole Size	Flange Thickness	T-Grid Size	Static Load	Certifications
Finish: nVent CADDY Armour – Color: Gray						
4G24H	170490	5.8 mm	1.5 mm Max	24 mm	180 N	ITB
Finish: Painted – Color: White						
4G24HWH	170500	5.8 mm	1.5 mm Max	24 mm	180 N	ITB
4G24HWHSP25	172280	5.8 mm	1.5 mm Max	24 mm	180 N	ITB

4J15 TWIST CLIP WITH STUD, NARROW GRID

- Fast, easy and secure twist-on installation
- No special tools required
- Designed to reduce scratching of T-grid



Material: Steel, Spring Steel
Finish: nVent CADDY Armour

Part Number	Article Number	T-Grid Size	Screw Diameter	Screw Length	Static Load
4J15M	178860	15 mm	M6	16 mm	220 N

WING NUT FOR TWIST CLIPS

- Large diameter allows the use of knock-outs as mounting points
- Combination wing nut and washer

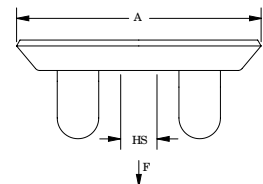

Material: Spring Steel
Finish: nVent CADDY Armour

Part Number	Article Number	Hole Size	Hole Type	A	Static Load	Certifications	Standard Packaging Quantity
6WN	171560	M6	Threaded	33.7 mm	450 N	ITB	100 pc

When using with other fasteners refer to the lowest load rating.

3. Stud Wall



Stud Wall

STUD MOUNTED BOX BRACKETS

MSF SNAP-ON BOX SUPPORT

- Spring steel for press-on attachment
- Center hole assists in consistent alignment, exact positioning and screw attachment
- Requires hammer to attach clip to box

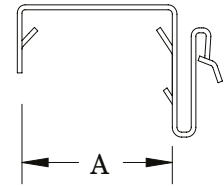

Material: Spring Steel
Finish: nVent CADDY Armour



Part Number	Article Number	A	Hole Size
MSF	179965	35 – 38 mm	7.1 mm

ADJUSTABLE DEPTH SNAP-ON SWITCH BOX SUPPORT

- Allows the switch box to protrude through any size drywall
- Fits most drywall studding

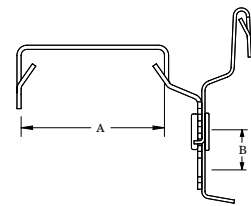
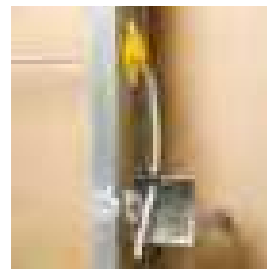

Material: Spring Steel
Finish: nVent CADDY Armour

Part Number	Article Number	A	B
MFSE	160991	35 – 38 mm	6.4 – 19.1 mm

Stud Wall

CABLE/CONDUIT TO STUD

"COLORADO JIM" CABLE SUPPORT

- Easy-to-use locking tab
- Cable locating ribs to maintain cable separation
- Flared edges for cable protection
- NEC® 300.4D applicable
- For wood or metal stud

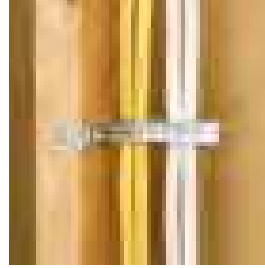

Material: Steel
Finish: Pregalvanized



Part Number	Article Number	Standard Packaging Quantity
CJ6	176830	100 pc

"COLORADO JIM" CABLE SUPPORT WITH STANDOFF

- Easy-to-use locking tab
- Cable locating ribs to maintain cable separation
- Flared edges for cable protection
- NEC® 300.4D applicable
- AC or Flexible Cable to Furring strip and hat channel

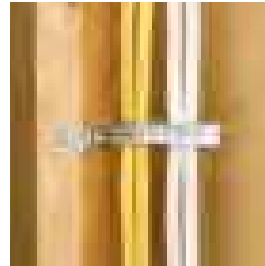

Material: Steel
Finish: Pregalvanized



Part Number	Article Number	Standard Packaging Quantity
CJ6S	160880	100 pc

CS812 CABLE/CONDUIT TO STUD ATTACHMENT

- Accommodates EMT conduit and MC/AC cable
- Easily locate the fastener on the stud, keeping your conduit in line with box knock out and H-series brackets
- For wood or metal stud
- Eliminates offset bending of conduit
- Compliant with NEC® Article 358.30(A), which requires conduit support within 36" of an electrical box
- Compliant with CEC Rule 12-1404, which requires conduit support within 1 m of an electrical box
- Compliant with CEC Rule 12-618, which requires support of armoured cable within 300 mm (12") of an electrical box

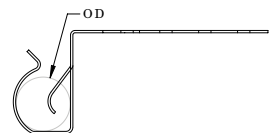
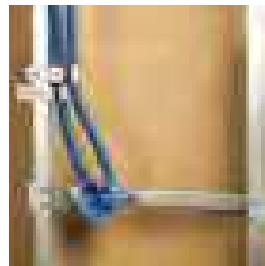

Material: Spring Steel
Finish: nVent CADDY Armour



Part Number	Article Number	Outer Diameter OD	Box Depth	Standard Packaging Quantity
CS812	176910	18 – 30 mm	38 mm	100 pc

Stud Wall

SCREW GUN BRACKETS AND ACCESSORIES

TELESCOPING SCREW GUN BOX BRACKET

- Can mount multiple boxes
- Notched and marked for easy identification and bending
- Improved design with stamped inch markings and pilot holes accelerates precise box conduit mounting between studs
- Pilot holes allow easy box attachment with a screwdriver
- Requires only a screw gun to install
- Can be mounted to face or inside of stud
- Adjustable for non-standard stud spacing
- Interlocking tab prevents accidental disassembly
- Unique, one-piece, break apart design

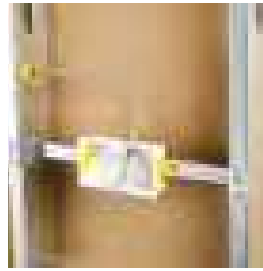
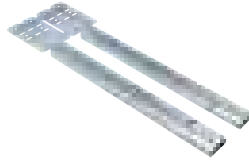

Material: Steel
Finish: Pregalvanized



Part Number	Article Number	Stud Spacing	Box Depth	Standard Packaging Quantity
TSGB16	187190	280 – 458 mm	38.0 mm, 54.0 mm	50 pc
TSGB1624	187199	400 – 635 mm	38.0 mm, 54.0 mm, 63.5 mm	50 pc
TSGB24	187191	432 – 660 mm	38.0 mm, 54.0 mm, 63.5 mm	50 pc

BARRNOG/TSGBHD ADJUSTABLE METAL NOGGING

- Flat sliding plate for use with heavier applications
- Use self drilling/tapping screws for mounting onto bracket

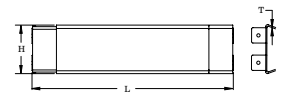
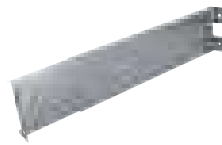

Material: Steel
Finish: Electrogalvanized

Part Number	Article Number	Length	Height	Thickness
BARRNOG	187189	330 – 600 mm	92 mm	1 mm

Stud Wall

THROUGH STUD CABLE/CONDUIT SUPPORTS

SMS8 SELF-DRILLING AND TAPPING SCREW

- Suitable for screw gun use
- Thin “wafer-head” type

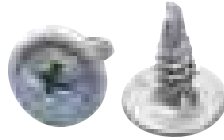

Material: Steel
Finish: Electrogalvanized

Part Number	Article Number	Screw Diameter	Screw Length
SMS8	187197	4.2 mm	12 mm

EASY SNAP GROMMET

- Provides 360° protection for cable, conduit, plumbing and fire sprinkler plumbing in metal studs
- Snap one grommet into standard 1-11/32” field punched hole, or snap two together into any shape factory-punched hole
- Grommet can be split for use on pre-existing installations

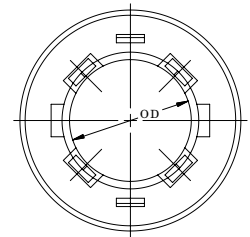
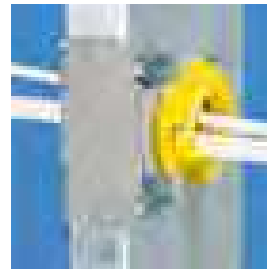

Material: Polyethylene

Part Number	Article Number	Outer Diameter	Standard Packaging Quantity
ESG1	188470	33 mm	100 pc

MSP20 METAL STUD PUNCH FOR EASY SNAP GROMMET

- Punches standard sized holes in metal studs
- Easy Snap Grommet snaps easily into punched hole
- Cushioned handles mean less operator fatigue and more comfortable handling
- Tool design with offset handles allows punch to work in confined locations and near perpendicular walls
- Lightweight punch makes accurate location of holes easier
- Hardened steel components keep tool sharp longer – less replacement



Material: Steel

Part Number	Article Number	Hole Size
MSP20	188480	34.1 mm

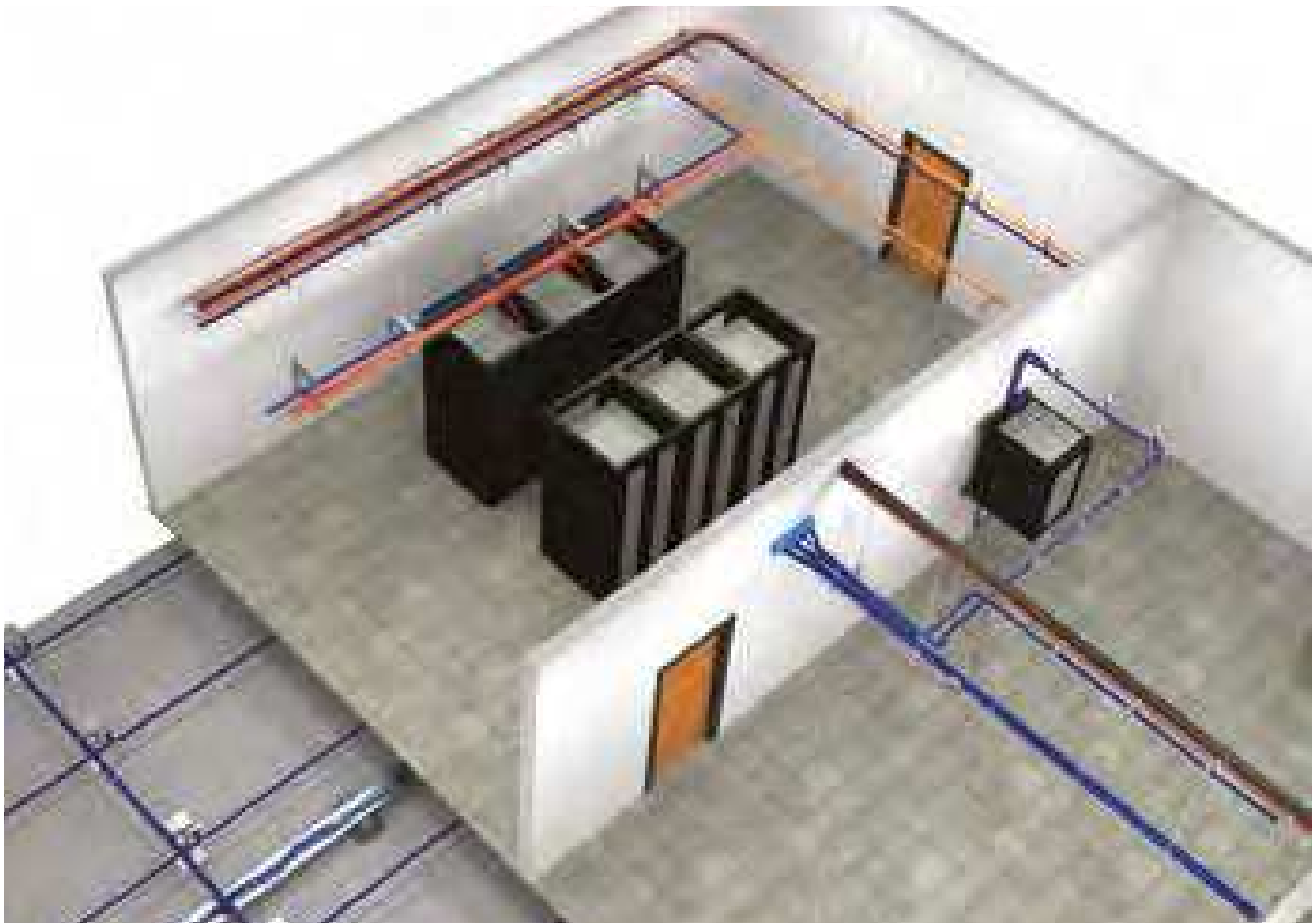

CONNECT AND PROTECT

The nVent CADDY Guide to Datacom Solutions Brochure H84406

Project engineers and contractors responsible for datacom system installations have simple priorities: get the job done right, safely, and quickly. Now you can depend on nVent CADDY for innovative products to help you meet these goals. These solutions for datacom applications help to lower overall installation cost with cable runways that complement or replace labor-intensive methods such as cable tray or strut trapeze. nVent CADDY's innovative fixing, fastening and support products provide the perfect solution for thousands of datacom applications. The result: Contractors can focus more on meeting project deadlines and less on procuring the right components.

nVent CADDY offers a complete system to allow contractors to shop for all datacom fastening needs in one stop - from mounting enclosures, hanging cable trays, supporting branch lines, all the way to supporting cables on a rooftop.

nVent.com/CADDY

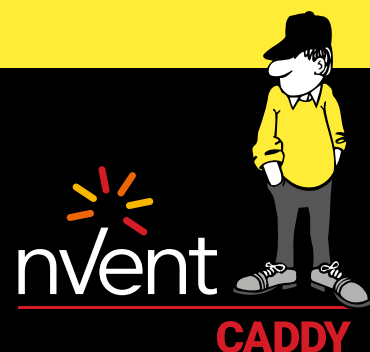

CADDY ERICO HOFFMAN RAYCHEM SCHROFF TRACER

CADDY

4. Datacom/Low Voltage



Datacom/Low Voltage

CABLE SUPPORT SYSTEMS

NVENT CADDY CAT HP J-HOOK

- Provides optimal support for high-performance data cable, up to and including Cat 5e, Cat 6, Cat 6A, Cat 7 and fibre optic
- Rounded edges on J-Hooks provide proper bend radius support for high performance data cables
- Multiple color options aid in the identification and organization of the pathway application
- Provides superior fill capacity and load rating over most other non-continuous cable support alternatives
- Compliant with UL® 2043 and suitable for use in air handling (plenum) spaces
- Tested according to DIN 4102-12
- Complies with EN 50174-2
- Meets ISO®/IEC 14763-2, ANSI®/TIA 568 and ANSI®/TIA 569
- Painted J-Hooks are low-smoke and halogen-free

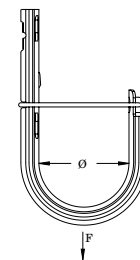
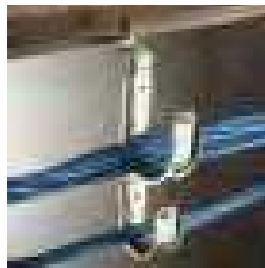

Material: Steel



Part Number	Article Number	Diameter	Area	Cable Capacity, Cat 5e	Cable Capacity, Cat 6	Cable Capacity, Cat 6A	Static Load	Certifications
Finish: Pregalvanized								
CAT16HP	181061	25.0 mm	690 mm ²	20	15	10	270 N	cULus, E30, E60, E90, ITB
CAT21HP	181188	33.3 mm	1,174 mm ²	50	40	25	270 N	cULus
CAT32HP	181062	50.0 mm	2,561 mm ²	90	60	35	270 N	cULus, E30, E60, E90, ITB
CAT48HP	181063	75.0 mm	5,974 mm ²	200	150	80	270 N	cULus, E30, E60, E90, ITB
CAT64HP	181064	100.0 mm	9,987 mm ²	330	220	140	270 N	cULus, E30, E60, E90, ITB

Non-continuous supports may not exceed spacing of 5' (1.5 m) per TIA 569-C.9.7 and EN 50174-2. Cable capacity is calculated based on a 70% fill rate.

Setscrew must be tightened and torqued onto the sloped side of the I-beam. Non-continuous supports may not exceed spacing of 5' (1.5 m) per TIA 569-C.9.7 and EN 50174-2. Cable capacity is calculated based on a 70% fill rate.

Cable	Number of Twisted Pairs	AWG	Cable Diameter	Capacity (70% fill)			
				CAT16HP	CAT32HP	CAT48HP	CAT64HP
UTP	4	24	5 mm	20	70	160	280
FTP	4	24	6 mm	15	50	110	190
SFTP	4	24	6 mm	15	50	110	190
SFTP	4	23	7 mm	10	40	85	140
F/STP	4	23	8,5 mm	7	25	60	100
SFTP	4	23	8,5 mm	7	25	60	100
SFTP	3x4	24	14 mm	2	9	20	35
UTP	25	24	13 mm	3	11	25	40

Datacom/Low Voltage

CABLE SUPPORT SYSTEMS

nVENT CADDY CAT HP J-HOOK WITH BC BEAM CLAMP

- Easy installation to beam flanges
- Provides optimal support for high-performance data cable, up to and including Cat 5e, Cat 6, Cat 6A, Cat 7 and fibre optic
- Provides superior fill capacity and load rating over most other non-continuous cable support alternatives
- Rounded edges on J-Hooks provide proper bend radius support for high performance data cables
- Cost effective alternative to expensive cable tray
- Complies with EN 50174-2
- Meets ISO®/IEC 14763-2, ANSI®/TIA 568 and ANSI®/TIA 569

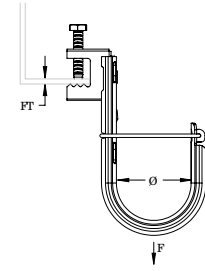

Material: Steel, Spring Steel
Finish: Pregalvanized, nVent CADDY Armour



Part Number	Article Number	Diameter	Area	Cable Capacity, Cat 5e	Cable Capacity, Cat 6	Cable Capacity, Cat 6A	Flange Thickness	Static Load
CAT16HPBC	181201	25.0 mm	690 mm ²	20	15	10	16 mm Max	270 N
CAT21HPBC	181238	33.3 mm	1,174 mm ²	50	40	25	16 mm Max	270 N
CAT32HPBC	181202	50.0 mm	2,561 mm ²	90	60	35	16 mm Max	270 N
CAT48HPBC	181203	75.0 mm	5,974 mm ²	220	140	80	16 mm Max	270 N

Non-continuous supports may not exceed spacing of 5' (1.5 m) per TIA 569-C.9.7 and EN 50174-2. Cable capacity is calculated based on a 70% fill rate.

Datacom/Low Voltage

CABLE SUPPORT SYSTEMS

NVENT CADDY CAT HP J-HOOK WITH BC BEAM CLAMP, SWIVEL

- Easy installation to beam flanges
- Rotates 360° to support various directional runs of cable
- Provides optimal support for high-performance data cable, up to and including Cat 5e, Cat 6, Cat 6A, Cat 7 and fibre optic
- Provides superior fill capacity and load rating over most other non-continuous cable support alternatives
- Rounded edges on J-Hooks provide proper bend radius support for high performance data cables
- Cost effective alternative to expensive cable tray
- Complies with EN 50174-2
- Meets ISO®/IEC 14763-2, ANSI®/TIA 568 and ANSI®/TIA 569

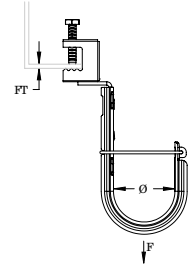

Material: Steel, Spring Steel
Finish: Pregalvanized, nVent CADDY Armour



Part Number	Article Number	Diameter	Area	Cable Capacity, Cat 5e	Cable Capacity, Cat 6	Cable Capacity, Cat 6A	Flange Thickness	Static Load	Certifications
CAT16HPBCB	181219	25.0 mm	690 mm ²	20	15	10	16 mm Max	270 N	cULus, E30, E60, E90
CAT21HPBCB	181245	33.3 mm	1,174 mm ²	50	40	25	16 mm Max	270 N	cULus
CAT32HPBCB	181221	50.0 mm	2,561 mm ²	90	60	35	16 mm Max	270 N	cULus, E30, E60, E90
CAT48HPBCB	181222	75.0 mm	5,974 mm ²	200	150	80	16 mm Max	270 N	cULus, E30, E60, E90
CAT64HPBCB	181021	100.0 mm	9,987 mm ²	330	220	140	16 mm Max	270 N	cULus, E30, E60, E90

Non-continuous supports may not exceed spacing of 5' (1.5 m) per TIA 569-C.9.7 and EN 50174-2.
Cable capacity is calculated based on a 70% fill rate.

Datacom/Low Voltage

CABLE SUPPORT SYSTEMS

nVENT CADDY CAT HP J-HOOK WITH HAMMER-ON FLANGE CLIP

- Requires only a hammer to install
- Provides optimal support for high-performance data cable, up to and including Cat 5e, Cat 6, Cat 6A, Cat 7 and fibre optic
- Provides superior fill capacity and load rating over most other non-continuous cable support alternatives
- Rounded edges on J-Hooks provide proper bend radius support for high performance data cables
- Cost effective alternative to expensive cable tray
- Complies with EN 50174-2
- Meets ISO®/IEC 14763-2, ANSI®/TIA 568 and ANSI®/TIA 569

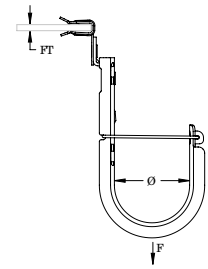

Material: Steel, Spring Steel
Finish: Pregalvanized, nVent CADDY Armour



Part Number	Article Number	Diameter	Area	Cable Capacity, Cat 5e	Cable Capacity, Cat 6	Cable Capacity, Cat 6A	Flange Thickness	Static Load	Certifications
CAT16HP24SM	181098	25.0 mm	690 mm ²	20	15	10	3 – 8 mm	270 N	cULus, E30, E60, E90
CAT16HP58SM	181151	25.0 mm	690 mm ²	20	15	10	8 – 14 mm	270 N	cULus, E30, E60, E90
CAT21HP24SM	181197	33.3 mm	1,174 mm ²	50	40	25	3 – 8 mm	270 N	cULus
CAT21HP58SM	181198	33.3 mm	1,174 mm ²	50	40	25	8 – 14 mm	270 N	cULus
CAT32HP24SM	181099	50.0 mm	2,561 mm ²	90	60	35	3 – 8 mm	270 N	cULus, E30, E60, E90
CAT48HP58SM	181157	75.0 mm	5,974 mm ²	200	150	80	8 – 14 mm	270 N	cULus, E30, E60, E90
CAT64HP58SM	181161	100.0 mm	9,987 mm ²	330	220	140	8 – 14 mm	270 N	cULus, E30, E60, E90

Non-continuous supports may not exceed spacing of 5' (1.5 m) per TIA 569-C.9.7 and EN 50174-2. Cable capacity is calculated based on a 70% fill rate.

Datacom/Low Voltage

CABLE SUPPORT SYSTEMS

NVENT CADDY CAT HP J-HOOK WITH HAMMER-ON FLANGE CLIP, SWIVEL

- Requires only a hammer to install
- Rotates 360° to support various directional runs of cable
- Provides optimal support for high-performance data cable, up to and including Cat 5e, Cat 6, Cat 6A, Cat 7 and fibre optic
- Provides superior fill capacity and load rating over most other non-continuous cable support alternatives
- Rounded edges on J-Hooks provide proper bend radius support for high performance data cables
- Cost effective alternative to expensive cable tray
- Complies with EN 50174-2
- Meets ISO®/IEC 14763-2, ANSI®/TIA 568 and ANSI®/TIA 569

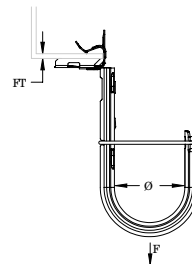

Material: Steel, Spring Steel
Finish: Pregalvanized, nVent CADDY Armour



Part Number	Article Number	Diameter	Area	Cable Capacity, Cat 5e	Cable Capacity, Cat 6	Cable Capacity, Cat 6A	Flange Thickness	Static Load	Certifications
CAT16HP24	181213	25.0 mm	690 mm ²	20	15	10	3 – 8 mm	270 N	cULus, E30, E60, E90
CAT16HP58	181001	25.0 mm	690 mm ²	20	15	10	8 – 14 mm	270 N	cULus, E30, E60, E90
CAT32HP24	181214	50.0 mm	2,561 mm ²	90	60	35	3 – 8 mm	270 N	cULus, E30, E60, E90
CAT32HP58	181002	50.0 mm	2,561 mm ²	90	60	35	8 – 14 mm	270 N	cULus, E30, E60, E90
CAT48HP24	181215	75.0 mm	5,974 mm ²	200	150	80	3 – 8 mm	270 N	cULus, E30, E60, E90
CAT48HP58	181231	75.0 mm	5,974 mm ²	200	150	80	8 – 14 mm	270 N	cULus, E30, E60, E90
CAT48HP912	181232	75.0 mm	5,974 mm ²	200	150	80	14 – 20 mm	270 N	cULus, E30, E60, E90
CAT64HP24	181216	100.0 mm	9,987 mm ²	330	220	140	3 – 8 mm	270 N	cULus, E30, E60, E90
CAT64HP58	181003	100.0 mm	9,987 mm ²	330	220	140	8 – 14 mm	270 N	cULus, E30, E60, E90
CAT64HP912	181006	100.0 mm	9,987 mm ²	330	220	140	14 – 20 mm	270 N	cULus, E30, E60, E90

Non-continuous supports may not exceed spacing of 5' (1.5 m) per TIA 569-C.9.7 and EN 50174-2. Cable capacity is calculated based on a 70% fill rate.

Datacom/Low Voltage

CABLE SUPPORT SYSTEMS

nVENT CADDY CAT HP J-HOOK WITH MULTI-FUNCTION CLIP

- Quick attachment to threaded rod or wire
- Fully adjustable and easy to relocate to accommodate changes once installed
- Provides optimal support for high-performance data cable, up to and including Cat 5e, Cat 6, Cat 6A, Cat 7 and fibre optic
- Provides superior fill capacity and load rating over most other non-continuous cable support alternatives
- Rounded edges on J-Hooks provide proper bend radius support for high performance data cables
- Cost effective alternative to expensive cable tray
- Complies with EN 50174-2
- Meets ISO®/IEC 14763-2, ANSI®/TIA 568 and ANSI®/TIA 569

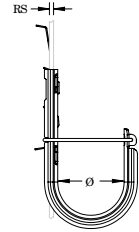

Material: Steel, Spring Steel
 Finish: Pregalvanized, nVent CADDY Armour



Part Number	Article Number	Diameter	Area	Cable Capacity, Cat 5e	Cable Capacity, Cat 6	Cable Capacity, Cat 6A	Rod Size	Wire Size	Static Load
CAT16HP4Z34	181217	25.0 mm	690 mm ²	20	15	10	M4, M6, M8	4.8 – 6.4 mm	130 N
CAT21HP4Z34	181258	33.3 mm	1,174 mm ²	50	40	25	M4, M6, M8	4.8 – 6.4 mm	130 N
CAT32HP4Z34	181218	50.0 mm	2,561 mm ²	90	60	35	M4, M6, M8	4.8 – 6.4 mm	130 N
CAT32HP6Z34	181008	50.0 mm	2,561 mm ²	90	60	35	M8, M10, M12		130 N

Non-continuous supports may not exceed spacing of 5' (1.5 m) per TIA 569-C.9.7 and EN 50174-2. Cable capacity is calculated based on a 70% fill rate.

Datacom/Low Voltage

CABLE SUPPORT SYSTEMS

NVENT CADDY CAT HP J-HOOK WITH NAIL GUN BRACKET

- Provides optimal support for high-performance data cable, up to and including Cat 5e, Cat 6, Cat 6A, Cat 7 and fibre optic
- Complete with concrete nail gun insert bracket
- Clips onto nozzle of gas or battery-actuated nail guns allowing for hands-off installation at structure or from the floor using a pole
- Longer leg angle bracket for tool clearance
- Quickly and easily attaches to concrete, steel or composite metal decking
- Rounded edges on J-Hooks provide proper bend radius support for high performance data cables
- Provides superior fill capacity and load rating over most other non-continuous cable support alternatives
- Complies with EN 50174-2
- Meets ISO®/IEC 14763-2, ANSI®/TIA 568 and ANSI®/TIA 569

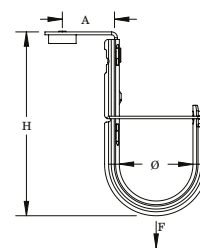

Material: Steel; Nylon
Finish: Electrogalvanized; Pregalvanized

Part Number	Article Number	Diameter	Area	Cable Capacity, Cat 5e	Cable Capacity, Cat 6	Cable Capacity, Cat 6A	Height H	A	Static Load
CAT16HPGBSF	180811	25.0 mm	690 mm ²	20	15	10	110 mm	35.6 mm	270 N
CAT32HPGBSF	180821	50.0 mm	2,561 mm ²	90	60	35	127 mm	35.6 mm	270 N

Static Load represents the static load of the nail gun insert assembly. Please consult with the nail manufacturer to evaluate the static load of the nail and type of concrete used for the installation. Maximum load is the lesser of the static load from the nail manufacturer or the published load for the assembly.

Nail gun insert is compatible with BeA® CN60-688ES, Hilti® BX 3, GX 3, Powers® Trak-It C3, SPIT® PULSA 800E, 700, 1000 or equivalent nailers.

Datacom/Low Voltage

CABLE SUPPORT SYSTEMS

NVENT CADDY CAT HP J-HOOK WITH ANGLE BRACKET

- Ideal for attaching to concrete, steel or wood surfaces
- Provides optimal support for high-performance data cable, up to and including Cat 5e, Cat 6, Cat 6A, Cat 7 and fibre optic
- Provides superior fill capacity and load rating over most other non-continuous cable support alternatives
- Rounded edges on J-Hooks provide proper bend radius support for high performance data cables
- Cost effective alternative to expensive cable tray
- Complies with EN 50174-2
- Meets ISO®/IEC 14763-2, ANSI®/TIA 568 and ANSI®/TIA 569

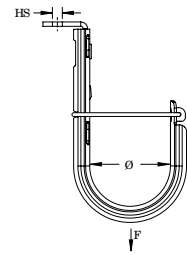

Material: Steel
Finish: Pregalvanized



Part Number	Article Number	Diameter	Area	Cable Capacity, Cat 5e	Cable Capacity, Cat 6	Cable Capacity, Cat 6A	Hole Size	Static Load	Certifications
CAT16HPAB	181209	25.0 mm	690 mm ²	20	15	10	6.3 mm	270 N	cULus, E30, E60, E90
CAT21HPAB	181189	33.3 mm	1,174 mm ²	50	40	25	6.3 mm	270 N	cULus
CAT32HPAB	181211	50.0 mm	2,561 mm ²	90	60	35	6.3 mm	270 N	cULus, E30, E60, E90
CAT48HPAB	181212	75.0 mm	5,974 mm ²	200	150	80	6.3 mm	270 N	cULus, E30, E60, E90
CAT64HPAB	181024	100.0 mm	9,987 mm ²	330	220	140	6.3 mm	270 N	cULus, E30, E60, E90

Non-continuous supports may not exceed spacing of 5' (1.5 m) per TIA 569-C.9.7 and EN 50174-2. Cable capacity is calculated based on a 70% fill rate.

Datacom/Low Voltage

CABLE SUPPORT SYSTEMS

NVENT CADDY CAT HP J-HOOK WITH T-GRID CLIP

- No installation tools required for basic clip
- Provides optimal support for high-performance data cable, up to and including Cat 5e, Cat 6, Cat 6A, Cat 7 and fibre optic
- Provides superior fill capacity and load rating over most other non-continuous cable support alternatives
- Rounded edges on J-Hooks provide proper bend radius support for high performance data cables
- Cost effective alternative to expensive cable tray
- Complies with EN 50174-2
- Meets ISO®/IEC 14763-2, ANSI®/TIA 568 and ANSI®/TIA 569

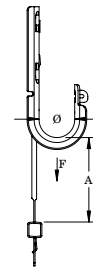

Material: Steel, Spring Steel
Finish: nVent CADDY Armour, Pregalvanized



Part Number	Article Number	Diameter	Area	Cable Capacity, Cat 5e	Cable Capacity, Cat 6	Cable Capacity, Cat 6A	A	Static Load
CAT16HPTS	181089	25 mm	690 mm ²	20	15	10	65 mm	270 N

Additional support wire required per NEC® 300.11.
Non-continuous supports may not exceed spacing of 5' (1.5 m) per TIA 569-C.9.7 and EN 50174-2.
Cable capacity is calculated based on a 70% fill rate.

NVENT CADDY CAT HP J-HOOK CLIP TO BC200 BEAM CLAMP

- Easy installation to beam flanges
- Requires no screws, rivets or special tools for assembly
- J-Hooks feature bendable locking tabs that lock on to nVent CADDY Cat HP components to provide rigidity and stability
- Link to J-Hooks in one of multiple color options to aid in pathway identification and organization
- Customized J-Hook trees can be easily assembled with various J-Hook sizes, colors and configurations
- nVent CADDY Cat HP components easily attach to any size nVent CADDY Cat HP J-Hook

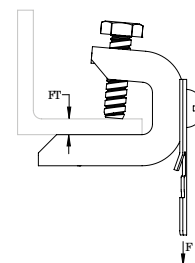

Material: Steel, Spring Steel
Finish: Electrogalvanized, nVent CADDY Armour



Part Number	Article Number	Flange Thickness	Static Load
CATHPBC200	181079	3.2 – 16.0 mm	440 N

Datacom/Low Voltage

CABLE SUPPORT SYSTEMS

NVENT CADDY CAT HP J-HOOK CLIP TO BC BEAM CLAMP

- Easy installation to beam flanges
- Requires no screws, rivets or special tools for assembly
- J-Hooks feature bendable locking tabs that lock on to nVent CADDY Cat HP components to provide rigidity and stability
- Link to J-Hooks in one of multiple color options to aid in pathway identification and organization
- Customized J-Hook trees can be easily assembled with various J-Hook sizes, colors and configurations
- nVent CADDY Cat HP components easily attach to any size nVent CADDY Cat HP J-Hook

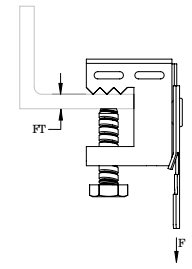

Material: Steel, Spring Steel
Finish: Electrogalvanized, nVent CADDY Armour



Part Number	Article Number	Flange Thickness	Static Load	Certifications
CATHPBC	181078	3.2 – 16.0 mm	440 N	cULus, ITB

NVENT CADDY CAT HP J-HOOK CLIP TO BC BEAM CLAMP, SWIVEL

- Easy installation to beam flanges
- Rotates 360° to support various directional runs of cable
- Requires no screws, rivets or special tools for assembly
- J-Hooks feature bendable locking tabs that lock on to nVent CADDY Cat HP components to provide rigidity and stability
- Link to J-Hooks in one of multiple color options to aid in pathway identification and organization
- Customized J-Hook trees can be easily assembled with various J-Hook sizes, colors and configurations
- nVent CADDY Cat HP components easily attach to any size nVent CADDY Cat HP J-Hook

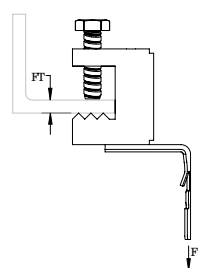

Material: Steel, Spring Steel
Finish: Electrogalvanized, nVent CADDY Armour



Part Number	Article Number	Flange Thickness	Static Load	Certifications
CATHPBCB	181073	3.2 – 16.0 mm	267 N	cULus, E30, E60, E90, ITB

Datacom/Low Voltage

CABLE SUPPORT SYSTEMS

NVENT CADDY CAT HP J-HOOK CLIP TO HAMMER-ON FLANGE CLIP, SWIVEL

- Requires only a hammer to install
- Rotates 360° to support various directional runs of cable
- Requires no screws, rivets or special tools for assembly
- J-Hooks feature bendable locking tabs that lock on to nVent CADDY Cat HP components to provide rigidity and stability
- Link to J-Hooks in one of multiple color options to aid in pathway identification and organization
- Customized J-Hook trees can be easily assembled with various J-Hook sizes, colors and configurations
- nVent CADDY Cat HP components easily attach to any size nVent CADDY Cat HP J-Hook

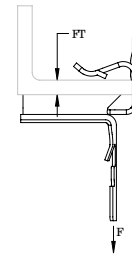

Material: Spring Steel
Finish: nVent CADDY Armour



Part Number	Article Number	Flange Thickness	Static Load	Certifications
CATHP24	181091	3 – 8 mm	334 N	cULus, E30, E60, E90, ITB
CATHP58	181071	8 – 14 mm	334 N	cULus, E30, E60, E90, ITB
CATHP912	181072	14 – 20 mm	334 N	cULus, E30, E60, E90, ITB

NVENT CADDY CAT HP J-HOOK CLIP TO C PURLIN CLIP

- Hammer-on or install from the floor with the VAFT tool
- Requires no screws, rivets or special tools for assembly
- J-Hooks feature bendable locking tabs that lock on to nVent CADDY Cat HP components to provide rigidity and stability
- Link to J-Hooks in one of multiple color options to aid in pathway identification and organization
- Customized J-Hook trees can be easily assembled with various J-Hook sizes, colors and configurations
- nVent CADDY Cat HP components easily attach to any size nVent CADDY Cat HP J-Hook

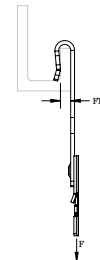

Material: Spring Steel
Finish: nVent CADDY Armour



Part Number	Article Number	Flange Thickness	Static Load	Certifications
CATHPVF14	181081	1.5 – 6.0 mm	712 N	cULus, ITB

Datacom/Low Voltage

CABLE SUPPORT SYSTEMS

NVENT CADDY CAT HP J-HOOK CLIP TO ROD/WIRE CLIP

- Quick attachment to threaded rod or wire
- Requires no screws, rivets or special tools for assembly
- J-Hooks feature bendable locking tabs that lock on to nVent CADDY Cat HP components to provide rigidity and stability
- Link to J-Hooks in one of multiple color options to aid in pathway identification and organization
- Customized J-Hook trees can be easily assembled with various J-Hook sizes, colors and configurations
- nVent CADDY Cat HP components easily attach to any size nVent CADDY Cat HP J-Hook

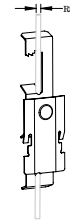
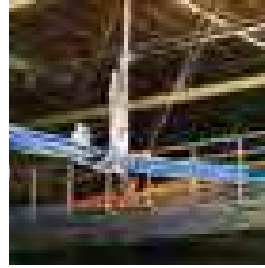

Material: Spring Steel
Finish: nVent CADDY Armour



Part Number	Article Number	Rod Size	Wire Size	Static Load
CATHP4Z34	181083	M4, M6, M8	4.8 – 6.4 mm	130 N
CATHP6Z34	181084	M8, M10, M12		130 N

Recommended for use with nVent CADDY Cat HP J-Hooks with a diameter of 2" (50 mm) or less.

NVENT CADDY CAT HP J-HOOK CLIP TO STRUT CLIP

- Easily attaches to the side of strut
- Requires no screws, rivets or special tools for assembly
- J-Hooks feature bendable locking tabs that lock on to nVent CADDY Cat HP components to provide rigidity and stability
- Link to J-Hooks in one of multiple color options to aid in pathway identification and organization
- Customized J-Hook trees can be easily assembled with various J-Hook sizes, colors and configurations
- nVent CADDY Cat HP components easily attach to any size nVent CADDY Cat HP J-Hook

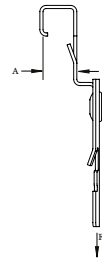

Material: Steel, Spring Steel
Finish: nVent CADDY Armour



Part Number	Article Number	A	Static Load	Certifications
CATHPESC	181082	10 mm	440 N	cULus, ITB

Datacom/Low Voltage

CABLE SUPPORT SYSTEMS

nVENT CADDY CAT HP J-HOOK CLIP TO PEDESTAL CLAMP

- Easy installation to pedestals used under raised floors
- Requires no screws, rivets or special tools for assembly
- J-Hooks feature bendable locking tabs that lock on to nVent CADDY Cat HP components to provide rigidity and stability
- Link to J-Hooks in one of multiple color options to aid in pathway identification and organization
- Customized J-Hook trees can be easily assembled with various J-Hook sizes, colors and configurations
- nVent CADDY Cat HP components easily attach to any size nVent CADDY Cat HP J-Hook

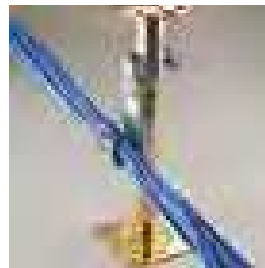

Material: Steel, Spring Steel
 Finish: Electrogalvanized, nVent CADDY Armour



Part Number	Article Number	Pedestal Size	Static Load
CATHPCD1B	181086	19 mm Square, 22.2 - 28.5 mm Round	70 N
CATHPCD2.5B	181088	25.4 mm Square	70 N

nVENT CADDY CAT HP J-HOOK ANGLE BRACKET

- Ideal for attaching to threaded rod, concrete, steel or wood surfaces
- Requires no screws, rivets or special tools for assembly
- J-Hooks feature bendable locking tabs that lock on to nVent CADDY Cat HP components to provide rigidity and stability
- Link to J-Hooks in one of multiple color options to aid in pathway identification and organization
- Customized J-Hook trees can be easily assembled with various J-Hook sizes, colors and configurations
- nVent CADDY Cat HP components easily attach to any size nVent CADDY Cat HP J-Hook

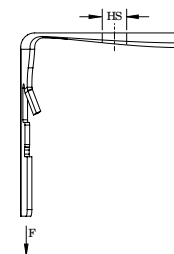

Material: Spring Steel
 Finish: nVent CADDY Armour



Part Number	Article Number	Hole Size	Static Load
CATHPAN	181065	4.7 mm	712 N
CATHPA4	181066	7.2 mm	667 N
CATHPA6	181067	10.4 mm	890 N

Datacom/Low Voltage

CABLE SUPPORT SYSTEMS

NVENT CADDY CAT HP J-HOOK STRAIGHT BRACKET

- Can be attached to various nVent CADDY fasteners or screwed directly to a wall
- Ideal for attaching to concrete, steel or wood surfaces
- Requires no screws, rivets or special tools for assembly
- J-Hooks feature bendable locking tabs that lock on to nVent CADDY Cat HP components to provide rigidity and stability
- Link to J-Hooks in one of multiple color options to aid in pathway identification and organization
- Customized J-Hook trees can be easily assembled with various J-Hook sizes, colors and configurations
- nVent CADDY Cat HP components easily attach to any size nVent CADDY Cat HP J-Hook

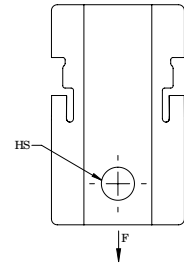

Material: Spring Steel
Finish: nVent CADDY Armour



Part Number	Article Number	Hole Size	Static Load
CATHPS4	181068	7 mm	890 N

NVENT CADDY CAT HP J-HOOK TREE MOUNT BRACKET

- Requires no screws, rivets or special tools for assembly
- J-Hooks feature bendable locking tabs that lock on to nVent CADDY Cat HP components to provide rigidity and stability
- Link to J-Hooks in one of multiple color options to aid in pathway identification and organization
- Customized J-Hook trees can be easily assembled with various J-Hook sizes, colors and configurations
- nVent CADDY Cat HP components easily attach to any size nVent CADDY Cat HP J-Hook

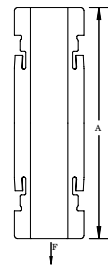

Material: Spring Steel
Finish: nVent CADDY Armour



Part Number	Article Number	A	Static Load	Certifications
CATHPTM	181069	111 mm	890 N	cULus, E30, E60, E90, ITB

Datacom/Low Voltage

CABLE SUPPORT SYSTEMS

NVENT CADDY CAT HP CABLE PULLER KIT

- Minimizes pulling tension per TIA 568-C.5.3.1 during the installation of high-performance data cables
- Includes retainer, screw, angle bracket, tree mount bracket, carabiner hook and beam clamp

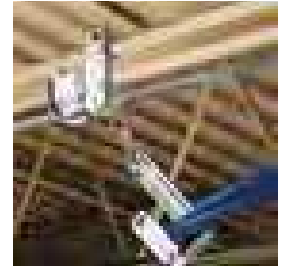

Material: Steel, Spring Steel
Finish: Pregalvanized, nVent CADDY Armour

Part Number	Article Number	Diameter
CATHPPLR	181093	50 mm

NVENT CADDY CAT HP WIRE RETAINER

- Replacement wire retainer for nVent CADDY Cat HP J-Hooks
- Provides 360 degree containment for cables

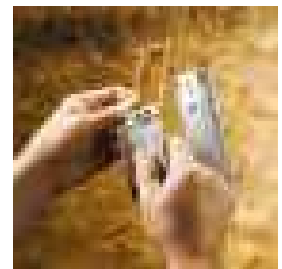
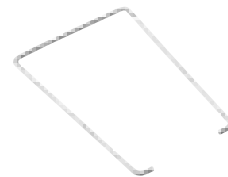

Material: Steel
Finish: Pregalvanized

Part Number	Article Number	Diameter
RET16B50	181271	25.0 mm
RET21B50	181272	33.3 mm
RET32B50	181273	50.0 mm
RET48B25	181274	75.0 mm
RET64B25	181275	100.0 mm

Datacom/Low Voltage

CABLE SUPPORT SYSTEMS

NVENT CADDY CAT CM DOUBLE J-HOOK

- Provides optimal support for high-performance data cable, up to and including Cat 5e, Cat 6, Cat 6A, Cat 7 and fibre optic
- System offers a convenient pathway for wires and cables
- Double J-Hooks can be mounted vertically along the same drop rod to create a tree configuration
- Allows addition of cables even when fixed flush to overhead decking
- Specially designed double J-Hook has large-diameter, rounded support surfaces
- Rounded edges help prevent over-bending and kinking of cables
- Ideal for retrofit applications where cable runs need to be routed around existing building infrastructure
- Compliant with NEC® and ANSI®/TIA structured cabling systems standards

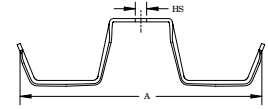

Material: Steel
Finish: Electrogalvanized



Part Number	Article Number	Cable Capacity, Cat 5e	Cable Capacity, Cat 6	Cable Capacity, Cat 6A	A	Area	Hole Size
CAT100CM	181976	70	50	30	185 mm	80 mm ²	9.5 mm

Area shown is the combined value for both sides. Divide by 2 for area of each side.

NVENT CADDY CAT 425 ADJUSTABLE CABLE SUPPORT

- Provides optimal support for high-performance data cable, up to and including Cat 5e, Cat 6, Cat 6A, Cat 7 and fibre optic
- Simple unlocking and locking of bar allows for additional cables to be added easily after installation
- Adjustable strap allows for multiple support sizes to reduce inventory
- Cost effective alternative to expensive cable tray
- cULus® Listed and complies with NEC® and TIA requirements for structured cabling systems
- Suitable for air handling spaces (plenum)

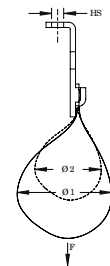
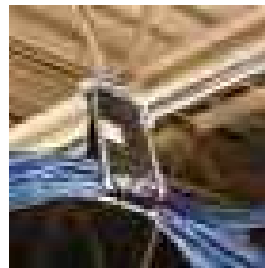

Material: Steel, Polyethylene
Finish: Electrogalvanized



Part Number	Article Number	Diameter	Area	Cable Capacity, Cat 5e	Cable Capacity, Cat 6	Cable Capacity, Cat 6A	Hole Size	Static Load	Certifications
CAT425	181130	100 mm, 150 mm	518 mm ²	425	325	210	7 mm	450 N	cULus, ITB

Datacom/Low Voltage

CABLE SUPPORT SYSTEMS

nVENT CADDY CAT 425 WALL MOUNT ADJUSTABLE CABLE SUPPORT

- Provides optimal support for high-performance data cable, up to and including Cat 5e, Cat 6, Cat 6A, Cat 7 and fibre optic
- Simple unlocking and locking of bar allows for additional cables to be added easily after installation
- Adjustable strap allows for multiple support sizes to reduce inventory
- Cost effective alternative to expensive cable tray
- cULus® Listed and complies with NEC® and TIA requirements for structured cabling systems
- Suitable for air handling spaces (plenum)

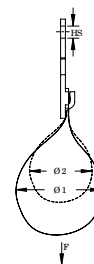

Material: Steel, Polyethylene
Finish: Electrogalvanized



Part Number	Article Number	Diameter	Area	Cable Capacity, Cat 5e	Cable Capacity, Cat 6	Cable Capacity, Cat 6A	Hole Size	Static Load	Certifications
CAT425WM	181880	100 mm, 150 mm	518 mm ²	425	325	210	7 mm	450 N	cULus, ITB

THREADED BRIDLE RING

- Combine bridle rings with other nVent CADDY fasteners to support cables from flange, purlin, drop wire, t-grid, etc.

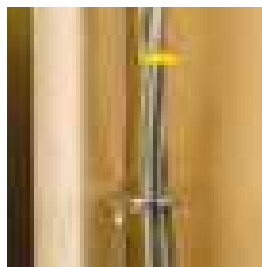

Material: Steel
Finish: Electrogalvanized



Part Number	Article Number	Diameter	Screw Diameter	Screw Type	Screw Length	Ultimate Static Load	Standard Packaging Quantity
PTB6	172921	12 mm	M6	Metal	32 mm	220 N	100 pc
PTB8	172922	16 mm	M8	Metal	32 mm	220 N	100 pc
GR50	172920	50 mm	M6	Metal	18 mm	220 N	100 pc

Bridle Rings not recommended for high performance cables. See nVent CADDY Cat HP J-Hook System.

Datacom/Low Voltage

CLIPS, CLAMPS AND RETAINERS

nVENT CADDY MILLE-TIE

- Suitable for heavy duty applications
- Maintains cable properties and conductor configuration
- Protects cable from crimping with "Intelligent Grip Technology"
- Cushions vibration
- No sharp edges
- One size fits all
- Reusable

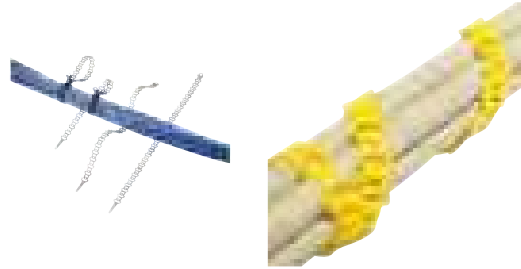

Material: Polyurethane
Temperature: -20 to 60 °C

Part Number	Article Number	Type	Length	Color
CATMTLS	181995	Low-Smoke/Halogen Free	300 mm	Yellow

QSC MULTI-CABLE CLIP FOR PIN DRIVERS

- Ideal for smaller runs of cables
- Flexible clip retains shape and allows for cables to be inserted after installation
- Rounded edges help prevent cable damage
- Cables are neatly installed providing a consistent and professional appearance
- Low-profile allows for installations in tight spaces
- Can be installed on ceilings and walls
- Designed to fit a variety of pin drivers
- Suitable for supporting wiring systems according to BS7671-1:2018 when installed in combination with other steel components



Material: Spring Steel
Finish: nVent CADDY Armour

Part Number	Article Number	Cable Capacity	A	B	Diameter 1 Ø1	Diameter 2 Ø2	Hole Size HS
QSC	182058	4	61 mm	18 mm	7 – 8 mm	8 – 12 mm	3 mm

QSC MULTI-CABLE CLIP

- Ideal for smaller runs of cables
- Flexible clip retains shape and allows for cables to be inserted after installation
- Rounded edges help prevent cable damage
- Cables are neatly installed providing a consistent and professional appearance
- Low-profile allows for installations in tight spaces
- Can be installed on ceilings and walls
- Suitable for supporting wiring systems according to BS7671-1:2018 when installed in combination with other steel components



Material: Polyurethane
Temperature: -20 to 60 °C

Part Number	Article Number	Cable Capacity	A	B	Diameter 1 Ø1	Diameter 2 Ø2	Hole Size HS
QSC4	182059	4	61 mm	18 mm	7 – 8 mm	8 – 12 mm	7 mm

Datacom/Low Voltage

CLIPS, CLAMPS AND RETAINERS

METAL PRESSURE CLIP, FIRE-RATED

- Includes insert for E30 fire rating according to DIN 4102-12
- Ideal for smaller runs of cable
- Flexible clip retains shape and allows for cables to be inserted after installation
- Rounded edges help prevent cable damage
- Cables are neatly installed providing a consistent and professional appearance
- Low-profile allows for installations in tight spaces

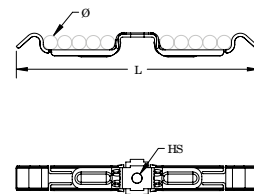
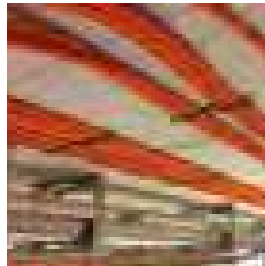

Material: Spring Steel
Finish: nVent CADDY Armour



Part Number	Article Number	Hole Size	Length
PKM10H6IN	182048	7.2 mm	171.5 mm
PKM16H6IN	182049	7.2 mm	233.5 mm

Fire rating test conducted with cable types listed. Equivalent halogen free safety cable can be used according to national guidelines.

E30 Fire Rating Power Cable Capacity				
Eucasafe (N)HXCH FE 180 E30				
Part Number	Number of Cores	Core Cross Section	Cable Diameter	Number of Cables
PKM10H6IN	4	1.5 mm ²	12.5 mm	8 Max
	3	1.5 mm ²	11.8 mm	8 Max
	2	1.5 mm ²	11.4 mm	8 Max
PKM16H6IN	4	1.5 mm ²	12.5 mm	12 Max
	3	1.5 mm ²	11.8 mm	12 Max
	2	1.5 mm ²	11.4 mm	14 Max

E30 Fire Rating Data Cable Capacity				
Eucasafe JE-H(St) Bd FE 180 E30				
Part Number	Number of Cores	Core Cross Section	Cable Diameter	Number of Cables
PKM10H6IN	4	1.5 mm ²	12.5 mm	8 Max
	3	1.5 mm ²	11.8 mm	8 Max
PKM16H6IN	4	1.5 mm ²	12.5 mm	12 Max
	3	1.5 mm ²	11.8 mm	12 Max

Datacom/Low Voltage

CLIPS, CLAMPS AND RETAINERS

METAL PRESSURE CLIP

- Ideal for smaller runs of cable
- Flexible clip retains shape and allows for cables to be inserted after installation
- Rounded edges help prevent cable damage
- Cables are neatly installed providing a consistent and professional appearance
- Low-profile allows for installations in tight spaces
- Suitable for supporting wiring systems according to BS7671-1:2018 when installed in combination with other steel components

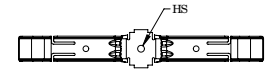
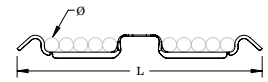

Material: Spring Steel
Finish: nVent CADDY Armour

Part Number	Article Number	Cable Capacity	Diameter	Hole Size	Length
PKM10H3	182044	10	10 mm Max	4.8 mm	171.5 mm
PKM10H6	182045	10	10 mm Max	7.1 mm	171.5 mm
PKM16H3	182046	16	10 mm Max	4.8 mm	233.5 mm
PKM16H6	182047	16	10 mm Max	7.1 mm	233.5 mm

Supports cable diameters up to 1/2" (13 mm) when installed with a standard 1/4" (6 mm) washer.

METAL PRESSURE CLIP INSERT

- Use with Metal Pressure Clip to obtain E30 fire rating according to DIN 4102-12

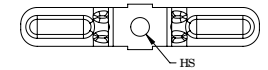
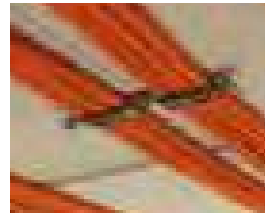

Material: Steel
Finish: Electrogalvanized



Part Number	Article Number	Hole Size
PKMININSERT	182051	7.2 mm

Datacom/Low Voltage

CLIPS, CLAMPS AND RETAINERS

METAL PRESSURE CLIP WITH NAIL GUN INSERT

- Clips onto nozzle of gas or battery-actuated nail guns allowing for hands-off installation at structure or from the floor using a pole
- Ideal for smaller runs of cable
- Flexible clip retains shape and allows for cables to be inserted after installation
- Rounded edges help prevent cable damage
- Cables are neatly installed providing a consistent and professional appearance
- Low-profile allows for installations in tight spaces
- Suitable for supporting wiring systems according to BS7671-1:2018 when installed in combination with other steel components

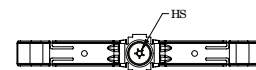
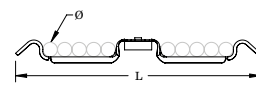
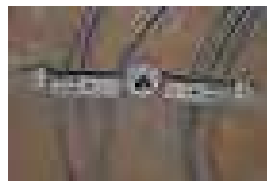

Material: Spring Steel; Nylon
Finish: nVent CADDY Armour

Part Number	Article Number	Diameter	Cable Capacity	Hole Size	Length
PKM10H3GBSF	182053	10 mm	10	3 mm	171.5 mm
PKM16H3GBSF	182054	10 mm	16	3 mm	233.5 mm

Supports cable diameters up to 1/2" (13 mm) when installed with a standard 1/4" (6 mm) washer.

Nail gun insert is compatible with BeA® CN60-688ES, Hilti® BX 3, GX 3, DEWALT® Trak-It C3, SPIT® PULSA 800E, 700, 1000 or equivalent nailers.

Please consult with the nail manufacturer to evaluate the static load of the nail and type of concrete used for the installation.

NAIL GUN INSERT

- Clips onto nozzle of gas or battery-actuated nail guns allowing for hands-off installation at structure or from the floor using a pole
- Ideal for fastening junction boxes, electrical boxes and cable trunking
- Helps prevent damage when fastening to brittle materials
- Works with nVent CADDY Metal Pressure Clip
- Halogen free

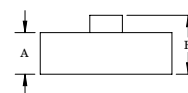
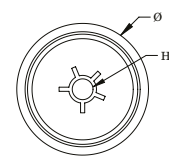

Material: Nylon

Part Number	Article Number	Hole Size HS	Diameter Ø	Height H	A
IGBSF	182052	3 mm	19 mm	8.5 mm	6 mm

Nail gun insert is compatible with BeA® CN60-688ES, Hilti® BX 3, GX 3, Powers® Trak-It C3, SPIT® PULSA 800E, 700, 1000 or equivalent nailers.

5. Structural Attachments



Structural Attachments

BEAM/PURLIN

300M UNIVERSAL BEAM CLAMP

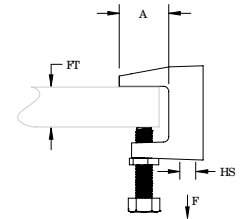
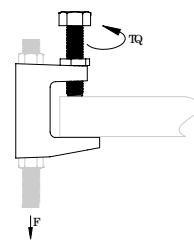

Material: Cast Iron
Finish: Electrogalvanized



Part Number	Article Number	Hole Size	Flange Thickness	A	Torque	Static Load	Certifications	Standard Packaging Quantity
Hole Type: Plain								
30009MM	389500	9 mm	18 mm Max	21 mm	14 N-m	1,200 N	ITB, VdS	100 pc
30011MM	389510	11 mm	20 mm Max	23 mm	14 N-m	2,500 N	FM, ITB, VdS	100 pc
30013MM	389520	13 mm	26 mm Max	35 mm	14 N-m	3,500 N	FM, ITB, VdS	80 pc
30017MM	389505	17 mm	28 mm Max	30 mm	14 N-m	5,500 N	FM, ITB, VdS	50 pc
Hole Type: Threaded								
300M6	386805	M6	18 mm Max	21 mm	14 N-m	1,200 N		140 pc
300M8	386810	M8	18 mm Max	21 mm	14 N-m	1,200 N	ITB, VdS	100 pc
300M10	386820	M10	20 mm Max	23 mm	14 N-m	2,500 N	FM, ITB, VdS	100 pc
300M12	386830	M12	26 mm Max	35 mm	14 N-m	3,500 N	FM, ITB, VdS	80 pc

Setscrew must be tightened and torqued onto the sloped side of the I-beam.

310M UNIVERSAL BEAM CLAMP, THICK FLANGE

- Universal beam clamp for thick beams

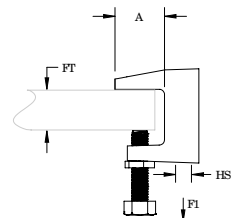
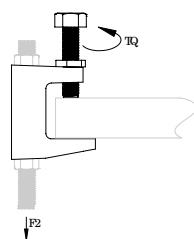
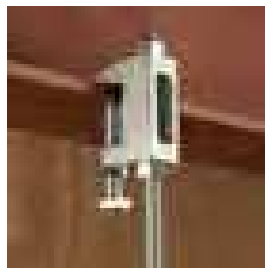

Material: Cast Iron
Finish: Electrogalvanized



Part Number	Article Number	Hole Size	Hole Type	Flange Thickness	A	Torque	Static Load 1	Static Load 2	Certifications
310M10	389890	M10	Threaded	31.8 mm Max	28.6 mm	7 N-m	2,200 N	1,100 N	cULus, FM, ITB, VdS G4080038
310M12	388890	M12	Threaded	31.8 mm Max	28.6 mm	15 N-m	4,200 N	3,300 N	cULus, FM, ITB, VdS G4080038

Setscrew must be tightened and torqued onto the sloped side of the I-beam.

Structural Attachments

BEAM/PURLIN

EBC BEAM CLAMP

- Easy installation to beam flanges
- One 10.5mm go-through hole allows the use of M6, M8 or M10 threaded rod, to attach any static load till 450N
- Featuring three M6 threaded holes to attach electrical boxes directly to the side or bottom of the beam

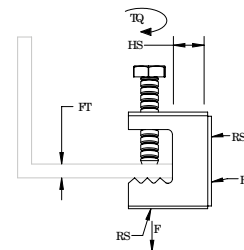

Material: Spring Steel
Finish: nVent CADDY Armour

Part Number	Article Number	Rod Size	Hole Size	Flange Thickness	Torque	Static Load	Certifications	Standard Packaging Quantity
EBC	170380	M6	10.5 mm	16 mm Max	3 N-m	450 N	ITB, CE	100 pc
EBCSP25	172430	M6	10.5 mm	16 mm Max	3 N-m	450 N	ITB, CE	10 x 25 pc

Setscrew must be tightened and torqued onto the sloped side of the I-beam.

BC BEAM CLAMP

- Threaded hole on back and bottom

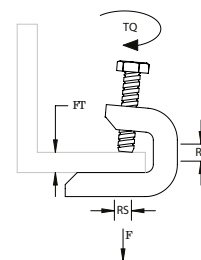

Material: Steel
Finish: Electrogalvanized

Part Number	Article Number	Rod Size	Flange Thickness	Torque	Static Load	Certifications	Standard Packaging Quantity
BC200M6	181180	M6	16 mm Max	3 N-m	440 N	ITB,	50 pc

Setscrew must be tightened and torqued onto the sloped side of the I-beam.

Structural Attachments

BEAM/PURLIN

BEAM CLAMP WITH SWIVEL

- Swivel beam clamp
- Suitable for mounting onto sloped steel structures
- Includes M10 nut and washer

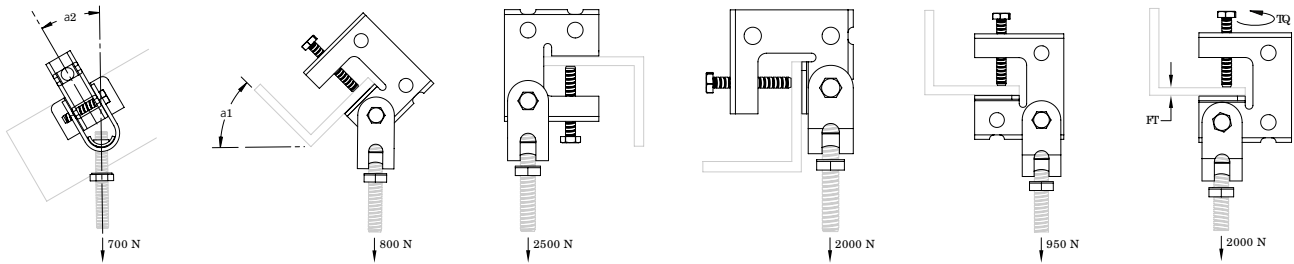

Material: Steel

Part Number	Article Number	Flange Thickness	Torque	Angle 1	Angle 2	Certifications
Finish: Electrogalvanized						
HB2	336030	24 mm Max	6 N-m	45° Min	30° Max	ITB
Finish: Hot-Dip Galvanized						
HB2HD	336040	24 mm Max	6 N-m	45° Min	30° Max	ITB

Setscrew must be tightened and torqued onto the sloped side of the I-beam.

35RS TWO HOLE RETAINER STRAP

- Retainer strap for beam clamps

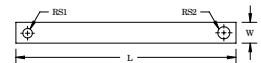
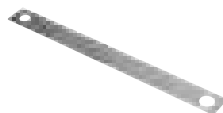

Material: Steel
Finish: Pregalvanized

Part Number	Article Number	Length	Width	Flange Width	Rod Size 1	Rod Size 2
035RS300	590240	350 mm	25 mm	300 mm Max	M10	M10

Field bend and use jam nut over hanger rod to secure.

Structural Attachments

BEAM/PURLIN

UBH CONCRETE BEAM CLAMP

- Complete beam clamp assembly for hanging from large I-shaped concrete beams

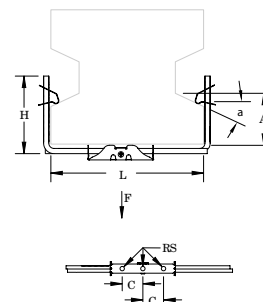
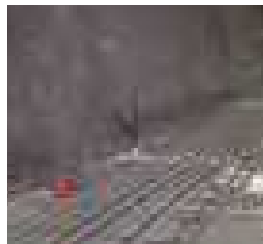
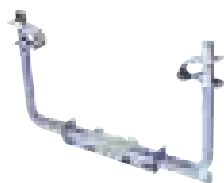

Material: Steel
Finish: Electrogalvanized

Part Number	Article Number	Rod Size	Length	Height	A	Angle	Static Load 1	Static Load 2
UBH350M8	190490	M8	200 – 350 mm	170 mm	3 – 110 mm	0° – 40°	750 N	500 N
UBH500M8	190500	M8	350 – 500 mm	210 mm	3 – 150 mm	0° – 40°	750 N	500 N

Static Load 1 represents 0° to 20° angle. Static Load 2 represents 20° to 40° angle.

UBHT CONCRETE BEAM CLAMP WITH CANTILEVER ARM

- Under beam attachment
- Rod extends past beam to support basket tray

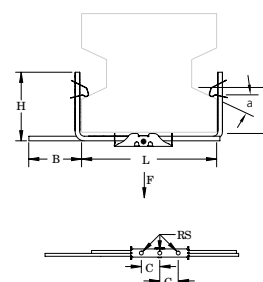
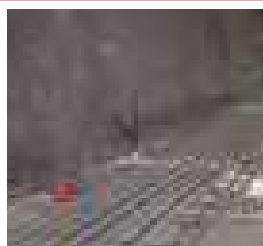
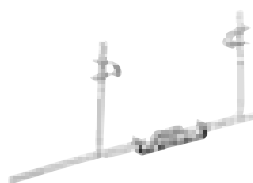

Material: Steel
Finish: Electrogalvanized

Part Number	Article Number	Length	Height	A	B	Angle	Static Load 1	Static Load 2
UBHT350	190510	200 – 350 mm	170 mm	3 – 110 mm	125 – 275 mm	0° – 40°	750 N	500 N
UBHT500	190520	350 – 500 mm	210 mm	3 – 150 mm	125 – 275 mm	0° – 40°	750 N	500 N

Static Load 1 represents 0° to 20° angle. Static Load 2 represents 20° to 40° angle.

WIRE CABLE TRAY CLIP FOR UBHT SERIES

- Easily attaches wire cable tray to UBHT Concrete Beam Clamp with Cantilever Arm
- No tools or fasteners needed; fast snap-on installation

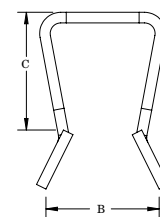
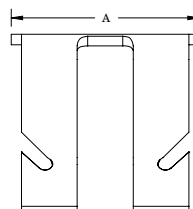

Material: Spring Steel
Finish: nVent CADDY Armour

Part Number	Article Number	A	B	C
UBHBTC	190620	18.1 mm	6.6 mm	12.6 mm

Structural Attachments

BEAM/PURLIN

2000 BEAM CLAMP KIT

- Light duty system
- Includes clamp and U channel

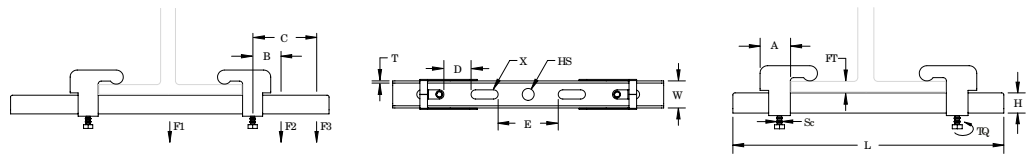

Material: Steel
Finish: Electrogalvanized

Part Number	Article Number	Length	A	B	C	D	E	Static Load 1	Static Load 2	Static Load 3
2200EG	570140	200 mm	25 mm	25 mm	65 mm	25 mm	30.5 mm	1,700 N	490 N	340 N
2300EG	570160	300 mm	25 mm	25 mm	65 mm	25 mm	30.5 mm	1,700 N	490 N	340 N
2400EG	570180	400 mm	25 mm	25 mm	65 mm	25 mm	30.5 mm	1,700 N	490 N	340 N

Height	Width	Thickness	Flange Thickness	Hole Size	Screw Diameter	Torque
12 mm	25 mm	2 mm	11 mm Max	11 mm	M6	30 N-m

For a secure grip the channel must extend to the outer edge of each beam clamp.

3000 BEAM CLAMP KIT

- Medium duty system
- Includes clamp and U channel

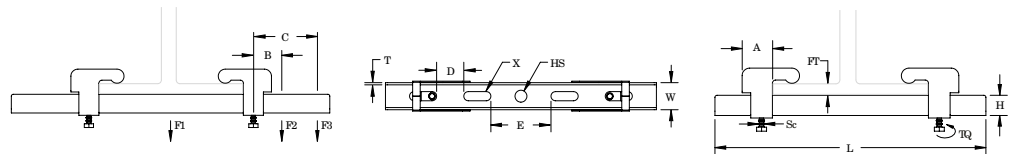
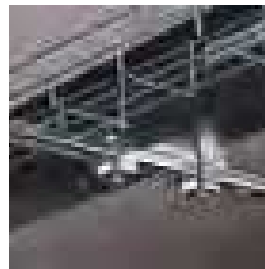

Material: Steel
Finish: Electrogalvanized

Part Number	Article Number	Length	Height	Width	Thickness	Flange Thickness	Hole Size	Static Load 1	Static Load 2	Static Load 3
3300EG	570410	300 mm	15 mm	30 mm	2.5 mm	15 mm Max	13 mm	3,700 N	490 N	390 N
3400EG	570420	400 mm	15 mm	30 mm	2.5 mm	15 mm Max	13 mm	3,700 N	490 N	390 N
3500EG	570430	500 mm	15 mm	30 mm	2.5 mm	15 mm Max	13 mm	3,700 N	490 N	390 N
3600EG	570440	600 mm	15 mm	30 mm	2.5 mm	15 mm Max	13 mm	3,700 N	490 N	390 N

A	B	C	D	E	X	Screw Diameter
40 mm	100 mm	150 mm	25 mm	31.5 mm	10.5 x 25 mm	M8

Structural Attachments

BEAM/PURLIN

5000 BEAM CLAMP KIT

- C-Channel system
- Includes beam clamp and channel

A	Static Load F1	Static Load F2
100 mm	3500 N	850 N
200 mm	1750 N	400 N
300 mm	1100 N	250 N
400 mm	800 N	200 N
500 mm	700 N	175 N
600 mm	500 N	125 N

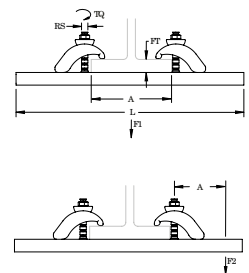
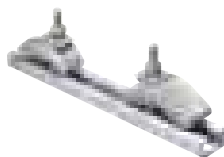

Part Number	Article Number	Length	Channel Type	Rod Size	Flange Thickness	Torque
Material: Stainless Steel 304 (EN 1.4301)						
5400S4	335060	400 mm	E5	M10	3 – 30 mm	30 N-m
5600S4	335080	600 mm	E5	M10	3 – 30 mm	30 N-m
Material: Steel – Finish: Hot-Dip Galvanized						
5300HD	335000	300 mm	E5	M10	3 – 30 mm	30 N-m
5400HD	335010	400 mm	E5	M10	3 – 30 mm	30 N-m
5500HD	335020	500 mm	E5	M10	3 – 30 mm	30 N-m
5600HD	335030	600 mm	E5	M10	3 – 30 mm	30 N-m

6000 BEAM CLAMP KIT

- Back-to-back welded channels provide a smooth and easy adjustable fixing over the complete length of the channel
- Pressure clamps grip the strut channel between two lips, protecting it from turning
- Safe heavy duty fixing system for cable tray, duct or pipe

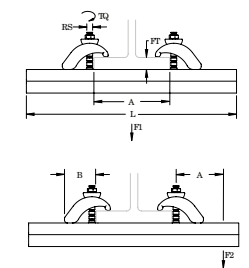
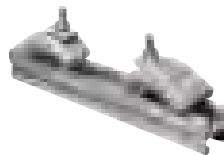

Material: Steel
Finish: Hot-Dip Galvanized

Part Number	Article Number	Length	Strut Type	Rod Size	Flange Thickness	B	Torque
6300AAHD	330100	300 mm	AA (83 x 41 mm)	M10	3 – 30 mm	60 mm	30 N-m
6300CCHD	330000	300 mm	CC (41 x 41 mm)	M10	3 – 30 mm	60 mm	30 N-m
6400AAHD	330110	400 mm	AA (83 x 41 mm)	M10	3 – 30 mm	60 mm	30 N-m
6400CCHD	330010	400 mm	CC (41 x 41 mm)	M10	3 – 30 mm	60 mm	30 N-m
6500AAHD	330120	500 mm	AA (83 x 41 mm)	M10	3 – 30 mm	60 mm	30 N-m
6500CCHD	330020	500 mm	CC (41 x 41 mm)	M10	3 – 30 mm	60 mm	30 N-m
6600AAHD	330130	600 mm	AA (83 x 41 mm)	M10	3 – 30 mm	60 mm	30 N-m
6600CCHD	330030	600 mm	CC (41 x 41 mm)	M10	3 – 30 mm	60 mm	30 N-m
6800AAHD	330140	800 mm	AA (83 x 41 mm)	M10	3 – 30 mm	60 mm	30 N-m

Strut Type	A	Static Load F1	Static Load F2
CC	200 mm	4000 N	1100 N
	300 mm	3000 N	750 N
	400 mm	2250 N	550 N
	500 mm	1800 N	450 N
	600 mm	1500 N	350 N

Strut Type	A	Static Load F1	Static Load F2
AA	200 mm	7000 N	3250 N
	300 mm	7000 N	2250 N
	400 mm	7000 N	1750 N
	500 mm	5500 N	1400 N
	600 mm	4500 N	1150 N

Structural Attachments

BEAM/PURLIN

6000 BEAM CLAMP KIT WITH SWIVEL

- Strut channel system, complete kit with swivel adapter
- Includes AS channel and two beam clamps
- Beam clamps grip laterally over the channel preventing it from twisting

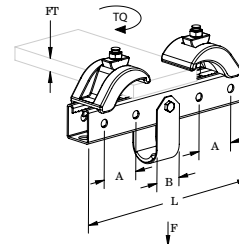
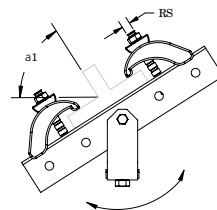
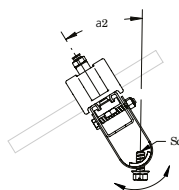
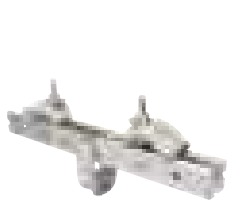

Material: Steel
Finish: Hot-Dip Galvanized, Electrogalvanized

Part Number	Article Number	Length	Rod Size	Flange Thickness	Angle 1	Angle 2	A	B	Screw Diameter	Torque
6300SWHDEG	336000	300 mm	M10	3 – 30 mm	45° Max	30° Max	50 mm	35 mm	M10	30 N-m
6500SWHDEG	336020	500 mm	M10	3 – 30 mm	45° Max	30° Max	50 mm	35 mm	M10	30 N-m

Load ratings apply for installations under a horizontal beam.

D1 PURLIN CLAMP

- Straight design
- Hangs threaded rod from purlins

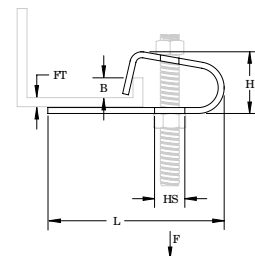
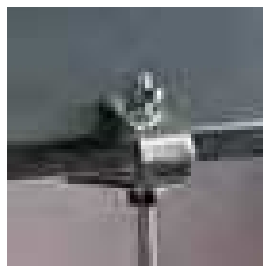

Material: Steel
Finish: Electrogalvanized

Part Number	Article Number	Flange Thickness	Hole Size	Height	Length	B	Static Load
D1	336280	4 mm Max	11 mm	36 mm	90 mm	22 mm Max	600 N

Structural Attachments

BEAM/PURLIN

122 SERIES Z PURLIN CLIP

- Hammer-on clip compensates for angle of purlin
- Provides a portable hole
- Side mount

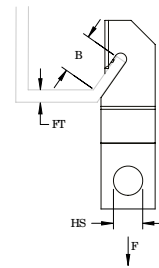

Material: Spring Steel
Finish: nVent CADDY Armour



Part Number	Article Number	Hole Size	Flange Thickness	B	Static Load
122	171690	6.8 mm	2.8 mm Max	15 mm Min	450 N

123 SERIES Z PURLIN CLIP

- Hammer-on clip compensates for angle of purlin
- Provides method for attaching conduit and boxes to purlin
- Bottom mount

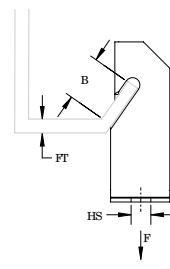

Material: Spring Steel
Finish: nVent CADDY Armour



Part Number	Article Number	Hole Size	Flange Thickness	B	Static Load
123	171700	6.8 mm	1.5 – 2.5 mm	15 mm Min	450 N

AF SERIES Z PURLIN CLIP

- Angle flange clip for wire or chain suspensions from Z purlins
- Installs from floor with VAFT tool and conduit

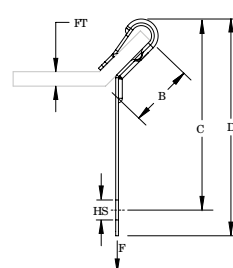
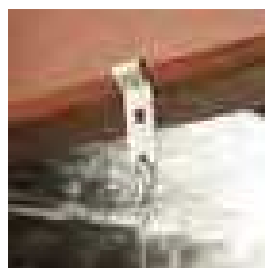
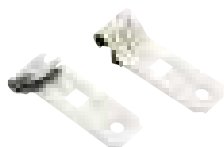

Material: Spring Steel
Finish: nVent CADDY Armour



Part Number	Article Number	Hole Size	Flange Thickness	B	C	D	Static Load
AF14	179860	7.1 mm	1.5 – 6.0 mm	20 mm Min	65 mm	74 mm	440 N

Structural Attachments

BEAM/PURLIN

J SERIES C PURLIN CLIP

- Provides an attachment for nVent CADDY Speed Link assemblies, wire, S-hooks, or chain from purlin and bar joist
- Requires only a hammer to install

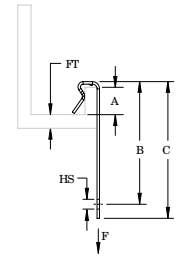

Material: Spring Steel
Finish: nVent CADDY Armour

Part Number	Article Number	Flange Thickness	Hole Size	A	B	C	Static Load	Standard Packaging Quantity
J1	170370	1.5 – 4.0 mm	6.8 mm	10 mm Min	42 mm	50 mm	700 N	100 pc
J2	171590	4.0 – 6.5 mm	6.8 mm	10 mm Min	42 mm	50 mm	700 N	100 pc

PW2 SERIES C PURLIN CLIP

- Provides an attachment for nVent CADDY Speed Link assemblies, wire, S-hooks, or chain from roll-lip purlin

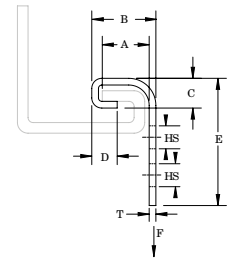

Material: Steel
Finish: nVent CADDY Armour

Part Number	Article Number	Hole Size	Thickness	A	B	C	D	E	Static Load
PW2	175590	6.8 mm	2 mm	12.5 mm	19.5 mm	12.5 mm	7.8 mm	37.5 mm	700 N

VF SERIES C PURLIN CLIP

- Provides an attachment for nVent CADDY Speed Link assemblies, wire, S-hooks, or chain from purlin and bar joist
- Installs from floor with VAFT tool and conduit

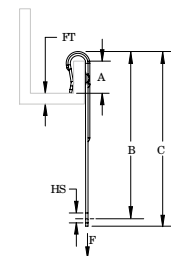

Material: Spring Steel
Finish: nVent CADDY Armour



Part Number	Article Number	Flange Thickness	A	B	C	Hole Size	Static Load	Standard Packaging Quantity
VF14	179850	1.5 – 6.0 mm	20 mm Min	80 mm	90 mm	7.1 mm	700 N	100 pc

Structural Attachments

BEAM/PURLIN

VAFT INSTALLATION TOOL FOR PURLIN CLIPS

- Installation tool for VF & AF assemblies
- Used to install the AF or VF rod clips from the floor

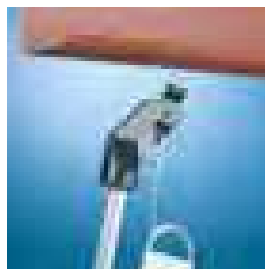

Material: Steel

Part Number	Article Number	Product
VAFT	190330	Installation Tool

HAMMER-ON FLANGE CLIP, BOTTOM MOUNT

- Can be used to support boxes, fixtures or other applications from beam flanges
- Assorted attachment points provided to reduce inventory
- Requires only a hammer to install

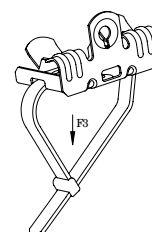
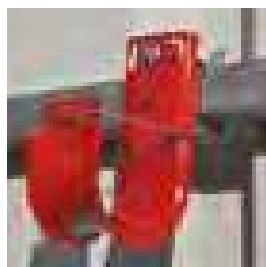
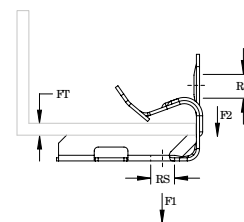

Part Number	Article Number	Flange Thickness	Rod Size	Static Load 1	Static Load 2	Static Load 3	Certifications	Standard Packaging Quantity
Material: Spring Steel – Finish: nVent CADDY Armour								
EM24	170050	3 – 8 mm	M6	450 N	110 N	330 N	ITB, CE	100 pc
EM24R5	191026	3 – 8 mm	M6	450 N	110 N	330 N	CE	8 x 5 pc
EM24SP25	172170	3 – 8 mm	M6	450 N	110 N	330 N	CE	10 x 25 pc
EM58	170060	8 – 14 mm	M6	450 N	110 N	330 N	ITB, CE	100 pc
EM58R5	191027	8 – 14 mm	M6	450 N	110 N	330 N	CE	8 x 5 pc
EM58SP25	172180	8 – 14 mm	M6	450 N	110 N	330 N	CE	10 x 25 pc
EM912	170070	14 – 20 mm	M6	450 N	110 N	330 N	ITB, CE	100 pc
EM912SP25	175760	14 – 20 mm	M6	450 N	110 N	330 N	CE	10 x 25 pc
EM1318	170075	21 – 28 mm	M6	450 N	110 N	330 N	cULus	50 pc
Material: Stainless Steel 301 (EN 1.4310)								
EM24S1	179720	3 – 8 mm	M6	200 N	110 N	200 N		100 pc
EM58S1	179730	8 – 14 mm	M6	200 N	110 N	200 N		100 pc
EM912S1	179740	14 – 20 mm	M6	200 N	110 N	200 N		100 pc

Structural Attachments

BEAM/PURLIN

HAMMER-ON FLANGE CLIP, BOTTOM MOUNT WITH STUD

- Can be used to support boxes, fixtures or other applications from beam flanges
- Captive threaded stud minimizes the need for additional hardware
- Assorted attachment points provided to reduce inventory
- Requires only a hammer to install

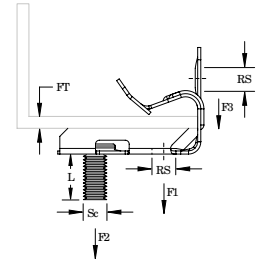

Part Number	Article Number	Flange Thickness	Rod Size	Screw Diameter	Screw Length	Static Load 1	Static Load 2	Static Load 3	Certifications	Standard Packaging Quantity
Material: Spring Steel – Finish: nVent CADDY Armour										
EM24SM	170530	3 – 8 mm	M6	M6	11 mm	450 N	330 N	110 N	ITB	100 pc
EM24SM16	160440	3 – 8 mm	M6	M6	16 mm	450 N	330 N	110 N		100 pc
EM24SM16SP10	172220	3 – 8 mm	M6	M6	16 mm	450 N	330 N	110 N		10 x 10 pc
EM58SM	172060	8 – 14 mm	M6	M6	11 mm	450 N	330 N	110 N	ITB	100 pc
EM58SM16	160450	8 – 14 mm	M6	M6	16 mm	450 N	330 N	110 N		100 pc
EM58SM16R5	191044	8 – 14 mm	M6	M6	16 mm	450 N	330 N	110 N		8 x 5 pc
EM58SM16SP10	172230	8 – 14 mm	M6	M6	16 mm	450 N	330 N	110 N		10 x 10 pc
EM912SM	171850	14 – 20 mm	M6	M6	11 mm	450 N	330 N	110 N	ITB	100 pc
EM912SM16	160460	14 – 20 mm	M6	M6	16 mm	450 N	330 N	110 N		100 pc
EM1318SM	171855	21 – 28 mm	M6	M6	11 mm	450 N	330 N	110 N	cULus	50 pc
Material: Stainless Steel 301 (EN 1.4310)										
EM24SS1	179750	3 – 8 mm	M6	M6	11 mm	200 N	200 N	110 N		100 pc
EM58SMS1	179760	8 – 14 mm	M6	M6	11 mm	200 N	200 N	110 N		100 pc
EM912SS1	179770	14 – 20 mm	M6	M6	11 mm	200 N	200 N	110 N		100 pc

Structural Attachments

BEAM/PURLIN

HAMMER-ON FLANGE CLIP, SIDE MOUNT

- Provides an attachment for wire, S-hooks, chain, nVent CADDY Speed Link or other assemblies to flanges and profiles
- Fits most beams
- Installs with just a hammer

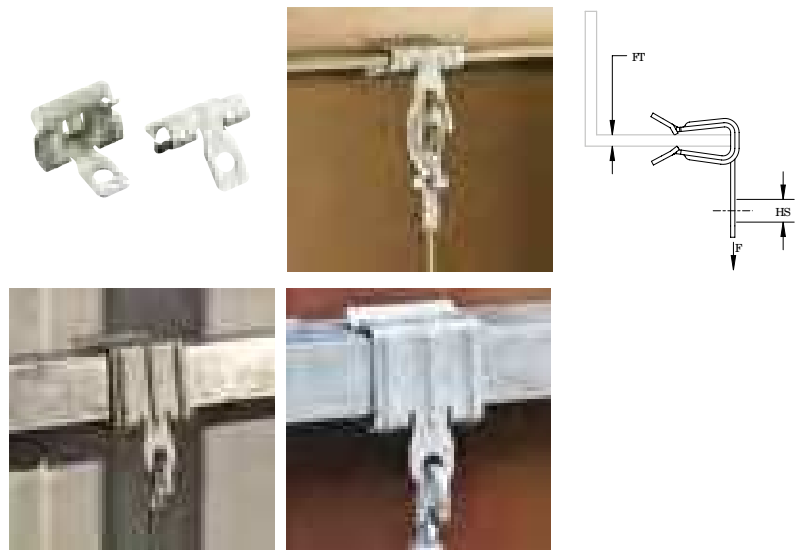

Part Number	Article Number	Flange Thickness	Hole Size	Static Load	Certifications	Standard Packaging Quantity
Material: Spring Steel – Finish: nVent CADDY Armour						
2H4	170010	2 – 3 mm	7.1 mm	700 N	cULus, ITB	100 pc
4H24	170020	3 – 8 mm	7.1 mm	900 N	cULus, ITB, CE	100 pc
4H24R5	191018	3 – 8 mm	7.1 mm	900 N	cULus, CE	10 x 5 pc
4H24SP25	172320	3 – 8 mm	7.1 mm	900 N	CE	10 x 25 pc
4H58	170030	8 – 14 mm	7.1 mm	900 N	cULus, ITB, CE	100 pc
4H58R5	191019	8 – 14 mm	7.1 mm	900 N	cULus, CE	10 x 5 pc
4H58SP25	172350	8 – 14 mm	7.1 mm	900 N	CE	10 x 25 pc
4H912	170040	14 – 20 mm	7.1 mm	900 N	cULus, ITB, CE	100 pc
4H912R5	191045	14 – 20 mm	7.1 mm	900 N	cULus, CE	10 x 5 pc
4H912SP25	172380	14 – 20 mm	7.1 mm	900 N	CE	10 x 25 pc
4H1318	170045	21 – 28 mm	7.1 mm	900 N	cULus	50 pc
Material: Stainless Steel 301 (EN 1.4310)						
4H24S1	179610	3 – 8 mm	7.1 mm	650 N		100 pc
4H58S1	179620	8 – 14 mm	7.1 mm	650 N		100 pc
4H912S1	179630	14 – 20 mm	7.1 mm	650 N		100 pc

HAMMER-ON FLANGE CLIP, TWO HOLE SIDE MOUNT

- Attaches electrical box to beam



Material: Steel
Finish: nVent CADDY Armour

Part Number	Flange Thickness	Hole Size	C	Static Load
350000	3 – 6 mm	5.1 mm	30 mm	150 N

Structural Attachments

BEAM/PURLIN

HAMMER-ON FLANGE CLIP, VERTICAL MOUNT

- Can be used to support boxes, fixtures or other applications from beam flanges
- Fits most beams
- Requires only a hammer to install

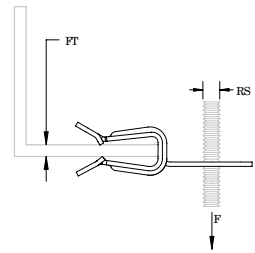

Material: Spring Steel
Finish: nVent CADDY Armour

Part Number	Article Number	Flange Thickness	Rod Size	Static Load	Certifications
4H24I	170150	3 – 8 mm	M6	150 N	ITB
4H58I	170250	8 – 14 mm	M6	150 N	ITB

HAMMER-ON FLANGE CLIP, VERTICAL MOUNT WITH STUD

- Can be used to support boxes, fixtures or other applications from beam flanges
- Captive threaded stud minimizes the need for additional hardware
- Fits most beams
- Requires only a hammer to install

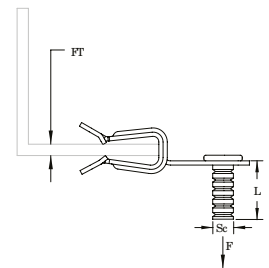

Material: Spring Steel, Steel
Finish: nVent CADDY Armour, Electrogalvanized

Part Number	Article Number	Flange Thickness	Screw Diameter	Screw Length	Static Load
4H24IM11	170140	3 – 8 mm	M6	11 mm	150 N
4H58IM11	170160	8 – 14 mm	M6	11 mm	150 N

BC-MA ROD TO BEAM CLAMP

- Attaches rod to beam flange
- Uses EBC as attachment to beam

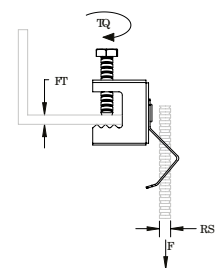
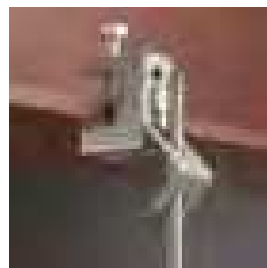

Material: Spring Steel
Finish: nVent CADDY Armour

Part Number	Article Number	Rod Size	Flange Thickness	Torque	Static Load
EBCM6MA	172990	M6	16 mm Max	3 N-m	250 N
EBCM8MA	173000	M8	16 mm Max	3 N-m	250 N

Structural Attachments

BEAM/PURLIN

H-TI/T ROD TO FLANGE CLIP

- Suspends threaded rod from beam flanges
- Threaded rod hanger can swivel to provide a vertical dropdown
- Requires only a hammer to install

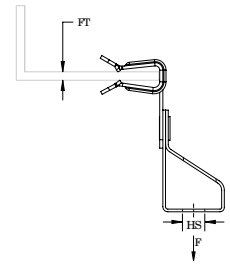
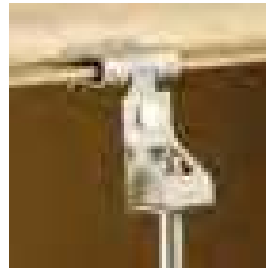

Material: Spring Steel
Finish: nVent CADDY Armour

Part Number	Article Number	Hole Size	Hole Type	Flange Thickness	Static Load	Certifications	Standard Packaging Quantity
160000	160000	11 mm	Plain	2 – 3 mm	700 N	ITB	100 pc
160010	160010	11 mm	Plain	3 – 8 mm	900 N	ITB	100 pc
T1058	160020	11 mm	Plain	8 – 14 mm	900 N	ITB	100 pc
160030	160030	11 mm	Plain	14 – 20 mm	900 N	ITB	100 pc
M6TI4	174810	M6	Threaded	2 – 3 mm	700 N	ITB	100 pc
M6TI24	174820	M6	Threaded	3 – 8 mm	900 N	ITB	100 pc
M6TI24R5	191024	M6	Threaded	3 – 8 mm	900 N		10 x 5 pc
M6TI58	174830	M6	Threaded	8 – 14 mm	900 N	ITB	100 pc
M6TI912	174840	M6	Threaded	14 – 20 mm	900 N	ITB	100 pc
M8TI4	174900	M8	Threaded	2 – 3 mm	700 N	ITB	100 pc
M8TI24	174910	M8	Threaded	3 – 8 mm	900 N	ITB	100 pc
M8TI58	174920	M8	Threaded	8 – 14 mm	900 N	ITB	100 pc
M8TI912	174930	M8	Threaded	14 – 20 mm	900 N	ITB	100 pc
M10TI4	174990	M10	Threaded	2 – 3 mm	700 N		100 pc
M10TI24	175000	M10	Threaded	3 – 8 mm	900 N	ITB	100 pc
M10TI58	175010	M10	Threaded	8 – 14 mm	900 N	ITB	100 pc
M10TI912	175020	M10	Threaded	14 – 20 mm	900 N	ITB	100 pc

NVENT CADDY ROD LOCK SPRING STEEL ROD HANGER TO BEAM CLAMP

- Suspends threaded rod from beam flanges
- Threaded rod hanger can swivel to provide a vertical dropdown
- Easy "push-to-install" design allows installers to simply push the threaded rod through the mounting hole, instantly holding it in position
- Prefabricated assemblies easily lift and lock into place, helping to save time and money
- Works with slightly damaged threads and minor burrs on threaded rod ends
- Design includes a release mechanism that works with pliers

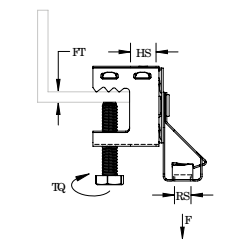

Material: Spring Steel
Finish: nVent CADDY Armour

Part Number	Article Number	Rod Size	Flange Thickness	Hole Size	Torque	Static Load
4QTIBC	170381	M6	16 mm Max	11 mm	3 N-m	300 N

Structural Attachments

BEAM/PURLIN

nVENT CADDY ROD LOCK SPRING STEEL ROD HANGER TO FLANGE CLIP

- Suspends threaded rod from beam flanges
- Threaded rod hanger can swivel to provide a vertical dropdown
- Requires only a hammer to install
- Easy “push-to-install” design allows installers to simply push the threaded rod through the mounting hole, instantly holding it in position
- Prefabricated assemblies easily lift and lock into place, helping to save time and money
- Works with slightly damaged threads and minor burrs on threaded rod ends
- Design includes a release mechanism that works with pliers

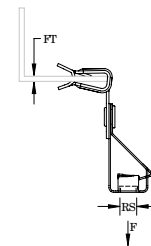
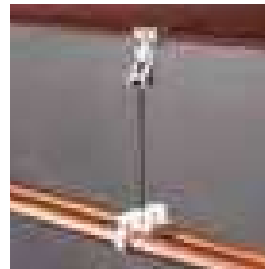

Material: Spring Steel
Finish: nVent CADDY Armour

Part Number	Article Number	Rod Size	Flange Thickness	Static Load
4QT14	174842	M6	2 – 3 mm	300 N
4QT124	174841	M6	3 – 8 mm	300 N
4QT158	174843	M6	8 – 14 mm	300 N
4QT1912	174844	M6	14 – 20 mm	300 N

122-TI/T ROD TO Z PURLIN CLIP

- Hammer-on clip compensates for angle of purlin
- Provides method for attaching rod to purlin

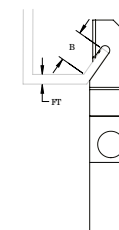
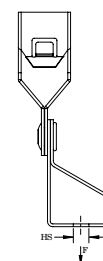

Material: Spring Steel
Finish: nVent CADDY Armour

Part Number	Article Number	Hole Size	Hole Type	Flange Thickness	B	Static Load
122M6TI	174890	M6	Threaded	2.8 mm Max	15 mm Min	450 N
122M8TI	174980	M8	Threaded	2.8 mm Max	15 mm Min	450 N
122M10TI	175070	M10	Threaded	2.8 mm Max	15 mm Min	450 N

Structural Attachments

BEAM/PURLIN

nVent CADDY ROD LOCK SPRING STEEL ROD HANGER TO C PURLIN CLIP

- Attaches to joists and C purlin
- Supports threaded rod
- Threaded rod hanger can swivel to provide a vertical dropdown
- Easy “push-to-install” design allows installers to simply push the threaded rod through the mounting hole, instantly holding it in position
- Prefabricated assemblies easily lift and lock into place, helping to save time and money
- Works with slightly damaged threads and minor burrs on threaded rod ends
- Design includes a release mechanism that works with pliers

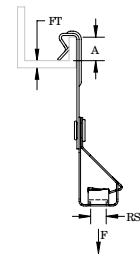

Material: Spring Steel
Finish: nVent CADDY Armour

Part Number	Article Number	Rod Size	Flange Thickness	A	Static Load
J1M6QTI	174881	M6	1.5 – 4.0 mm	10 mm Max	300 N
J2M6QTI	174882	M6	4.0 – 6.5 mm	10 mm Max	300 N

J-TI/T ROD TO C PURLIN CLIP

- Attaches to joists and C purlin
- Supports threaded rod
- Threaded rod hanger can swivel to provide a vertical dropdown

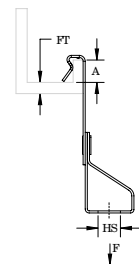

Material: Spring Steel
Finish: nVent CADDY Armour

Part Number	Article Number	Hole Size	Hole Type	Flange Thickness	A	Static Load	Standard Packaging Quantity
J1M6TI	174870	M6	Threaded	1.5 – 4.0 mm	10 mm Min	700 N	100 pc
J2M6TI	174880	M6	Threaded	4.0 – 6.5 mm	10 mm Min	700 N	100 pc
J1M8TI	174960	M8	Threaded	1.5 – 4.0 mm	10 mm Min	700 N	100 pc
J2M8TI	174970	M8	Threaded	4.0 – 6.5 mm	10 mm Min	700 N	100 pc
J1M10TI	175050	M10	Threaded	1.5 – 4.0 mm	10 mm Min	700 N	100 pc
J2M10TI	175060	M10	Threaded	4.0 – 6.5 mm	10 mm Min	700 N	100 pc
J1T10	160220	11 mm	Plain	1.5 – 4.0 mm	10 mm Min	700 N	100 pc
J2T10	160230	11 mm	Plain	4.0 – 6.5 mm	10 mm Min	700 N	100 pc

Structural Attachments

BEAM/PURLIN

PW2-TI/T ROD TO C PURLIN CLIP

- For suspending services from roll-lip purlins

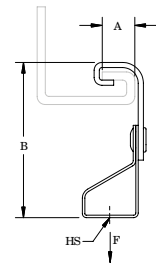

Material: Steel, Spring Steel
Finish: nVent CADDY Armour

Part Number	Article Number	Hole Size	Hole Type	A	B	Static Load
PW2M6TIIN	175600	M6	Threaded	12.5 mm	52 mm Min	700 N
PW2M8TIIN	175610	M8	Threaded	12.5 mm	52 mm Min	700 N
PW2M10TIIN	175620	M10	Threaded	12.5 mm	52 mm Min	700 N

325M STEEL SIDE BEAM ATTACHMENT

- Fastens to the wall or the side of a joist to support hanger rod

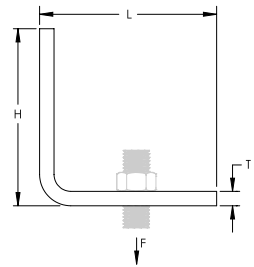
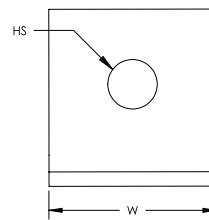

Material: Steel
Finish: Hot-Dip Galvanized

Part Number	Article Number	Hole Size	Height	Length	Width	Thickness	Static Load
325M10HD	589295	11 mm	50 mm	50 mm	50 mm	5 mm	2,000 N
325M12HD	589296	14 mm	50 mm	50 mm	50 mm	6 mm	3,000 N

Follow fastener manufacturer's recommended shear and pull-out strength when fastening to the structure. Fastener not included. Install in accordance with applicable code.

Structural Attachments

BEAM/PURLIN

38 OFFSET STEEL EYE SOCKET ROD HANGER

- Structural attachment used to join hanger rod to a structure
- Provides full vertical rod adjustment

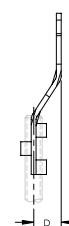
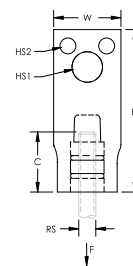
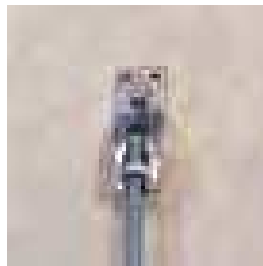

Material: Steel
Finish: Electrogalvanized



Part Number	Article Number	Rod Size	Pipe Size	Hole Size 1	Hole Size 2	Height	Width	C	D	Static Load
038M0010EG	598290	M10	100 mm Max	13 mm	6.7 mm	85 mm	29 mm	30.6 mm	19 mm	1,112 N

Load rating dependent on wood structure strength. For 3/8" rod through 2" pipe, use two Model #43 Wood Drive Screws. For 3/8" rod through 4" pipe, use one Model #42 1/2" x 3" Lag Screw.

TDH TRAPEZOIDAL DECK HANGER

- Easy install
- If thread connection is required, use square nut THHM and snap in
- Use TDHP perforation tool to punch hole in decking

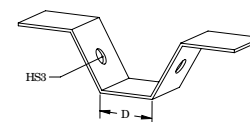
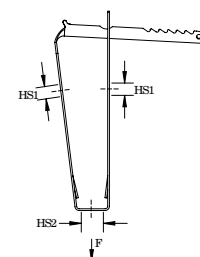

Ceiling Thickness	Static Load F
0,63 mm - 0,70 mm	600 N
0,71 mm - 0,80 mm	700 N
0,81 mm - 1,00 mm	800 N
1,01 mm - 1,20 mm	1000 N
1,21 mm - 1,50 mm	1200 N
> 1,50 mm	1500 N

Material: Spring Steel
Finish: nVent CADDY Armour

Part Number	Article Number	Hole Size 1	Hole Size 2	Hole Size 3	D	Certifications
TDH	179920	6.8 mm	14 mm	10.5 mm	50 mm Max	ITB

Structural Attachments

DECK

TDHM TRAPEZOIDAL DECK HANGER WITH FIXED NUT

- Easy install
- Use TDHP perforation tool to punch hole in decking

Ceiling Thickness	Static Load F
0,63 mm - 0,70 mm	600 N
0,71 mm - 0,80 mm	700 N
0,81 mm - 1,00 mm	800 N
1,01 mm - 1,20 mm	1000 N
1,21 mm - 1,50 mm	1200 N
> 1,50 mm	1500 N

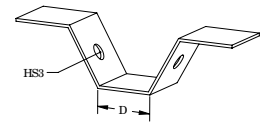
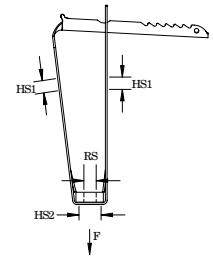

Material: Spring Steel
Finish: nVent CADDY Armour

Part Number	Article Number	Rod Size	Hole Size 1	Hole Size 2	Hole Size 3	D	Certifications
TDHM6	179930	M6	6.8 mm	14 mm	10.5 mm	50 mm Max	ITB
TDHM8	179940	M8	6.8 mm	14 mm	10.5 mm	50 mm Max	ITB
TDHM10	179950	M10	6.8 mm	14 mm	10.5 mm	50 mm Max	ITB

TDHP TRAPEZOIDAL DECK HOLE PUNCH

- Includes springs for quick release
- Height adjustable
- Replacement die set available

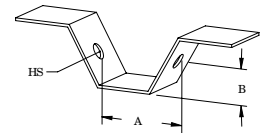
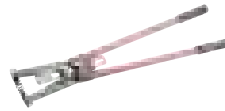

Material: Steel

Part Number	Article Number	Hole Size	A	B
TDHP2	159441	10.5 mm	40 – 100 mm	12 – 80 mm

REPLACEMENT DIE FOR TDHP TRAPEZOIDAL DECK HOLE PUNCH

- Includes two punches with springs, nuts and washers

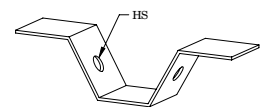

Material: Steel

Part Number	Article Number	Hole Size
TDHP2PR10	159442	10.5 mm

Structural Attachments

DECK

TBHK TRAPEZOIDAL DECK HANGER

- Requires separate cross bolt and nut
- Use TDHP perforation tool to punch hole in decking

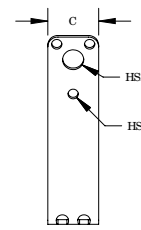
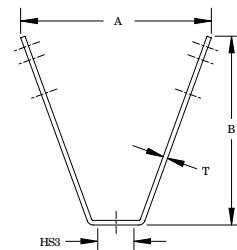
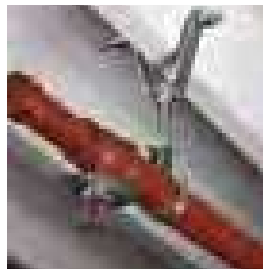

Material: Steel
Finish: Electrogalvanized

Part Number	Article Number	A	B	C	Thickness	Hole Size 1	Hole Size 2	Hole Size 3	Certifications
TBHK	597581	97 mm	91.5 mm	25 mm	2.5 mm	10.5 mm	5 mm	10.5 mm	FM, ITB, VdS

TBHKM TRAPEZOIDAL DECK HANGER WITH FIXED NUT

- Requires separate cross bolt and nut
- Use TDHP perforation tool to punch hole in decking

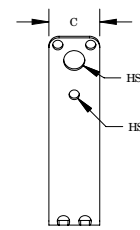
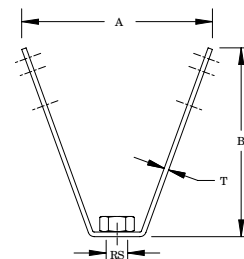

Material: Steel
Finish: Electrogalvanized

Part Number	Article Number	Rod Size	A	B	C	Thickness	Hole Size 1	Hole Size 2	Certifications
TBHKM8	597582	M8	97 mm	91.5 mm	25 mm	2.5 mm	10.5 mm	5 mm	ITB, VdS
TBHKM10	597583	M10	97 mm	91.5 mm	25 mm	2.5 mm	10.5 mm	5 mm	FM, ITB, VdS

Structural Attachments

DECK

EER TRAPEZOIDAL DECK HANGER

- Supports wire from decking

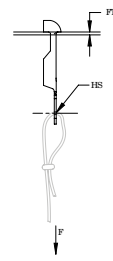

Material: Spring Steel
Finish: nVent CADDY Armour

Part Number	Article Number	Flange Thickness	Hole Size	Drill Bit Diameter	Static Load 1	Static Load 2	Certifications	Standard Packaging Quantity
EER	171470	0.8 – 3.0 mm	6.8 mm	7 mm	450 N	900 N	ITB	100 pc

Static Load 1 represents 0.8 - 2.0 mm flange thickness. Static Load 2 represents 2.0 - 3.0 mm flange thickness.

EER-TI/T TRAPEZOIDAL DECK THREADED ROD HANGER

- Supports rod from decking
- Thread impression for simple installation

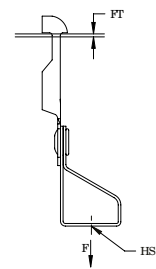

Material: Spring Steel
Finish: nVent CADDY Armour

Part Number	Article Number	Hole Size	Hole Type	Flange Thickness	Drill Bit Diameter	Static Load 1	Static Load 2	Certifications
EERTIM6	173120	M6	Threaded	0.8 – 3.0 mm	7 mm	450 N	900 N	
EERTIM8	173130	M8	Threaded	0.8 – 3.0 mm	7 mm	450 N	900 N	ITB
EERTIM10	173140	M10	Threaded	0.8 – 3.0 mm	7 mm	450 N	900 N	ITB

Static Load 1 represents 0.8 - 2.0 mm flange thickness. Static Load 2 represents 2.0 - 3.0 mm flange thickness.

VKR TRAPEZOIDAL DECK HANGER

- Supports threaded rod

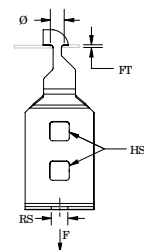

Material: Spring Steel
Finish: nVent CADDY Armour

Part Number	Article Number	Rod Size	Flange Thickness	Hole Size	Diameter	Static Load 1	Static Load 2	Standard Packaging Quantity
M6VKR	160640	M6	0.8 – 3.0 mm	7 mm	7 mm	450 N	600 N	100 pc
M8VKR	160650	M8	0.8 – 3.0 mm	7 mm	7 mm	450 N	900 N	100 pc
M10VKR	160660	M10	0.8 – 3.0 mm	7 mm	7 mm	450 N	900 N	100 pc

Static Load 1 represents 0.8 - 2.0 mm flange thickness. Static Load 2 represents 2.0 - 3.0 mm flange thickness.

Structural Attachments

DECK

OCDC DECK HANGER

- Provide a mobile mounting hole
- Attaches to decking

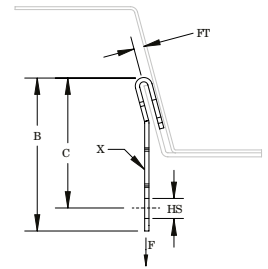

Material: Steel
Finish: nVent CADDY Armour

Part Number	Article Number	Hole Size	Flange Thickness	B	C	X	Static Load
OCDC68MM	160700	6.8 mm	1.0 – 2.5 mm	54 mm	46 mm	13 x 8.5 mm	400 N

OCDC-TI/T DECK THREADED ROD HANGER

- Suspends plain rod, threaded rod and wire drops from decking

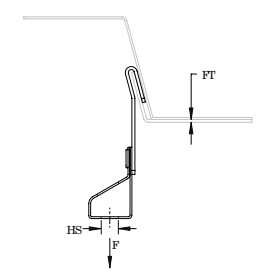

Material: Spring Steel
Finish: nVent CADDY Armour

Part Number	Article Number	Hole Size	Hole Type	Flange Thickness	Static Load
OCDCTIM6	160710	M6	Threaded	1.0 – 2.5 mm	400 N
OCDCTIM8	160720	M8	Threaded	1.0 – 2.5 mm	400 N

GTD DOVETAIL DECK HANGER

- Supports rod from decking

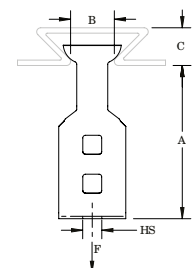

Material: Spring Steel
Finish: nVent CADDY Armour

Part Number	Article Number	Hole Size	Hole Type	A	B	C	Static Load
M10GTD1217	160340	M10	Threaded	55 mm	12 – 17 mm	14 mm Min	900 N
M10GTD1722	160370	M10	Threaded	55 mm	17 – 22 mm	16 mm Min	900 N

Structural Attachments

DECK

HW WEDGE NUT FOR DOVETAIL DECK HANGER

- Trapeze nut for hanging from steel ceilings
- Installs easily
- Fits several composite floor decking profiles

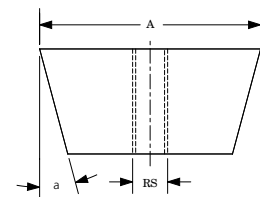
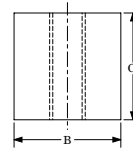
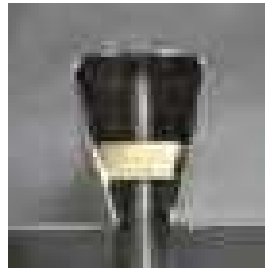

Material: Steel
Finish: Electrogalvanized

Part Number	Article Number	Rod Size	Angle	A	B	C	Static Load
HW6	187270	M6	15°	25 mm	12.0 mm	12.0 mm	1,200 N
HW6M	188740	M6	15°	19 mm	9.5 mm	9.5 mm	1,200 N
HW8	187280	M8	15°	25 mm	12.0 mm	12.0 mm	1,700 N
HW8M	188780	M8	15°	19 mm	9.5 mm	9.5 mm	1,700 N
PHW8	188850	M8	25°	18 mm	9.5 mm	9.5 mm	1,700 N
HW10	187290	M10	15°	25 mm	12.0 mm	12.0 mm	2,100 N
HW10SR	188820	M10	12°	21 mm	13.0 mm	10.0 mm	2,100 N
HW12	187300	M12	15°	25 mm	16.0 mm	16.0 mm	2,100 N

AB-C CEILING TO ROD MOUNTING BRACKET

- Allows rod with pre mounted nuts to be installed from the side
- Allows for vertical height adjustment of up to 40 mm (1.6") for leveling service runs below ceilings

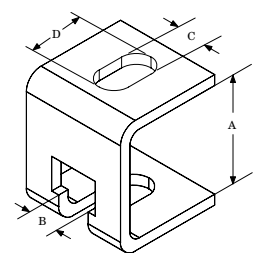

Material: Steel
Finish: Electrogalvanized

Part Number	Article Number	A	B	C	D
ABCM8M10	589300	45 mm	12 mm	10.5 mm	20 mm

Structural Attachments

WALL/CEILING

PBF TWO HOLE BASE PLATE FOR THREADED ROD

- Light duty with two holes and one nut/ adapter

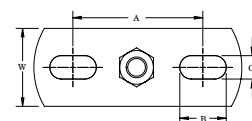
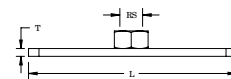

Part Number	Article Number	Rod Size	Length	Width	Thickness	A	B	C
Material: Stainless Steel 316 (EN 1.4401)								
PBRM8M10L70S6	587175	M8, M10	70 mm	33 mm	2 mm	48 mm	10 mm	8 mm
Material: Steel – Finish: ElectroGalvanized								
PBRM10L120	587160	M10	120 mm	40 mm	4 mm	81 mm	18 mm	11 mm
PBRM10L80	587135	M10	80 mm	30 mm	3 mm	50 mm	18 mm	9 mm
PBRM12L120	587165	M12	120 mm	40 mm	4 mm	81 mm	18 mm	11 mm
PBRM8M10L120	587140	M8, M10	120 mm	40 mm	4 mm	81 mm	18 mm	11 mm
PBRM8M10L80	587145	M8, M10	80 mm	30 mm	3 mm	50 mm	18 mm	9 mm

PBF TWO HOLE BASE PLATE FOR THREADED PIPE

- Medium duty with two holes and one nut/ adapter

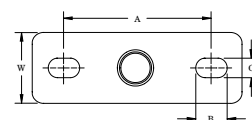
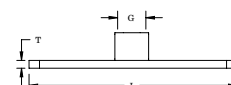

Material: Steel
Finish: ElectroGalvanized

Part Number	Article Number	Gewinde	Length	Width	Thickness	A	B	C
PBT050L120	587120	1/2"	120 mm	40 mm	4 mm	81 mm	18 mm	11 mm
PBT050L80	587125	1/2"	80 mm	30 mm	3 mm	50 mm	18 mm	9 mm

Structural Attachments

WALL/CEILING

TRIANGULAR WALL BRACKET

- Triangular shaped welded bracket manufactured from hot rolled steel

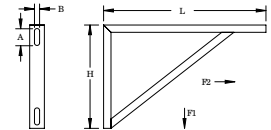
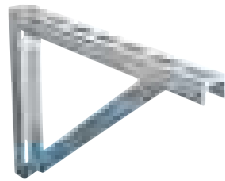

Material: Steel
Finish: Hot-Dip Galvanized

Part Number	Article Number	Height	Length	A	B	Static Load 1	Static Load 2	Certifications
SCT03	312198	350 mm	550 mm	57.5 mm	17.5 mm	4,000 N	8,000 N	ITB

THREAD INSTALL ROD HANGER

- Supports wire or rod from block or concrete walls

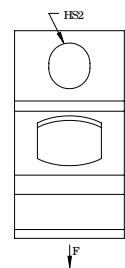
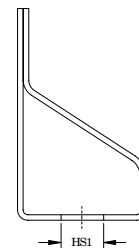

Material: Spring Steel
Finish: nVent CADDY Armour

Part Number	Article Number	Hole Size 1	Hole Type 1	Hole Size 2	Hole Type 2	Static Load
M6TI	174800	M6	Threaded	7 mm	Plain	700 N
M8TI	170900	M8	Threaded	7 mm	Plain	700 N
M10TI	170910	M10	Threaded	7 mm	Plain	700 N

NVENT CADDY ROD LOCK SPRING STEEL ROD HANGER

- Supports rod from block or concrete walls
- Easy “push-to-install” design allows installers to simply push the threaded rod through the mounting hole, instantly holding it in position
- Prefabricated assemblies easily lift and lock into place, helping to save time and money
- Works with slightly damaged threads and minor burrs on threaded rod ends
- Design includes a release mechanism that works with pliers

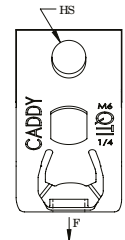
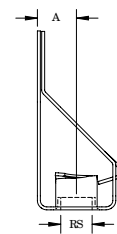

Material: Spring Steel
Finish: nVent CADDY Armour

Part Number	Article Number	Rod Size	Hole Size	A	Static Load
4QT1	174801	M6	7.1 mm	8.4 mm	300 N

Structural Attachments

ROD/WIRE

THREAD INSTALL ROD HANGER WITH ANGLE BRACKET

- Suspends threaded rod from horizontal structures such as laminated wood or concrete beams, joists, ceilings and walls

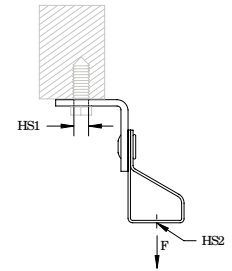

Material: Spring Steel, Steel
Finish: nVent CADDY Armour, Pregalvanized

Part Number	Article Number	Hole Size 1	Hole Type 1	Hole Size 2	Hole Type 2	Static Load
M6TIB	174850	7 mm	Plain	M6	Threaded	700 N
M8TIB	174940	7 mm	Plain	M8	Threaded	700 N
M10TIB	175030	7 mm	Plain	M10	Threaded	700 N

Loads indicated are for nVent CADDY Fasteners only. Method of attachment to structure must be evaluated separately.

NVENT CADDY ROD LOCK SPRING STEEL ROD HANGER WITH NAIL GUN BRACKET

- Suspends threaded rod without the need for additional hardware
- Complete with concrete nail gun insert bracket
- Clips onto nozzle of gas or battery-actuated nail guns allowing for hands-off installation at structure or from the floor using a pole
- Longer leg angle bracket for tool clearance
- Quickly and easily attaches to concrete, steel or composite metal decking
- Easy “push-to-install” design allows installers to simply push the threaded rod through the mounting hole, instantly holding it in position
- Prefabricated assemblies easily lift and lock into place, helping to save time and money
- Works with slightly damaged threads and minor burrs on threaded rod ends
- Design includes a release mechanism that works with pliers

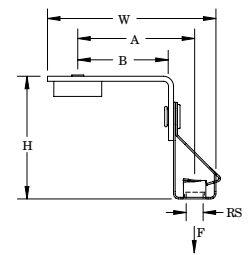
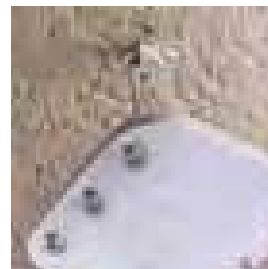

Material: Spring Steel; Steel; Nylon
Finish: nVent CADDY Armour; ElectroGalvanized

Part Number	Article Number	Rod Size	Height H	Width W	A	B	Static Load F
4QTIGBSF	170896	M6	48.7 mm	66.8 mm	46.4 mm	36 mm	300 N

Static Load represents the static load of the nail gun insert assembly. Please consult with the nail manufacturer to evaluate the static load of the nail and type of concrete used for the installation. Maximum load is the lesser of the static load from the nail manufacturer or the published load for the assembly.

Nail gun insert is compatible with BeA® CN60-688ES, Hilti® BX 3, GX 3, DEWALT® Trak-It C3, SPIT® PULSA 800E, 700, 1000 or equivalent nailers.

Structural Attachments

ROD/WIRE

THREAD INSTALL ROD HANGER WITH NAIL GUN BRACKET

- Suspends threaded rod without the need for additional hardware
- Complete with concrete nail gun insert bracket
- Clips onto nozzle of gas or battery-actuated nail guns allowing for hands-off installation at structure or from the floor using a pole
- Longer leg angle bracket for tool clearance
- Quickly and easily attaches to concrete, steel or composite metal decking

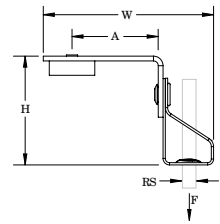

Material: Steel; Nylon
Finish: Electrogalvanized

Part Number	Article Number	Rod Size	Height H	Width W	A	Static Load F
M10TIBGBSF	170916	M10	60 mm	59 mm	38 mm	440 N
M8TIBGBSF	170906	M8	60 mm	59 mm	38 mm	440 N

Static Load represents the static load of the nail gun insert assembly. Please consult with the nail manufacturer to evaluate the static load of the nail and type of concrete used for the installation. Maximum load is the lesser of the static load from the nail manufacturer or the published load for the assembly.

Nail gun insert is compatible with BeA® CN60-688ES, Hilti® BX 3, GX 3, Powers® Trak-It C3, SPIT® PULSA 800E, 700, 1000 or equivalent nailers.

L-BRACKET

- Allows threaded rod or chain drops from walls or structure

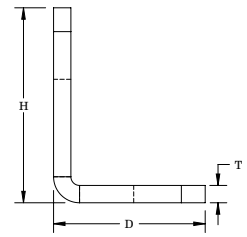
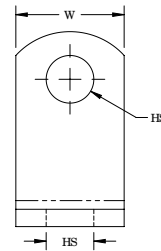

Material: Steel
Finish: Pregalvanized

Part Number	Article Number	Hole Size	Depth	Height	Width	Thickness
AB11MM35X35	387976	11 mm	35 mm	45 mm	25 mm	4 mm

Structural Attachments

ROD/WIRE

ANGLE BRACKET WITH NAIL GUN BRACKET

- Provides an attachment point for nVent CADDY Speed Link assemblies, wire, S-hooks, or chain
- Complete with concrete nail gun insert bracket
- Clips onto nozzle of gas or battery-actuated nail guns allowing for hands-off installation at structure or from the floor using a pole
- Longer leg angle bracket for tool clearance
- Quickly and easily attaches to concrete, steel or composite metal decking

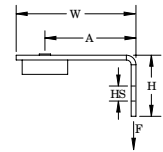

Material: Steel; Nylon
Finish: Electrogalvanized

Part Number	Article Number	Hole Size HS	Height H	Width W	A	Static Load F
ABGBSF	173446	7.1 mm	25.5 mm	50 mm	38 mm	440 N

Static Load represents the static load of the nail gun insert assembly. Please consult with the nail manufacturer to evaluate the static load of the nail and type of concrete used for the installation. Maximum load is the lesser of the static load from the nail manufacturer or the published load for the assembly.

Nail gun insert is compatible with BeA® CN60-688ES, Hilti® BX 3, GX 3, Powers® Trak-It C3, SPIT® PULSA 800E, 700, 1000 or equivalent nailers.

ANGLE BRACKET

- Provides an attachment for nVent CADDY Speed Link assemblies, wire, threaded rod, S-hooks, or chain from concrete or wood

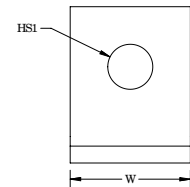
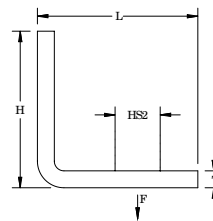

Material: Steel
Finish: Pregalvanized



Part Number	Article Number	Hole Size 1	Hole Size 2	Height	Length	Width	Thickness	Static Load
AB	171120	6.3 mm	6.3 mm	25.3 mm	25.3 mm	19 mm	2.74 mm	700 N

Z-BRACKET

- Allows threaded rod or chain drops from ceilings or structure

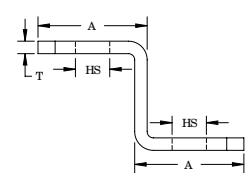
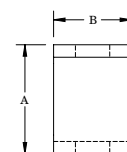

Material: Steel
Finish: Pregalvanized

Part Number	Article Number	Hole Size	A	B	Thickness
ZB11MM35X35	387975	11 mm	35 mm	25 mm	4 mm

Structural Attachments

ROD/WIRE

MULTI-FUNCTION CLIP

- Provides attachment of conduit and boxes
- Supports #10-24 and 1/4-20 threaded bridles rings

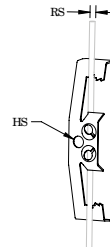
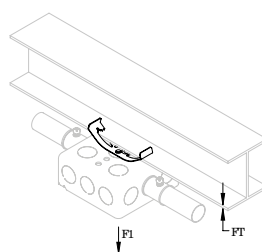
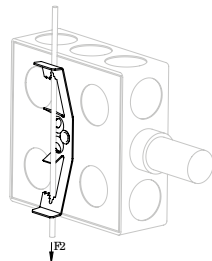
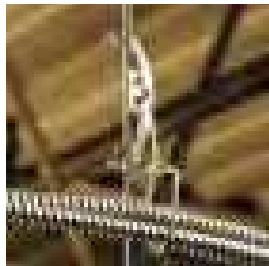

Material: Spring Steel
Finish: nVent CADDY Armour



Part Number	Article Number	Rod Size	Wire Size	Flange Thickness	Hole Size	Screw Included	Static Load 1	Static Load 2	Certifications
4Z34	170650	M4, M6	4.8 mm	3 – 9 mm	6.5 mm	No	110 N	90 N	cULus, ITB
6Z34	170720	M8, M10		9 – 11 mm	6.5 mm	No	110 N	90 N	cULus, ITB

NEC® 300.11 requires dedicated drop wire/rod and EC311.

THREADED STUD

- Pre-cut lengths of threaded rod

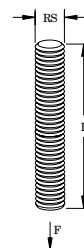
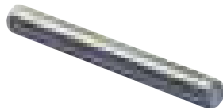

Material: Steel
Finish: Electrogalvanized
Quality Class: 4.6

Part Number	Article Number	Rod Size	Length
051M8025	400336	M8	25 mm
051M8040	400337	M8	40 mm
051M8060	400338	M8	60 mm
051M8070	593465	M8	70 mm
051M8080	400340	M8	80 mm
051M8100	400342	M8	100 mm
051M8120	593476	M8	120 mm
051M8150	593477	M8	150 mm
051M10025	400345	M10	25 mm
051M10040	400346	M10	40 mm
051M10060	400347	M10	60 mm
051M10080	400349	M10	80 mm
051M10090	593505	M10	90 mm
051M10100	400351	M10	100 mm
051M10150	593516	M10	150 mm
051M12040	400355	M12	40 mm

Structural Attachments

FASTENERS/HARDWARE

THREADED ROD

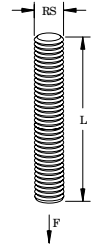
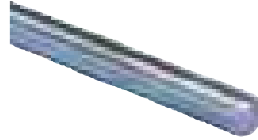

Part Number	Article Number	Rod Size	Length	Static Load
Material: Stainless Steel 304 (EN 1.4301) – Quality Class: 70				
050M61000S4	592700	M6	1,000 mm	2,400 N
050M62000S4	592710	M6	2,000 mm	2,400 N
050M81000S4	592720	M8	1,000 mm	4,500 N
050M82000S4	592730	M8	2,000 mm	4,500 N
050M101000S4	592740	M10	1,000 mm	7,000 N
050M102000S4	592750	M10	2,000 mm	7,000 N
050M121000S4	592760	M12	1,000 mm	10,000 N
Material: Steel – Finish: Electrogalvanized – Quality Class: 4.8				
050M61000	592570	M6	1,000 mm	2,400 N
050M62000	592580	M6	2,000 mm	2,400 N
050M63000	592650	M6	3,000 mm	2,400 N
050M81000	592590	M8	1,000 mm	4,500 N
050M82000	592600	M8	2,000 mm	4,500 N
050M83000	592660	M8	3,000 mm	4,500 N
050M101000	592610	M10	1,000 mm	7,000 N
050M102000	592620	M10	2,000 mm	7,000 N
050M103000	592670	M10	3,000 mm	7,000 N
050M121000	592630	M12	1,000 mm	10,000 N
050M122000	592640	M12	2,000 mm	10,000 N
050M123000	592680	M12	3,000 mm	10,000 N
050M161000	400332	M16	1,000 mm	18,000 N
Material: Steel – Finish: Hot-Dip Galvanized – Quality Class: 4.8				
050M101000HD	592615	M10	1,000 mm	7,000 N
050M121000HD	592635	M12	1,000 mm	10,000 N

THREADED STUD WITH SLOT

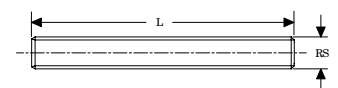
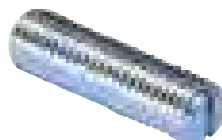

Material: Steel
Finish: Electrogalvanized

Part Number	Article Number	Rod Size	Length
051SM8030	593440	M8	30 mm
051SM8050	593450	M8	50 mm
051SM10050	593490	M10	50 mm

Structural Attachments

FASTENERS/HARDWARE

EXTERNALLY THREADED PIPE

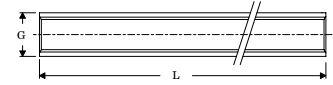
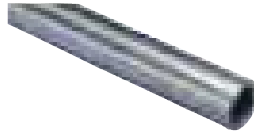

Material: Steel
Finish: Electrogalvanized

Part Number	Article Number	Gewinde	Length
ETP050	583550	1/2"	2,000 mm
ETP100	583570	1"	2,000 mm

INTERNALLY THREADED PIPE

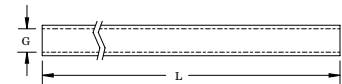
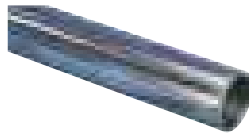

Material: Steel
Finish: Electrogalvanized

Part Number	Article Number	Gewinde	Length
ITP050	588660	1/2"	1,150 mm
ITP075	588670	3/4"	1,150 mm

EM-HEX ROD COUPLER

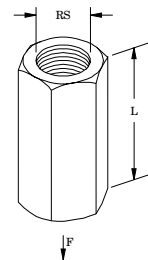
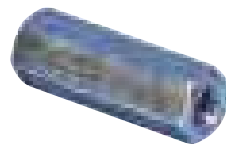

Material: Steel
Finish: Electrogalvanized

Part Number	Article Number	Rod Size	Length	Static Load
025M6EG	592305	M6	30 mm	900 N
025M8EG	592340	M8	30 mm	1,800 N
025M10EG	592350	M10	30 mm	2,800 N
025M12EG	592335	M12	30 mm	4,000 N
025M16EG	592336	M16	30 mm	7,000 N

Structural Attachments

FASTENERS/HARDWARE

EM ROUND ROD CONNECTOR

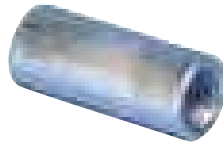

Material: Stainless Steel 304 (EN 1.4301)

Part Number	Article Number	Rod Size	Length
O25DM8S4	401145	M8	30 mm
O25DM10S4	401146	M10	40 mm

PIPE THREAD CONNECTOR

- Connect threaded pipe to PX pipe clamps
- Female-to-female connector

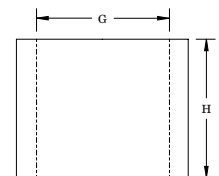

Part Number	Article Number	Gewinde	Height
Material: Stainless Steel 316 (EN 1.4401)			
PTC050S6	578800	1/2"	18 mm
Material: Steel – Finish: Electrogalvanized			
PTC050EG	578730	1/2"	18 mm

RFF ROUND ROD REDUCER

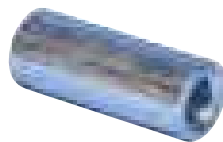

Material: Steel
Finish: Electrogalvanized

Part Number	Article Number	Rod Size 1	Rod Size 2	Length
RFFM8M10	583870	M8	M10	40 mm
RFFM8M12	583880	M8	M12	40 mm
RFFM10M12	583890	M10	M12	40 mm

Structural Attachments

FASTENERS/HARDWARE

RMF HEX MALE-FEMALE REDUCER

- Hexagonal shape

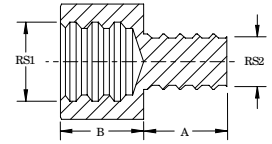
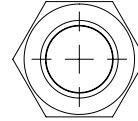

Material: Steel
Finish: Electrogalvanized

Part Number	Article Number	Rod Size 1	Rod Size 2	A	B
RMFM6M8	583710	M6	M8	8 mm	12 mm
RMFM8M6	583720	M8	M6	8 mm	12 mm
RMFM8M10	583730	M8	M10	9 mm	13 mm
RMFM8M12	583740	M8	M12	10 mm	13 mm
RMFM10M8	583750	M10	M8	8 mm	14 mm
RMFM10M12	583760	M10	M12	10 mm	14 mm
RMFM12M8	583770	M12	M8	8 mm	14 mm
RMFM12M10	583780	M12	M10	10 mm	15 mm

RTU BALL SWIVEL

- Swivels up to 15°

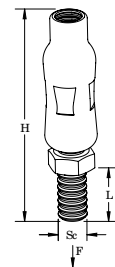
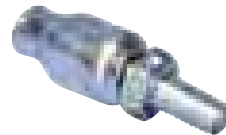

Material: Steel
Finish: Electrogalvanized

Part Number	Article Number	Screw Diameter	Screw Length	Height	Static Load
RTUM8	583580	M8	15 mm	56 mm	2,500 N
RTUM8L15	583600	M8	15 mm	66 mm	2,500 N
RTUM10	583590	M10	18 mm	75 mm	2,500 N
RTUM10L18	583610	M10	18 mm	85 mm	2,500 N
RTUM10L30	583630	M10	30 mm	85 mm	2,500 N
RTUM12L20	583620	M12	20 mm	95 mm	3,000 N

Structural Attachments

FASTENERS/HARDWARE

42 HEX HEAD LAG SCREW

- For use with wood structures

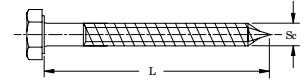

Material: Steel
Finish: Electrogalvanized

Part Number	Article Number	Screw Diameter	Length
042H8065	400405	H8	65 mm

VDF C WOOD-TO-METAL DOWEL SCREW WITH COLLAR

- Wood dowel screw with metric thread connection with collar

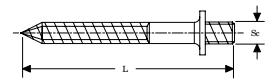
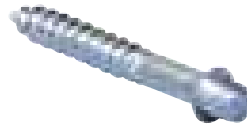

Material: Steel
Finish: Electrogalvanized

Part Number	Article Number	Screw Diameter	Screw Length
VDFCM8040	583850	M8	40 mm

VDF T DRIVE TOOL FOR DOWEL SCREWS

- Tool for screwing in wood thread dowel screws

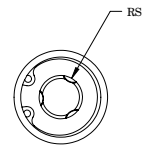
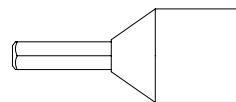

Material: Steel
Finish: Electrogalvanized

Part Number	Article Number	Rod Size
VDFTM8	401121	M8
VDFTM10	401122	M10

Structural Attachments

FASTENERS/HARDWARE

VDF TORX WOOD-TO-METAL SCREW WITH TORX® HEAD

- Wood dowel screw with metric thread connection
- TORX® head

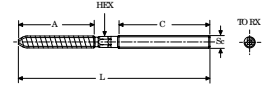

Part Number	Article Number	Screw Diameter	Length	A	C	TORX®
Material: Stainless Steel 304 (EN 1.4301)						
VDFM8050S4	400477	M8	50 mm	28 mm	15 mm	T25
VDFM8080S4	400478	M8	80 mm	40 mm	30 mm	T25
VDFM10100S4	400482	M10	100 mm	55 mm	40 mm	T25
Material: Steel – Finish: Electrogalvanized						
VDFM8050	593270	M8	50 mm	40 mm	10 mm	T25
VDFM8060	593280	M8	60 mm	30 mm	20 mm	T25
VDFM8070	593290	M8	70 mm	30 mm	25 mm	T25
VDFM8080	593300	M8	80 mm	40 mm	30 mm	T25
VDFM8100	593310	M8	100 mm	40 mm	40 mm	T25
VDFM8120	593400	M8	120 mm	50 mm	50 mm	T25
VDFM8150	593410	M8	150 mm	45 mm	50 mm	T25
VDFM8200	593420	M8	200 mm	50 mm	50 mm	T25
VDFM10050	593560	M10	50 mm	30 mm	18 mm	T25
VDFM10060	593330	M10	60 mm	30 mm	18 mm	T25
VDFM10080	593340	M10	80 mm	40 mm	30 mm	T25
VDFM10100	593350	M10	100 mm	60 mm	30 mm	T25
VDFM10120	593370	M10	120 mm	60 mm	50 mm	T25
VDFM10150	593570	M10	150 mm	60 mm	50 mm	T25
VDFM10200	593580	M10	200 mm	60 mm	50 mm	T25
VDFM12120	400403	M12	120 mm	55 mm	30 mm	T30

No HEX when length is 50.0 mm.

HEX HEAD BOLT

- Fully threaded hexagon head bolt

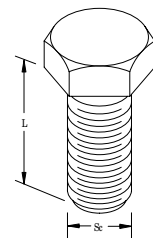
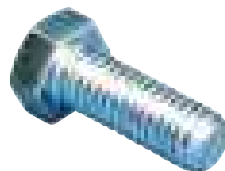

Material: Steel
Complies With: DIN 933

Part Number	Article Number	Screw Diameter	Screw Length
Finish: Electrogalvanized			
HSCRM825EG	593680	M8	25 mm
Finish: Hot-Dip Galvanized			
HSCRM1025HD	593745	M10	25 mm
HSCRM1030HD	593755	M10	30 mm
HSCRM1230HD	593765	M12	30 mm

Structural Attachments

FASTENERS/HARDWARE

SLOTTED HEX HEAD BOLT

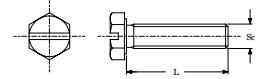
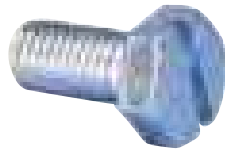

Material: Steel
Finish: Electrogalvanized

Part Number	Article Number	Screw Diameter	Screw Length
THMFM816	592850	M8	16 mm

HEX NUT



Part Number	Article Number	Rod Size
Material: Stainless Steel 304 (EN 1.4301)		
010M8S4	592140	M8
010M10S4	592150	M10
010M12S4	592160	M12
Material: Steel – Finish: Electrogalvanized		
010M6	592040	M6
010M8	592050	M8
010M10	592060	M10
010M12	592070	M12
010M16	400444	M16
Material: Steel – Finish: Hot-Dip Galvanized		
010M10HD	592065	M10
010M12HD	592075	M12

Structural Attachments

FASTENERS/HARDWARE

UNIVERSAL SQUARE NUT

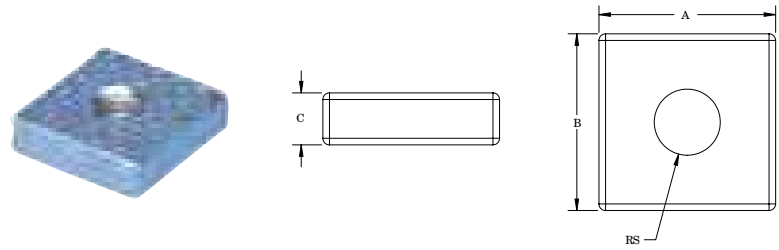

Material: Steel
Finish: Electrogalvanized

Part Number	Article Number	Rod Size	A	B	C
VKM6	187310	M6	17 mm	17 mm	5 mm
VKM8	187320	M8	17 mm	17 mm	5 mm
VKM10	187330	M10	17 mm	17 mm	5 mm

FLAT WASHER



Part Number	Article Number	Hole Size	Diameter	Thickness
Material: Stainless Steel 304 (EN 1.4301)				
01106S4	592480	6.4 mm	12 mm	1.6 mm
01108S4	592490	8.4 mm	16 mm	1.6 mm
01110S4	592500	10.5 mm	20 mm	2.0 mm
01112S4	592510	13.0 mm	24 mm	2.5 mm
Material: Steel – Finish: Electrogalvanized				
01106EG	592390	6.4 mm	12 mm	1.6 mm
01108EG	592400	8.4 mm	16 mm	1.6 mm
01110EG	592410	10.5 mm	20 mm	2.0 mm
01112EG	592420	13.0 mm	24 mm	2.5 mm
01116EG	400448	17.0 mm	30 mm	3.0 mm
Material: Steel – Finish: Hot-Dip Galvanized				
01110HD	592415	10.5 mm	21 mm	2.0 mm
01112HD	592425	13.0 mm	24 mm	2.5 mm

Structural Attachments

FASTENERS/HARDWARE

LARGE WASHER

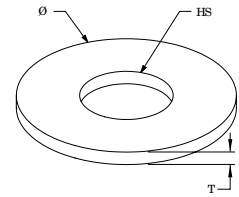

Material: Steel
Finish: Electrogalvanized

Part Number	Article Number	Hole Size	Diameter	Thickness
0120628	585200	6.4 mm	28 mm	2 mm
0120828	584596	8.4 mm	28 mm	2 mm
0120840	584600	8.4 mm	40 mm	3 mm
0121028	584597	10.5 mm	28 mm	2 mm
0121040	584610	10.5 mm	40 mm	3 mm
0121340	584611	13.0 mm	40 mm	3 mm
0121740	584612	17.0 mm	40 mm	3 mm

EB-H WOOD EYE BOLT

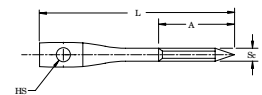

Material: Steel
Finish: Electrogalvanized

Part Number	Article Number	Screw Diameter	Screw Length	A	Hole Size
EYEBH5065EG	574310	H5	65 mm	27 mm	6.5 mm
EYEBH6075EG	574320	H6	75 mm	27 mm	6.5 mm
EYEBH6100EG	574340	H6	100 mm	35 mm	6.5 mm
EYEBH6150EG	574360	H6	150 mm	40 mm	6.5 mm

Structural Attachments

FASTENERS/HARDWARE

ES EYE SOCKET

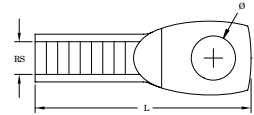
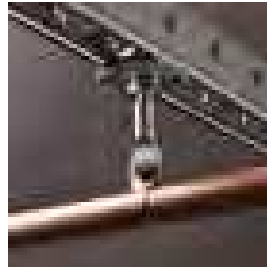

Material: Steel
Finish: Electrogalvanized

Part Number	Article Number	Rod Size	Length	Diameter
EYESM6EG	574250	M6	43 mm	6 mm
EYESM8EG	574260	M8	46 mm	8 mm
EYESM10EG	574270	M10	54 mm	10 mm

LLS-H SLOTTED WOOD EYE BOLT

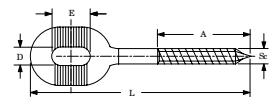

Material: Steel
Finish: Electrogalvanized

Part Number	Article Number	Screw Diameter	Screw Length	A	D	E
LLSH6X30	401129	H6	82 mm	30 mm	7 mm	14 mm

LLS-M SLOTTED EYE BOLT

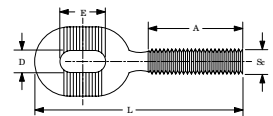

Material: Steel
Finish: Electrogalvanized

Part Number	Article Number	Screw Diameter	Length	A	D	E
LLSM8X30	401126	M8	80 mm	30 mm	9 mm	25 mm

Structural Attachments

FASTENERS/HARDWARE

OSM EYE BOLT

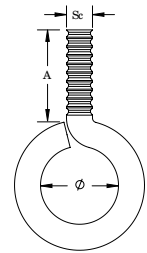

Material: Steel
Finish: Electrogalvanized

Part Number	Article Number	Screw Diameter	Diameter	A
OSM10X30	336060	M10	14 mm	30 mm
OSM8X25	336050	M8	12 mm	25 mm

HIB CONCRETE NAIL WITH COLLAR

- For direct fixing into concrete

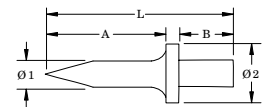

Material: Steel
Finish: Plain

Part Number	Article Number	Length	Diameter 1	Diameter 2	A	B
NAIL04X14	400426	23 mm	4 mm	7.9 mm	14 mm	8 mm
NAIL04X18	400427	27 mm	4 mm	7.9 mm	18 mm	8 mm

HIBT NAIL DRIVE TOOL

- Hammer In tool for HIB nails



Material: Steel, Polyvinylchloride
Finish: Electrogalvanized

Part Number	Article Number
NAILTOOL	400428

Structural Attachments

FASTENERS/HARDWARE

CABLE TIE FASTENER

- Can be attached to various nVent CADDY fasteners or screwed directly to a wall

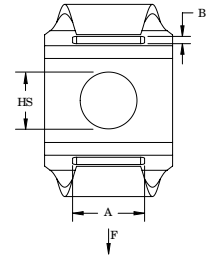

Part Number	Article Number	Hole Size	A	B	Static Load
Material: Spring Steel – Finish: nVent CADDY Armour					
CT	170450	8 mm	9 mm	2 mm	40 N
Material: Stainless Steel 301 (EN 1.4310)					
CTS1	171600	8 mm	9 mm	2 mm	40 N

CABLE TIE, STAINLESS STEEL

- Secures low voltage cables

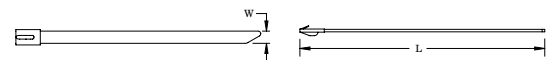
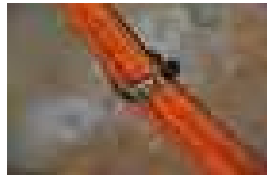

Material: Stainless Steel 316 (EN 1.4401)



Part Number	Article Number	Length	Width
MLT2HS6	188100	200 mm	7.9 mm

Structural Attachments

ANCHORS

BOLT EXPANSION ANCHOR

- Heavy duty wedge anchor
- For cracked and non-cracked concrete

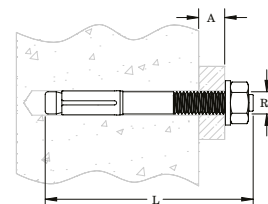

Part Number	Article Number	Rod Size	Length	A	Certifications
Material: Stainless Steel 316 (EN 1.4401)					
SABM8010S6	401150	M8	75 mm	10 mm	CE, BZ-U, VdS
SABM8050S6	401151	M8	115 mm	50 mm	CE, BZ-U, VdS
SABM10010S6	401152	M10	90 mm	10 mm	CE, BZ-U, FM, VdS
SABM10050S6	401153	M10	130 mm	50 mm	CE, BZ-U, FM, VdS
Material: Steel – Finish: Electrogalvanized					
SABM8010	400408	M8	75 mm	10 mm	CE, BZ-U, VdS
SABM8050	400409	M8	115 mm	50 mm	CE, BZ-U, VdS
SABM10010	400410	M10	90 mm	10 mm	CE, BZ-U, FM, VdS
SABM10050	400411	M10	130 mm	50 mm	CE, BZ-U, FM, VdS
SABM12015	402170	M12	110 mm	15 mm	CE, BZ-U, FM, VdS
SABM12050	401158	M12	145 mm	50 mm	CE, BZ-U, FM, VdS
SABM16025	402171	M16	145 mm	25 mm	CE, BZ-U, FM, VdS
SABM20030	402446	M20	167 mm	30 mm	CE, BZ-U, VdS

Extract from Permissible Service Conditions of ETA-99/0010

Approved loads for single anchor without influence of spacing and edge distance

Part Number	Cracked Concrete C20/25	Non-Cracked Concrete C20/25	Standard Embedment Depth
SABM8010	2.4 kN	5.7 kN	46 mm
SABM8050	2.4 kN	5.7 kN	46 mm
SABM10010	4.3 kN	7.6 kN	60 mm
SABM10050	4.3 kN	7.6 kN	60 mm
SABM12015	7.6 kN	11.9 kN	70 mm
SABM12050	7.6 kN	11.9 kN	70 mm
SABM16025	11.9 kN	16.7 kN	85 mm
SABM8010S6	2.4 kN	5.7 kN	46 mm
SABM10010S6	4.3 kN	7.6 kN	60 mm

Total safety factor as per ETAG 001 included (Ym and Yf).

Structural Attachments

ANCHORS

BSZ-SU CONCRETE SCREW

- Fire resistance class R30-R120 for design of anchorages under exposure to fire
- ETA approved for anchoring in cracked and non-cracked concrete
- Approved for use in seismic design category C1 (for Drill Bit Diameters 8mm and greater)
- Removable anchor is ideal for temporary fixings

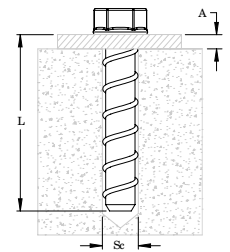

Material: Steel
Finish: Electrogalvanized



Part Number	Article Number	Drill Bit Diameter	Screw Length	Embedment Depth	A	Screw Diameter	Torque	Certifications
BSZSU06040ZL	402605	6 mm	40 mm	35 mm	5 mm	7.5 mm	10 N-m	CE, BSZ-SU, -M, DIBt, VdS
BSZSU06050ZL	402606	6 mm	50 mm	40 mm	10 mm	7.5 mm	10 N-m	CE, BSZ-SU, -M, DIBt, VdS
BSZSU08070ZL	402610	8 mm	70 mm	65 mm	5 mm	10.6 mm	20 N-m	CE, BSZ-SU, M, DIBt, VdS
BSZSU10100ZL	402615	10 mm	100 mm	85 mm	15 mm	12.6 mm	40 N-m	CE, BSZ-SU, M, DIBt, VdS
BSZSU10120ZL	402620	10 mm	120 mm	85 mm	35 mm	12.6 mm	40 N-m	CE, BSZ-SU, M, DIBt, VdS
BSZSU12110ZL	402625	12 mm	110 mm	100 mm	10 mm	14.6 mm	60 N-m	CE, BSZ-SU, M, DIBt, VdS

Extract from Permissible Service Conditions of ETA-16/0204

Approved loads for single anchor without influence of spacing and edge distance

Part Number	Cracked Concrete C20/25	Non-Cracked Concrete C20/25	Standard Embedment Depth
BSZSU06050ZL	1.0 kN	1.9 kN	40 mm
BSZSU08070ZL	5.7 kN	7.6 kN	65 mm
BSZSU10100ZL	9.6 kN	11.9 kN	85 mm
BSZSU10120ZL	9.6 kN	11.9 kN	85 mm
BSZSU12110ZL	12.3 kN	17.2 kN	100 mm

Extract from Permissible Service Conditions of ETA-16/0439

Multiple use for non-structural applications

Part Number	Cracked Concrete C20/25	Non-Cracked Concrete C20/25	Standard Embedment Depth
BSZSU06040ZL	0.6 kN	0.6 kN	35 mm
BSZSU06050ZL	0.6 kN	0.6 kN	35 mm

The maximum load per fixing point for multiple use for non-structural applications may, depending on national regulations, be below the approved load of the anchor. The approved loads per fixing point are regulated for their respective countries in the ETAG 001, Part 6.

Total safety factor as per ETAG 001 included (Y_m and Y_f).

Structural Attachments

ANCHORS

BSZ-M CONCRETE SCREW

- Fire resistance class R30-R120 for design of anchorages under exposure to fire
- ETA approved for anchoring in cracked and non-cracked concrete
- Use in concrete with threaded rod

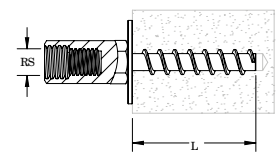
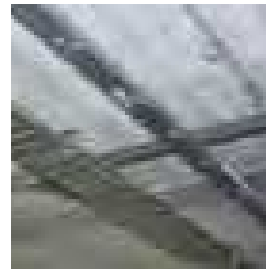

Material: Steel
Finish: Electrogalvanized

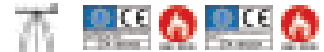

Part Number	Article Number	Screw Length	Rod Size	Drill Bit Diameter	Embedment Depth	Torque	Certifications
BSZM6X35EG	402690	35 mm	M8, M10	6 mm	35 mm	10 N-m	CE, BSZ-SU, -M, DIBt, VdS

Extract from Permissible Service Conditions of ETA-16/0439

Multiple use for non-structural applications

Part Number	Cracked Concrete C20/25	Non-Cracked Concrete C20/25	Standard Embedment Depth
BSZM6X35EG	0.6 kN	0.6 kN	35 mm

The maximum load per fixing point for multiple use for non-structural applications may, depending on national regulations, be below the approved load of the anchor. The approved loads per fixing point are regulated for their respective countries in the ETAG 001, Part 6.

Total safety factor as per ETAG 001 included (Ym and Yf).

SZ-B HIGH LOAD CONCRETE ANCHOR

- Fire resistance class R30-R120 for design of anchorages under exposure to fire
- ETA approved for anchoring in cracked and non-cracked concrete
- Approved for use in seismic design categories C1 and C2

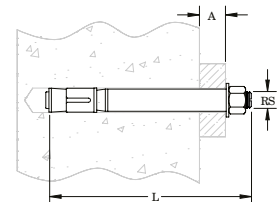
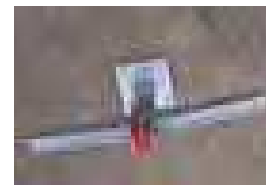
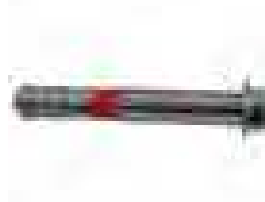

Material: Steel
Finish: Electrogalvanized



Part Number	Article Number	Drill Bit Diameter	Length	Embedment Depth	A	Rod Size	Torque	Certifications
SZB12010EG	402655	12 mm	90 mm	70 mm	10 mm	M8	30 N-m	CE, SZ, DIBt, VdS
SZB12030EG	402660	12 mm	110 mm	70 mm	30 mm	M8	30 N-m	CE, SZ, DIBt, VdS
SZB15015EG	402665	15 mm	111 mm	85 mm	15 mm	M10	50 N-m	CE, SZ, DIBt, VdS
SZB18010EG	402670	18 mm	122 mm	95 mm	10 mm	M12	80 N-m	CE, SZ, DIBt, VdS
SZB18020EG	402675	18 mm	132 mm	95 mm	20 mm	M12	80 N-m	CE, SZ, DIBt, VdS

Extract from Permissible Service Conditions of ETA-02/0030

Approved loads for single anchor without influence of spacing and edge distance

Part Number	Cracked Concrete C20/25	Non-Cracked Concrete C20/25	Standard Embedment Depth
SZB12010EG	2.4 kN	7.6 kN	60 mm
SZB12030EG	5.7 kN	9.5 kN	70 mm
SZB15015EG	7.6 kN	14.3 kN	85 mm
SZB18010EG	11.9 kN	17.1 kN	95 mm
SZB18020EG	11.9 kN	17.1 kN	95 mm

Total safety factor as per ETAG 001 included (Ym and Yf).

Structural Attachments

ANCHORS

THREADED NAIL ANCHOR

- ETA approved for anchoring in cracked and non-cracked concrete
- Fire resistance class R30-R120 for design of anchorages under exposure to fire

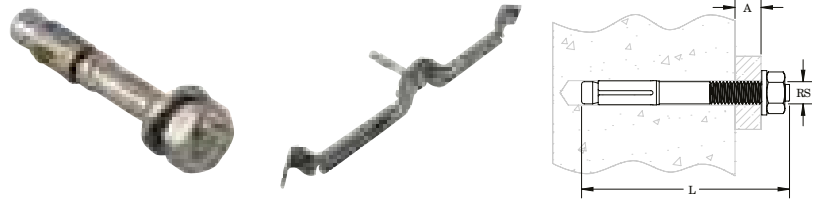

Material: Steel
Finish: Electrogalvanized



Part Number	Article Number	Rod Size	Length	Embedment Depth	A	Drill Bit Diameter
N6T5X10L49	402601	M6	49 mm	35 mm	5 mm	6 mm

Extract from Permissible Service Conditions of ETA-11/0240

Multiple use for non-structural applications

Part Number	Cracked Concrete C20/25	Non-Cracked Concrete C20/25	Standard Embedment Depth
N6T5X10L49	0.6 kN	0.6 kN	30 mm

The maximum load per fixing point for multiple use for non-structural applications may, depending on national regulations, be below the approved load of the anchor. The approved loads per fixing point are regulated for their respective countries in the ETAG 001, Part 6.

Total safety factor as per ETAG 001 included (γ_m and γ_f).

Structural Attachments

ANCHORS

DROP-IN ANCHOR

- Internal thread provides easy removal and serviceability
- Installs flush or below the base surface
- Use setting tool TCA/LA to drive expansion cone to set the anchor

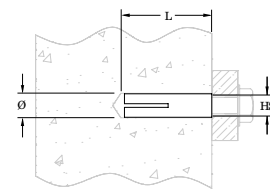
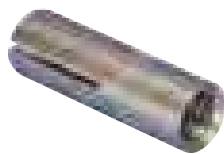

Material: Steel
Finish: Electrogalvanized



Part Number	Article Number	Hole Size	Length	Diameter	Certifications
Material: Stainless Steel 316 (EN 1.4401)					
CAM8030S6	401154	M8	30 mm	10 mm	CE, E/ES, VdS
CAM10040S6	401155	M10	40 mm	12 mm	CE, E/ES, FM, VdS
Material: Steel – Finish: Electrogalvanized					
CAM6030	593180	M6	30 mm	8 mm	CE, E/ES
CAM8030	593190	M8	30 mm	10 mm	CE, E/ES, VdS
CAM8040	593195	M8	40 mm	10 mm	CE, E/ES, VdS
CAM10040	593200	M10	40 mm	12 mm	CE, E/ES, FM, VdS
CAM12050	400415	M12	50 mm	15 mm	CE, E/ES, FM, VdS

Extract from Permissible Service Conditions of ETA-02/0020

Approved loads for single anchor without influence of spacing and edge distance

Part Number	Cracked Concrete C20/25	Non-Cracked Concrete C20/25	Standard Embedment Depth
CAM6030	-	3.3 kN	30 mm
CAM8030	-	3.3 kN	30 mm
CAM8040	-	3.6 kN	40 mm
CAM10040	-	5.1 kN	40 mm
CAM12050	-	7.1 kN	50 mm
CAM16065	-	10.5 kN	65 mm
CAM8030S6	-	3.9 kN	30 mm
CAM10040S6	-	6.1 kN	40 mm

Extract from Permissible Service Conditions of ETA-05/0116

Multiple use for non-structural applications

Part Number	Cracked Concrete C20/25	Non-Cracked Concrete C20/25	Standard Embedment Depth
CAM6030	1.2 kN	1.2 kN	30 mm
CAM8030	1.7 kN	1.7 kN	30 mm
CAM8040	2.0 kN	2.0 kN	40 mm
CAM10040	2.0 kN	2.0 kN	40 mm
CAM12050	2.4 kN	2.4 kN	50 mm
CAM16065	6.3 kN	6.3 kN	65 mm
CAM8030S6	1.7 kN	1.7 kN	30 mm
CAM10040S6	2.0 kN	2.0 kN	40 mm

The maximum load per fixing point for multiple use for non-structural applications may, depending on national regulations, be below the approved load of the anchor. The approved loads per fixing point are regulated for their respective countries in the ETAG 001, Part 6.

Total safety factor as per ETAG 001 included (Ym and Yf).

Structural Attachments

ANCHORS

FLANGED DROP-IN ANCHOR

- Internal thread provides easy removal and serviceability
- Installs flush for standard embedment
- Use setting tool TCA/LA to drive expansion cone to set the anchor

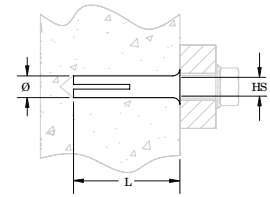
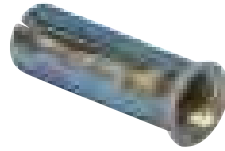

Material: Steel
Finish: Electrogalvanized

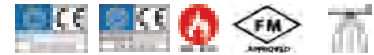

Part Number	Article Number	Hole Size	Length	Diameter	Certifications
LAM625	589890	M6	25 mm	8 mm	CE, E/ES
LAM830	574410	M8	30 mm	10 mm	CE, E/ES, VdS
LAM1040	574420	M10	40 mm	12 mm	CE, E/ES, FM, VdS
LAM1250	574430	M12	50 mm	15 mm	CE, E/ES, FM, VdS

Extract from Permissible Service Conditions of ETA-02/0020

Approved loads for single anchor without influence of spacing and edge distance

Part Number	Cracked Concrete C20/25	Non-Cracked Concrete C20/25	Standard Embedment Depth
LAM830	-	3.3 kN	30 mm
LAM1040	-	5.1 kN	40 mm
LAM1250	-	7.1 kN	50 mm

Extract from Permissible Service Conditions of ETA-05/0116

Multiple use for non-structural applications

Part Number	Cracked Concrete C20/25	Non-Cracked Concrete C20/25	Standard Embedment Depth
LAM625	1.7 kN	1.7 kN	25 mm
LAM830	1.7 kN	1.7 kN	30 mm
LAM1040	2.0 kN	2.0 kN	40 mm
LAM1250	2.4 kN	2.4 kN	50 mm

The maximum load per fixing point for multiple use for non-structural applications may, depending on national regulations, be below the approved load of the anchor. The approved loads per fixing point are regulated for their respective countries in the ETAG 001, Part 6.

Total safety factor as per ETAG 001 included (γ_m and γ_f).

HAMMER-IN TOOL FOR DROP-IN ANCHORS

- Setting tool for CA and LA type drop in anchors

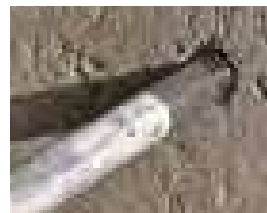
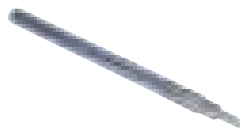

Material: Steel
Finish: Electrogalvanized

Part Number	Article Number	Rod Size	Length
TCAM6025	593145	M6	25 mm
TCAM6030	593150	M6	30 mm
TCAM8030	593160	M8	30 mm
TCAM8040	593165	M8	40 mm
TCAM10040	593170	M10	40 mm
TCAM12050	400420	M12	50 mm
TCAM16065	400421	M16	65 mm

Structural Attachments

ANCHORS

METAL EXPANSION PLUG

- Expansion fixing for wood or drywall / plasterboard screws
- For use in lightweight concrete

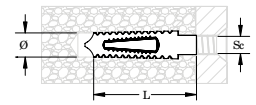
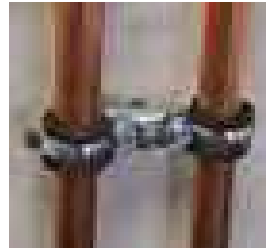
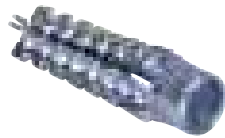

Material: Steel
Finish: Electrogalvanized
Static Load Safety Factor: 5:1

Part Number	Article Number	Screw Diameter	Length	Diameter	Drill Hole Depth	Static Load 1	Static Load 2
CFH838	593210	6 – 8 mm	38 mm	10 – 12 mm	50 mm	350 N	700 N
CFH1060	593220	8 – 10 mm	60 mm	12 – 14 mm	70 mm	950 N	1,200 N

Metal plug with 38 mm (1-1/2") length can be hammered into G2 or G4 low-strength aerated concrete without pre-drilling.

Refer to Static Load 1 when anchoring in G2 low-strength aerated concrete.

Refer to Static Load 2 when anchoring in G4 low-strength aerated concrete.

Static loads are calculated using the maximum Screw Diameter.

BRASS EXPANSION ANCHOR

- Expansion fixing for metric screws
- For use in concrete and brick

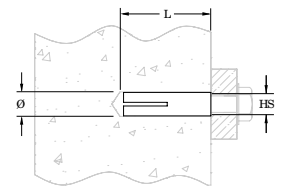
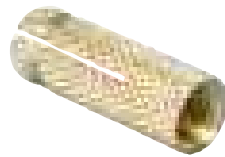

Material: Brass
Static Load Safety Factor: 3.5

Part Number	Article Number	Screw Diameter	Length	Diameter	Static Load 1	Static Load 2
CLM6030	593090	M6	22 mm	8 mm	1,100 N	900 N
CLM8040	593100	M8	30 mm	11 mm	1,600 N	1,300 N
CLM10040	593110	M10	34 mm	13 mm	650 N	550 N

Refer to Static Load 1 when anchoring in non-cracked concrete C20/25.

Refer to Static Load 2 when anchoring in solid brick with a compressive strength greater than 15 MPa.

CAVITY PLUG

- For use in plasterboard
- Ideal for attachment to thin-walled panels
- Large seating area for high loading capacity

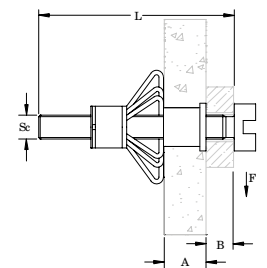

Screw Included: Yes
Material: Steel
Finish: Electrogalvanized

Part Number	Article Number	Screw Diameter	Screw Length	A	B	Ultimate Static Load 1	Ultimate Static Load 2
MFV433	571460	M4	41 mm	3 – 9 mm	12 mm	75 N	115 N
MFV537	571470	M5	45 mm	5 – 13 mm	15 mm	115 N	175 N
MFV650	571510	M6	60 mm	5 – 16 mm	18 mm	155 N	195 N

Refer to Ultimate Static Load 1 when anchor is set in plasterboard.

Refer to Ultimate Static Load 2 when anchor is set in hollow block or hollow cinder block.

Structural Attachments

ANCHORS

SETTING TOOL FOR METAL EXPANSION ANCHOR

- Setting tool for cavity fixing MFP / MFV



Material: Steel
Finish: Painted

Part Number	Article Number	Orientation
MFT1	571520	Top
MFT2	571530	Side

LIGHT DUTY EXPANSION ANCHOR

- Ideal for use with fire rated clips and clamps
- Fire resistance class R30-R120 for design of anchorages under exposure to fire
- ETA approved for anchoring in cracked and non-cracked concrete

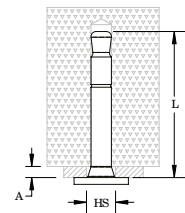
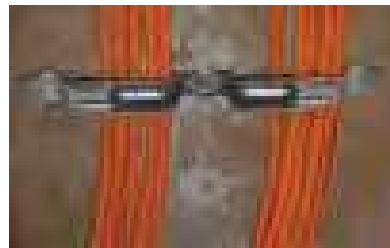

Material: Steel
Finish: Electrogalvanized



Part Number	Article Number	Length	Drill Hole Depth	A	Drill Bit Diameter	Hole Size
SCMND	800071	45 mm	45 mm	5 mm Max	6 mm	7.2 mm

Extract from Permissible Service Conditions of ETA-09/0313

Multiple use for non-structural applications

Part Number	Cracked Concrete C20/25	Non-Cracked Concrete C20/25	Standard Embedment Depth
SCMND	1.4 kN	1.4 kN	45 mm

Drill Hole Depth represents the maximum depth and should be adjusted based on the thickness of product being fixed.

The maximum load per fixing point for multiple use for non-structural applications may, depending on national regulations, be below the approved load of the anchor. The approved loads per fixing point are regulated for their respective countries in the ETAG 001, Part 6.

Total safety factor as per ETAG 001 included (Y_m and Y_f).

Structural Attachments

ANCHORS

LIGHT DUTY PUSH-IN ANCHOR

- Ideal for use with fire rated clips and clamps
- Tool-free push-in installation after hole has been drilled into the concrete
- Fire resistance class R30-R120 for design of anchorages under exposure to fire
- ETA approved for anchoring in cracked and non-cracked concrete

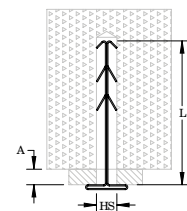

Material: Stainless Steel 301 (EN 1.4310)



Part Number	Article Number	Length	Drill Hole Depth	Hole Size	A
SCMDSN	800070	36 mm	36 mm	6 mm	10 mm Max

Extract from Permissible Service Conditions of ETA-09/0313

Multiple use for non-structural applications

Part Number	Cracked Concrete C20/25	Non-Cracked Concrete C20/25	Standard Embedment Depth
SCMND	1.4 kN	1.4 kN	45 mm

Drill Hole Depth represents the maximum depth and should be adjusted based on the thickness of product being fixed.

The maximum load per fixing point for multiple use for non-structural applications may, depending on national regulations, be below the approved load of the anchor. The approved loads per fixing point are regulated for their respective countries in the ETAG 001, Part 6.

Total safety factor as per ETAG 001 included (Ym and Yf).

NPN HAMMER-IN EXPANSION ANCHOR WITH SCREW

- Secure and time-saving, hammer-in nylon plug with pre-assembled zinc plated nail screw
- Nail plug can be unscrewed for readjustment
- Long splay zone for optimal grip
- Delivered pre-assembled to avoid nail loss

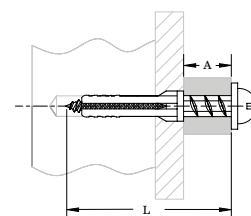
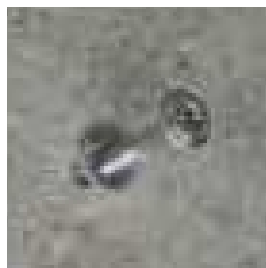
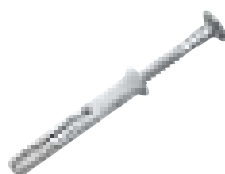

Material: Steel, Nylon
Finish: Electrogalvanized

Part Number	Article Number	Length	A	Drill Bit Diameter
NPN640	570800	40 mm	10 mm	6 mm
NPN660	570810	60 mm	30 mm	6 mm
NPN680	570820	80 mm	40 mm	6 mm
NPN860	570830	60 mm	30 mm	8 mm

Structural Attachments

ANCHORS

FPN UNIVERSAL ANCHOR

- Expansion fixing for wood or drywall / plasterboard screws
- For use in concrete, brick and lightweight concrete



Material: Nylon

Part Number	Article Number	Screw Diameter	Length	Drill Bit Diameter	Drill Hole Depth
FPN10	570730	6.0 – 8.0 mm	50 mm	10 mm	60 mm
FPN12	570740	8.0 – 10.0 mm	60 mm	12 mm	70 mm
FPN6	570710	3.5 – 5.0 mm	30 mm	6 mm	35 mm
FPN8	570720	4.5 – 6.0 mm	40 mm	8 mm	50 mm

PWM/PWN SELF-DRILLING DRYWALL ANCHOR

- Screw in type anchor for plasterboard
- No drilling required

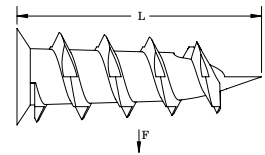

Part Number	Article Number	Length	Screw Included	Ultimate Static Load
Material: Nylon				
PWN	571290	38 mm	Yes	95 N
PWNS	571300	38 mm	No	95 N
Material: Zinc Alloy				
PWM	571270	36 mm	Yes	95 N
PWMS	571280	36 mm	No	95 N

Structural Attachments

ANCHORS

MTSB SPRING TOGGLE WITH NUT/WASHER

- Washer, nut and toggle included
- Used in wall applications

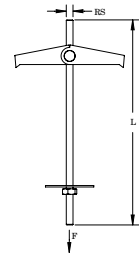
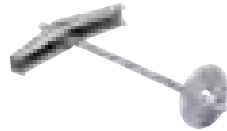

Material: Steel
Finish: Electrogalvanized

Part Number	Article Number	Rod Size	Cavity Depth	Length	Drill Bit Diameter	Ultimate Static Load
MTSB4	584410	M4	35 mm Min	90 mm	14 mm	1,750 N

The Ultimate Static Load value does not take into account the load-bearing characteristics of the supporting material. The appropriate safety factor is to be added to this load rating.

MTSH SPRING TOGGLE WITH HOOK

- Nut and toggle included
- Used in wall applications

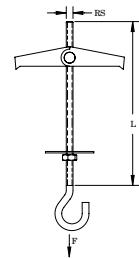

Material: Steel
Finish: Electrogalvanized

Part Number	Article Number	Rod Size	Cavity Depth	Length	Drill Bit Diameter	Ultimate Static Load
MTSH4	584430	M4	35 mm Min	70 mm	14 mm	300 N

The Ultimate Static Load value does not take into account the load-bearing characteristics of the supporting material. The appropriate safety factor is to be added to this load rating.

Structural Attachments

ANCHORS

MTVB GRAVITY TOGGLE WITH RUBBER WASHER

- Complete with rod, nut, washer and load distribution block
- Threaded rod is secured against unintentional removal
- Approved for use in stationary fire protection systems (for pipes up to 2")

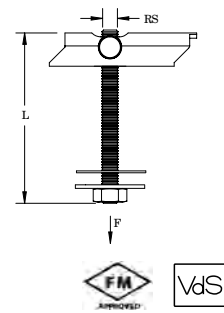

Material: Steel
Finish: Electrogalvanized

Part Number	Article Number	Rod Size	Length	Drill Bit Diameter	Static Load	Ultimate Static Load	Certifications
MTVB10100	584465	M10	100 mm	25 mm	800 N	20 kN	FM, VdS
MTVB10200	584466	M10	200 mm	25 mm	800 N	20 kN	FM, VdS
MTVB8100	584455	M8	100 mm	22 mm	800 N	20 kN	VdS
MTVB8200	584456	M8	200 mm	22 mm	800 N	20 kN	VdS

Static Load represents the maximum recommended load when fixed to a trapezoidal sheet. The Ultimate Static Load value does not take into account the load-bearing characteristics of the supporting material. The appropriate safety factor is to be added to this load rating.

6. nVent CADDY Rod Lock



nVent CADDY Rod Lock

Off-site fabrication (sometimes called modular fabrication) is the process that allows for parts to arrive at a job site preassembled. More and more, contractors are leveraging the efficiencies provided by off-site fabrication, including

- cost savings
- better time management
- safer installations

These benefits apply to a variety of projects, regardless of size or scope.

Historically, complex assemblies were built on-site at the location where they were to be mounted. Installers, therefore, required constant access to the job site in order to keep a project moving according to schedule.

With off-site fabrication, assembly is completed in a space devoted to the production and storage of components. By completing these tasks off-site, contractors can mass-produce assemblies used in similar projects, and on-site installers can focus exclusively on mounting the finished product.

Today, contractors can leverage a range of emerging solutions that allow for new and unique ways to fabricate off-site. While the process may require a new approach to processes such as purchasing, creating and installing assemblies—as well as hardware used during the mounting of a finished piece—off-site fabrication yields countless benefits.

In today's competitive construction market, contractors must provide quality work while lowering labor costs and project time and adhering to safety standards.

The Rod Lock “Push-to-Install” technology allows modular fabrication of complex assemblies off-site or on the ground. Large assemblies can simply then be lifted and locked into place.

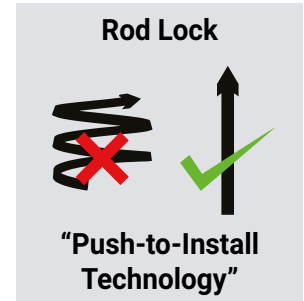

The process requires less time on the job site, allowing for more tasks to be completed in a controlled off-site facility. As a result, off-site fabrication reduces installation costs, enables schedule flexibility and improves safety.

While results may vary based on specific product and application, studies have shown the unique features of the Rod Lock system help reduce the installation time of threaded rod by up to **52 percent** compared to conventional fasteners.

Internal studies have indicated time savings of up to 69% with one person installing a 2-tier trapeze with Rod Lock Strut (compared to traditional installation).

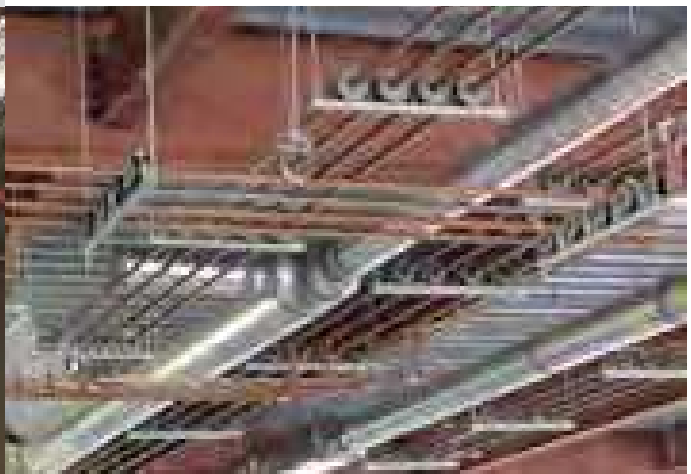
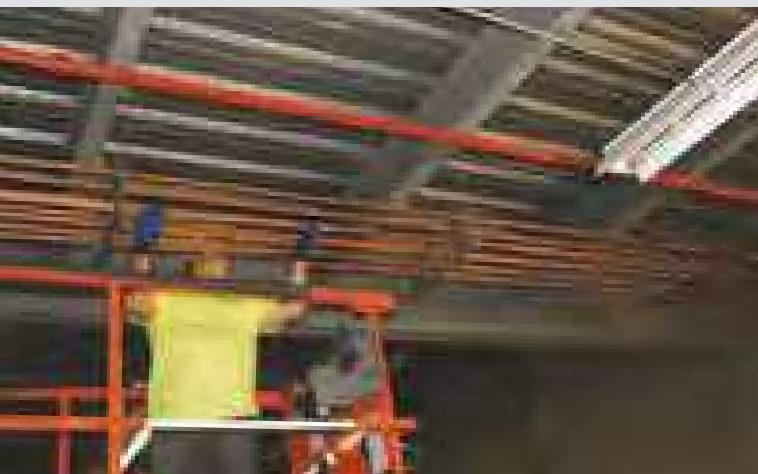
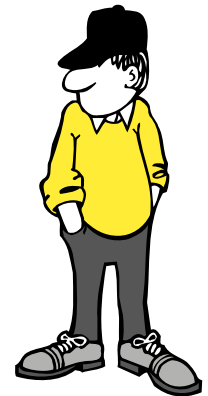

For both contractors and their clients, off-site fabrication offers a host of benefits—chief among these is time savings. In fact, modular fabrication makes schedule compression possible by as much as 18 percent. While this includes the ability to complete a job more quickly, other time related perks should be noted.

More Lead Time

Contractors can plan for projects sooner, and installers can prepare pieces in advance at the off-site shop. They can then quickly install assemblies, requiring less time at the job site.

Less Downtime

Workers can fill gaps in their schedules with projects in the off-site shop. Contractors and installers can rely on more consistent and efficient work schedules.

Schedule Flexibility

To combat restrictions of job site schedules or city ordinances, a majority of prefab work can be completed off-site. Off-site shops can run anytime day or night, allowing for quicker turnaround and enabling the contractor to have greater control over the team's project schedule.

Structure vs. Load

Having the right hardware can make a modular fabrication assembly even more efficient during installation.

Structural attachments are ideal for on-site (partial) off-site fabrication projects, reducing the time spent in the air. Additionally, they are height-adjustable at the structure, but different trapezes can be more difficult to readjust. These attachments are most often used on heavier modules.

Supports are ideal for off-site (full) off-site fabrication projects. They are height-adjustable at the load, and the height for each tier can easily be altered. These are lighter modules, offering easier transportation. Additionally, they allow for prefab using fire-rating structural attachments.

Air Duct Installation

Rectangular duct can be installed two ways using off-site fabrication: attaching directly to the duct or attaching the duct to strut. In both situations, Rod Lock "push-to-install" technology enables easy installation of preassembled pieces.

When attaching directly to the duct, installers should screw Rod Lock Duct Brackets into the side of the duct. Threaded rod should be attached at structure, and the duct assemblies are easily lifted and locked into place.

In strut mounted applications, duct is attached to Rod Lock Strut and the strut is pushed onto the threaded rods.



Pipe Rack Installation

Known Rod Spacing

When installing to a specific rod spacing, the best option is Rod Lock Strut. The pipe runs can be easily lifted and locked into place using Rod Lock “Push-to-Install” technology. It is available for widths of 600-1100mm, and ordered in advance to the desired pre-cut length – eliminating the need for handling long lengths of strut and all the cumbersome activities associated to it.

Unknown Rod Spacing

To install with unknown rod spacing, contractors should use the Rod Lock Telescoping Strut Replacement. The part has Rod Lock hardware at each end of the bar, but can telescope between 318-508mm, and eliminates the need for cutting strut.

Retrofitting

When fabricating off-site retrofit runs of conduit, attach pipe to a TSR1220R. This retrofit version of the Telescoping Strut Replacement can be placed above an existing trapeze and held in place with four nVent CADDY SN Nuts.



The spacing between pipes across the channel needs to be the same so that they meet up with each other when the individual runs are installed. It is recommended that installers use custom wooden jigs with notches at the spacing for each piece. They can be easily made on the jobsite with pieces of wood and customized for individual situations.

The channel is laid next to the jig and the pipe is attached to it. A variety of CADDY fasteners can be used to hold the pipes to the channel. This process is repeated based on the number of runs needed for the total length of pipe on the project.

The threaded rod is attached at structure in advance.



nVent CADDY Rod Lock Threaded Rod Mounting System

NVENT CADDY ROD LOCK STRUCTURAL ATTACHMENTS

NVENT CADDY ROD LOCK BEAM CLAMP

- Prefabricated assemblies easily lift and lock into place, helping to save time and money
- Easy “push-to-install” design allows installers to simply push the threaded rod through the mounting hole, instantly holding it in position
- Lock nut can be finger tightened, locking the rod in place
- Works with slightly damaged threads and minor burrs on the threaded rod
- Conforms with Federal Specification WW-H-171 (Type 23), Manufacturers Standardization Society ANSI/MSS-SP-58 (Type 19 and 23)

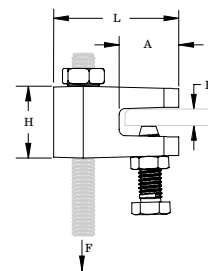
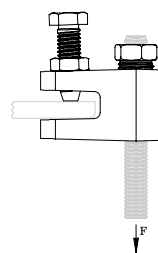
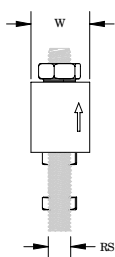
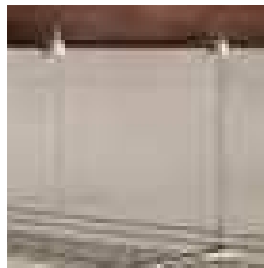

Material: Cast Iron
Finish: Electrogalvanized

Part Number	Article Number	Rod Size	Flange Thickness	Height	Length	Width	A	Static Load 1	Static Load 2	Certifications
CRLBM8EG	390001	M8	3 – 10 mm	30 mm	52.3 mm	25.3 mm	24.9 mm	1,100 N	1,400 N	cULus, ITB, VdS
CRLBM10EG	390002	M10	3 – 10 mm	30 mm	52.3 mm	25.3 mm	24.9 mm	1,100 N	2,200 N	cULus, ITB, VdS

Static Load 1 represents 1/8" to 3/16" (3 mm to 5 mm) flange thickness.
Static Load 2 represents 1/4" to 3/8" (6 mm to 10 mm) flange thickness.

nVent CADDY Rod Lock Threaded Rod Mounting System

NVENT CADDY ROD LOCK STRUCTURAL ATTACHMENTS

NVENT CADDY ROD LOCK ANCHOR SCREW

- For use with concrete and solid brick
- Prefabricated assemblies easily lift and lock into place, helping to save time and money
- Works with slightly damaged threads and minor burrs on the threaded rod

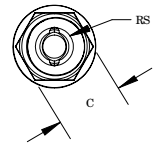
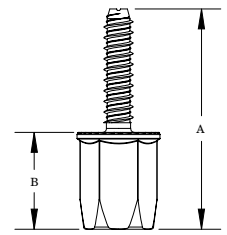

Material: Steel
Finish: Electrogalvanized

Part Number	Article Number	Rod Size	A	B	C	Drill Bit Diameter	Drill Hole Depth	Static Load	Certifications	Standard Packaging Quantity
CRLAM8EG	390009	M8	72 mm	32 mm	22 mm	8 mm	50 mm	2,900 N	ITB	25 pc
CRLAM10EG	390010	M10	72 mm	32 mm	22 mm	8 mm	50 mm	2,900 N	FM, ITB	25 pc

Tested in 3000 psi (20.67 MPa) concrete.

NVENT CADDY ROD LOCK ANCHOR SCREW DRIVE SOCKET

- Drive socket for quick installation of nVent CADDY Rod Lock Anchor Screw



Material: Steel

Part Number	Socket Width
CRLAKITA	22 mm

nVent CADDY Rod Lock Threaded Rod Mounting System

NVENT CADDY ROD LOCK STRUCTURAL ATTACHMENTS

NVENT CADDY ROD LOCK L-BRACKET

- Easy “push-to-install” design allows installers to simply push the threaded rod through the mounting hole, instantly holding it in position
- Prefabricated assemblies easily lift and lock into place, helping to save time and money
- Multiple attachment holes support the use of either self-drilling screws or bolts, offering installation options for concrete, wood, and steel structures
- Lock nut can be finger tightened, locking the rod in place
- Integrated adjustment nut enables fine tuning the system height up or down
- Extremely useful in tight spaces where wrenches are difficult to use
- Conforms with Federal Specification WW-H-171 (Type 23), Manufacturers Standardization Society ANSI®/MSS-SP-58 (Type 19 and 23)

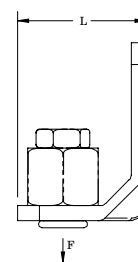
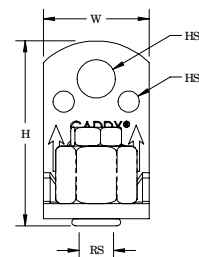

Material: Steel
Finish: Electrogalvanized



Part Number	Article Number	RS	H	L	W	HS1	HS2	Wrench Size	F	Certifications
CRLLM10EG	390012	M10	61.3	43.2	35.6	10.4	7.1	24	3,100	cULus, FM, VdS

Follow fastener manufacturer’s recommended shear and pull-out strength when fastening to the structure. Fastener not included. Install in accordance with applicable code.

nVent CADDY Rod Lock Threaded Rod Mounting System

NVENT CADDY ROD LOCK SUPPORTS

NVENT CADDY ROD LOCK STRUT

- Allows for the quick creation, installation, and adjustment of multi-level trapeze assemblies
- Ready to use out of the box and eliminates the need for cutting and preparing sections of strut
- Easy "push-to-install" design allows installers to simply push the threaded rod through the mounting hole, instantly holding it in position
- Integrated adjustment nut enables fine tuning the system height up or down
- Accommodates slight variances in rod-to-rod position of the trapeze
- No loose parts or special tools needed for installation
- Lock nut can be finger tightened, locking the rod in place
- Works with all accessories that fit standard A or C type strut channels

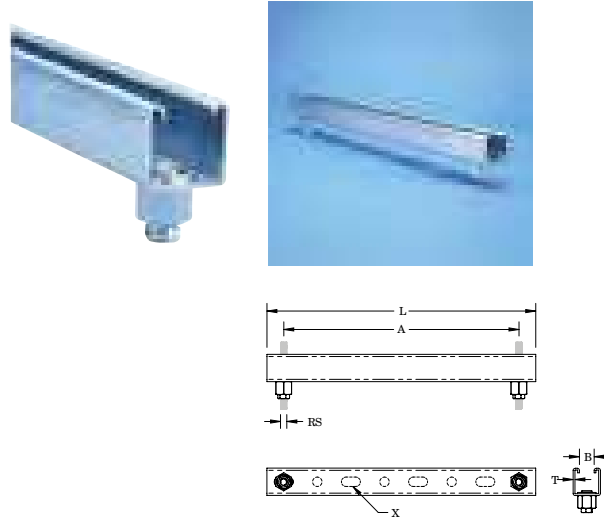

Material: Steel
Finish: Pregalvanized, Electrogalvanized

Part Number	Article Number	Rod Size	Length	Thickness	A	B	X	Ultimate Static Load
Strut Type: A (41 x 41 mm)								
CRLP2M10L550	390037	M10	600 mm	2.5 mm	550 mm	22 mm	14 x 27 mm	7,484 N
CRLP2M10L750	390038	M10	800 mm	2.5 mm	750 mm	22 mm	14 x 27 mm	5,488 N
CRLP2M10L950	390039	M10	1,000 mm	2.5 mm	950 mm	22 mm	14 x 27 mm	4,333 N
CRLP2M10L1050	390040	M10	1,100 mm	2.5 mm	1,050 mm	22 mm	14 x 27 mm	3,920 N
Strut Type: C (21 x 41 mm)								
CRLP1M8L550	390029	M8	600 mm	2.5 mm	550 mm	22 mm	14 x 27 mm	2,306 N
CRLP1M8L750	390030	M8	800 mm	2.5 mm	750 mm	22 mm	14 x 27 mm	1,307 N
CRLP1M10L550	390035	M10	600 mm	2.5 mm	550 mm	22 mm	14 x 27 mm	2,306 N
CRLP1M10L750	390036	M10	800 mm	2.5 mm	750 mm	22 mm	14 x 27 mm	1,307 N

Ultimate load ratings for nVent CADDY Rod Lock Strut assumes a uniformly distributed load and includes a hole factor of 0.92. It is based on the material yield and maximum allowable deflection; an additional Safety Factor of 2 is recommended. nVent CADDY Rod Lock Strut must be installed with the open side of the channel facing up. For indoor applications only.

nVent CADDY Rod Lock Threaded Rod Mounting System

NVENT CADDY ROD LOCK SUPPORTS

NVENT CADDY ROD LOCK TELESCOPING STRUT REPLACEMENT

- Easy “push-to-install” design allows installers to simply push the threaded rod through the mounting hole, instantly holding it in position
- Telescopes to the desired length and is locked in place by snapping closed a spring retainer clip
- Standard strut profile runs the entire length of the part, allowing most standard fittings to be placed anywhere between the rods
- Allows installers to prefabricate complex assemblies and quickly lift and lock them into place
- Lock nut can be finger tightened, locking the rod in place
- Allows for the quick creation, installation, and adjustment of multi-level trapeze assemblies
- Captive threaded nuts enable fastening to threaded rod supports without loose parts
- Integrated ruler displays space between hanger rods in inches and centimeters
- Supports up to seven 2” (50 DN) conduits, six 2” (50 DN) water filled pipes at 10’ (3 m) spacing, or up to 18” (450 mm) cable tray
- Conduit can be supported on the top and bottom, eliminating the need for double sided strut
- Conduit and pipe can be placed directly on the strut profile, saving vertical space in buildings with limited room for installation

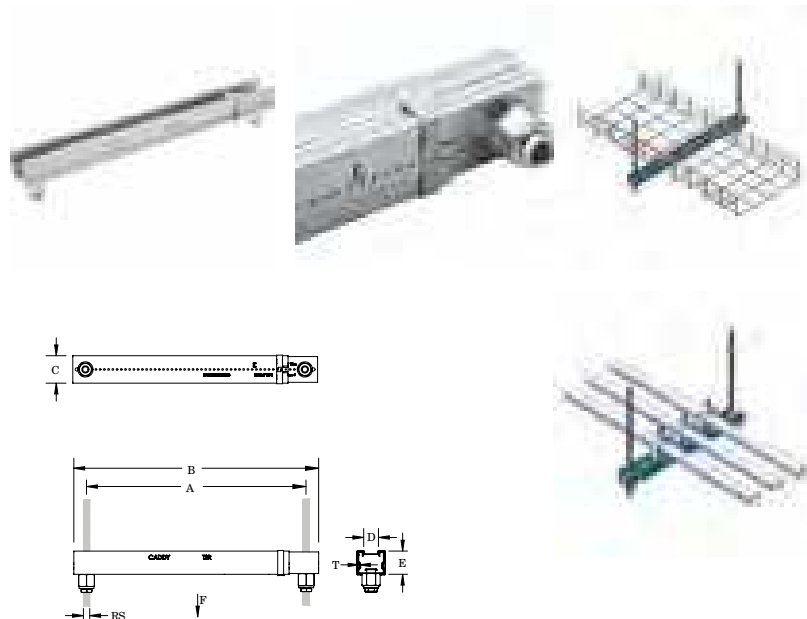

Material: Steel
Finish: Pregalvanized



Part Number	Article Number	Rod Size	Thickness	A	B	C	D	E	Static Load 1	Static Load 2
TSR3050M8RL	390105	M8	1 mm	318 – 508 mm	356 – 546 mm	41 mm	22.2 mm	35 mm	1,330 N	880 N
TSR3050M10RL	390106	M10	1 mm	318 – 508 mm	356 – 546 mm	41 mm	22.2 mm	35 mm	1,330 N	880 N

Static Load 1 represents a distributed load for 12” - 20” (300 - 500 mm) installations and a point load for 12” - 16” (300 - 400 mm) installations. Static Load 2 represents a point load for 16” - 20” (400 - 500 mm) installations.

nVent CADDY Rod Lock Threaded Rod Mounting System

NVENT CADDY ROD LOCK SUPPORTS

NVENT CADDY ROD LOCK CHANNEL NUT

- Provides fast universal attachment of threaded rod and hardware to standard strut profiles
- Can be used to prefabricate assemblies which can be quickly pushed onto previously installed threaded rods
- Works with slightly damaged threads and minor burrs on the threaded rod

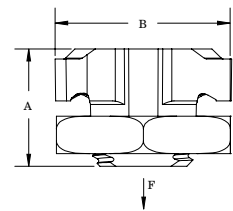
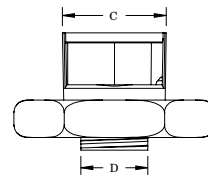
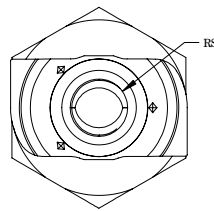
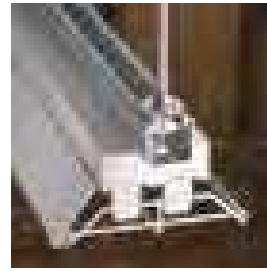

Material: Cast Iron
Finish: Electrogalvanized

Part Number	Article Number	Rod Size	A	B	C	D	Static Load	Certifications	Standard Packaging Quantity
CRLSM8EG	390003	M8	23 mm	35 mm	19.5 mm	13.5 mm	2,750 N	ITB	10 x 10 pc
CRLSM10EG	390004	M10	23 mm	35 mm	19.5 mm	13.5 mm	3,750 N	ITB	10 x 10 pc

SN SERIES NUT

- Allows side mounting of nut to threaded rod
- Reduces the need for threading compared to standard nuts and washers
- Ideal for retrofit projects, such as trapeze installations, where disassembly of the support system is not desired
- Works with slightly damaged threads and minor burrs on the threaded rod
- Reduces installation time up to 50%

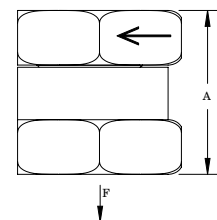
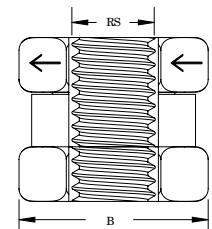
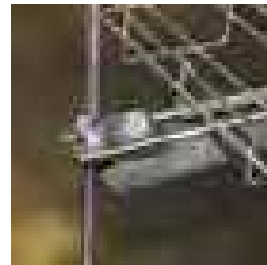

Material: Steel
Finish: Electrogalvanized

Part Number	Article Number	Rod Size	A	B	Static Load	Certifications
SNM6	390005	M6	14 mm	16 mm	1,650 N	ITB
SNM8	390006	M8	19 mm	19 mm	4,500 N	ITB
SNM10	390007	M10	19 mm	19 mm	6,000 N	ITB
SNM12	390008	M12	23 mm	25 mm	10,000 N	ITB

nVent CADDY Rod Lock Threaded Rod Mounting System

NVENT CADDY ROD LOCK HARDWARE

SNSW FLANGED NUT

- Ideal for retrofit projects, such as trapeze installations, where disassembly of the support system is not desired
- Use as a stopper when installing nVent CADDY Rod Lock assemblies
- Can be easily installed, removed, and repositioned at any location along the threaded rod
- Ready to use out of the box and eliminates multiple pieces of standard hardware
- Functions as a hex nut and flat washer combined
- Washer is wide enough to work with standard strut channel profiles

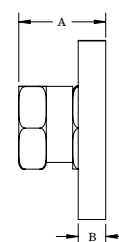
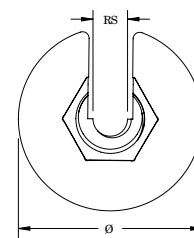
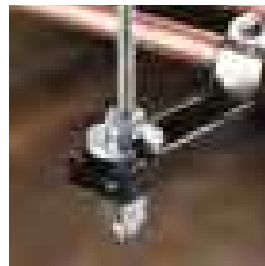

Material: Steel
 Finish: Electrogalvanized
 Static Load Safety Factor: 3:1

Part Number	Article Number	Rod Size	Diameter	A	B	Wrench Size	Static Load
SNSWM8	390101	M8	42.4 mm	20 mm	6.5 mm	19 mm	1,557 N
SNSWM10	390102	M10	42.4 mm	20 mm	6.5 mm	20 mm	1,557 N

For use on plain and electro zinc plated hardware only.



CONNECT AND PROTECT

nVent CADDY Speed Link Catenary System

The nVent CADDY Speed Link Catenary System provides an easy- and fast-to-install fixing solution for commercial buildings where structural supports are far apart. This versatile solution, which can be installed on almost any type of structure, will also increase safety on the jobsite by limiting the amount of time spent on a lift doing repetitive and cumbersome tasks, keeping the number of tools down to a minimum and providing an easy-to-remove solution.

This range supports a wide range of datacom, electrical and mechanical applications, including cable trays, lights, signage and duct.

nVent.com/CADDY



nVent



CADDY

CADDY ERICO HOFFMAN RAYCHEM SCHROFF TRACER

07. nVent CADDY Speed Link



NVENT CADDY SPEED LINK COMES WITH A VARIETY OF LOCKING DEVICES AND END FITTINGS. THE BENEFIT OF THE SYSTEM IS THAT IT IS SO ADAPTABLE, BUT WITH SO MANY OPTIONS OF HOW TO ASSEMBLE THE SYSTEM, IT IS IMPORTANT TO UNDERSTAND THE UNIQUE BENEFITS OF EACH CONFIGURATION.



LOCKING DEVICE AT STRUCTURE

Having the locking device on the structure end of a Speed Link assembly can be beneficial because it allows for the most adaptability with different structure types. When the structure is unpredictable or untraditional, the wire rope only needs to be wrapped around a member and locked in place with an SLK locking device. On the other end, multiple end-fittings can attach to a variety of load types.



LOCKING DEVICE AT LOAD

Having the locking device on the load end of a Speed Link assembly is not required, but is often most beneficial. On the load side, there are more locking device options, including the Speed Link SLS. Additionally, many end fittings are made specifically for different structure types. Regardless of the situation, these fittings, like the concrete anchor and hammer-on beam clamp, cannot be placed on the load side.

With the locking device at the load, fine adjustments are also much easier. If a load needs to be moved slightly up or down, it is much easier to make the adjustment when the installer stands directly next to the service that needs to be moved, as opposed to several meters above at the structure side.



OTHER CONFIGURATIONS

Speed Link can also be purchased in bulk kits with wire rope spools and locking devices. This allows setups with the locking device on each end and infinite loop setup, in which neither end has a locking device. This may be advantageous in installations with unique and non-repeating support needs.

WIRE ROPE —SUPPORT SYSTEMS—

AN EXAMINATION OF THE UNIQUE ADVANTAGES OF WIRE ROPE SUPPORT SYSTEMS IN MECHANICAL, ELECTRICAL AND DATACOM INSTALLATIONS.

Benefits of a Wire Rope Support System



Cable support systems offer a unique combination of advantages that benefit almost any contracting project.

CONTRACTORS USE WIRE ROPE SUPPORT SYSTEMS BECAUSE THEY ARE LIGHTWEIGHT, SAFE, EFFECTIVE AND EASY TO INSTALL. WHILE MOST COMPARABLE METHODS ARE DESIGNED FOR A SPECIFIC APPLICATION, WIRE ROPE SYSTEMS EXCEL IN FOUR KEY AREAS:

ADAPTABILITY: Unlike other support systems, wire rope can be easily adapted to work with a variety of applications. The system appears very simple, but can be easily modified to hang rectangular duct, spiral duct, piping, basket tray, light fixtures and almost any other application that hangs from the ceiling. When cable supports are used for multiple applications on a jobsite, it greatly reduces the number of different products and tools that are needed, reduces waste, and simplifies purchasing.

FLEXIBILITY: Steel cable is incredibly flexible and allows for assemblies to be supported from a variety of angles. Unlike other methods that can be rigid and demand timely measurement, wire rope gives installers more slack when installing.

SPEED: Traditional support methods can make installing large assemblies very difficult. However, wire rope systems can be very quickly installed. Other hanging methods like jack chain, metal strap and threaded rod, need to be measured, cut, and installed using several tools. Wire rope systems are much easier to adjust and eliminate many of the time consuming tasks required for other installation methods.

ADJUSTABILITY: Installers can easily make fine adjustments with a wire rope support system by unlocking the wire from the locking device, moving the assembly and relocking the wire. Additionally, even load distribution between several supports can be easily and quickly checked by measuring cable tension the same way a contractor would measure tension on a V-Belt.

nVent CADDY Speed Link Universal Support System

NVENT CADDY SPEED LINK CATENARY SYSTEM

NVENT CADDY SPEED LINK CATENARY KIT

- Kit includes precut length of fuse-cut cable to avoid fraying, pre-assembled hook end fitting and tool-free locking device to save installation time
- Fastens to the building structure by looping around and hooking to wire rope
- Hook end-fitting easily attaches to eye nut
- Spring latch helps provide secure connection

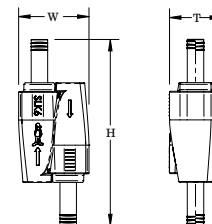
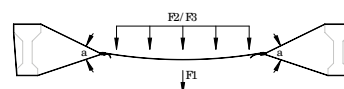
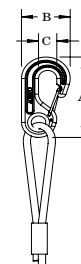

Material: Steel, Zinc Alloy, Polypropylene
 Finish: Electrogalvanized, Hot-Dip Galvanized
 Wire Rope Diameter: 6 mm

Part Number	Article Number	Wire Rope Length	A	B	C	Height	Width	Thickness	Angle
SLK6L5	196800	5 m	75 mm	40 mm	15 mm	108 mm	41 mm	30 mm	60° Max
SLK6L10	196801	10 m	75 mm	40 mm	15 mm	108 mm	41 mm	30 mm	60° Max
SLK6L15	196802	15 m	75 mm	40 mm	15 mm	108 mm	41 mm	30 mm	60° Max
SLK6L20	196803	20 m	75 mm	40 mm	15 mm	108 mm	41 mm	30 mm	60° Max
SLK6L25	196804	25 m	75 mm	40 mm	15 mm	108 mm	41 mm	30 mm	60° Max
SLK6L30	196805	30 m	75 mm	40 mm	15 mm	108 mm	41 mm	30 mm	60° Max
SLK6L40	196806	40 m	75 mm	40 mm	15 mm	108 mm	41 mm	30 mm	60° Max
SLK6L50	196807	50 m	75 mm	40 mm	15 mm	108 mm	41 mm	30 mm	60° Max

Static Load 1	Static Load 2	Static Load 3	Static Load 4
590 N	1,080 N	1,180 N	4,440 N

Wire Rope Length is measured from the end of the wire rope to the hook side of the swage. Static load 1 represents a point load in the center of the catenary installation. Static load 2 represents a two or three point distributed load on the catenary installation. Static load 3 represents a four or more point distributed load on the catenary installation.

nVent CADDY Speed Link Universal Support System

NVENT CADDY SPEED LINK CATENARY SYSTEM

NVENT CADDY SPEED LINK CATENARY CABLE SPOOL

- Used for installing custom lengths of catenary cable with two locking devices
- Spool with nVent CADDY Speed Link steel wire
- Wire rope constructed from 7 bundles of 19 strands each of steel aircraft wire

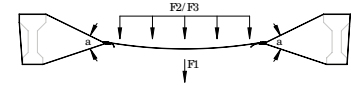
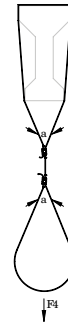

Material: Steel
Finish: Hot-Dip Galvanized

Part Number	Article Number	Wire Rope Diameter	Wire Rope Length	Angle	Static Load 1	Static Load 2	Static Load 3	Static Load 4
SLC6CT0	196819	6 mm	–	60° Max	590 N	1,080 N	1,180 N	4,440 N
SLC6L50	196821	6 mm	50 m	60° Max	590 N	1,080 N	1,180 N	4,440 N

Static load 1 represents a point load in the center of the catenary installation. Static load 2 represents a two or three point distributed load on the catenary installation. Static load 3 represents a four or more point distributed load on the catenary installation.

NVENT CADDY SPEED LINK CATENARY LOCKING DEVICE

- Push/pull keyless release allows easy adjustments
- Low-profile locking device minimizes visual impact
- Cable spread of 60 degrees allows positioning the device closer to the structure
- Keyless release tubes are easy to operate while wearing gloves

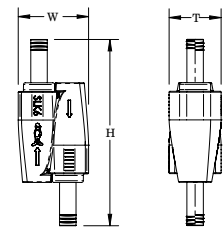

Material: Steel, Polypropylene, Zinc Alloy

Part Number	Article Number	Wire Rope Diameter	Height	Width	Thickness
SLK6C2	196820	6 mm	108 mm	41 mm	30 mm

Locking devices are only to be used with nVent CADDY Speed Link wire spools and accessories with the same specified Wire Rope Diameter as the locking device. Do not use with any other wires.

DROP WIRE CLIP

- Can be used to hang services from catenary cable or act as an intermediate support to reduce sag and tension
- Easily snaps onto catenary cable and locks in place when closed
- Tool-free clip can be hand-closed on the catenary wire

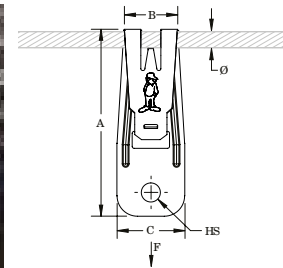
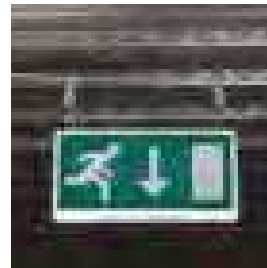

Material: Spring Steel
Finish: nVent CADDY Armour

Part Number	Article Number	Hole Size	A	B	C	Diameter	Static Load
SLDW6	196822	7 mm	70 mm	20 mm	25 mm	6 mm	700 N

nVent CADDY Speed Link Universal Support System

NVENT CADDY SPEED LINK CATENARY SYSTEM

NVENT CADDY SPEED LINK SLK WITH DROP WIRE CLIP

- Complete system includes wire, locking device and pre-assembled drop wire clip end fitting for catenary cable
- Can be used to hang services from catenary cable or act as an intermediate support to reduce sag and tension
- Easily snaps onto catenary cable and locks in place when closed
- Tool-free clip can be hand-closed on the catenary wire

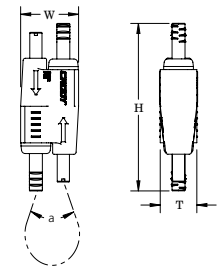
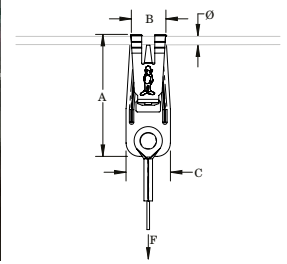

Material: Steel, Spring Steel, Polypropylene
 Finish: Electrogalvanized, nVent CADDY Armour
 Static Load Safety Factor: 5:1

Part Number	Article Number	Wire Rope Length	A	B	C	Diameter	Height	Width	Thickness	Angle
Wire Rope Diameter: 1.5 mm										
SLK15L1DW6	196830	1 m	70 mm	20 mm	25 mm	6 mm	55 mm	19 mm	12.5 mm	90° Max
SLK15L2DW6	196831	2 m	70 mm	20 mm	25 mm	6 mm	55 mm	19 mm	12.5 mm	90° Max
SLK15L3DW6	196832	3 m	70 mm	20 mm	25 mm	6 mm	55 mm	19 mm	12.5 mm	90° Max
SLK15L5DW6	196833	5 m	70 mm	20 mm	25 mm	6 mm	55 mm	19 mm	12.5 mm	90° Max
SLK15L7DW6	196834	7 m	70 mm	20 mm	25 mm	6 mm	55 mm	19 mm	12.5 mm	90° Max
SLK15L10DW6	196835	10 m	70 mm	20 mm	25 mm	6 mm	55 mm	19 mm	12.5 mm	90° Max
Wire Rope Diameter: 2.0 mm										
SLK2L1DW6	196836	1 m	70 mm	20 mm	25 mm	6 mm	55 mm	19 mm	12.5 mm	90° Max
SLK2L2DW6	196837	2 m	70 mm	20 mm	25 mm	6 mm	55 mm	19 mm	12.5 mm	90° Max
SLK2L3DW6	196838	3 m	70 mm	20 mm	25 mm	6 mm	55 mm	19 mm	12.5 mm	90° Max
SLK2L5DW6	196839	5 m	70 mm	20 mm	25 mm	6 mm	55 mm	19 mm	12.5 mm	90° Max
SLK2L7DW6	196840	7 m	70 mm	20 mm	25 mm	6 mm	55 mm	19 mm	12.5 mm	90° Max
SLK2L10DW6	196841	10 m	70 mm	20 mm	25 mm	6 mm	55 mm	19 mm	12.5 mm	90° Max
Wire Rope Diameter: 3.0 mm										
SLK3L1DW6	196842	1 m	70 mm	20 mm	25 mm	6 mm	62 mm	24 mm	16.0 mm	90° Max
SLK3L2DW6	196843	2 m	70 mm	20 mm	25 mm	6 mm	62 mm	24 mm	16.0 mm	90° Max
SLK3L3DW6	196844	3 m	70 mm	20 mm	25 mm	6 mm	62 mm	24 mm	16.0 mm	90° Max
SLK3L5DW6	196845	5 m	70 mm	20 mm	25 mm	6 mm	62 mm	24 mm	16.0 mm	90° Max
SLK3L7DW6	196846	7 m	70 mm	20 mm	25 mm	6 mm	62 mm	24 mm	16.0 mm	90° Max
SLK3L10DW6	196847	10 m	70 mm	20 mm	25 mm	6 mm	62 mm	24 mm	16.0 mm	90° Max

nVent CADDY Speed Link Universal Support System

NVENT CADDY SPEED LINK CATENARY SYSTEM

EYE NUT

- Use with anchors to install catenary system directly to concrete

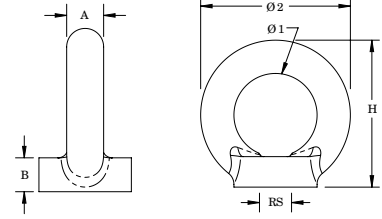

Material: Steel
Finish: Hot-Dip Galvanized

Part Number	Rod Size	Diameter 1	Diameter 2	Height	A	B
196855	M12	30 mm	54 mm	53 mm	12 mm	12 mm

BEAM ATTACHMENT KIT

- For installations where the cable cannot be looped around the steel beam
- Can support two catenary systems using each eye nut as an anchoring point
- Kit includes beam clamps and eye nuts
- Installs on top or bottom flange of I-beams

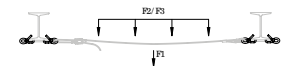
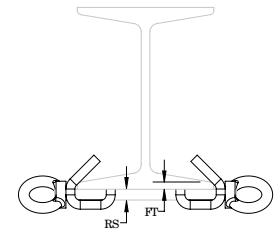

Material: Steel
Finish: Electrogalvanized, Hot-Dip Galvanized

Part Number	Article Number	Flange Thickness	Rod Size	Static Load 1	Static Load 2	Static Load 3
SLBM12	196852	10 – 20 mm	M12	390 N	690 N	780 N

Static load 1 represents a point load in the center of the catenary installation. Static load 2 represents a two or three point distributed load on the catenary installation. Static load 3 represents a four or more point distributed load on the catenary installation.

CATENARY TENSIONING TOOL

- Self-supporting tool allows one-handed tensioning
- Accurate measurement of the cable tension
- Used to install and remove catenary system
- Torque wrench can be easily removed for calibration
- Highly durable

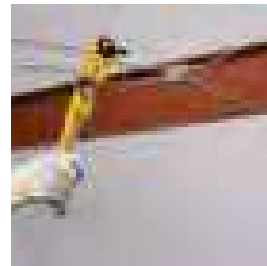

Part Number	Article Number
SL6T	196850

nVent CADDY Speed Link Universal Support System

NVENT CADDY SPEED LINK SLK SYSTEM

NVENT CADDY SPEED LINK SLK WITH ANGLE BRACKET

- Complete system includes wire, locking device and pre-assembled angle bracket end fitting
- Ideal for attaching to concrete, steel or wood surfaces
- Simple alternative to jack chain and additional hardware

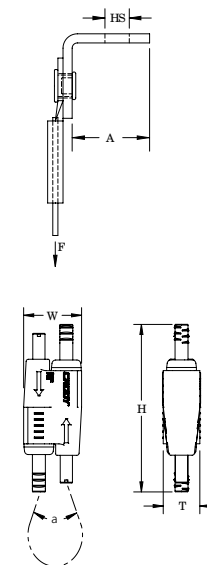
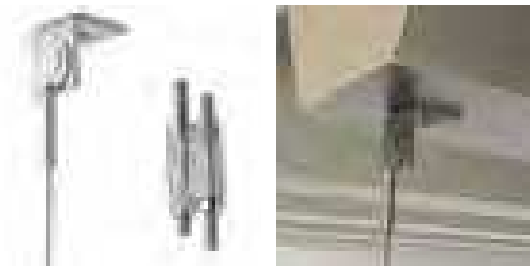

Material: Steel, Zinc Alloy, Polypropylene
 Finish: Electrogalvanized
 Static Load Safety Factor: 5:1
 Complies With: SMACNA HVAC-DCS



Part Number	Article Number	Wire Rope Length	A	Hole Size	Height	Width	Thickness	Angle	Static Load	Certifications
Wire Rope Diameter: 1.5 mm										
SLK15L1AB	196500	1 m	22.6 mm	7.1 mm	55 mm	19 mm	12.5 mm	90° Max	195 N	cULus, ITB
SLK15L2AB	196501	2 m	22.6 mm	7.1 mm	55 mm	19 mm	12.5 mm	90° Max	195 N	cULus, ITB
SLK15L3AB	196502	3 m	22.6 mm	7.1 mm	55 mm	19 mm	12.5 mm	90° Max	195 N	cULus, ITB
SLK15L5AB	196503	5 m	22.6 mm	7.1 mm	55 mm	19 mm	12.5 mm	90° Max	195 N	cULus, ITB
Wire Rope Diameter: 2.0 mm										
SLK2L2AB	196529	2 m	22.6 mm	7.1 mm	55 mm	19 mm	12.5 mm	90° Max	440 N	cULus, ITB
SLK2L3AB	196530	3 m	22.6 mm	7.1 mm	55 mm	19 mm	12.5 mm	90° Max	440 N	cULus, ITB
SLK2L5AB	196531	5 m	22.6 mm	7.1 mm	55 mm	19 mm	12.5 mm	90° Max	440 N	cULus, ITB
Wire Rope Diameter: 3.0 mm										
SLK3L2AB	196713	2 m	22.6 mm	7.1 mm	62 mm	24 mm	16.0 mm	90° Max	890 N	
SLK3L5AB	196715	5 m	22.6 mm	7.1 mm	62 mm	24 mm	16.0 mm	90° Max	890 N	
SLK3L7AB	196728	7 m	22.6 mm	7.1 mm	62 mm	24 mm	16.0 mm	90° Max	890 N	
SLK3L10AB	196716	10 m	22.6 mm	7.1 mm	62 mm	24 mm	16.0 mm	90° Max	890 N	

nVent CADDY Speed Link Universal Support System

NVENT CADDY SPEED LINK SLK SYSTEM

NVENT CADDY SPEED LINK SLK WITH SHOT-FIRE BRACKET

- Complete system includes wire, locking device and shot-fire bracket with pre-assembled drive pin from Powers Fasteners, Inc.
- Quickly and easily attaches to concrete, steel or composite metal decking
- Integrated pin installs easily using powder-actuated or single-shot gas-actuated tools
- ICC-ES ESR-2024 evaluation report available for drive pin from Powers Fasteners, Inc

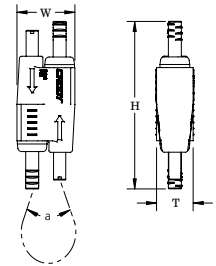
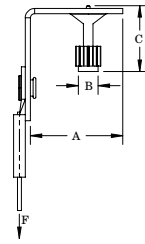

Material: Steel, Zinc Alloy, Polypropylene
 Finish: Electrogalvanized
 Static Load Safety Factor: 5:1
 Complies With: SMACNA HVAC-DCS



Part Number	Article Number	Wire Rope Length	A	B	C	Static Load
Wire Rope Diameter: 1.5 mm						
SLK15L1SF	196517	1 m	37.5 mm	7.6 mm	31.8 mm	195 N
SLK15L2SF	196518	2 m	37.5 mm	7.6 mm	31.8 mm	195 N
SLK15L3SF	196519	3 m	37.5 mm	7.6 mm	31.8 mm	195 N
SLK15L5SF	196520	5 m	37.5 mm	7.6 mm	31.8 mm	195 N
Wire Rope Diameter: 2.0 mm						
SLK2L2SF	196546	2 m	37.5 mm	7.6 mm	31.8 mm	440 N
SLK2L3SF	196547	3 m	37.5 mm	7.6 mm	31.8 mm	440 N
SLK2L5SF	196548	5 m	37.5 mm	7.6 mm	31.8 mm	440 N
Height	Width	Thickness	Angle			
55 mm	19 mm	12.5 mm	90° Max			

Uses Powers Fasteners, Inc. part number 50032. Static load was established based on a 1" (25.4 mm) embedment depth and 3,000 psi (20.68 MPa) lightweight concrete. For variations in embedment and material please consult www.powers.com. Pre-assembled drive pin from Powers Fasteners, Inc. works with Powers® C4CZ, Simpson® GCN-MEPKT, SPIT® P1000, P200, P2201, P3500 / PA3500, P35s, P45, P60, P7201, Sniper; Ramset® 721, Cobra, D45 / D60 / D60L, M70, SA270, T3SS, TS750P, TS60P; Viper; Hilti® DX35, DX350 / DX351 / DX36M, DX100 / DX200, DX460, DXA40, DXA41, DXE72 / DX400; Würth Diva-1, BST-1, BST-2 or equivalent nailers. For shot-fired supports in seismic design category D, E, or F, maximum load is the lesser of 90 lb (400 N) or the published load.

nVent CADDY Speed Link Universal Support System

NVENT CADDY SPEED LINK SLK SYSTEM

NVENT CADDY SPEED LINK SLK WITH NAIL GUN BRACKET

- Complete system includes wire, locking device and shot-fire bracket with pre-assembled drive pin from Powers Fasteners, Inc.
- Quickly and easily attaches to concrete, steel or composite metal decking
- Integrated pin installs easily using powder-actuated or single-shot gas-actuated tools
- ICC-ES ESR-2024 evaluation report available for drive pin from Powers Fasteners, Inc

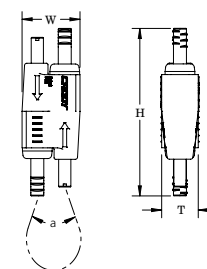
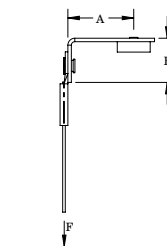

Material: Steel; Zinc Alloy; Polypropylene; Nylon
 Finish: Electrogalvanized
 Static Load Safety Factor: 5:1

Part Number	Article Number	Wire Rope Length	A	B	Static Load
Wire Rope Diameter: 1.5 mm					
SLK15L2GBSF	197812	2 m	38 mm	25.5 mm	195 N
SLK15L3GBSF	197813	3 m	38 mm	25.5 mm	195 N
Wire Rope Diameter: 2.0 mm					
SLK2L2GBSF	197814	2 m	38 mm	25.5 mm	440 N
SLK2L3GBSF	197815	3 m	38 mm	25.5 mm	440 N
Height	Width	Thickness	Angle		
55 mm	19 mm	12.5 mm	90° Max		

Static Load represents the static load of the nail gun insert assembly. Please consult with the nail manufacturer to evaluate the static load of the nail and type of concrete used for the installation. Maximum load is the lesser of the static load from the nail manufacturer or the published load for the assembly.

Nail gun insert is compatible with BeA® CN60-688ES, Hilti® BX 3, GX 3, Powers® Trak-It C3, SPIT® PULSA 800E, 700, 1000 or equivalent nailers.

nVent CADDY Speed Link Universal Support System

NVENT CADDY SPEED LINK SLK SYSTEM

NVENT CADDY SPEED LINK SLK WITH DECKING HOOK

- Complete system includes wire, locking device and pre-assembled decking hook end fitting
- Quickly and easily attaches to hollow metal decking
- Spring-loaded ends snap into decking hole and lock into place
- Innovative design helps protect the wire from sharp edges of decking hole, minimizing risk of damage to wire

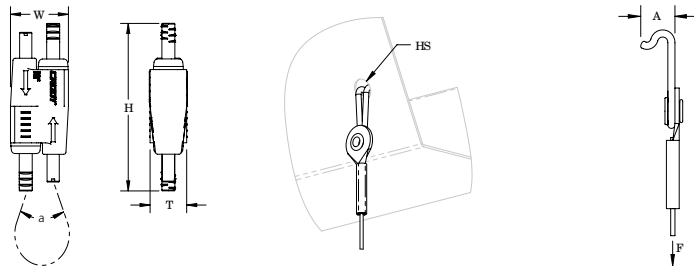
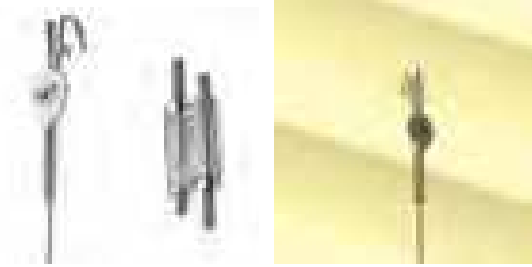

Material: Steel, Zinc Alloy, Polypropylene
 Finish: Electrogalvanized
 Static Load Safety Factor: 5:1
 Complies With: SMACNA HVAC-DCS



Part Number	Article Number	Wire Rope Length	Roof Decking Sheet Thickness	A	Hole Size	Static Load
Wire Rope Diameter: 1.5 mm						
SLK15L1DH	196676	1 m	1.5 mm Max	9.2 mm	8 mm	195 N
SLK15L2DH	196677	2 m	1.5 mm Max	9.2 mm	8 mm	195 N
SLK15L3DH	196504	3 m	1.5 mm Max	9.2 mm	8 mm	195 N
SLK15L5DH	196505	5 m	1.5 mm Max	9.2 mm	8 mm	195 N
Wire Rope Diameter: 2.0 mm						
SLK2L3DH	196532	3 m	1.5 mm Max	9.2 mm	8 mm	440 N
SLK2L5DH	196533	5 m	1.5 mm Max	9.2 mm	8 mm	440 N
SLK2L7DH	196534	7 m	1.5 mm Max	9.2 mm	8 mm	440 N
Height	Width	Thickness	Angle			
55 mm	19 mm	12.5 mm	90° Max			

Load rating is only applicable if the load-bearing capacity of the supporting element (steel decking) is adequate. Check with deck manufacturer for recommended load capacity.

nVent CADDY Speed Link Universal Support System

NVENT CADDY SPEED LINK SLK SYSTEM

NVENT CADDY SPEED LINK SLK WITH HAMMER-ON FLANGE CLIP

- Complete system includes wire, locking device and pre-assembled nVent CADDY Hammer-On Flange Clip end fitting
- Installs with just a hammer
- Fits most beams

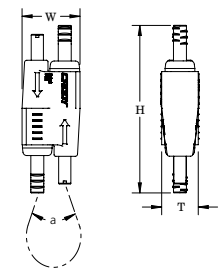
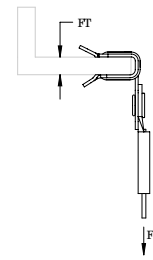
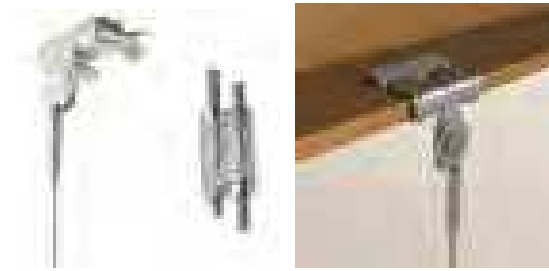

Material: Steel, Polypropylene, Zinc Alloy
 Finish: Electrogalvanized
 Static Load Safety Factor: 5:1
 Complies With: SMACNA HVAC-DCS



Part Number	Article Number	Wire Rope Length	Flange Thickness	Static Load
Wire Rope Diameter: 1.5 mm				
SLK15L34H24	196506	3 m	3 – 8 mm	195 N
SLK15L34H58	196507	3 m	8 – 14 mm	195 N
Wire Rope Diameter: 2.0 mm				
SLK2L34H24	196535	3 m	3 – 8 mm	440 N
SLK2L34H58	196536	3 m	8 – 14 mm	440 N
Height	Width	Thickness	Angle	
55 mm	19 mm	12.5 mm	90° Max	

nVent CADDY Speed Link Universal Support System

NVENT CADDY SPEED LINK SLK SYSTEM

NVENT CADDY SPEED LINK SLK WITH HOOK

- Complete system includes wire, locking device and pre-assembled hook end fitting
- Hooks to a wide range of nVent CADDY fasteners
- Fastens to the building structure or hanging services by looping around and hooking to wire rope
- Easy to remove for applications requiring maintenance
- Spring latch helps provide secure connection
- Insert cable through hole and use bottom side of hook as an end stop
- Also available in Y-hook configuration

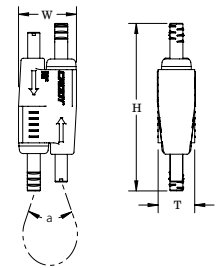
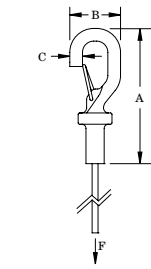
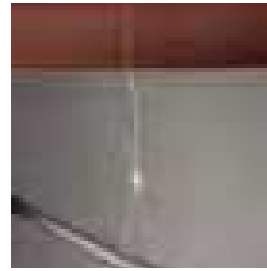
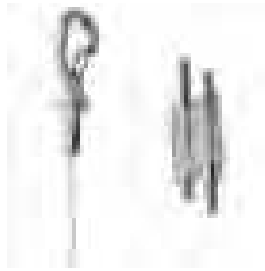

Material: Steel, Polypropylene, Zinc Alloy
 Finish: Electrogalvanized
 Static Load Safety Factor: 5:1



Part Number	Article Number	Wire Rope Length	A	B	C	H	W	T	a	F
Wire Rope Diameter: 1.5 mm										
SLK15L1	196508	1	48.0	18.0	4.5	55	19	12.5	90 Max	195
SLK15L2	196509	2	48.0	18.0	4.5	55	19	12.5	90 Max	195
SLK15L2R2	196614	2	48.0	18.0	4.5	55	19	12.5	90 Max	195
SLK15L3	196510	3	48.0	18.0	4.5	55	19	12.5	90 Max	195
SLK15L3R2	196615	3	48.0	18.0	4.5	55	19	12.5	90 Max	195
SLK15L5	196511	5	48.0	18.0	4.5	55	19	12.5	90 Max	195
SLK15L5R2	196616	5	48.0	18.0	4.5	55	19	12.5	90 Max	195
SLK15L7	196512	7	48.0	18.0	4.5	55	19	12.5	90 Max	195
SLK15L10	196513	10	48.0	18.0	4.5	55	19	12.5	90 Max	195
Wire Rope Diameter: 2.0 mm										
SLK2L1	196537	1	57.0	20.0	5.5	55	19	12.5	90 Max	440
SLK2L2	196538	2	57.0	20.0	5.5	55	19	12.5	90 Max	440
SLK2L2R2	196619	2	57.0	20.0	5.5	55	19	12.5	90 Max	440
SLK2L3	196539	3	57.0	20.0	5.5	55	19	12.5	90 Max	440
SLK2L3R2	196620	3	57.0	20.0	5.5	55	19	12.5	90 Max	440
SLK2L5	196540	5	57.0	20.0	5.5	55	19	12.5	90 Max	440
SLK2L7	196541	7	57.0	20.0	5.5	55	19	12.5	90 Max	440
SLK2L10	196542	10	57.0	20.0	5.5	55	19	12.5	90 Max	440
Wire Rope Diameter: 3.0 mm										
SLK3L1	196700	1	57.6	23.2	6.1	62	24	16.0	90 Max	890
SLK3L2	196701	2	57.6	23.2	6.1	62	24	16.0	90 Max	890
SLK3L3	196702	3	57.6	23.2	6.1	62	24	16.0	90 Max	890
SLK3L3R2	196625	3	57.6	23.2	6.1	62	24	16.0	90 Max	890
SLK3L5	196703	5	57.6	23.2	6.1	62	24	16.0	90 Max	890
SLK3L5R2	196626	5	57.6	23.2	6.1	62	24	16.0	90 Max	890
SLK3L7	196704	7	57.6	23.2	6.1	62	24	16.0	90 Max	890
SLK3L10	196705	10	57.6	23.2	6.1	62	24	16.0	90 Max	890

nVent CADDY Speed Link Universal Support System

NVENT CADDY SPEED LINK SLK SYSTEM

NVENT CADDY SPEED LINK SLK WITH LOOP

- Complete system includes wire, locking device and pre-assembled loop end fitting
- Easy and flexible solution attaches to building structures
- Wire rope wraps around structure and through loop for quick installation
- Ideal for attaching to purlins, beams and other structural members
- Works well in tight or confined spaces
- Loop attaches directly to pipe, ductwork or other hanging assemblies

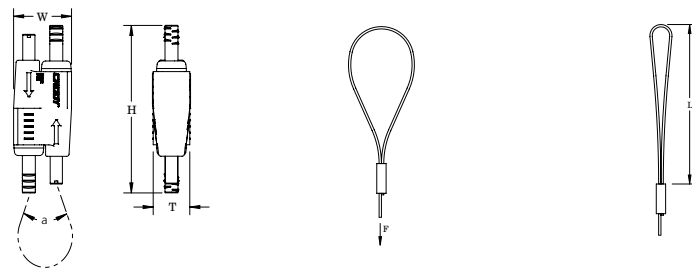
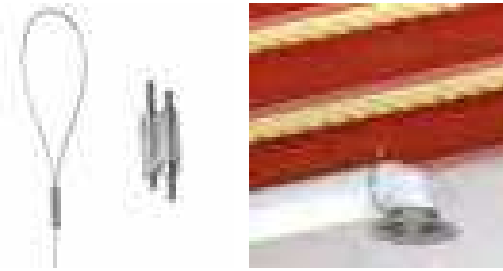

Material: Steel, Polypropylene, Zinc Alloy
 Finish: Electrogalvanized
 Static Load Safety Factor: 5:1



Part Number	Article Number	Wire Rope Length	Length	Height	Width	Thickness	Angle	Static Load	Certifications	Standard Packaging Quantity
Wire Rope Diameter: 1.5 mm										
SLK15L1LP	196601	1 m	101.6 mm	55 mm	19 mm	12.5 mm	90° Max	195 N		20 pc
SLK15L1LPR2	196628	1 m	101.6 mm	55 mm	19 mm	12.5 mm	90° Max	195 N		15 x 2 pc
SLK15L2LP	196514	2 m	101.6 mm	55 mm	19 mm	12.5 mm	90° Max	195 N		20 pc
SLK15L2LPR2	196629	2 m	101.6 mm	55 mm	19 mm	12.5 mm	90° Max	195 N		15 x 2 pc
SLK15L3LP	196515	3 m	101.6 mm	55 mm	19 mm	12.5 mm	90° Max	195 N	cULus, SMACNA	20 pc
SLK15L3LPR2	196630	3 m	101.6 mm	55 mm	19 mm	12.5 mm	90° Max	195 N		15 x 2 pc
SLK15L5LP	196516	5 m	101.6 mm	55 mm	19 mm	12.5 mm	90° Max	195 N		20 pc
SLK15L5LPR2	196631	5 m	101.6 mm	55 mm	19 mm	12.5 mm	90° Max	195 N		15 x 2 pc
SLK15L7LP	196602	7 m	101.6 mm	55 mm	19 mm	12.5 mm	90° Max	195 N		20 pc
SLK15L10LP	196603	10 m	101.6 mm	55 mm	19 mm	12.5 mm	90° Max	195 N		20 pc
Wire Rope Diameter: 2.0 mm										
SLK2L1LP	196604	1 m	101.6 mm	55 mm	19 mm	12.5 mm	90° Max	440 N		10 pc
SLK2L2LP	196543	2 m	101.6 mm	55 mm	19 mm	12.5 mm	90° Max	440 N		10 pc
SLK2L3LP	196544	3 m	101.6 mm	55 mm	19 mm	12.5 mm	90° Max	440 N	cULus, SMACNA	10 pc
SLK2L5LP	196545	5 m	101.6 mm	55 mm	19 mm	12.5 mm	90° Max	440 N		10 pc
SLK2L7LP	196605	7 m	101.6 mm	55 mm	19 mm	12.5 mm	90° Max	440 N		5 pc
SLK2L10LP	196606	10 m	101.6 mm	55 mm	19 mm	12.5 mm	90° Max	440 N		5 pc
Wire Rope Diameter: 3.0 mm										
SLK3L1LP	196706	1 m	101.6 mm	62 mm	24 mm	16.0 mm	90° Max	890 N		10 x 10 pc
SLK3L2LP	196707	2 m	101.6 mm	62 mm	24 mm	16.0 mm	90° Max	890 N		10 x 10 pc
SLK3L3LP	196708	3 m	101.6 mm	62 mm	24 mm	16.0 mm	90° Max	890 N	SMACNA	5 x 10 pc
SLK3L5LP	196709	5 m	101.6 mm	62 mm	24 mm	16.0 mm	90° Max	890 N		5 x 10 pc
SLK3L10LP	196711	10 m	101.6 mm	62 mm	24 mm	16.0 mm	90° Max	890 N		5 x 5 pc

nVent CADDY Speed Link Universal Support System

NVENT CADDY SPEED LINK SLK SYSTEM

NVENT CADDY SPEED LINK SLK WITH THREADED STUD END

- Complete system includes wire, locking device and pre-assembled threaded stud end fitting
- Attaches to structures with threaded anchors or devices with threaded hole
- Connects directly to threaded devices in trapeze assemblies, light fixtures, HVAC assemblies or signage

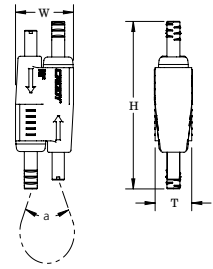
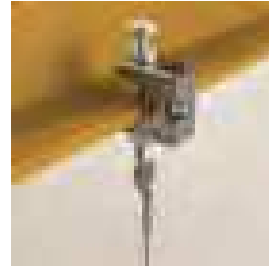

Material: Steel, Polypropylene, Zinc Alloy
 Finish: Electrogalvanized
 Static Load Safety Factor: 5:1
 Complies With: SMACNA HVAC-DCS



Part Number	Article Number	Wire Rope Length	Rod Size	Screw Length	Height	Width	Thickness	Angle	Static Load	Certifications
Wire Rope Diameter: 1.5 mm										
SLK15L1SEM6	196564	1 m	M6	25 mm	55 mm	19 mm	12.5 mm	90° Max	195 N	cULus
SLK15L1SEM8	196565	1 m	M8	45 mm	55 mm	19 mm	12.5 mm	90° Max	195 N	cULus
SLK15L2SEM6	196566	2 m	M6	25 mm	55 mm	19 mm	12.5 mm	90° Max	195 N	cULus
SLK15L2SEM8	196567	2 m	M8	45 mm	55 mm	19 mm	12.5 mm	90° Max	195 N	cULus
SLK15L3SEM6	196568	3 m	M6	25 mm	55 mm	19 mm	12.5 mm	90° Max	195 N	cULus
SLK15L3SEM8	196570	3 m	M8	45 mm	55 mm	19 mm	12.5 mm	90° Max	195 N	cULus
Wire Rope Diameter: 2.0 mm										
SLK2L2SEM8	196559	2 m	M8	45 mm	55 mm	19 mm	12.5 mm	90° Max	440 N	cULus
SLK2L3SEM6	196560	3 m	M6	25 mm	55 mm	19 mm	12.5 mm	90° Max	440 N	cULus
SLK2L3SEM8	196561	3 m	M8	45 mm	55 mm	19 mm	12.5 mm	90° Max	440 N	cULus
SLK2L5SEM6	196562	5 m	M6	25 mm	55 mm	19 mm	12.5 mm	90° Max	440 N	cULus
SLK2L5SEM8	196563	5 m	M8	45 mm	55 mm	19 mm	12.5 mm	90° Max	440 N	cULus
Wire Rope Diameter: 3.0 mm										
SLK3L10SEM10	196721	10 m	M10	45 mm	62 mm	24 mm	16.0 mm	90° Max	890 N	

nVent CADDY Speed Link Universal Support System

NVENT CADDY SPEED LINK SLK SYSTEM

NVENT CADDY SPEED LINK SLK WITH WEDGE ANCHOR

- Complete system includes wire, locking device and wedge anchor from Powers Fasteners, Inc.
- Quickly and easily attaches into cracked and non-cracked concrete
- No special tools required
- ETA-13/0106 approval available for wedge anchor from Powers Fasteners, Inc

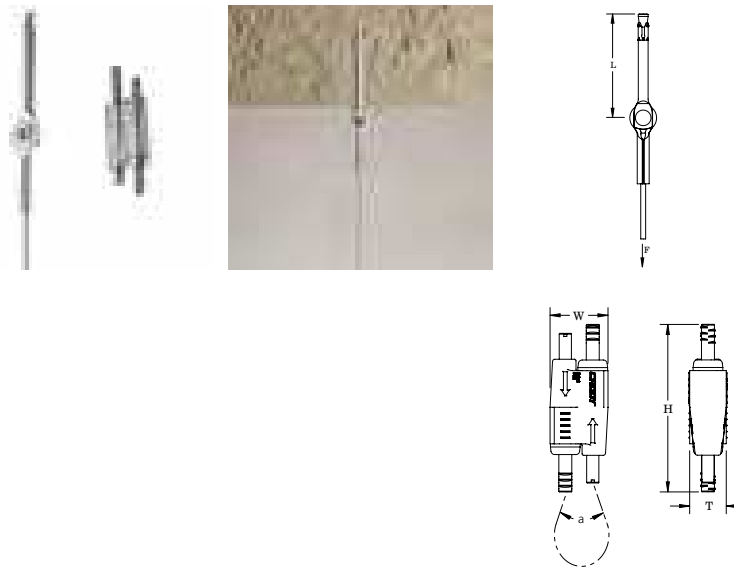

Material: Steel, Polypropylene, Zinc Alloy
 Finish: Electrogalvanized
 Static Load Safety Factor: 5:1
 Complies With: SMACNA HVAC-DCS

Part Number	Article Number	Wire Rope Length	Length	Height	Width	Thickness	Angle	Static Load
Wire Rope Diameter: 1.5 mm								
SLK15L1WA6	196670	1 m	63.5 mm	55 mm	19 mm	12.5 mm	90° Max	195 N
SLK15L2WA6	196671	2 m	63.5 mm	55 mm	19 mm	12.5 mm	90° Max	195 N
SLK15L3WA6	196672	3 m	63.5 mm	55 mm	19 mm	12.5 mm	90° Max	195 N
SLK15L5WA6	196673	5 m	63.5 mm	55 mm	19 mm	12.5 mm	90° Max	195 N
Wire Rope Diameter: 2.0 mm								
SLK2L2WA6	196734	2 m	63.5 mm	55 mm	19 mm	12.5 mm	90° Max	440 N
SLK2L3WA6	196735	3 m	63.5 mm	55 mm	19 mm	12.5 mm	90° Max	440 N
SLK2L5WA6	196736	5 m	63.5 mm	55 mm	19 mm	12.5 mm	90° Max	440 N
SLK2L7WA6	196737	7 m	63.5 mm	55 mm	19 mm	12.5 mm	90° Max	440 N
Wire Rope Diameter: 3.0 mm								
SLK3L1WA6	196722	1 m	63.5 mm	62 mm	24 mm	16.0 mm	90° Max	890 N
SLK3L2WA6	196723	2 m	63.5 mm	62 mm	24 mm	16.0 mm	90° Max	890 N
SLK3L5WA6	196725	5 m	63.5 mm	62 mm	24 mm	16.0 mm	90° Max	890 N
SLK3L7WA6	196726	7 m	63.5 mm	62 mm	24 mm	16.0 mm	90° Max	890 N
SLK3L10WA6	196727	10 m	63.5 mm	62 mm	24 mm	16.0 mm	90° Max	890 N
Drill Bit Diameter			Drill Hole Depth			Embedment Depth		
6 mm			60 mm			55 mm Min		

nVent CADDY Speed Link Universal Support System

NVENT CADDY SPEED LINK SLK SYSTEM

NVENT CADDY SPEED LINK SLK WITH TOGGLE

- Complete system includes wire, locking device and pre-assembled toggle end fitting
- Attaches to clearance holes in a variety of structures or hanging devices
- Ideal for supporting lighting fixtures
- Also available in Y-toggle configuration

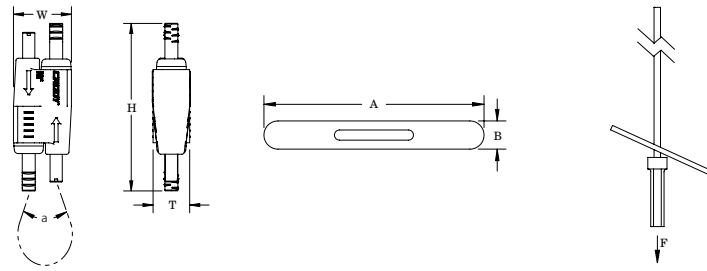

Material: Steel, Zinc Alloy, Polypropylene
 Finish: Electrogalvanized
 Static Load Safety Factor: 5:1
 Complies With: SMACNA HVAC-DCS
 Wire Rope Diameter: 1.5 mm



Part Number	Article Number	Wire Rope Length	A	B	Static Load	Standard Packaging Quantity
SLK15L1T	196521	1 m	39 mm	5 mm	195 N	20 pc
SLK15L2T	196522	2 m	39 mm	5 mm	195 N	20 pc
SLK15L2TR2	196644	2 m	39 mm	5 mm	195 N	15 x 2 pc
SLK15L3T	196523	3 m	39 mm	5 mm	195 N	20 pc
SLK15L3TR2	196645	3 m	39 mm	5 mm	195 N	15 x 2 pc
SLK15L5T	196524	5 m	39 mm	5 mm	195 N	20 pc
SLK15L7T	196525	7 m	39 mm	5 mm	195 N	20 pc
SLK15L10T	196526	10 m	39 mm	5 mm	195 N	20 pc

Height	Width	Thickness	Angle
55 mm	19 mm	12.5 mm	90° Max

nVent CADDY Speed Link Universal Support System

NVENT CADDY SPEED LINK SLK SYSTEM

NVENT CADDY SPEED LINK SLK WITH Y-HOOK

- Complete system includes wire, locking device and two pre-assembled hook end fittings
- Fastens to the building structure and hooks to hanging services and tray
- Spring latch helps provide secure connection
- Convenient design allows one hook to be temporarily detached for maintenance or to add cables to the tray
- Single drop with double hook provides increased stability to the system
- Also available in a single-hook end fitting configuration

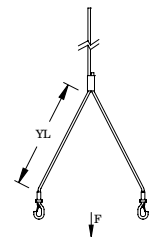
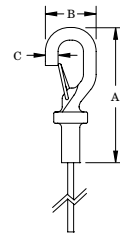
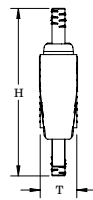
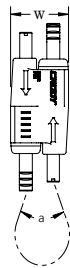
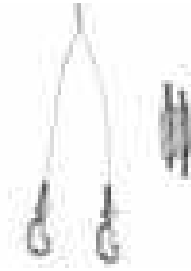

Material: Steel, Zinc Alloy, Polypropylene
 Finish: ElectroGalvanized
 Static Load Safety Factor: 5:1
 Complies With: SMACNA HVAC-DCS
 Wire Rope Diameter: 2 mm



Part Number	Article Number	Wire Rope Length	Wire Rope "Y" Length	A	B	C	Static Load	Standard Packaging Quantity
SLK2YH500L2	196549	2 m	0.5 m	58.4 mm	22.9 mm	6.4 mm	440 N	10 pc
SLK2YH500L3	196550	3 m	0.5 m	58.4 mm	22.9 mm	6.4 mm	440 N	10 pc
SLK2YH500L7	196551	7 m	0.5 m	58.4 mm	22.9 mm	6.4 mm	440 N	10 pc

Height	Width	Thickness	Angle
55 mm	19 mm	12.5 mm	90° Max

nVent CADDY Speed Link Universal Support System

NVENT CADDY SPEED LINK SLK SYSTEM

NVENT CADDY SPEED LINK SLK WITH Y-TOGGLE

- Complete system includes wire, locking device and two pre-assembled toggle end fittings
- Attaches to clearance holes in a variety of structures or hanging devices
- Ideal for supporting lighting fixtures

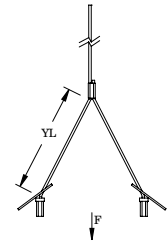
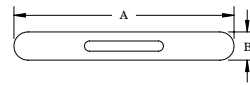
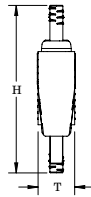
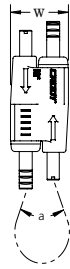
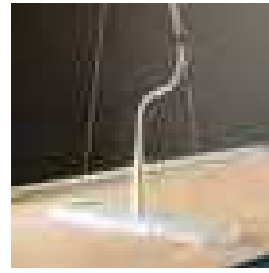
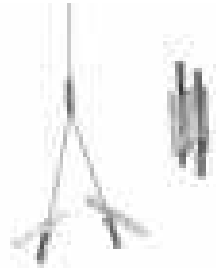

Material: Steel, Zinc Alloy, Polypropylene
 Finish: Electrogalvanized
 Static Load Safety Factor: 5:1
 Complies With: SMACNA HVAC-DCS



Part Number	Article Number	Wire Rope Length	Wire Rope "Y" Length	A	B	Static Load	Standard Packaging Quantity
Wire Rope Diameter: 1.5 mm							
SLK15Y300L3R2	196648	3 m	0.3 m	39 mm	5 mm	195 N	20 x 2 pc
SLK15Y500L3	196528	3 m	0.5 m	39 mm	5 mm	195 N	20 pc
Wire Rope Diameter: 2.0 mm							
SLK2Y500L3	196554	3 m	0.5 m	42 mm	8 mm	440 N	10 pc
SLK2Y300L7	196556	7 m	0.3 m	42 mm	8 mm	440 N	10 pc
Height		Width		Thickness		Angle	
55 mm		19 mm		12.5 mm		90° Max	

nVent CADDY Speed Link Universal Support System

NVENT CADDY SPEED LINK SLS SYSTEM

NVENT CADDY SPEED LINK SLS WITH DECKING HOOK

- Complete system includes wire, locking device and pre-assembled decking hook end fitting
- Quickly and easily attaches to hollow metal decking
- Spring-loaded ends snap into decking hole and lock into place
- Innovative design helps protect the wire from sharp edges of decking hole, minimizing risk of damage to wire
- Finger tightening of nut secures the locking device into position without tools
- Installs in strut profiles without the need to insert fingers or tools into the strut

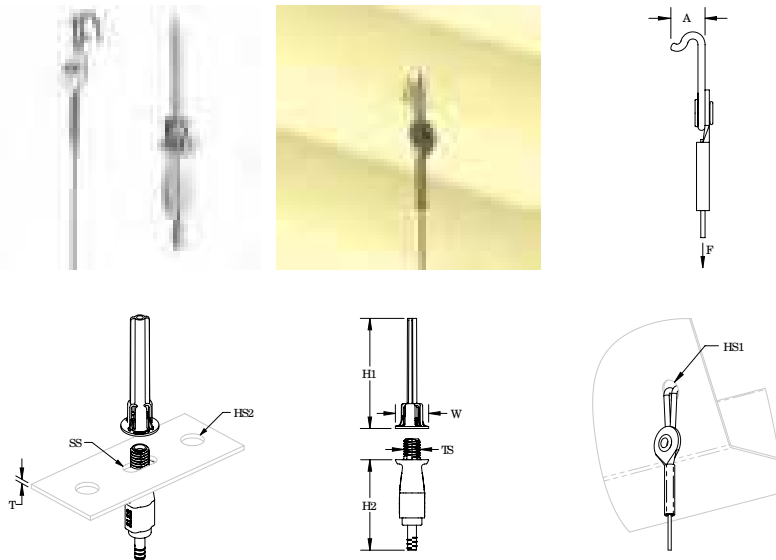

Material: Steel, Zinc Alloy, Polypropylene
 Finish: Electrogalvanized
 Static Load Safety Factor: 5:1
 Complies With: SMACNA HVAC-DCS
 Wire Rope Diameter: 2 mm



Part Number	Article Number	Wire Rope Length	Roof Decking Sheet Thickness	A	Hole Size 1	Static Load
SLS2L3DH	196753	3 m	1.5 mm Max	9.2 mm	8 mm	270 N
SLS2L5DH	196754	5 m	1.5 mm Max	9.2 mm	8 mm	270 N
SLS2L7DH	196755	7 m	1.5 mm Max	9.2 mm	8 mm	270 N

Thread Size	Height 1	Height 2	Width	Thickness	Hole Size 2	Slot Size
M8	53 mm	46.5 mm	16 mm	4 mm Max	8 – 10 mm	8 x 6.5 mm - 8 x 10 mm

The 2 mm locking device is compatible with C-Channel Types E0 and E0L.
 Total load per wire on a multi-tier trapeze must not exceed static load.
 Load rating is only applicable if the load-bearing capacity of the supporting element (steel decking) is adequate.
 Check with deck manufacturer for recommended load capacity.

nVent CADDY Speed Link Universal Support System

NVENT CADDY SPEED LINK SLS SYSTEM

NVENT CADDY SPEED LINK SLS WITH HOOK

- Complete system includes wire, locking device and pre-assembled hook end fitting
- Hooks to a wide range of nVent CADDY fasteners
- Fastens to the building structure or hanging services by looping around and hooking to wire rope
- Easy to remove for applications requiring maintenance
- Spring latch helps provide secure connection
- Insert cable through hole and use bottom side of hook as an end stop
- Finger tightening of nut secures the locking device into position without tools
- Installs in strut profiles without the need to insert fingers or tools into the strut

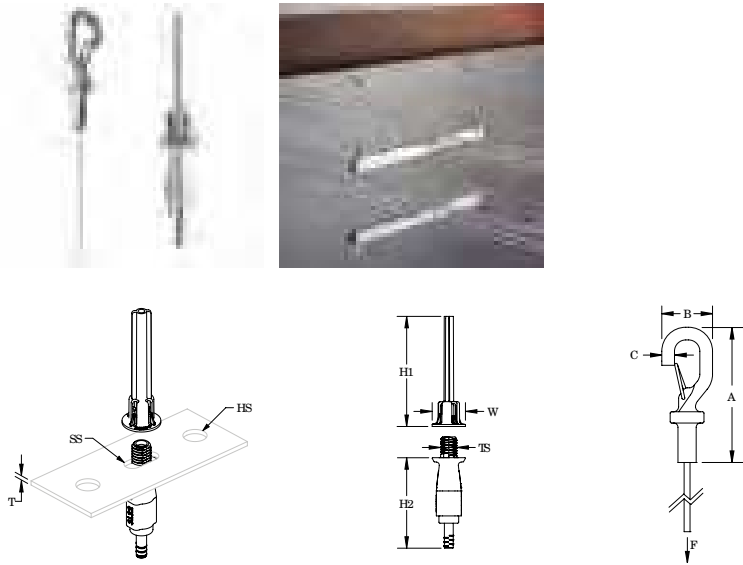

Material: Steel, Zinc Alloy, Polypropylene
 Finish: Electrogalvanized
 Static Load Safety Factor: 5:1
 Complies With: SMACNA HVAC-DCS



Part Number	Article Number	Wire Rope Length	A	B	C	Height 1	Height 2	Thread Size	Width	Hole Size
Wire Rope Diameter: 2 mm										
SLS2L1	196741	1 m	57.0 mm	20.0 mm	5.5 mm	53 mm	43.5 mm	M8	16 mm	8 – 10 mm
SLS2L2	196742	2 m	57.0 mm	20.0 mm	5.5 mm	53 mm	43.5 mm	M8	16 mm	8 – 10 mm
SLS2L3	196743	3 m	57.0 mm	20.0 mm	5.5 mm	53 mm	43.5 mm	M8	16 mm	8 – 10 mm
SLS2L5	196744	5 m	57.0 mm	20.0 mm	5.5 mm	53 mm	43.5 mm	M8	16 mm	8 – 10 mm
SLS2L7	196745	7 m	57.0 mm	20.0 mm	5.5 mm	53 mm	43.5 mm	M8	16 mm	8 – 10 mm
SLS2L10	196746	10 m	57.0 mm	20.0 mm	5.5 mm	53 mm	43.5 mm	M8	16 mm	8 – 10 mm
Wire Rope Diameter: 3 mm										
SLS3L1	196747	1 m	57.6 mm	23.2 mm	6.1 mm	53 mm	46.5 mm	M12	20 mm	12 – 14 mm
SLS3L2	196748	2 m	57.6 mm	23.2 mm	6.1 mm	53 mm	46.5 mm	M12	20 mm	12 – 14 mm
SLS3L3	196749	3 m	57.6 mm	23.2 mm	6.1 mm	53 mm	46.5 mm	M12	20 mm	12 – 14 mm
SLS3L5	196750	5 m	57.6 mm	23.2 mm	6.1 mm	53 mm	46.5 mm	M12	20 mm	12 – 14 mm
SLS3L7	196751	7 m	57.6 mm	23.2 mm	6.1 mm	53 mm	46.5 mm	M12	20 mm	12 – 14 mm
SLS3L10	196752	10 m	57.6 mm	23.2 mm	6.1 mm	53 mm	46.5 mm	M12	20 mm	12 – 14 mm

The 2 mm locking device is compatible with C-Channel Types E0 and E0L.
 The 3 mm locking device is compatible with C-Channel Types E1, E2, E2L, E3, E4, E5, Strut Channel Type C, Slotted, Strut Channel Type A, Slotted, Strut Channel Type AS, Perforated, Strut Channel Type CC, Slotted, Strut Channel Type AA, Slotted.
 Total load per wire on a multi-tier trapeze must not exceed static load.

nVent CADDY Speed Link Universal Support System

NVENT CADDY SPEED LINK SLS SYSTEM

NVENT CADDY SPEED LINK SLS WITH THREADED STUD END

- Complete system includes wire, locking device and pre-assembled threaded stud end fitting
- Attaches to structures with threaded anchors or devices with threaded hole
- Finger tightening of nut secures the locking device into position without tools
- Installs in strut profiles without the need to insert fingers or tools into the strut

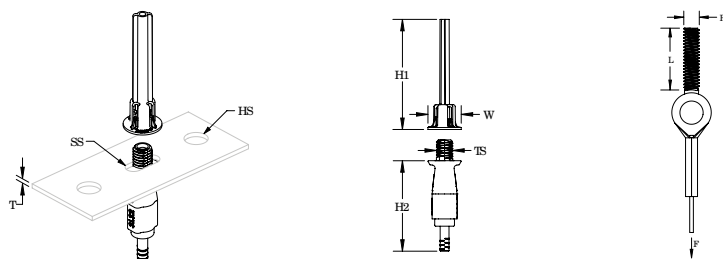

Material: Steel, Polypropylene, Zinc Alloy
 Finish: Electrogalvanized
 Static Load Safety Factor: 5:1
 Complies With: SMACNA HVAC-DCS
 Wire Rope Diameter: 2 mm



Part Number	Article Number	Wire Rope Length	Rod Size	Screw Length	Static Load
SLS2L2SEM8	196756	2 m	M8	45 mm	270 N
SLS2L3SEM8	196757	3 m	M8	45 mm	270 N

Thread Size	Height 1	Height 2	Width	Thickness	Hole Size	Slot Size
M8	53 mm	43.5 mm	16 mm	4 mm Max	8 – 10 mm	8 x 6.5 mm - 8 x 10 mm

The 2 mm locking device is compatible with C-Channel Types E0 and E0L.
 Total load per wire on a multi-tier trapeze must not exceed static load.

nVent CADDY Speed Link Universal Support System

NVENT CADDY SPEED LINK SLS SYSTEM

NVENT CADDY SPEED LINK SLS WITH WEDGE ANCHOR

- Complete system includes wire, locking device and wedge anchor from Powers Fasteners, Inc.
- Quickly and easily attaches into cracked and non-cracked concrete
- Installs in strut profiles without the need to insert fingers or tools into the strut
- Finger tightening of nut secures the locking device into position without tools
- No special tools required
- ETA-13/0106 approval available for wedge anchor from Powers Fasteners, Inc

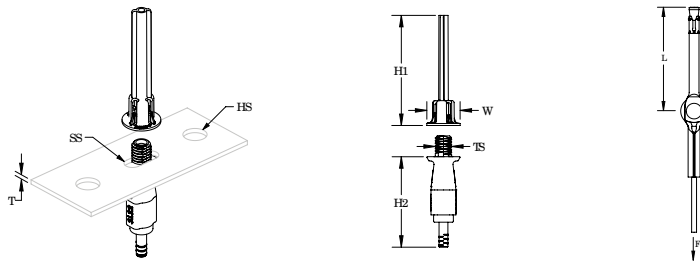
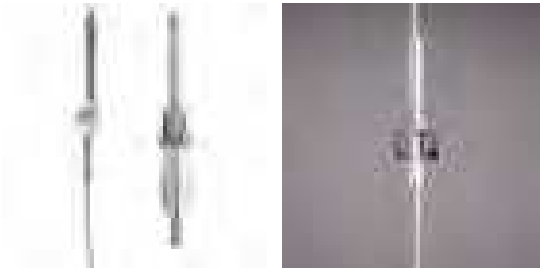

Material: Steel, Polypropylene, Zinc Alloy
 Finish: Electrogalvanized
 Static Load Safety Factor: 5:1
 Complies With: SMACNA HVAC-DCS
 Wire Rope Diameter: 2 mm



Part Number	Article Number	Wire Rope Length	Length	Drill Bit Diameter	Drill Hole Depth	Embedment Depth	Static Load
SLS2L3WA6	196759	3 m	63.5 mm	6 mm	60 mm	55 mm Min	270 N
SLS2L5WA6	196760	5 m	63.5 mm	6 mm	60 mm	55 mm Min	270 N
SLS2L7WA6	196761	7 m	63.5 mm	6 mm	60 mm	55 mm Min	270 N

Thread Size	Height 1	Height 2	Width	Thickness	Hole Size	Slot Size
M8	53 mm	43.5 mm	16 mm	4 mm Max	8 – 10 mm	8 x 6.5 mm - 8 x 10 mm

The 2 mm locking device is compatible with C-Channel Types E0 and E0L.
 Total load per wire on a multi-tier trapeze must not exceed static load.

nVent CADDY Speed Link Universal Support System

NVENT CADDY SPEED LINK SLS SYSTEM

NVENT CADDY SPEED LINK SLS TRAPEZE KIT

- Out of the box trapeze solution includes Telescoping Strut Replacement, wire rope with pre-assembled hook end-fitting, and two nVent CADDY Speed Link SLS locking devices
- Telescopes to the desired length and is locked in place by snapping closed a spring retainer clip
- Standard strut profile runs the entire length of the Telescoping Strut Replacement, allowing most standard fittings to be placed anywhere between the wire rope supports
- Supports up to seven 2" (50 DN) conduits, six 2" (50 DN) water filled pipes at 10' (3 m) spacing, or up to 18" (450 mm) cable tray
- Conduit and pipe can be placed directly on the strut profile, saving vertical space in buildings with limited room for installation
- Fastens to the building structure or hanging services by looping around and hooking to wire rope
- Hooks to a wide range of nVent CADDY fasteners
- Finger tightening of nut secures the locking device into position without tools
- Installs in telescoping strut replacement without the need to insert fingers or tools into the channel
- Easy to remove for applications requiring maintenance

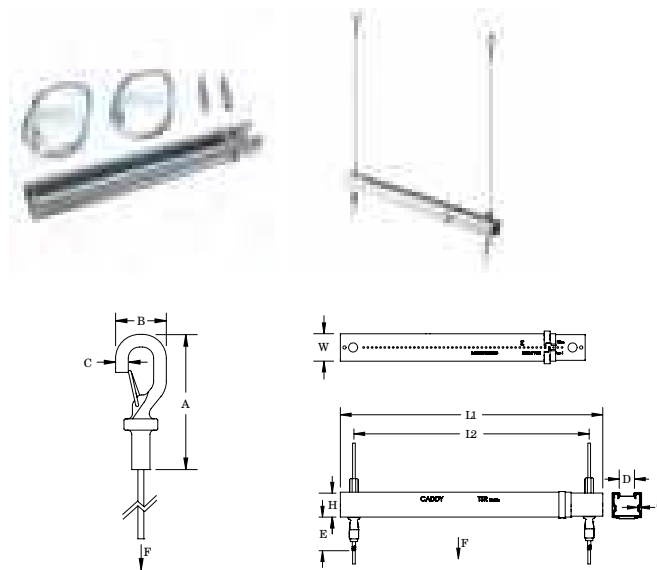

Material: Steel, Zinc Alloy, Polyamide
 Finish: Electrogalvanized, Pregalvanized
 Wire Rope Diameter: 3 mm

Part Number	Article Number	Wire Rope Length	Length 1	Length 2	Height	Width	Thickness
TSR1220SLS3	366595	3 m	356 – 546 mm	318 – 508 mm	35 mm	41 mm	1 mm

A	B	C	D	E	Static Load 1	Static Load 2
57.6 mm	23.2 mm	6.1 mm	22.2 mm	46.5 mm	1,330 N	880 N

Static Load 1 represents a distributed load for 12" - 20" (300 - 500 mm) installations and a point load for 12" - 16" (300 - 400 mm) installations.
 Static Load 2 represents a point load for 16" - 20" (400 - 500 mm) installations.

nVent CADDY Speed Link Universal Support System

NVENT CADDY SPEED LINK LD SYSTEM

NVENT CADDY SPEED LINK LD WITH HOOK

- Complete system includes wire, locking device and pre-assembled hook end fitting
- Hooks to a wide range of nVent CADDY fasteners
- Fastens to the building structure or hanging services by looping around and hooking to wire rope
- Easy to remove for applications requiring maintenance
- Spring latch helps provide secure connection
- Insert cable through hole and use bottom side of hook as an end stop

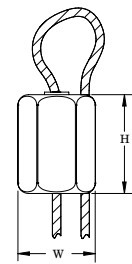
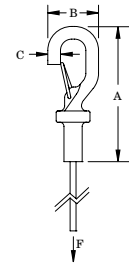
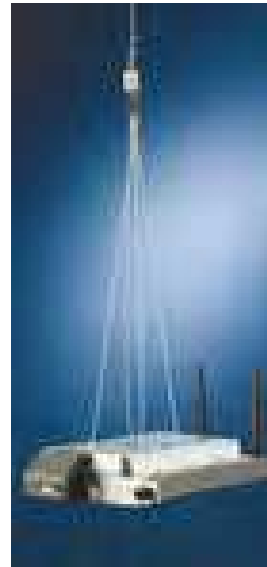

Material: Stainless Steel 304 (EN 1.4301)
 Static Load Safety Factor: 5:1
 Wire Rope Diameter: 1.5 mm



Part Number	Article Number	Wire Rope Length	A	B	C	Static Load	Certifications	Standard Packaging Quantity
SLD15L2S	195935	2 m	58.4 mm	22.9 mm	6.4 mm	195 N	cULus, ITB	20 x 2 pc
SLD15L5S	195940	5 m	58.4 mm	22.9 mm	6.4 mm	195 N	cULus, ITB	20 x 2 pc
SLD15L10S	195945	10 m	58.4 mm	22.9 mm	6.4 mm	195 N	cULus, ITB	20 x 2 pc

Height	Width
19 mm	12.7 mm

NVENT CADDY SPEED LINK SLDM WITH HOOK

- Complete system includes wire, locking device and pre-assembled hook end fitting
- Ideal for supporting lighting, ductwork and other installation projects
- Sleek, low-profile locking device reduces visual impact
- Keyless locking device is adjustable even after installation

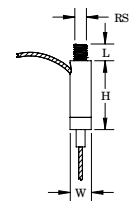
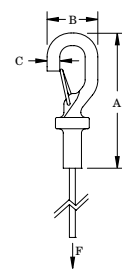
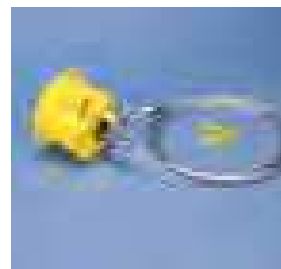

Material: Steel
 Finish: Electrogalvanized
 Static Load Safety Factor: 5:1
 Wire Rope Diameter: 1.5 mm

Part Number	Article Number	Wire Rope Length	A	B	C	Static Load	Certifications
SLDM615L1	196028	1 m	58.4 mm	22.9 mm	6.4 mm	195 N	ITB
SLDM615L2	196029	2 m	58.4 mm	22.9 mm	6.4 mm	195 N	ITB

Rod Size	Length	Height	Width
M6	7 mm	24.5 mm	9.2 mm

nVent CADDY Speed Link Universal Support System

NVENT CADDY SPEED LINK SLDM SYSTEM

NVENT CADDY SPEED LINK SLDM WITH TOGGLE

- Complete system includes wire, locking device and pre-assembled toggle end fitting
- Attaches to clearance holes in a variety of structures or hanging devices
- Ideal for supporting lighting fixtures
- Sleek, low-profile locking device reduces visual impact
- Keyless locking device is adjustable even after installation

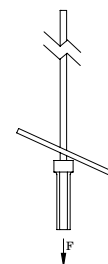
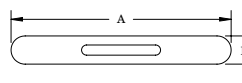
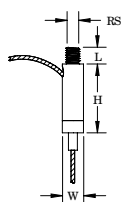

Material: Steel
Finish: Electrogalvanized
Wire Rope Diameter: 1.5 mm

Part Number	Article Number	Wire Rope Length	A	B	Static Load
SLDM615L2T	196044	2 m	39 mm	5 mm	195 N

Rod Size	Length	Height	Width
M6	7 mm	24.5 mm	9.2 mm

NVENT CADDY SPEED LINK Y-HOOK WITH EYELET EXTENSION

- Double hook offers easy attachment to basket tray, cable tray or lighting
- Convenient design allows one hook to be temporarily detached for maintenance or to add cables to the tray
- Y-design provides improved stability
- Spring latch helps provide secure connection

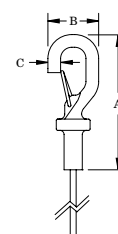
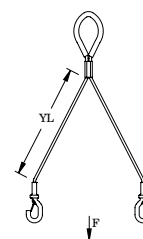
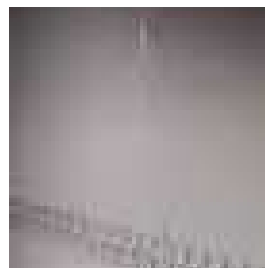

Material: Steel
Finish: Electrogalvanized
Static Load Safety Factor: 5:1



Part Number	Article Number	Wire Rope "Y" Length	A	B	C	Static Load	Certifications
Wire Rope Diameter: 2 mm							
SLD2YH500	196015	0.5 m	58.4 mm	22.9 mm	6 mm	440 N	cULus, ITB
Wire Rope Diameter: 3 mm							
SLD3YH800	195998	0.8 m	58.4 mm	22.9 mm	6 mm	880 N	cULus, ITB

nVent CADDY Speed Link locking device not included.

nVent CADDY Speed Link Universal Support System

NVENT CADDY SPEED LINK EXTENSIONS

NVENT CADDY SPEED LINK Y-TOGGLE WITH EYELET EXTENSION

- Attaches to clearance holes in a variety of structures or hanging devices
- Ideal for supporting lighting fixtures
- Y-design provides improved stability

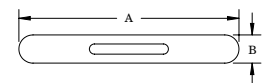
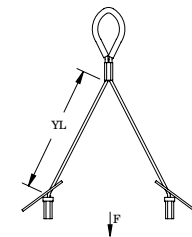

Material: Steel
 Finish: Electrogalvanized
 Static Load Safety Factor: 5:1



Part Number	Article Number	Wire Rope "Y" Length	A	B	Static Load	Certifications	Standard Packaging Quantity
Wire Rope Diameter: 1.5 mm							
SLD15Y500	195960	0.5 m	39 mm	5 mm	195 N	cULus, ITB	20 pc
Wire Rope Diameter: 2.0 mm							
SLD2Y500	176870	0.5 m	42 mm	8 mm	440 N	cULus, ITB	20 pc

nVent CADDY Speed Link locking device not included.

NVENT CADDY SPEED LINK QUAD-TOGGLE WITH EYELET EXTENSION

- Secure hanging solution for use on control access points, projectors, etc.

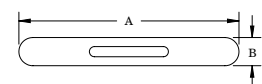
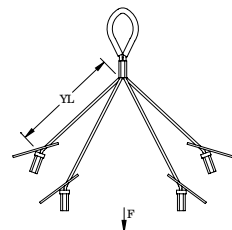
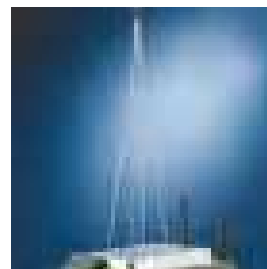

Material: Steel
 Finish: Electrogalvanized
 Static Load Safety Factor: 5:1



Part Number	Article Number	Wire Rope Diameter	Wire Rope "Y" Length	A	B	Static Load	Certifications
SLD15QT250	196007	1.5 mm	0.25 m	39 mm	5 mm	195 N	cULus, ITB

nVent CADDY Speed Link locking device not included.

nVent CADDY Speed Link Universal Support System

NVENT CADDY SPEED LINK LOCKING DEVICES AND WIRE ROPE

NVENT CADDY SPEED LINK SLK SPOOL KIT

- Kit includes spool of nVent CADDY Speed Link steel wire and nVent CADDY Speed Link SLK locking devices
- Wire spool and locking devices are packaged together, simplifying transportation to the jobsite and reducing inventory
- Packaging allows end-users to pull and cut any length of wire that is needed without having to take the spool out of the box
- Ideal for rework and installations where custom lengths of wire may be needed
- Wire rope constructed from seven bundles of seven strands each of steel aircraft wire
- Push/pull keyless release allows easy adjustments
- Low-profile locking device minimizes visual impact
- Cable spread of 90 degrees allows positioning the device closer to the load
- Keyless release tubes are easy to operate while wearing gloves
- Double-sided locking mechanism enables simple height adjustment

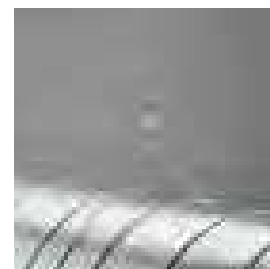

Material: Steel
Finish: Electrogalvanized

Part Number	Article Number	Wire Rope Diameter	Length	Number of Locking Devices
SLK15L500PACK	196045	1.5 mm	150 m	100
SLK15L50MPACK	196046	1.5 mm	50 m	25
SLK2L100PACK	196047	2.0 mm	100 m	50

NVENT CADDY SPEED LINK SLK SPOOL KIT WITH WIRE ROPE CUTTER

- Includes two nVent CADDY Speed Link SLK Spool Kits with wire spools and locking devices and one wire rope cutter
- Wire spool and locking devices are packaged together, simplifying transportation to the jobsite and reducing inventory
- Packaging allows end-users to pull and cut any length of wire that is needed without having to take the spool out of the box
- Ideal for rework and installations where custom lengths of wire may be needed
- Wire rope constructed from seven bundles of seven strands each of steel aircraft wire
- Push/pull keyless release allows easy adjustments
- Low-profile locking device minimizes visual impact
- Cable spread of 90 degrees allows positioning the device closer to the load
- Keyless release tubes are easy to operate while wearing gloves
- Double-sided locking mechanism enables simple height adjustment

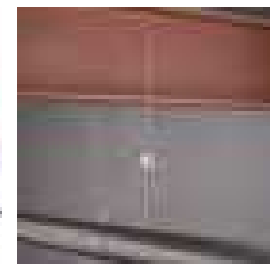

Material: Steel
Finish: Electrogalvanized

Part Number	Article Number	Wire Rope Diameter	Length	Number of Locking Devices
SLK15PROMOPACK	196048	1.5 mm	100 m	50

Length and Number of Locking Devices is the combined total of two spool kits. Each individual spool kit includes 50 m (164') of wire rope and 25 locking devices.

nVent CADDY Speed Link Universal Support System

NVENT CADDY SPEED LINK LOCKING DEVICES AND WIRE ROPE

NVENT CADDY SPEED LINK SLK LOCKING DEVICE

- Push/pull keyless release allows easy adjustments
- Low-profile locking device minimizes visual impact
- Cable spread of 90 degrees allows positioning the device closer to the load
- Keyless release tubes are easy to operate while wearing gloves
- Double-sided locking mechanism enables simple height adjustment

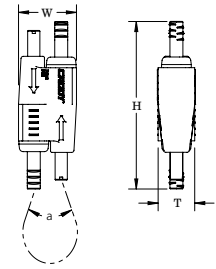

Material: Steel, Polypropylene, Zinc Alloy



Part Number	Article Number	Wire Rope Diameter	Height	Width	Thickness	Angle	Certifications	Standard Packaging Quantity
SLK2C200	196600	1.5 – 2.0 mm	55 mm	19 mm	12.5 mm	90° Max	cULus, ITB	200 pc
SLK3C200	196730	3.0 mm	62 mm	24 mm	16.0 mm	90° Max		200 pc

Locking devices are only to be used with nVent CADDY Speed Link wire spools and accessories with the same specified Wire Rope Diameter as the locking device. Do not use with any other wires.

NVENT CADDY SPEED LINK SLS LOCKING DEVICE

- Single barrel locking device allows for quickprefabrication of strut or brackets
- Push-on nut quickly and securely installs to strut or bracket to keep the locking device in position and eases installation
- Finger tightening of nut secures the locking device into position without tools
- Installs in strut profiles without the need to insert fingers or tools into the strut
- Push-on nut guides the cable into the locking device and brings stability to the support
- Installs with open side of the strut channel facing up or down for more flexibility

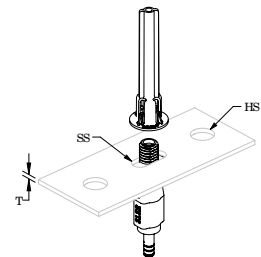
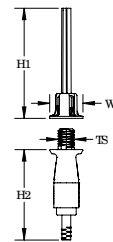

Material: Steel, Polypropylene, Zinc Alloy



Part Number	Article Number	Wire Rope Diameter	Thread Size	Height 1	Height 2	Width	Thickness	Hole Size	Slot Size
SLS2C50	196739	2 mm	M8	53 mm	43.5 mm	16 mm	4 mm Max	8 – 10 mm	8 x 6.5 mm - 8 x 10 mm
SLS3C50	196740	3 mm	M12	53 mm	46.5 mm	20 mm	6 mm Max	12 – 14 mm	12 x 10 mm - 12 x 14 mm

The 2 mm locking device is compatible with C-Channel Types E0 and E0L.
 The 3 mm locking device is compatible with C-Channel Types E1, E2, E2L, E3, E4, E5, Strut Channel Type C, Slotted, Strut Channel Type A, Slotted, Strut Channel Type AS, Perforated, Strut Channel Type CC, Slotted, Strut Channel Type AA, Slotted. Locking devices are only to be used with nVent CADDY Speed Link wire spools and accessories with the same specified Wire Rope Diameter as the locking device. Do not use with any other wires.

nVent CADDY Speed Link Universal Support System

NVENT CADDY SPEED LINK LOCKING DEVICES AND WIRE ROPE

NVENT CADDY SPEED LINK LD LOCKING DEVICE

- Low-profile locking device minimizes visual impact
- Suitable for 1.5 mm nVent CADDY Speed Link cable

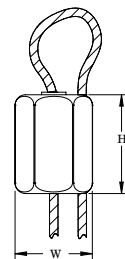
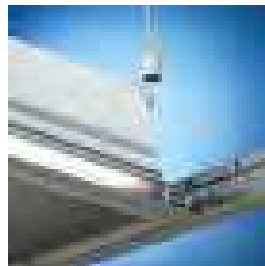

Material: Stainless Steel 304 (EN 1.4301)

Part Number	Article Number	Wire Rope Diameter	Height	Width
SLJR200	196008	1.5 mm	19 mm	12.7 mm

The 1.5 mm locking devices are only to be used with the SLC15L1000SP and SLC15L50MSP wire spools, or any other 1.5 mm nVent CADDY Speed Link accessories. Do not use with any other wires.

WIRE SPOOL

- Spool with nVent CADDY Speed Link steel wire
- Wire rope constructed from seven bundles of seven strands each of steel aircraft wire



Material: Steel
Finish: Electrogalvanized

Part Number	Article Number	Wire Rope Diameter	Length	Static Load
SLC15L50MSP	196023	1.5 mm	50 m	195 N
SLC15L1000SP	196001	1.5 mm	300 m	195 N
SLC2L100SP	196022	2.0 mm	100 m	440 N
SLC2L1000SP	196002	2.0 mm	300 m	440 N
SLC3L1000SP	196003	3.0 mm	300 m	880 N

WIRE ROPE CUTTER

- Designed to reduce wire rope fraying



Material: Steel

Part Number	Article Number
SLWC	195853

nVent CADDY Speed Link Universal Support System

NVENT CADDY SPEED LINK ACCESSORIES

AIR DUCT CORNER PROTECTOR

- Includes rib to keep the wire rope in place
- Prevents the wire rope from damaging the duct

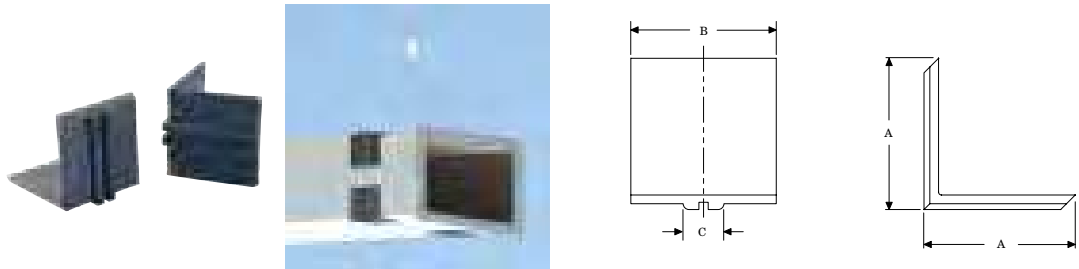

Material: Polyvinylchloride
Color: Black

Part Number	Article Number	A	B	C
SLADCP	195851	52 mm	50 mm	14 mm

AIR DUCT SUPPORT ATTACHMENT

- Angled bracket for installation on to round or square duct
- Designed to accept nVent CADDY Speed Link wire rope or hook

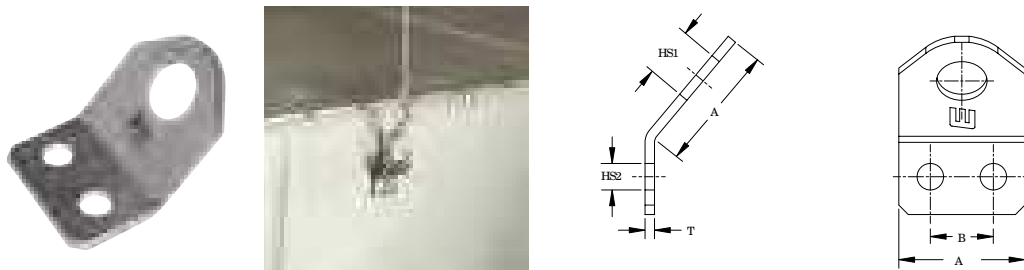

Material: Steel
Finish: Electrogalvanized

Part Number	Article Number	Hole Size 1	Hole Size 2	A	B	Thickness
SLADS	195852	8 mm	4.2 mm	20 mm	10 mm	1.5 mm

nVent CADDY Speed Link Universal Support System

NVENT CADDY SPEED LINK ACCESSORIES

CONCRETE FIXING EYEBOLT SCREW

- For use in concrete and brick
- Includes drill bit adaptor for easy installation

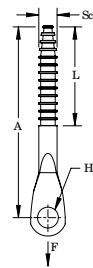

Material: Steel
Finish: Electrogalvanized

Part Number	Article Number	Hole Size	Screw Diameter	Screw Length	A	Drill Bit Diameter	Static Load
CFEB05	195864	6.5 mm	H6	45 mm	60 mm	5 mm	700 N

WOOD FIXING EYE SCREW

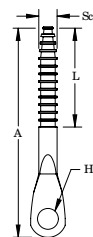

Material: Steel
Finish: Electrogalvanized

Part Number	Article Number	Screw Diameter	Screw Length	Hole Size	Length
SLEBWS	195858	H6	32 mm	8.8 mm	60 mm

EYE SCREW

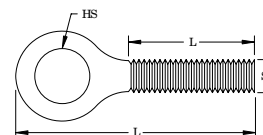

Material: Steel
Finish: Electrogalvanized

Part Number	Article Number	Screw Diameter	Screw Length	Hole Size	Length
SLEBM6	195854	M6	20 mm	7.2 mm	37.5 mm
SLEBM8	195856	M8	25 mm	8.5 mm	50.0 mm

Do not use light fixture eyelet as a lifting device.

nVent CADDY Speed Link Universal Support System

NVENT CADDY SPEED LINK ACCESSORIES

MC/AC CABLE CLIP

- Spring steel cable attachment
- Allows for electrical cable to be attached to nVent CADDY Speed Link wire rope

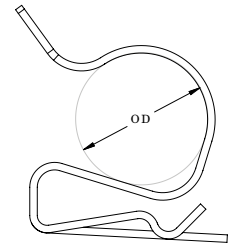
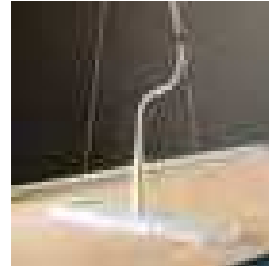
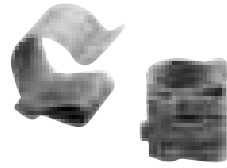

Material: Spring Steel
Finish: nVent CADDY Armour

Part Number	Article Number	Wire Rope Diameter	Outer Diameter
SL1214	195860	1.5 – 3.0 mm	11.8 – 14.2 mm
SL1518	195861	1.5 – 3.0 mm	12.7 – 18.2 mm

08. nVent CADDY Pyramid





WHY BUY NVENT CADDY PYRAMID

FOR ENGINEERS AND CONSULTANTS:

CHALLENGE:

- Properly support heavy loads
- Minimize the chance of point loading or abrading the roof membrane
- Ensure chemical compatibility with anything you place on the roof membrane

PYRAMID SOLUTION:

- Pyramid offers a broad portfolio compatible with most roof surfaces, including single-ply, bituminous, metal and spray foam
- Pyramid provides excellent load distribution with some of the industry's best load ratings
- Pyramid minimizes point loading and roof abrasion
- Pyramid is UV stable, corrosion resistant, and durable over an extensive temperature range

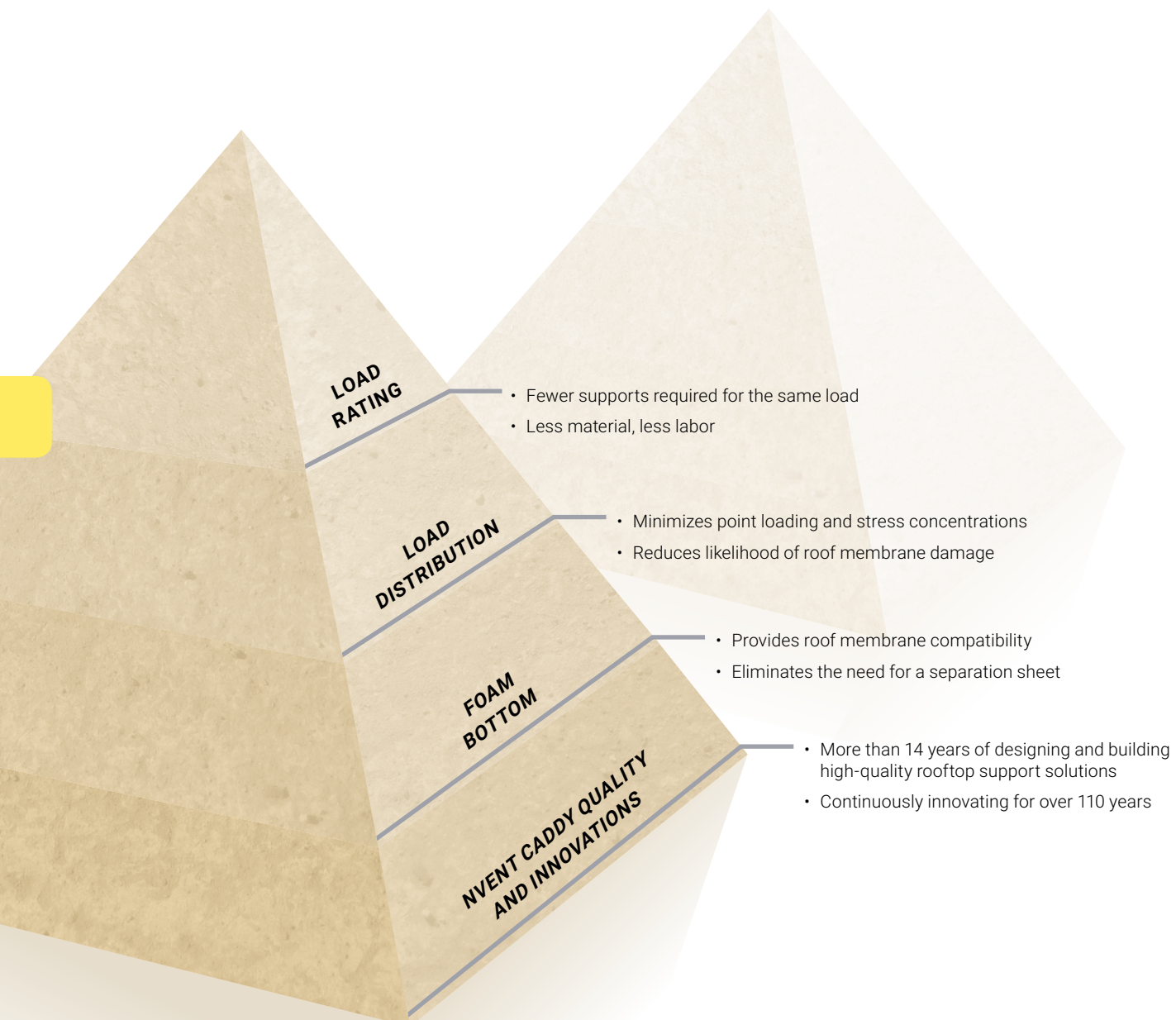



WHY BUY PYRAMID

FOR BUILDING OWNERS:

CHALLENGE:

- Roofs not only protect some of the most valuable assets, they often represent a significant cost to replace and maintain
- Substandard materials and methods can increase the chance of roof damage
- Increasingly, roofs are seen as prime real estate and are being utilized for equipment placement, alternative energy systems, and as green space

PYRAMID SOLUTION:

- Pyramid is extremely roof compatible
- Pyramid is designed to minimize the chance of damage to roofs
- Pyramid is fast and easy to install, minimizing costs
- Pyramid provides an aesthetically pleasing, flexible engineered solution designed to meet the challenges of densely populated roofs



WHY BUY PYRAMID

FOR CONTRACTORS AND INSTALLERS:

CHALLENGE:

- Meet the project scope and stay within budget
- Provide a high quality installation
- Need a fast and easy to install solution
- Adapt to a broad range of applications and roof materials

PYRAMID SOLUTION:

- Pyramid is designed to get installers on and off the roof quickly
- Pyramid creates an aesthetically pleasing, high quality solution
- Pyramid offers a broad portfolio of solutions that simplify material management

Pyramid rooftop supports are a surface mounted solution for supporting electrical and mechanical applications on a variety of roof surfaces.

They offer superior load capacity and dramatically reduce installation time by replacing slow, heavy and labor-intensive methods for support of pipe, conduit, duct, cable tray and equipment.

Unlike wood blocks, Pyramid supports are specifically designed for rooftop applications, incorporating unique materials and finishes that protect roof membranes and provide superior corrosion protection.

Hot-dip galvanized for superior corrosion protection

UV stabilized for long lasting performance



Foam bottom offers low abrasion interface for better roof membrane protection

Compatible with roof surfaces including single ply, bituminous, metal and spray foam

nVent CADDY Pyramid Rooftop Systems

NVENT CADDY PYRAMID ST STRUT-BASED SUPPORTS

NVENT CADDY PYRAMID ST FIXED STRUT SUPPORT

- Provides superior support for pipe, conduit, duct, cable tray and equipment
- Foam bottom offers low abrasion interface for better roof membrane protection
- Compatible with roof surfaces including single ply, bituminous, metal and spray foam
- Provides superior load distribution, even with varying rooftop surfaces
- Ready to use out of the box, saving installation time and labor
- Multiple sizes and load ratings offer the ability to tailor the solution to the application
- Easy to transport to the roof
- Hot-dip galvanized and UV stabilized for long lasting performance



Material: Polyethylene, Polypropylene, Steel
 Finish: Hot-Dip Galvanized
 Temperature: -45 to 65 °C
 Static Load Safety Factor: 3:1

Part Number	Article Number	Length 1	Length 2	Height	Width	Surface Area	Unit Weight	Static Load	Certifications
PSF6C	360463	152 mm	203.0 mm	122 mm	152 mm	26,452 mm ²	0.5 kg	1,334 N	
PSF10C	360464	254 mm	317.5 mm	122 mm	203 mm	59,355 mm ²	1.0 kg	4,450 N	ITB
PSF10D	360465	254 mm	317.5 mm	163 mm	203 mm	59,355 mm ²	1.5 kg	4,450 N	ITB
PSF16C	360466	406 mm	483.0 mm	122 mm	203 mm	91,613 mm ²	1.5 kg	6,670 N	ITB
PSF16D	360467	406 mm	483.0 mm	163 mm	203 mm	91,613 mm ²	2.0 kg	6,670 N	ITB

Static load at 73.1 kPa (10.6 psi) roof loading.
 Contact project or roofing engineer for maximum allowable load on individual project roof system.

nVent CADDY Pyramid Rooftop Systems

NVENT CADDY PYRAMID ST STRUT-BASED SUPPORTS

NVENT CADDY PYRAMID ST ADJUSTABLE STRUT SUPPORT

- Height adjustability provides effective navigation of pipe, conduit, duct and cable tray around obstructions
- Foam bottom offers low abrasion interface for better roof membrane protection
- Compatible with roof surfaces including single ply, bituminous, metal and spray foam
- Provides superior load distribution, even with varying rooftop surfaces
- Ready to use out of the box, saving installation time and labor
- Multiple sizes and load ratings offer the ability to tailor the solution to the application
- Hot-dip galvanized and UV stabilized for long lasting performance

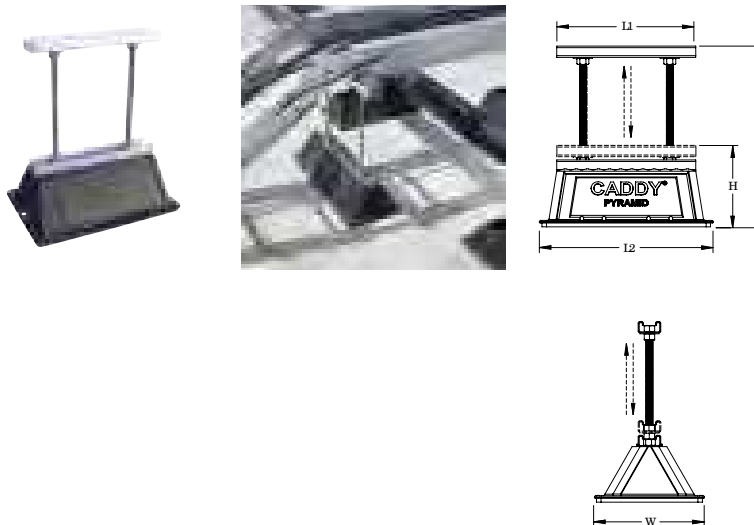

Material: Polyethylene, Polypropylene, Steel
 Finish: Hot-Dip Galvanized
 Temperature: -45 to 65 °C
 Static Load Safety Factor: 3:1

Part Number	Article Number	Length 1	Length 2	Height	Width	Surface Area	Unit Weight	Static Load
PSA10CH13	360468	254 mm	317.5 mm	152 – 330 mm	203 mm	59,355 mm ²	2 kg	4,450 N
PSA16AH18	360469	406 mm	483.0 mm	178 – 457 mm	203 mm	91,613 mm ²	3 kg	6,670 N

NVENT CADDY PYRAMID ST BRIDGE ASSEMBLY

- Ideal for supporting multiple pipe runs, cable tray and air handling units
- Foam bottom offers low abrasion interface for better roof membrane protection
- Compatible with roof surfaces including single ply, bituminous, metal and spray foam
- Provides superior load distribution, even with varying rooftop surfaces
- Ready to use out of the box, saving installation time and labor
- Multiple sizes and load ratings offer the ability to tailor the solution to the application
- Hot-dip galvanized and UV stabilized for long lasting performance

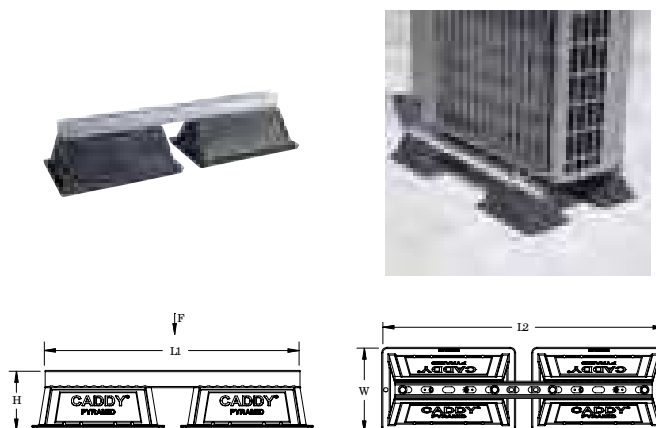

Material: Polyethylene, Polypropylene, Steel
 Finish: Hot-Dip Galvanized
 Temperature: -45 to 65 °C
 Static Load Safety Factor: 3:1

Part Number	Article Number	Length 1	Length 2	Height	Width	Surface Area	Unit Weight	Static Load
PSB24A	360475	610 mm	673 mm	142 mm	203 mm	118,709 mm ²	2 kg	8,900 N
PSB30A	360476	762 mm	826 mm	142 mm	203 mm	118,709 mm ²	3 kg	8,900 N
PSB36A	360477	914 mm	978 mm	142 mm	203 mm	118,709 mm ²	4 kg	8,900 N
PSB42A	360478	1,067 mm	1,143 mm	142 mm	203 mm	183,225 mm ²	4 kg	13,340 N
PSB48A	360479	1,219 mm	1,283 mm	142 mm	203 mm	183,225 mm ²	4 kg	13,340 N
PSB60A	360480	1,524 mm	1,588 mm	142 mm	203 mm	183,225 mm ²	6 kg	13,340 N

Static loads are assumed to be uniformly distributed.

nVent CADDY Pyramid Rooftop Systems

NVENT CADDY PYRAMID RL ROLLER-BASED SUPPORTS

NVENT CADDY PYRAMID RL FIXED ROLLER SUPPORT

- Roller-based support designed specifically for rooftop applications
- Roller capability allows longitudinal movement of pipe, resulting from thermal expansion or contraction
- Polymeric rollers ensure corrosion free rotation
- Foam bottom offers low abrasion interface for better roof membrane protection
- Compatible with roof surfaces including single ply, bituminous, metal and spray foam
- Ready to use out of the box, saving installation time and labor
- Hot-dip galvanized and UV stabilized for long lasting performance

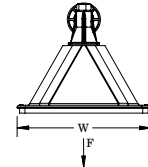
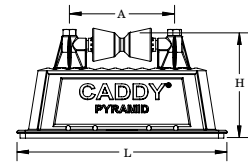

Material: Polyethylene, Polypropylene, Steel
 Finish: Hot-Dip Galvanized
 Temperature: -45 to 65 °C
 Static Load Safety Factor: 3:1

Part Number	Article Number	Pipe Size	NB/DN	Height	Length	Width	A	Surface Area	Unit Weight	Static Load
PRF2	360470	2" Max	50 Max	147 mm	203 mm	152 mm	114 mm	26,452 mm ²	0.5 kg	440 N
PRF6	360472	6" Max	150 Max	159 mm	483 mm	203 mm	260 mm	91,613 mm ²	1.5 kg	2,670 N

nVent CADDY Pyramid Rooftop Systems

NVENT CADDY PYRAMID RL ROLLER-BASED SUPPORTS

NVENT CADDY PYRAMID RL ADJUSTABLE ROLLER SUPPORT

- Height-adjustable roller-based support designed specifically for rooftop applications
- Height adjustability allows for effective navigation of pipe around obstructions
- Polymeric rollers ensure corrosion free rotation
- Foam bottom offers low abrasion interface for better roof membrane protection
- Compatible with roof surfaces including single ply, bituminous, metal and spray foam
- Ready to use out of the box, saving installation time and labor
- Hot-dip galvanized and UV stabilized for long lasting performance

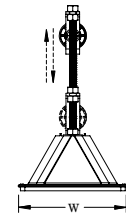
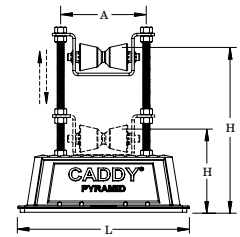

Material: Polyethylene, Polypropylene, Steel
 Finish: Hot-Dip Galvanized
 Temperature: -45 to 65 °C
 Static Load Safety Factor: 3:1

Part Number	Article Number	Pipe Size	NB/DN	Height	Length	Width	A	Surface Area	Unit Weight	Static Load
PRA6H16	360474	6" Max	150 Max	165 – 406 mm	483 mm	203 mm	260 mm	91,613 mm ²	2 kg	2,670 N

RETAINER STRAP

- Prevents pipe from being dislodged from roller supports
- Innovative twist-lock design allows for easy installation without requiring hardware removal

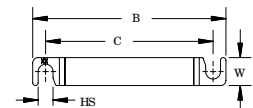
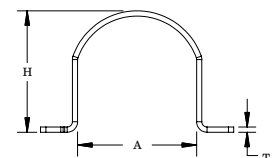

Material: Steel
 Finish: Hot-Dip Galvanized

Part Number	Article Number	Pipe Size	NB/DN	Hole Size	Height	Width	Thickness	A	B	C
PRS6	360483	6" Max	150 Max	13.5 mm	188 mm	25 mm	4.8 mm	213.4 mm	285.4 mm	260 mm

Retainer straps must be used with roller supports that have an equivalent pipe size.

nVent CADDY Pyramid Rooftop Systems

NVENT CADDY PYRAMID H-FRAME

NVENT CADDY PYRAMID H-FRAME POST BASE

- Foam or rubber bottom offers low abrasion interface for better roof membrane protection
- Compatible with roof surfaces including single ply, bituminous, metal and spray foam
- Provides superior load distribution, even with varying rooftop surfaces
- Rubber rooftop interface ideal for solar panel array installations
- Mounting hardware pre-installed in bases
- Hot-dip galvanized and UV stabilized for long lasting performance
- Accepts standard strut channels

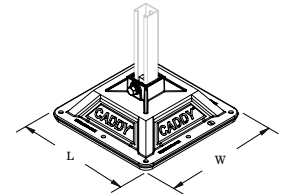
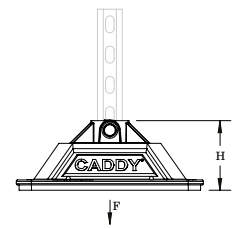

Material: Steel, Polypropylene, Polyethylene
 Finish: Hot-Dip Galvanized
 Temperature: -34 to 54 °C
 Static Load Safety Factor: 3:1

Part Number	Article Number	Rooftop Interface	Strut Type	Height	Length	Width	Surface Area	Unit Weight	Static Load
PHB	360422	Foam	A (41 x 41 mm)	117 mm	314 mm	314 mm	0.09 m ²	1.8 kg	3,335 N
PHBR	360423	Rubber	A (41 x 41 mm)	118 mm	314 mm	314 mm	0.10 m ²	2.0 kg	3,335 N

NVENT CADDY PYRAMID H-FRAME KIT

- Foam or rubber bottom offers low abrasion interface for better roof membrane protection
- Compatible with roof surfaces including single ply, bituminous, metal and spray foam
- Provides superior load distribution, even with varying rooftop surfaces
- Rubber rooftop interface ideal for solar panel array installations
- Kit includes 2 post bases with pre-installed mounting hardware, 6 bolts, 6 strut nuts, and 2 L-brackets to complete H-frame
- Hot-dip galvanized and UV stabilized for long lasting performance
- Accepts standard strut channels

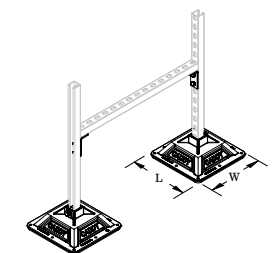
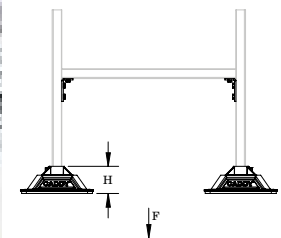
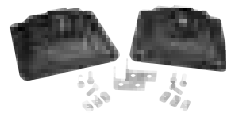

Material: Polypropylene, Polyethylene
 Temperature: -34 to 54 °C
 Static Load Safety Factor: 3:1

Part Number	Article Number	Rooftop Interface	Strut Type	Height	Length	Width	Surface Area	Static Load	Certifications
PHK	360420	Foam	A (41 x 41 mm)	117 mm	314 mm	314 mm	0.18 m ²	6,670 N	ITB
PHKR	360421	Rubber	A (41 x 41 mm)	118 mm	314 mm	314 mm	0.20 m ²	6,670 N	ITB

Static load represents 750 lb (3,335 N) per post base. The end user must select and evaluate the strut framing to ensure the assembled H-frame can properly support the applied load.

nVent CADDY Pyramid Rooftop Systems

NVENT CADDY PYRAMID H-FRAME

NVENT CADDY PYRAMID H-FRAME HARDWARE KIT

- Kit includes six bolts, six strut nuts, and two L-brackets to build custom multi-tier H-frame assemblies

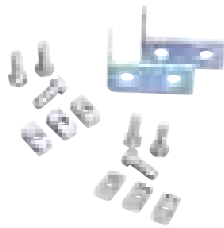

Material: Steel
Finish: Hot-Dip Galvanized

Part Number	Article Number	Screw Diameter
HFRMHDW	360424	M12

NVENT CADDY PYRAMID EQUIPMENT SUPPORT KIT, 4 POST BASE

- Kit includes post-base assemblies, frame and equipment-support clamps
- Assembles and adjusts to size and height in minutes by one person with one tool
- Innovative crossbar and equipment-support clamps enable quick assembly
- Integral foam pad provides gentle interface for all roof types
- Hot-dip galvanized and UV stabilized for long lasting performance
- Assembled support can be lifted as one unit and easily relocated

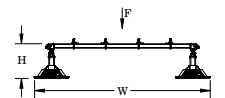
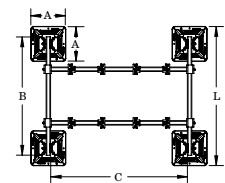
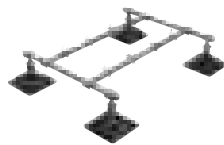

Material: Steel, Polypropylene, Polyethylene
Finish: Hot-Dip Galvanized
Temperature: -34 to 54 °C
Height: 305 – 457 mm
Length: 1,257 mm

Part Number	Article Number	Post Base	Square Tube	Cross Bar Assembly	Width	Surface Area	Unit Weight	Ultimate Static Load	Certifications
PEK4B	360426	314 mm x 4 pc	1,067 mm x 2 pc	1,232 mm x 2 pc	1,588 mm	0.36 m ²	36 kg	4,980 N	ITB

Static load must be stable and uniformly distributed across frame.

nVent CADDY Pyramid Rooftop Systems

NVENT CADDY PYRAMID EQUIPMENT SUPPORTS

NVENT CADDY PYRAMID EQUIPMENT SUPPORT KIT, 6 POST BASE

- Kit includes post-base assemblies, frame and equipment-support clamps
- Assembles and adjusts to size and height in minutes by one person with one tool
- Innovative crossbar and equipment-support clamps enable quick assembly
- Integral foam pad provides gentle interface for all roof types
- Hot-dip galvanized and UV stabilized for long lasting performance
- Assembled support can be lifted as one unit and easily relocated

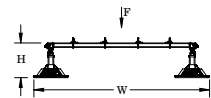
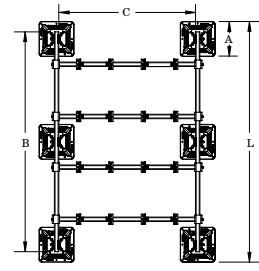

Material: Steel, Polypropylene, Polyethylene
 Finish: Hot-Dip Galvanized
 Temperature: -34 to 54 °C
 Height: 305 – 457 mm
 Length: 2,172 mm

Part Number	Article Number	Post Base	Square Tube	Cross Bar Assembly	Width	Surface Area	Unit Weight	Ultimate Static Load	Certifications
PEK6B	360427	314 mm x 6 pc	1,981 mm x 2 pc	1,232 mm x 4 pc	1,588 mm	0.56 m ²	56 kg	9,960 N	ITB

Static load must be stable and uniformly distributed across frame.

NVENT CADDY PYRAMID EQUIPMENT SUPPORT FRAME EXTENSION KIT

- Allows creation of custom equipment support lengths by attaching the nVent CADDY Pyramid Extension Kit in series to a nVent CADDY Pyramid Equipment Support Kit
- Kit includes two post-base assemblies, frame and equipment-support clamps for easy attachment to a nVent CADDY Pyramid Equipment Support Kit
- Square tube and cross bars provide superior load and deflection capabilities over standard strut profiles
- Assembles and adjusts to size and height in minutes by one person with one tool
- Innovative crossbar and equipment-support clamps enable quick assembly
- Integral foam pad provides gentle interface for all roof types
- Hot-dip galvanized and UV stabilized for long lasting performance

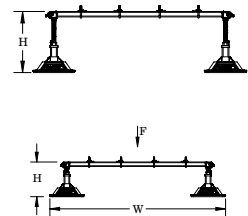
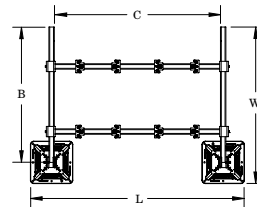

Material: Steel, Polypropylene, Polyethylene
 Finish: Hot-Dip Galvanized
 Temperature: -34 to 54 °C
 Height: 305 – 457 mm
 Length: 1,588 mm

Part Number	Article Number	Post Base	Square Tube	Cross Bar Assembly	Width	Surface Area	Unit Weight	Ultimate Static Load
PEKEF	360493	305 mm x 2 pc	1,067 mm x 2 pc	1,232 mm x 2 pc	1,257 mm	0.18 m ²	28 kg	4,980 N

Static load must be stable and uniformly distributed across frame. nVent CADDY Pyramid Equipment Support Frame Extension must be used in conjunction with a nVent CADDY Pyramid Equipment Support Kit.

nVent CADDY Pyramid Rooftop Systems

NVENT CADDY PYRAMID EQUIPMENT SUPPORTS

NVENT CADDY PYRAMID EQUIPMENT SUPPORT HEIGHT EXTENSION

- Increases the height between the equipment support frame and roof deck
- Inserts directly into nVent CADDY Pyramid Equipment Support Bases

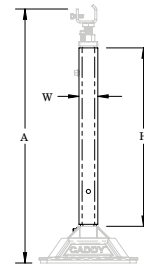

Material: Steel
Finish: Hot-Dip Galvanized

Part Number	Article Number	Height	Width	A
PEH31	360494	568 mm	60 mm	762 – 914 mm

NVENT CADDY PYRAMID EQUIPMENT SUPPORT POST BASE

- Ideal for use with strut channel type A and U-shaped brackets to create custom equipment supports
- Height adjustable
- Foam bottom offers low abrasion interface for better roof membrane protection
- Compatible with roof surfaces including single ply, bituminous, metal and spray foam
- Provides superior load distribution, even with varying rooftop surfaces
- Hot-dip galvanized and UV stabilized for long lasting performance

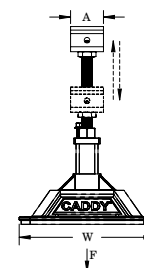
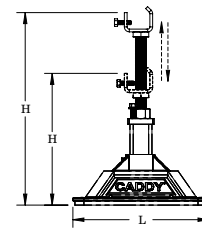

Material: Steel, Polypropylene, Polyethylene
Finish: Hot-Dip Galvanized
Temperature: -34 to 54 °C
Static Load Safety Factor: 3:1

Part Number	Article Number	Height	Length	Width	A	Surface Area	Unit Weight	Static Load
PEB	360425	305 – 457 mm	314 mm	314 mm	76 mm	0.09 m ²	4 kg	3,340 N

The end user must select and evaluate the strut framing to ensure the custom assembled equipment support can properly support the applied load.

nVent CADDY Pyramid Rooftop Systems

NVENT CADDY PYRAMID EQUIPMENT SUPPORTS

NVENT CADDY PYRAMID EQUIPMENT SUPPORT CLAMP

- Ideal for use with strut channel type A and square tube to create custom equipment supports
- Slotted design offers fast and easy installation

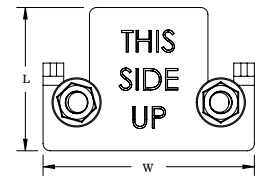
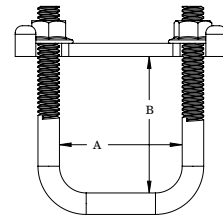

Material: Steel
Finish: Hot-Dip Galvanized

Part Number	Article Number	Strut Type	Length	Width	A	B
PEC	360428	A (41 x 41 mm)	64 mm	95 mm	53 mm	58 mm

nVent CADDY Pyramid Rooftop Systems

NVENT CADDY PYRAMID EZ RUBBER-BASED SUPPORTS

NVENT CADDY PYRAMID EZ RUBBER-BASED ADJUSTABLE SUPPORT

- Quick height adjustment accommodates for uneven roofs or sloped condensate lines
- No tools or fasteners needed; fast snap-on installation
- Design sheds water and helps reduce pipe corrosion
- Roof-friendly; made of UV-stabilized EPDM material

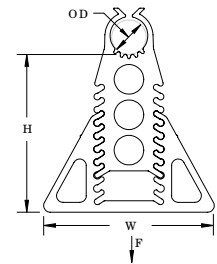
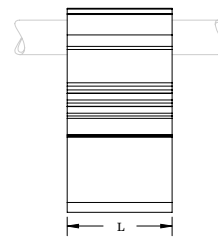
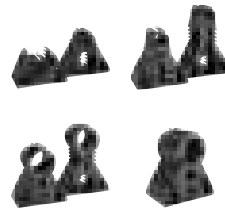

Material: EPDM-SBR Rubber

Part Number	Article Number	NB/DN	Outer Diameter	Height	Length	Width	Unit Weight	Ultimate Static Load	Certifications
RPSE1H24	182365	25	33 mm	45 – 102 mm	102 mm	152 mm	0.91 kg	756 N	ITB
RPSE1H57	182370	25	33 mm	127 – 178 mm	102 mm	152 mm	1.30 kg	756 N	
RPSE2H46	182375	50	60 mm	102 – 152 mm	102 mm	152 mm	1.50 kg	1,112 N	ITB
RPSE4H46	182380	100	114 mm	100 – 150 mm	102 mm	240 mm	2.33 kg	3,920 N	ITB

Ultimate load at 1/4" (6.35 mm) deflection. Contact project or roofing engineer for maximum allowable load on individual project roof system.

NVENT CADDY PYRAMID UNIVERSAL SUPPORT

- Captive stainless steel nuts allow for custom attachment methods to the support base including easy attachment of stainless steel strut, threaded rod or other project-specific hardware
- Foam bottom offers low abrasion interface for better roof membrane protection
- Compatible with roof surfaces including single ply, bituminous, metal and spray foam
- Provides superior load distribution, even with varying rooftop surfaces
- Multiple sizes and load ratings offer the ability to tailor the solution to the application
- Base is manufactured from UV-stabilized thermoplastic material

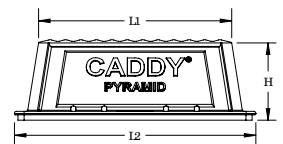
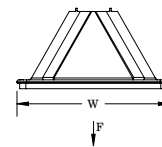
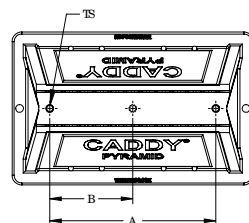

Material: Polyethylene, Polypropylene, Stainless Steel 18-8 (EN 1.4305)
 Temperature: -45 to 65 °C
 Static Load Safety Factor: 3:1

Part Number	Article Number	L1	L2	H	W	TS	Number of Holes	A	B	Surface Area	Static Load (F)
PBU6M	360495	139.7	203.0	101.6	152	M10	3	114.3	57.2	26,452	1,330
PBU10M	360496	254.0	317.5	101.6	203	M10	2	218.4	–	59,355	4,450
PBU16M	360497	406.0	483.0	101.6	203	M10	2	165.1	–	91,613	6,670

nVent CADDY Pyramid Rooftop Systems

NVENT CADDY PYRAMID TOOL-FREE SUPPORTS

NVENT CADDY PYRAMID TOOL-FREE PIPE SUPPORT KIT

- Push-in clamps install without the need for additional tools or strut clamps
- Ready to use out of the box, saving installation time and labor
- Plastic clamps and base will not corrode pipe
- Clamps come in two different sizes to fit project needs
- Base includes multiple holes to accommodate a variety of clamp sizes and configurations
- Additional clamps can be purchased separately for additional pipe runs
- Foam bottom offers low abrasion interface for better roof membrane protection
- Provides superior load distribution, even with varying rooftop surfaces
- Compatible with roof surfaces including single ply, bituminous, metal and spray foam
- Multiple sizes and load ratings offer the ability to tailor the solution to the application
- Easy to transport to the roof

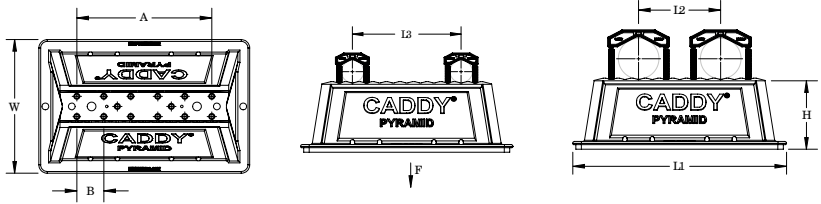

Part Number	Number of Clamps Included		Maximum Clamp Capacity	
	PTF1C	PTF2C	PTF1C	PTF2C
PTF6	1	1	3	1
PTF10	-	2	5	2
PTF16	-	2	7	3

Material: Polyethylene, Polypropylene, Nylon
 Temperature: -45 to 65 °C
 Static Load Safety Factor: 3:1

Part Number	Article Number	L1	L2	L3	W	H	A	B	Surface Area	Static Load (F)
PTF6	360460	203.2		81.3	152	101.6	121.9	40.6	26,452	1,330
PTF10	360461	317.5	121.9	162.6	203	101.6	203.2	40.6	59,355	4,450
PTF16	360462	482.6	203.2	243.8	203	101.6	284.5	40.6	91,613	6,670

Length 2 represents maximum pipe center to pipe center using PTF2C clamps.
 Length 3 represents maximum pipe center to pipe center using PTF1C clamps.

NVENT CADDY PYRAMID TOOL-FREE PIPE CLAMP

- Push-in clamps install without the need for additional tools or strut clamps
- Clamps come in two different sizes to fit project needs
- Plastic clamps and base will not corrode pipe

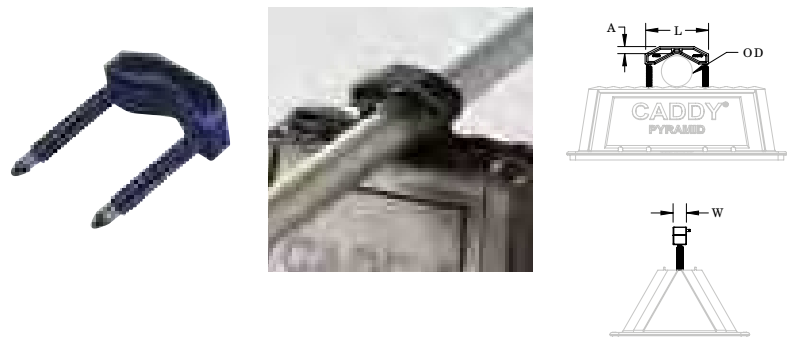

Material: Nylon
 Temperature: -45 to 65 °C

Part Number	Article Number	Outer Diameter	Length	Width	A	Unit Weight
PTF1C	360484	12.7 – 22.4 mm	40.6 mm	19.1 mm	9.5 mm	0.01 kg
PTF2C	360485	21.3 – 60.3 mm	81.3 mm	19.1 mm	9.5 mm	0.02 kg

nVent CADDY Pyramid Rooftop Systems

NVENT CADDY PYRAMID TOOL-FREE SUPPORTS

NVENT CADDY PYRAMID TOOL-FREE CABLE TRAY SUPPORT KIT

- Push-in pins install without the need for additional tools
- Plastic pins and base will not corrode
- Pins and mounting holes accommodate most perforated cable tray
- Ready to use out of the box, saving installation time and labor
- Additional pins can be purchased separately
- Foam bottom offers low abrasion interface for better roof membrane protection
- Provides superior load distribution, even with varying rooftop surfaces
- Compatible with roof surfaces including single ply, bituminous, metal and spray foam
- Multiple sizes and load ratings offer the ability to tailor the solution to the application
- Easy to transport to the roof



Material: Polyethylene, Polypropylene, Nylon
 Temperature: -45 to 65 °C
 Static Load Safety Factor: 3:1

Part Number	Article Number	Length	Width	Height	Surface Area	Unit Weight	Static Load
PTF6P	360518	203.2 mm	152 mm	101.6 mm	26,452 mm ²	0.3 kg	1,330 N
PTF10P	360519	317.5 mm	203 mm	101.6 mm	59,355 mm ²	0.5 kg	4,450 N
PTF16P	360522	482.6 mm	203 mm	101.6 mm	91,613 mm ²	1.0 kg	6,670 N

NVENT CADDY PYRAMID TOOL-FREE CABLE TRAY PIN

- Push-in pins install without the need for additional tools
- Plastic pins and base will not corrode
- Pins and mounting holes accommodate most perforated cable tray



Material: Nylon
 Temperature: -45 to 65 °C

Part Number	Article Number	Diameter	Length
PTFP	360521	20 mm	41.9 mm

nVent CADDY Pyramid Rooftop Systems

NVENT CADDY PYRAMID 25 PIPE AND CONDUIT SUPPORT, PLASTIC

- Simple solution for supporting small pipes or conduit runs
- Lightweight plastic construction
- UV resistant, designed and tested for outdoor use
- No tools or fasteners needed for installation
- Rounded edges to help protect the roof membrane

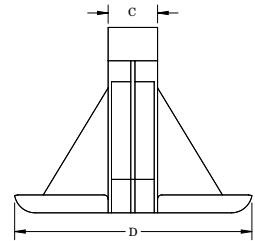
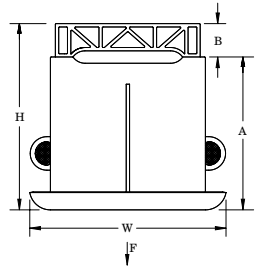

Material: Acrylonitrile Butadiene Styrene

Part Number	Article Number	Pipe Size	Height mm	Depth mm	Width mm	A mm	B mm	C mm	Static Load	Certifications
PPRPS25H4	182450	1/2" x 3, 3/4" x 2, 1" x 1	112.7	144.5	119	92.1	20.6	25.4	110 N	ITB

09. Mechanical



Mechanical

CLEVIS HANGERS

401 CLEVIS HANGER

- Recommended for the suspension of stationary non-insulated pipe lines
- Flared edges help prevent sharp surfaces from coming into contact with the pipe (1/2" to 2" pipe sizes)
- Clevis bottom pivots to allow pipe to be fed from either direction

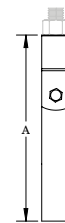
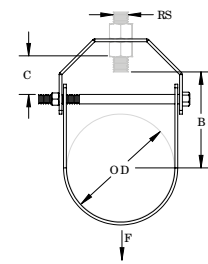

Material: Steel
Finish: Electrogalvanized, Pregalvanized

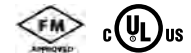

Part Number	Article Number	Pipe Size	NB/DN	Outer Diameter	Rod Size	A	B	C	Static Load	Certifications
4010050EG	179398	1/2"	15	21.0 mm	M10	59 mm	29.0 mm	9.0 mm	2,700 N	cULus, ITB
4010075EG	179399	3/4"	20	27.0 mm	M10	64 mm	32.0 mm	9.0 mm	2,700 N	cULus, FM, ITB
4010100EG	179420	1"	25	34.0 mm	M10	71 mm	35.0 mm	9.0 mm	2,700 N	cULus, FM, ITB
4010125EG	179421	1 1/4"	32	43.0 mm	M10	80 mm	40.0 mm	9.0 mm	2,700 N	cULus, FM, ITB
4010150EG	179422	1 1/2"	40	48.0 mm	M10	94 mm	53.0 mm	17.0 mm	2,700 N	cULus, FM, ITB
4010200EG	179423	2"	50	60.0 mm	M10	110 mm	63.0 mm	22.0 mm	2,700 N	cULus, FM, ITB
4010250EG	179424	2 1/2"	65	76.0 mm	M12	134 mm	78.0 mm	25.0 mm	5,000 N	cULus, FM, ITB
4010300EG	179425	3"	80	89.0 mm	M12	154 mm	90.0 mm	29.0 mm	5,000 N	cULus, FM, ITB
4010350EG	179521	3 1/2"	90	101.6 mm	M12	172 mm	101.0 mm	34.0 mm	5,000 N	cULus, FM
4010400EG	179426	4"	100	114.0 mm	M16	189 mm	111.0 mm	35.0 mm	5,000 N	cULus, FM, ITB
4010500EG	179427	5"	125	140.0 mm	M16	231 mm	130.0 mm	41.0 mm	6,400 N	cULus, FM, ITB
4010600EG	179428	6"	150	165.0 mm	M20	268 mm	153.0 mm	48.0 mm	8,600 N	cULus, FM, ITB
4010800EG	179429	8"	200	219.0 mm	M20	356 mm	204.0 mm	80.0 mm	8,900 N	cULus, FM, ITB
4011000EG	179430	10"	250	273.0 mm	M20	419 mm	230.0 mm	66.0 mm	16,000 N	ITB
4011200EG	179431	12"	300	324.0 mm	M20	473 mm	258.0 mm	78.0 mm	17,000 N	ITB

A shield is recommended for insulated pipe applications to effectively distribute the load.

Mechanical

CLEVIS HANGERS

410 CLEVIS HANGER, LIGHT DUTY

- Recommended for the suspension of stationary non-insulated pipe lines
- Also commonly used for the suspension of insulated pipe lines
- Flared edges help prevent sharp surfaces from coming into contact with the pipe (1/2" to 8" pipe sizes)
- Clevis bottom pivots to allow pipe to be fed from either direction

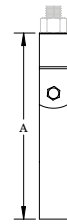
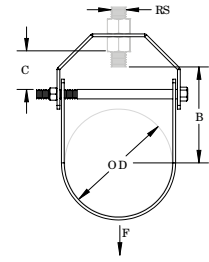

Material: Steel
Finish: Electrogalvanized, Pregalvanized



Part Number	Article Number	Pipe Size	NB/DN	Outer Diameter	Rod Size	A	B	C	Static Load	Certifications
4100100EG	179400	1"	25	34 mm	M10	71 mm	35 mm	9 mm	1,100 N	cULus, ITB
4100125EG	179401	1 1/4"	32	43 mm	M10	80 mm	40 mm	9 mm	1,100 N	cULus, ITB
4100150EG	179402	1 1/2"	40	48 mm	M10	94 mm	53 mm	17 mm	1,100 N	cULus, ITB
4100200EG	179403	2"	50	60 mm	M10	110 mm	63 mm	22 mm	1,100 N	cULus, ITB
4100250EG	179404	2 1/2"	65	73 mm	M12	134 mm	78 mm	25 mm	1,550 N	cULus, ITB
4100300EG	179405	3"	80	89 mm	M12	154 mm	90 mm	29 mm	1,550 N	cULus, ITB
4100400EG	179406	4"	100	114 mm	M16	189 mm	111 mm	35 mm	2,200 N	cULus, ITB
4100500EG	179407	5"	125	140 mm	M16	231 mm	130 mm	41 mm	2,670 N	cULus, ITB
4100600EG	179408	6"	150	165 mm	M20	268 mm	153 mm	48 mm	3,550 N	cULus, ITB
4100800EG	179409	8"	200	219 mm	M20	340 mm	193 mm	62 mm	5,300 N	cULus, ITB

Mechanical

LOOP HANGERS

115 STANDARD DUTY LOOP HANGER

- Flared edges help prevent any sharp surfaces from coming into contact with the pipe (1/2" to 4" sizes)
- Retained insert nut helps ensure the loop hanger and insert nut stay together
- Recommended for the suspension of stationary non-insulated pipe lines
- Manufactured to use the minimum rod size permitted by NFPA® for fire sprinkler piping
- Conforms with Federal Specification WW-H-171 (Type 10), Manufacturers Standardization Society (MSS) SP-58 (Type 10)
- Minimum load capacity is compliant to EN 12845

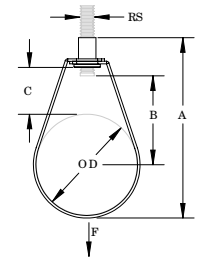

Material: Steel
Finish: Pregalvanized



Part Number	Article Number	Pipe Size	NB/DN	Outer Diameter	Rod Size	A	B	C	Static Load	Certifications
115M0050EG	597860	1/2"	15	21.3 mm	M10	71.0 mm	28.6 mm	25.4 mm	1,335 N	cULus, ITB, VdS
115M0075EG	597870	3/4"	20	26.9 mm	M10	75.9 mm	30.2 mm	23.9 mm	1,335 N	cULus, FM, ITB, VdS
115M0100EG	597880	1"	25	33.7 mm	M10	82.5 mm	34.9 mm	24.1 mm	1,335 N	cULus, FM, ITB, VdS
115M0125EG	597890	1 1/4"	32	42.4 mm	M10	90.6 mm	38.1 mm	24.1 mm	1,335 N	cULus, FM, ITB, VdS
115M0150EG	597900	1 1/2"	40	48.3 mm	M10	96.7 mm	41.3 mm	24.1 mm	1,335 N	cULus, FM, ITB, VdS
115M0200EG	597910	2"	50	60.3 mm	M10	108.6 mm	47.6 mm	23.9 mm	1,335 N	cULus, FM, ITB, VdS
115M0250EG	597920	2 1/2"	65	76.0 mm	M10	150.8 mm	87.3 mm	50.8 mm	2,340 N	cULus, FM, ITB, VdS
115M0300EG	597930	3"	80	89.0 mm	M10	166.3 mm	88.2 mm	49.7 mm	2,340 N	cULus, FM, ITB, VdS
115M0400EG	597940	4"	100	114.0 mm	M10	192.5 mm	100.9 mm	48.9 mm	2,890 N	cULus, FM, ITB, VdS
115M0500EG	597950	5"	125	140.0 mm	M12	232.7 mm	120.0 mm	57.1 mm	4,450 N	cULus, FM, ITB, VdS
115M0600EG	597960	6"	150	165.0 mm	M12	286.6 mm	160.4 mm	84.1 mm	4,450 N	cULus, FM, ITB, VdS
115M0800EG	597970	8"	200	219.0 mm	M12	327.1 mm	175.1 mm	73.4 mm	4,450 N	cULus, FM, ITB

Mechanical

LOOP HANGERS

DROP-IN LOOP HANGER

- Next generation loop hanger revolutionizes the installation of pipe
- Once on the guide arm, the weight of the pipe opens the self-closing latch and effortlessly guides the pipe into place
- Integrated rubber sleeve is designed to provide additional grip when adjusting hanger height and reduce hanger rotation around the barrel nut
- Eliminates the need to disassemble the hanger during installation
- Allows prefabrication of complex assemblies with fittings, sprinkler heads, and branch lines that previously could not be installed in one piece
- Designed to reduce overhead work for a safer, less strenuous installation
- Flared edges help prevent sharp surfaces from coming into contact with the pipe
- Retained insert nut helps ensure the loop hanger and insert nut stay together
- Recommended for the suspension of stationary non-insulated pipe lines
- Manufactured to use the minimum rod size permitted by NFPA® for fire sprinkler piping
- Conforms with Federal Specification WW-H-171 (Type 10), Manufacturers Standardization Society (MSS) SP-58 (Type 10)

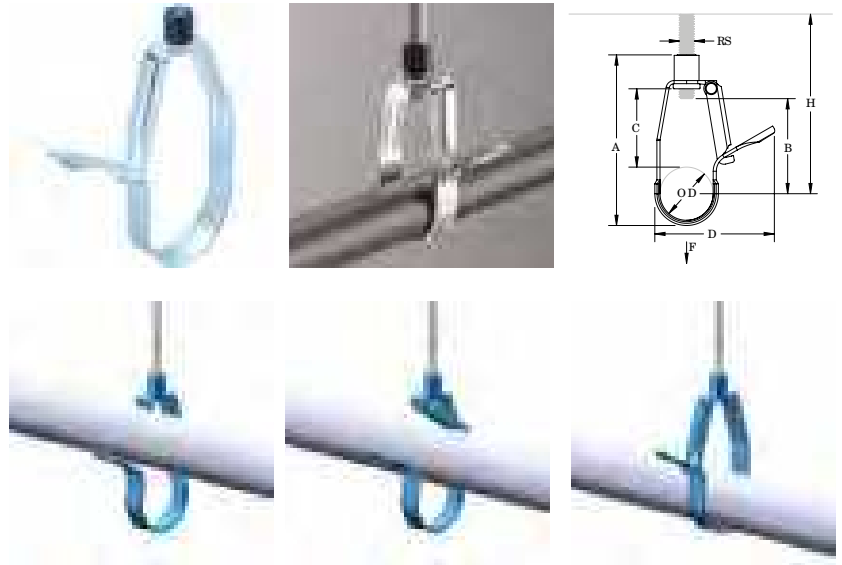

Material: Steel
Finish: Electrogalvanized



Part Number	Article Number	Pipe Size	NB/DN	Outer Diameter	Rod Size	A mm	B mm	C mm	D mm	Installation Height	Static Load
DHM0100EG	598984	1"	25	33.7 mm	M10	111.1	65.1	55.6	75.5	88.9 mm Min	1,334 N
DHM0125EG	598985	1 1/4"	32	42.4 mm	M10	127.0	79.4	63.5	90.7	104.8 mm Min	1,334 N
DHM0150EG	598994	1 1/2"	40	48.3 mm	M10	139.7	87.3	69.9	100.4	111.1 mm Min	1,334 N
DHM0200EG	598995	2"	50	60.3 mm	M10	163.5	104.8	82.6	125.0	133.4 mm Min	1,334 N

Installation Height represents the clearance distance needed from the loop hanger guide arm to structure to allow for installation of pipe.

Mechanical

LOOP HANGERS

FCS HEIGHT ADJUSTABLE LOOP HANGER

- Recommended for the suspension of stationary non-insulated fire sprinkler pipe
- Redesigned strap and cup nut minimize friction for easier adjustment up and down the threaded rod (1/2" to 4" sizes)
- Formed tips on the upper strap simplify disassembly and reassembly of the hanger
- Rolled edges on the strap help to guide the pipe through, limiting binding and damage to metal or plastic pipe
- Package includes all necessary hardware for installation

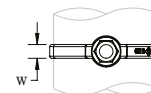
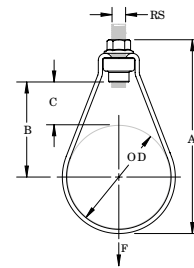

Material: Steel
Finish: Electrogalvanized



Part Number	Article Number	Pipe Size	NB/DN	OD	RS	W	A	B	C	F
FCS0075M8	597962	3/4	20	27	M8	10	74	31	17	1,600
FCS0075M10	597968	3/4	20	27	M10	10	76	31	17	1,600
FCS0100M8	597963	1	25	34	M8	10	85	36	19	1,600
FCS0100M10	597969	1	25	34	M10	10	87	36	19	1,600
FCS0125M8	597964	1 1/4	32	43	M8	10	89	36	15	1,600
FCS0125M10	597971	1 1/4	32	43	M10	10	91	36	15	1,600
FCS0150M8	597965	1 1/2	40	48	M8	10	97	41	17	1,600
FCS0150M10	597972	1 1/2	40	48	M10	10	99	41	17	1,600
FCS0200M8	597966	2	50	60	M8	10	112	50	20	1,600
FCS0200M10	597973	2	50	60	M10	10	114	50	20	1,600
FCS0250M10	597974	2 1/2	65	76	M10	10	142	68	30	2,300
FCS0300M10	597975	3	80	89	M10	10	164	83	39	2,300
FCS0400M10	597976	4	100	114	M10	10	206	112	55	2,300
FCS0500M12	597977	5	125	140	M12	15	227	114	44	2,900
FCS0600M12	597978	6	150	165	M12	15	272	146	63	4,000
FCS0800M16	597979	8	200	219	M16	25	349	184	75	4,000
FCS1000M20	597981	10	250	273	M20	25	480	279	143	6,500

Mechanical

LOOP HANGERS

FIXING SET FOR FCS LOOP HANGER

- Replacement cup nut for FCS loop hanger



Material: Steel
Finish: Electrogalvanized

Part Number	Article Number	Rod Size	Pipe Size	NB/DN
FCSNUT8	598151	M8	1/2" – 2"	15 – 50
FCSNUT10S	598152	M10	3/4" – 2"	20 – 50
FCSNUT10L	598153	M10	2 1/2" – 4"	65 – 100
FCSNUT12	598154	M12	5" – 6"	125 – 150
FCSNUT16	598155	M16	8"	200
FCSNUT20	598156	M20	10"	250

HEX FLANGE NUT

- ISO@ 4161, CL. 8
- DIN 6923, CL. 8



Material: Steel
Finish: Electrogalvanized

Part Number	Article Number	Rod Size	Wrench Size
NUTFLM10	597983	M10	15 mm
NUTFLM8	597982	M8	13 mm

Mechanical

LOOP HANGERS

115 SURGE RESTRAINT

- Accommodates multiple sizes of 115 standard duty loop hangers
- Complies with NFPA® 13 standard by restricting the upward surge movement of activated fire sprinkler systems
- Grips the loop hanger, not the nut, allowing fine tuning for height adjustment
- Easily installs by hand before or after pipe is positioned in hanger

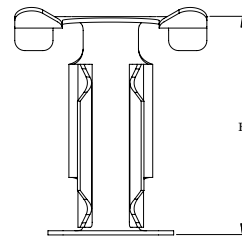
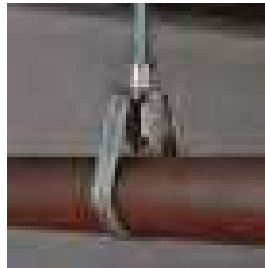

Material: Spring Steel
Finish: nVent CADDY Armour



Part Number	Article Number	Pipe Size	Height
SR6	597865	1/2" – 2"	33 mm

DH SURGE RESTRAINT

- Designed to work directly with the Drop-in Loop Hanger series
- Complies with NFPA® 13 standard by restricting the upward surge movement of activated fire sprinkler systems
- Easily installs by hand before or after pipe is positioned in hanger

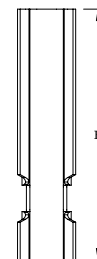

Material: Steel
Finish: Electrogalvanized



Part Number	Article Number	Pipe Size	Height
SR0100EG	597866	1"	70.4 mm
SR0125EG	597867	1 1/4"	78.2 mm
SR0150EG	597868	1 1/2"	83.8 mm
SR0200EG	597869	2"	97.8 mm

Mechanical

RUBBER LINED PIPE CLAMPS

NVENT CADDY MACROFIX INSULATED M8

- Return-lip on the hanger prevents the rubber from detaching, eliminating rework during installation
- Plastic washer prevents screws from falling out during installation
- Combo head bolt works with slotted, hex, or Phillips drivers
- Longer ears position the screw farther from the hanger, improving tool clearance when the screw is tightened
- Screw length has been optimized to accommodate an increased pipe range, reducing inventory
- Category II noise reduction according to DIN EN ISO 3822-1
- Compliant for sound insulation design according to DIN 4109
- Reaction-to-fire classification is "E" in compliance with DIN EN 13501-1:2010-01

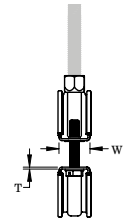
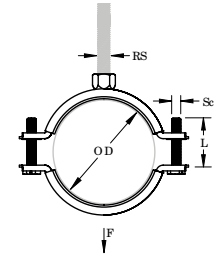

Material: EPDM-SBR Rubber, Steel
 Finish: Electrogalvanized
 Temperature: -50 to 110 °C



Part Number	Article Number	Outer Diameter	Pipe Size	NB/DN	Rod Size	Width	Thickness	Screw Diameter	Screw Length	Static Load
MFE015	586201	11 – 15 mm	1/4"	8	M8	20 mm	1.00 mm	M6	17 mm	1,000 N
MFE019	586202	15 – 19 mm	3/8"	10	M8	20 mm	1.00 mm	M6	17 mm	1,000 N
MFE025	586203	19 – 25 mm	1/2"	15	M8	20 mm	1.00 mm	M6	22 mm	1,000 N
MFE031	586204	25 – 31 mm	3/4"	20	M8	20 mm	1.00 mm	M6	22 mm	1,000 N
MFE037	586205	31 – 37 mm	1"	25	M8	20 mm	1.00 mm	M6	22 mm	1,000 N
MFE044	586206	37 – 44 mm	1 1/4"	32	M8	20 mm	1.00 mm	M6	27 mm	1,000 N
MFE050	586207	44 – 50 mm	1 1/2"	40	M8	20 mm	1.25 mm	M6	27 mm	1,500 N
MFE058	586208	50 – 58 mm			M8	20 mm	1.25 mm	M6	27 mm	1,500 N
MFE068	586209	58 – 68 mm	2"	50	M8	20 mm	1.25 mm	M6	32 mm	1,500 N

Mechanical

RUBBER LINED PIPE CLAMPS

nVENT CADDY MACROFIX INSULATED M8/M10

- Return-lip on the hanger prevents the rubber from detaching, eliminating rework during installation
- Plastic washer prevents screws from falling out during installation
- Combo head bolt works with slotted, hex, or Phillips drivers
- Longer ears position the screw farther from the hanger, improving tool clearance when the screw is tightened
- Combination nut can be attached to M8 or M10 threaded rod, simplifying material handling
- Screw length has been optimized to accommodate an increased pipe range, reducing inventory
- Category II noise reduction according to DIN EN ISO 3822-1
- Compliant for sound insulation design according to DIN 4109
- Reaction-to-fire classification is "E" in compliance with DIN EN 13501-1:2010-01

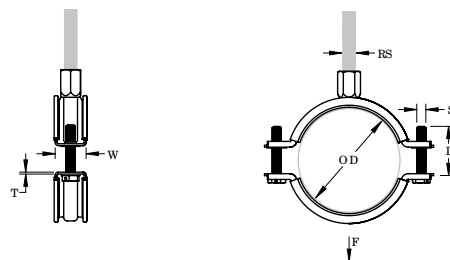

Material: Steel, EPDM-SBR Rubber
 Finish: Electrogalvanized
 Color: Black
 Temperature: -50 to 110 °C



Part Number	Article Number	Outer Diameter	Pipe Size	NB/DN	Rod Size	Width	Thickness	Screw Diameter	Screw Length	Static Load
MFD015	586001	11 – 15 mm	1/4"	8	M8, M10	20 mm	1.00 mm	M6	17 mm	1,000 N
MFD019	586002	15 – 19 mm	3/8"	10	M8, M10	20 mm	1.00 mm	M6	17 mm	1,000 N
MFD025	586003	19 – 25 mm	1/2"	15	M8, M10	20 mm	1.00 mm	M6	22 mm	1,000 N
MFD031	586004	25 – 31 mm	3/4"	20	M8, M10	20 mm	1.00 mm	M6	22 mm	1,000 N
MFD037	586005	31 – 37 mm	1"	25	M8, M10	20 mm	1.00 mm	M6	22 mm	1,000 N
MFD044	586006	37 – 44 mm	1 1/4"	32	M8, M10	20 mm	1.00 mm	M6	27 mm	1,000 N
MFD050	586007	44 – 50 mm	1 1/2"	40	M8, M10	20 mm	1.25 mm	M6	27 mm	1,500 N
MFD058	586008	50 – 58 mm			M8, M10	20 mm	1.25 mm	M6	27 mm	1,500 N
MFD068	586009	58 – 68 mm	2"	50	M8, M10	20 mm	1.25 mm	M6	32 mm	1,500 N
MFD078	586010	68 – 78 mm	2 1/2"	65	M8, M10	23 mm	1.50 mm	M6	32 mm	2,000 N
MFD088	586011	78 – 88 mm			M8, M10	23 mm	1.50 mm	M6	32 mm	2,000 N
MFD098	586012	88 – 98 mm	3"	80	M8, M10	23 mm	1.75 mm	M6	37 mm	2,500 N
MFD108	586013	98 – 108 mm	3 1/2"	90	M8, M10	23 mm	1.75 mm	M6	37 mm	2,500 N
MFD118	586014	108 – 118 mm	4"	100	M8, M10	23 mm	1.75 mm	M6	37 mm	2,500 N
MFD128	586015	118 – 128 mm			M8, M10	23 mm	2.00 mm	M6	37 mm	3,000 N
MFD138	586016	128 – 138 mm			M8, M10	23 mm	2.00 mm	M6	37 mm	3,000 N
MFD148	586017	138 – 148 mm	5"	125	M8, M10	25 mm	2.00 mm	M6	37 mm	3,200 N
MFD160	586018	150 – 160 mm			M8, M10	25 mm	2.00 mm	M6	37 mm	3,200 N
MFD170	586019	160 – 170 mm	6"	150	M8, M10	25 mm	2.00 mm	M6	37 mm	3,200 N
MFD200	586020	190 – 200 mm			M8, M10	27 mm	2.25 mm	M6	37 mm	3,600 N
MFD215	586021	205 – 215 mm			M8, M10	27 mm	2.25 mm	M6	37 mm	3,600 N
MFD225	586022	215 – 225 mm	8"	200	M8, M10	27 mm	2.25 mm	M6	37 mm	3,600 N
MFD250	586023	239 – 250 mm			M8, M10	30 mm	2.50 mm	M6	37 mm	4,000 N
MFD275	586024	265 – 275 mm	10"	250	M8, M10	30 mm	2.50 mm	M6	37 mm	4,000 N
MFD319	586025	309 – 319 mm			M8, M10	30 mm	2.50 mm	M6	37 mm	4,000 N

Mechanical

RUBBER LINED PIPE CLAMPS

nVENT CADDY MACROFIX INSULATED M8/M10, STAINLESS STEEL

- Return-lip on the hanger prevents the rubber from detaching, eliminating rework during installation
- Plastic washer prevents screws from falling out during installation
- Combo head bolt works with slotted, hex, or Phillips drivers
- Longer ears position the screw farther from the hanger, improving tool clearance when the screw is tightened
- Combination nut can be attached to M8 or M10 threaded rod, simplifying material handling
- Screw length has been optimized to accommodate an increased pipe range, reducing inventory
- Category II noise reduction according to DIN EN ISO 3822-1
- Compliant for sound insulation design according to DIN 4109
- Reaction-to-fire classification is "E" in compliance with DIN EN 13501-1:2010-01

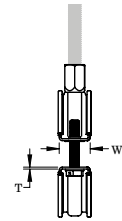
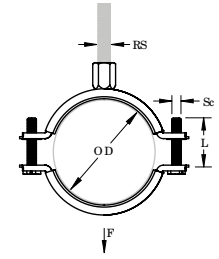

Material: EPDM-SBR Rubber, Stainless Steel 316L (EN 1.4404)
 Finish: Electropolished
 Color: Black
 Temperature: -50 to 110 °C



Part Number	Article Number	Outer Diameter	Pipe Size	NB/DN	Rod Size	Width	Thickness	Screw Diameter	Screw Length	Static Load
MFD015S6	586301	11 – 15 mm	1/4"	8	M8, M10	20 mm	1.00 mm	M6	17 mm	1,000 N
MFD019S6	586302	15 – 19 mm	3/8"	10	M8, M10	20 mm	1.00 mm	M6	17 mm	1,000 N
MFD025S6	586303	19 – 25 mm	1/2"	15	M8, M10	20 mm	1.00 mm	M6	22 mm	1,000 N
MFD031S6	586304	25 – 31 mm	3/4"	20	M8, M10	20 mm	1.00 mm	M6	22 mm	1,000 N
MFD037S6	586305	31 – 37 mm	1"	25	M8, M10	20 mm	1.00 mm	M6	22 mm	1,000 N
MFD044S6	586306	37 – 44 mm	1 1/4"	32	M8, M10	20 mm	1.00 mm	M6	27 mm	1,000 N
MFD050S6	586307	44 – 50 mm	1 1/2"	40	M8, M10	20 mm	1.25 mm	M6	27 mm	1,300 N
MFD058S6	586308	50 – 58 mm			M8, M10	20 mm	1.25 mm	M6	27 mm	1,300 N
MFD068S6	586309	58 – 68 mm	2"	50	M8, M10	20 mm	1.25 mm	M6	32 mm	1,300 N
MFD078S6	586310	68 – 78 mm	2 1/2"	65	M8, M10	23 mm	1.50 mm	M6	32 mm	1,500 N
MFD088S6	586311	78 – 88 mm			M8, M10	23 mm	1.50 mm	M6	32 mm	1,500 N
MFD098S6	586312	88 – 98 mm	3"	80	M8, M10	23 mm	1.75 mm	M6	37 mm	1,800 N
MFD108S6	586313	98 – 108 mm	3 1/2"	90	M8, M10	23 mm	1.75 mm	M6	37 mm	1,800 N
MFD118S6	586314	108 – 118 mm	4"	100	M8, M10	23 mm	1.75 mm	M6	37 mm	2,200 N
MFD128S6	586315	118 – 128 mm			M8, M10	23 mm	2.00 mm	M6	37 mm	2,200 N
MFD138S6	586316	128 – 138 mm			M8, M10	23 mm	2.00 mm	M6	37 mm	2,200 N
MFD148S6	586317	138 – 148 mm	5"	125	M8, M10	25 mm	2.00 mm	M6	37 mm	2,600 N
MFD160S6	586318	150 – 160 mm			M8, M10	25 mm	2.00 mm	M6	37 mm	2,600 N
MFD170S6	586319	160 – 170 mm	6"		M8, M10	25 mm	2.00 mm	M6	37 mm	2,600 N
MFD200S6	586320	190 – 200 mm			M8, M10	27 mm	2.25 mm	M6	37 mm	3,600 N
MFD215S6	586321	205 – 215 mm			M8, M10	27 mm	2.25 mm	M6	37 mm	3,600 N
MFD225S6	586322	215 – 225 mm	8"	200	M8, M10	27 mm	2.25 mm	M6	37 mm	3,600 N

Mechanical

RUBBER LINED PIPE CLAMPS

NVENT CADDY MACROFIX PLUS

- Includes easy closing mechanism
- Age-resistant lining
- Combo head bolt works with slotted, hex, or Phillips drivers
- Category II noise reduction according to DIN EN ISO 3822-1
- Compliant for sound insulation design according to DIN 4109
- Reaction-to-fire classification is "E" in compliance with DIN EN 13501-1:2010-01

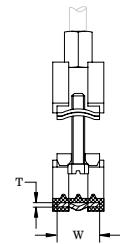
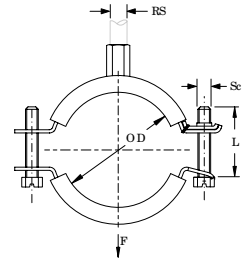

Material: Steel, EPDM-SBR Rubber
 Finish: Electrogalvanized
 Color: Black
 Temperature: -50 to 110 °C

Part Number	Article Number	Outer Diameter	Pipe Size	NB/DN	Rod Size	Width	Thickness	Screw Diameter	Screw Length	Static Load
MPD014	400078	12 – 14 mm	1/4"	8	M8, M10	20 mm	1.5 mm	M6	20 mm	1,000 N
MPD019	400079	15 – 19 mm	3/8"	10	M8, M10	20 mm	1.5 mm	M6	20 mm	1,000 N
MPD023	400080	21 – 23 mm	1/2"	15	M8, M10	20 mm	1.5 mm	M6	20 mm	1,000 N
MPD028	400081	26 – 28 mm	3/4"	20	M8, M10	20 mm	1.5 mm	M6	20 mm	1,000 N
MPD035	400082	32 – 35 mm	1"	25	M8, M10	20 mm	1.5 mm	M6	20 mm	1,000 N
MPD043	400083	40 – 43 mm	1 1/4"	32	M8, M10	20 mm	1.5 mm	M6	20 mm	1,000 N
MPD049	400084	44 – 49 mm	1 1/2"	40	M8, M10	20 mm	2.0 mm	M6	20 mm	1,300 N
MPD056	400085	50 – 56 mm			M8, M10	20 mm	2.0 mm	M6	25 mm	1,300 N
MPD061	400086	57 – 61 mm	2"	50	M8, M10	20 mm	2.0 mm	M6	25 mm	1,300 N
MPD067	400087	63 – 67 mm			M8, M10	20 mm	2.0 mm	M6	25 mm	1,300 N
MPD073	400088	70 – 73 mm			M8, M10	20 mm	2.0 mm	M6	25 mm	1,300 N
MPD080	400089	74 – 80 mm	2 1/2"	65	M8, M10	20 mm	2.0 mm	M6	25 mm	1,300 N
MPD091	400090	83 – 91 mm	3"	80	M8, M10	20 mm	2.0 mm	M6	25 mm	1,300 N
MPD106	400091	101 – 106 mm			M8, M10	23 mm	2.5 mm	M6	25 mm	2,200 N
MPD114	400092	108 – 114 mm	4"	100	M8, M10	23 mm	2.5 mm	M8	25 mm	2,200 N
MPD116	400093	115 – 116 mm			M8, M10	23 mm	2.5 mm	M8	25 mm	2,200 N
MPD127	400094	123 – 127 mm			M8, M10	23 mm	2.5 mm	M8	25 mm	2,200 N
MPD135	400095	131 – 135 mm			M8, M10	23 mm	2.5 mm	M8	25 mm	2,200 N
MPD139	400096	136 – 139 mm	5"	125	M8, M10	23 mm	2.5 mm	M8	25 mm	2,200 N
MPD144	400097	140 – 144 mm			M8, M10	23 mm	2.5 mm	M8	30 mm	2,200 N
MPD163	400098	159 – 163 mm			M8, M10	23 mm	2.5 mm	M8	30 mm	2,200 N
MPD169	400099	165 – 169 mm	6"	150	M8, M10	23 mm	2.5 mm	M8	30 mm	2,200 N
MPD200	400100	193 – 200 mm			M8, M10	25 mm	3.0 mm	M8	30 mm	2,200 N
MPD212	400101	210 – 212 mm			M8, M10	25 mm	3.0 mm	M8	30 mm	2,200 N

Lining is EPDM rubber.

Mechanical

RUBBER LINED PIPE CLAMPS

NVENT CADDY MACROFIX PLUS KOMBI WITH COMBINATION NUT

- Includes easy closing mechanism
- Age-resistant lining
- Category II noise reduction according to DIN EN ISO 3822-1
- Compliant for sound insulation design according to DIN 4109
- Reaction-to-fire classification is "E" in compliance with DIN EN 13501-1:2010-01

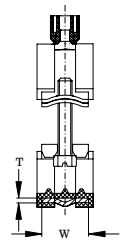
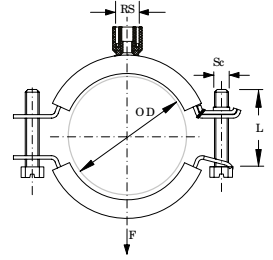

Rod Size: M8, M10, 1/2"
 Color: Black
 Temperature: -50 to 110 °C
 Material: Steel; EPDM-SBR Rubber
 Finish: Electrogalvanized

Part Number	Article Number	Outer Diameter	Pipe Size	NB/DN	Width	Thickness	Screw Diameter	Screw Length	Static Load	Certifications
MPK028	401903	26 – 28 mm	3/4"	20	20 mm	1.5 mm	M6	20 mm	1,000 N	ITB
MPK035	401904	32 – 35 mm	1"	25	20 mm	1.5 mm	M6	20 mm	1,000 N	ITB
MPK043	401905	40 – 43 mm	1 1/4"	32	20 mm	1.5 mm	M6	20 mm	1,000 N	ITB
MPK049	401906	44 – 49 mm			20 mm	2.0 mm	M6	20 mm	1,300 N	ITB
MPK056	401907	48 – 52 mm	1 1/2"	40	20 mm	2.0 mm	M6	25 mm	1,300 N	ITB
MPK061	401908	57 – 61 mm	2"	50	20 mm	2.0 mm	M6	25 mm	1,300 N	ITB
MPK080	401911	74 – 80 mm	2 1/2"	65	20 mm	2.0 mm	M6	25 mm	1,300 N	ITB
MPK091	401912	83 – 91 mm	3"	80	20 mm	2.0 mm	M6	25 mm	1,300 N	ITB
MPK114	401914	108 – 114 mm	4"	100	23 mm	2.5 mm	M8	25 mm	2,200 N	ITB
MPK139	401918	136 – 139 mm	5"	125	23 mm	2.5 mm	M8	25 mm	2,200 N	ITB
MPK163	401920	159 – 163 mm			23 mm	2.5 mm	M8	30 mm	2,200 N	ITB
MPK169	401921	165 – 169 mm	6"	150	23 mm	2.5 mm	M8	30 mm	2,200 N	ITB
MPK200	401922	193 – 200 mm			25 mm	3.0 mm	M8	30 mm	2,500 N	ITB

Lining is EPDM rubber.

Mechanical

RUBBER LINED PIPE CLAMPS

NVENT CADDY MACROFIX PLUS LF LOW-FRICTION

- Includes easy closing mechanism
- Age resistant lining designed specifically for plastic pipe applications
- Low-friction properties allow for expansion, contraction and easy sliding of pipe
- Conforms with Manufacturers Standardization Society (MSS) SP-58 (Type 12)
- Category II noise reduction according to DIN EN ISO 3822-1
- Compliant for sound insulation design according to DIN 4109

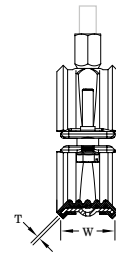
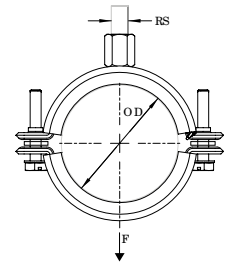

Material: Steel, EPDM-SBR Rubber
 Finish: Electrogalvanized
 Color: Green
 Temperature: -50 to 110 °C

Part Number	Article Number	Outer Diameter	Pipe Size	NB/DN	Plastic Pipe Size	Rod Size	Width	Thickness	Static Load
MPL016	595035	16 mm	3/8"	10		M8, M10	30 mm	1.5 mm	1,125 N
MPL020	595036	20 mm	1/2"	15	20 mm	M8, M10	30 mm	1.5 mm	1,125 N
MPL025	595037	25 mm	3/4"	20	25 mm	M8, M10	30 mm	1.5 mm	1,125 N
MPL032	595038	32 mm	1"	25	32 mm	M8, M10	30 mm	1.5 mm	1,125 N
MPL040	595039	40 mm	1 1/4"	32	40 mm	M8, M10	30 mm	1.5 mm	1,125 N
MPL050	595040	50 mm	1 1/2"	40	50 mm	M8, M10	30 mm	2.0 mm	1,725 N
MPL063	595042	63 mm	2"	50	63 mm	M8, M10	30 mm	2.0 mm	1,725 N
MPL075	595043	75 mm	2 1/2"	65	75 mm	M8, M10	30 mm	2.0 mm	1,725 N
MPL090	595044	90 mm	3"	80	90 mm	M8, M10	30 mm	2.0 mm	1,725 N
MPL110	595045	110 mm	4"	100	100 mm	M8, M10	30 mm	2.5 mm	2,000 N
MPL125	595046	125 mm			110 mm	M8, M10	30 mm	2.5 mm	2,000 N
MPL140	595047	140 mm	5"	125		M8, M10	30 mm	2.5 mm	2,000 N
MPL160	595048	160 mm			160 mm	M8, M10	30 mm	2.5 mm	2,000 N

Lining is EPDM rubber.

Mechanical

RUBBER LINED PIPE CLAMPS

NVENT CADDY SUPERFIX 243 M8

- Includes easy closing mechanism
- Combo head bolt works with slotted, hex, or Phillips drivers
- Category II noise reduction according to DIN EN ISO 3822-1
- Compliant for sound insulation design according to DIN 4109
- Reaction-to-fire classification is "E" in compliance with DIN EN 13501-1:2010-01

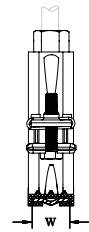
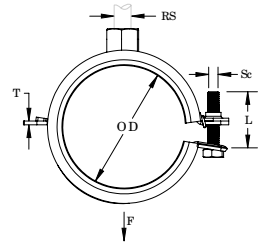

Material: Steel, EPDM-SBR Rubber
 Finish: Electrogalvanized
 Color: Black
 Temperature: -50 to 110 °C

Part Number	Article Number	Outer Diameter	Pipe Size	NB/DN	Rod Size	Width	Thickness	Screw Diameter	Screw Length	Static Load
SXE014	400055	12 – 14 mm	1/4"	8	M8	20 mm	1.5 mm	M6	25 mm	1,000 N
SXE019	400056	15 – 19 mm	3/8"	10	M8	20 mm	1.5 mm	M6	25 mm	1,000 N
SXE023	400057	21 – 23 mm	1/2"	15	M8	20 mm	1.5 mm	M6	25 mm	1,000 N
SXE028	400058	26 – 28 mm	3/4"	20	M8	20 mm	1.5 mm	M6	25 mm	1,000 N
SXE035	400059	32 – 35 mm	1"	25	M8	20 mm	1.5 mm	M6	30 mm	1,000 N
SXE043	400060	40 – 43 mm	1 1/4"	32	M8	20 mm	1.5 mm	M6	30 mm	1,000 N
SXE049	400061	44 – 49 mm			M8	20 mm	1.5 mm	M6	30 mm	1,300 N
SXE052	400062	48 – 52 mm	1 1/2"	40	M8	20 mm	1.5 mm	M6	30 mm	1,300 N
SXE058	589310	54 – 58 mm			M8	20 mm	2.0 mm	M6	30 mm	1,300 N
SXE061	589320	57 – 61 mm	2"	50	M8	20 mm	2.0 mm	M6	30 mm	1,300 N

Lining is EPDM rubber.

Mechanical

RUBBER LINED PIPE CLAMPS

NVENT CADDY SUPERFIX 243 M8/M10

- Includes easy closing mechanism
- Combo head bolt works with slotted, hex, or Phillips drivers
- Category II noise reduction according to DIN EN ISO 3822-1
- Compliant for sound insulation design according to DIN 4109
- Reaction-to-fire classification is "E" in compliance with DIN EN 13501-1:2010-01

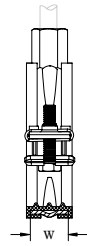
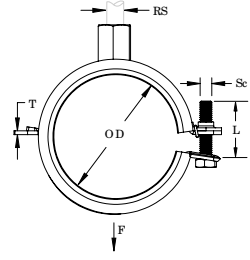

Material: Steel, EPDM-SBR Rubber
 Finish: Electrogalvanized
 Color: Black
 Temperature: -50 to 110 °C

Part Number	Article Number	Outer Diameter	Pipe Size	NB/DN	Rod Size	Width	Thickness	Screw Diameter	Screw Length	Static Load
SXD014	400063	12 – 14 mm	1/4"	8	M8, M10	20 mm	1.5 mm	M6	25 mm	1,000 N
SXD019	400064	15 – 19 mm	3/8"	10	M8, M10	20 mm	1.5 mm	M6	25 mm	1,000 N
SXD023	400065	21 – 23 mm	1/2"	15	M8, M10	20 mm	1.5 mm	M6	25 mm	1,000 N
SXD028	400066	26 – 28 mm	3/4"	20	M8, M10	20 mm	1.5 mm	M6	25 mm	1,000 N
SXD035	400067	32 – 35 mm	1"	25	M8, M10	20 mm	1.5 mm	M6	30 mm	1,000 N
SXD043	400068	40 – 43 mm	1 1/4"	32	M8, M10	20 mm	1.5 mm	M6	30 mm	1,000 N
SXD049	400069	44 – 49 mm			M8, M10	20 mm	1.5 mm	M6	30 mm	1,300 N
SXD052	400070	48 – 52 mm	1 1/2"	40	M8, M10	20 mm	1.5 mm	M6	30 mm	1,300 N
SXD058	589350	54 – 58 mm			M8, M10	20 mm	2.0 mm	M6	30 mm	1,300 N
SXD061	400071	57 – 61 mm	2"	50	M8, M10	20 mm	2.0 mm	M6	30 mm	1,300 N
SXD067	400072	63 – 67 mm			M8, M10	20 mm	2.0 mm	M6	30 mm	1,300 N
SXD073	400073	70 – 73 mm			M8, M10	20 mm	2.0 mm	M6	35 mm	1,300 N
SXD080	400074	74 – 80 mm	2 1/2"	65	M8, M10	20 mm	2.0 mm	M6	35 mm	1,300 N
SXD091	400075	83 – 91 mm	3"	80	M8, M10	20 mm	2.0 mm	M6	35 mm	1,300 N
SXD106	400076	101 – 106 mm			M8, M10	23 mm	2.5 mm	M6	35 mm	2,200 N
SXD114	400077	108 – 114 mm	4"	100	M8, M10	23 mm	2.5 mm	M6	40 mm	2,200 N

Lining is EPDM rubber.

Mechanical

RUBBER LINED PIPE CLAMPS

HD HEAVY DUTY PIPE CLAMP

- Fillet welded connector nut has flats to accommodate spanners
- Easy open flange for pipe sizes less than 4"
- Adaptor bushings to female 1/2", 3/4", 1" available
- Category II noise reduction according to DIN EN ISO 3822-1
- Compliant for sound insulation design according to DIN 4109
- Reaction-to-fire classification is "E" in compliance with DIN EN 13501-1:2010-01

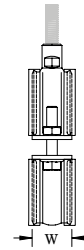
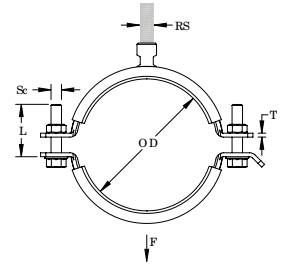

Material: Steel, EPDM-SBR Rubber
 Finish: Electrogalvanized
 Temperature: -50 to 110 °C
 Color: Black

Part Number	Article Number	Outer Diameter	Pipe Size	NB/DN	Rod Size	Width	Thickness	Screw Diameter	Screw Length	Static Load
HDI018	577033	14 – 18 mm	3/8"	10	M8, M10	30 mm	2.5 mm	M6	30 mm	2,000 N
HDI023	577034	19 – 23 mm	1/2"	15	M8, M10	30 mm	2.5 mm	M6	30 mm	2,000 N
HDI028	577035	24 – 28 mm	3/4"	20	M8, M10	30 mm	2.5 mm	M6	30 mm	2,000 N
HDI033	577036	29 – 33 mm	1"	25	M8, M10	30 mm	2.5 mm	M6	30 mm	2,000 N
HDI037	577037	33 – 37 mm			M8, M10	30 mm	2.5 mm	M6	30 mm	2,000 N
HDI045	577038	40 – 45 mm	1 1/4"	32	M8, M10	30 mm	2.5 mm	M6	30 mm	2,000 N
HDI052	577039	47 – 52 mm	1 1/2"	40	M8, M10	30 mm	2.5 mm	M6	30 mm	2,000 N
HDI058	577040	53 – 58 mm			M8, M10	30 mm	2.5 mm	M6	30 mm	2,000 N
HDI065	577041	60 – 65 mm	2"	50	M8, M10	30 mm	2.5 mm	M8	40 mm	2,000 N
HDI078	577043	73 – 78 mm	2 1/2"	65	M10, M12	30 mm	3.0 mm	M8	40 mm	3,500 N
HDI093	577045	88 – 93 mm	3"	80	M10, M12	30 mm	3.0 mm	M8	40 mm	3,500 N
HDI116	577048	108 – 116 mm	4"	100	M10, M12	30 mm	3.0 mm	M8	40 mm	3,500 N
HDI129	577050	124 – 129 mm			M10, M12	40 mm	4.0 mm	M8	40 mm	3,500 N
HDI137	577051	131 – 137 mm			M12, M16	40 mm	4.0 mm	M10	40 mm	3,500 N
HDI145	577052	138 – 145 mm	5"	125	M12, M16	40 mm	4.0 mm	M10	40 mm	5,000 N
HDI154	577053	148 – 154 mm			M12, M16	40 mm	4.0 mm	M10	40 mm	5,000 N
HDI162	577054	156 – 162 mm			M12, M16	40 mm	4.0 mm	M10	40 mm	5,000 N
HDI171	577055	165 – 171 mm	6"	150	M12, M16	40 mm	4.0 mm	M10	40 mm	5,000 N
HDI203	577058	196 – 203 mm			M12, M16	40 mm	4.0 mm	M10	40 mm	5,000 N
HDI214	577059	205 – 214 mm			M12, M16	40 mm	4.0 mm	M10	40 mm	5,000 N
HDI225	577061	219 – 225 mm	8"	200	M16, M20	40 mm	4.0 mm	M12	40 mm	10,000 N
HDI250	577064	244 – 250 mm			M16, M20	40 mm	4.0 mm	M12	40 mm	10,000 N
HDI273	577066	265 – 273 mm	10"	250	M16, M20	40 mm	4.0 mm	M12	40 mm	10,000 N
HDI316	577067	305 – 316 mm			M16, M20	40 mm	4.0 mm	M12	40 mm	10,000 N

Lining is EPDM rubber.

Mechanical

RUBBER LINED PIPE CLAMPS

PX HEAVY DUTY PIPE CLAMP WITH EXTERNAL THREAD

- Includes male/female combination nut
- Category II noise reduction according to DIN EN ISO 3822-1
- Compliant for sound insulation design according to DIN 4109
- Reaction-to-fire classification is "E" in compliance with DIN EN 13501-1:2010-01

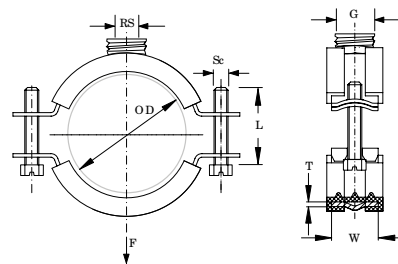

Temperature: -50 to 120 °C

Part Number	Article Number	Outer Diameter	Pipe Size	NB/DN	Gewinde	Rod Size	Width	Thickness	Screw Diameter	Screw Length
Material: Stainless Steel 316 (EN 1.4401), EPDM-SBR Rubber										
PXI013S6	578250	10 – 13 mm			1/2"	M10	27 mm	2.0 mm	M6	20 mm
PXI018S6	578260	14 – 18 mm	3/8"	10	1/2"	M10	27 mm	2.0 mm	M6	20 mm
PXI022S6	578270	19 – 22 mm	1/2"	15	1/2"	M10	27 mm	2.0 mm	M6	20 mm
PXI028S6	578280	23 – 28 mm	3/4"	20	1/2"	M10	27 mm	2.0 mm	M6	20 mm
PXI034S6	578290	29 – 34 mm	1"	25	1/2"	M10	27 mm	2.0 mm	M6	20 mm
PXI045S6	578310	41 – 45 mm	1 1/4"	32	1/2"	M10	27 mm	2.0 mm	M6	20 mm
PXI050S6	578320	46 – 50 mm	1 1/2"	40	1/2"	M10	27 mm	2.0 mm	M6	20 mm
PXI061S6	578340	56 – 61 mm	2"	50	1/2"	M10	31 mm	2.0 mm	M8	25 mm
PXI081S6	578370	75 – 81 mm	2 1/2"	65	1/2"	M10	31 mm	2.0 mm	M8	25 mm
PXI093S6	578390	88 – 93 mm	3"	80	1/2"	M10	31 mm	2.0 mm	M8	25 mm
PXI099S6	578400	94 – 99 mm			1/2"	M10	31 mm	2.0 mm	M8	25 mm
PXI105S6	578410	100 – 105 mm	3 1/2"		1/2"	M10	31 mm	2.0 mm	M8	25 mm
PXI111S6	578420	106 – 111 mm			1/2"	M10	31 mm	2.0 mm	M8	25 mm
PXI118S6	578430	112 – 118 mm	4"	100	1/2"	M10	31 mm	2.0 mm	M8	25 mm
PXI125S6	578440	119 – 125 mm			3/4"	M12	38 mm	2.5 mm	M8	30 mm
PXI145S6	578470	139 – 145 mm	5"	125	3/4"	M12	38 mm	2.5 mm	M8	30 mm
PXI151S6	578480	146 – 151 mm			3/4"	M12	38 mm	2.5 mm	M8	30 mm
PXI164S6	578500	158 – 164 mm			3/4"	M12	38 mm	2.5 mm	M8	30 mm
PXI170S6	578510	165 – 170 mm	6"	150	3/4"	M12	38 mm	2.5 mm	M8	30 mm
PXI180S6	578520	174 – 180 mm			3/4"	M12	38 mm	2.5 mm	M8	30 mm
PXI194S6	578540	188 – 194 mm			3/4"	M12	38 mm	2.5 mm	M8	30 mm
PXI201S6	578550	195 – 201 mm			3/4"	M12	38 mm	2.5 mm	M8	30 mm
PXI220S6	578570	215 – 220 mm	8"	200	3/4"	M12	38 mm	2.5 mm	M8	30 mm
Material: Steel, EPDM-SBR Rubber – Finish: Electrogalvanized										
PXI018EG	577870	14 – 18 mm	3/8"	10	1/2"	M10	27 mm	2.3 mm	M6	20 mm
PXI022EG	577880	19 – 22 mm	1/2"	15	1/2"	M10	27 mm	2.3 mm	M6	20 mm
PXI028EG	577890	23 – 28 mm	3/4"	20	1/2"	M10	27 mm	2.3 mm	M6	20 mm
PXI034EG	577900	29 – 34 mm	1"	25	1/2"	M10	27 mm	2.3 mm	M6	20 mm
PXI045EG	577920	41 – 45 mm	1 1/4"	32	1/2"	M10	27 mm	2.3 mm	M6	20 mm
PXI050EG	577930	46 – 50 mm	1 1/2"	40	1/2"	M10	27 mm	2.3 mm	M6	20 mm
PXI061EG	577950	56 – 61 mm	2"	50	1/2"	M10	31 mm	2.5 mm	M8	25 mm
PXI081EG	577980	75 – 81 mm	2 1/2"	65	1/2"	M10	31 mm	2.5 mm	M8	25 mm
PXI093EG	578000	88 – 93 mm	3"	80	1/2"	M10	31 mm	2.5 mm	M8	25 mm
PXI118EG	578040	112 – 118 mm	4"	100	1/2"	M10	31 mm	2.5 mm	M8	25 mm
PXI145EG	578080	139 – 145 mm	5"	125	3/4"	M12	38 mm	2.9 mm	M8	30 mm
PXI170EG	578120	165 – 170 mm	6"	150	3/4"	M12	38 mm	2.9 mm	M8	30 mm
PXI220EG	578180	215 – 220 mm	8"	200	3/4"	M12	38 mm	2.9 mm	M8	30 mm

Mechanical

RUBBER LINED PIPE CLAMPS

NVENT CADDY MICROFIX DOUBLE PIPE CLAMP

- Fast installation of parallel pipes from a single anchor
- Category II noise reduction according to DIN EN ISO 3822-1
- Compliant for sound insulation design according to DIN 4109
- Reaction-to-fire classification is "E" in compliance with DIN EN 13501-1:2010-01

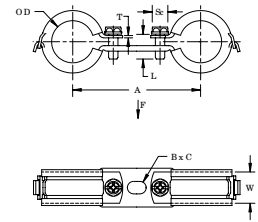

Material: Steel, EPDM-SBR Rubber
 Finish: Electrogalvanized
 Width: 20 mm
 Screw Diameter: M6
 Screw Length: 20 mm

Part Number	Article Number	Pipe Size	NB/DN	Outer Diameter	Thickness	A	B	C	Static Load
MDC019	596000	3/8"	10	15 – 19 mm	1.5 mm	72 mm	12 mm	8.5 mm	500 N
MDC023	596010	1/2"	15	21 – 23 mm	1.5 mm	76 mm	12 mm	8.5 mm	500 N
MDC028	596020	3/4"	20	26 – 28 mm	1.5 mm	82 mm	12 mm	8.5 mm	500 N
MDC035	596030	1"	25	32 – 35 mm	1.5 mm	89 mm	12 mm	8.5 mm	500 N

NVENT CADDY MICROFIX DOUBLE PIPE STRAP, ADJUSTABLE

- Fast installation of parallel pipes from a single anchor
- Height adjustable
- Category II noise reduction according to DIN EN ISO 3822-1
- Compliant for sound insulation design according to DIN 4109
- Reaction-to-fire classification is "E" in compliance with DIN EN 13501-1:2010-01

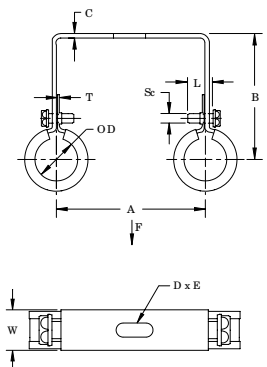
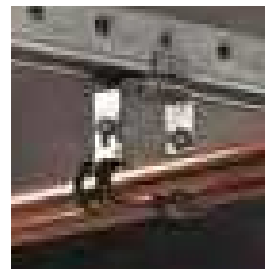

Material: Steel, EPDM-SBR Rubber
 Finish: Electrogalvanized
 Color: Black
 Temperature: -50 to 110 °C

Part Number	Article Number	Pipe Size	NB/DN	Outer Diameter	Width	Thickness	A	B	Static Load
MDS015	400659	1/4"	8	12 – 14 mm	20 mm	0.8 mm	60 mm	51 mm	450 N
MDS019	400660	3/8"	10	15 – 19 mm	20 mm	0.8 mm	60 mm	54 mm	450 N
MDS023	400661	1/2"	15	21 – 23 mm	20 mm	0.8 mm	60 mm	60 mm	450 N
MDS028	400662	3/4"	20	26 – 28 mm	20 mm	0.8 mm	90 mm	62 mm	450 N
MDS035	400663	1"	25	32 – 35 mm	20 mm	0.8 mm	90 mm	65 mm	450 N
MDS043	400664	1 1/4"	32	40 – 43 mm	20 mm	1.0 mm	90 mm	68 mm	450 N

C	D	E	Screw Diameter	Screw Length
2 mm	20 mm	8.5 mm	M6	20 mm

Mechanical

PIPE CLAMPS

HEAVY DUTY PIPE CLAMP PER DIN 3567

- For high static requirements in industrial construction
- Suitable for fix point applications
- Can be welded onto T-beam to form a sliding element

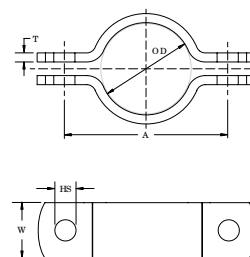

Material: Steel

Part Number	Article Number	Outer Diameter	Pipe Size	NB/DN	Hole Size	Width	Thickness	A
Finish: Hot-Dip Galvanized								
DIN021HD	400197	21.3 mm	1/2"	15	11.5 mm	30 mm	5 mm	58 mm
DIN027HD	400199	26.9 mm	3/4"	20	11.5 mm	30 mm	5 mm	64 mm
DIN034HD	400201	33.7 mm	1"	25	11.5 mm	30 mm	5 mm	72 mm
DIN042HD	400203	42.4 mm	1 1/4"	32	11.5 mm	30 mm	5 mm	82 mm
DIN048HD	400205	48.3 mm	1 1/2"	40	11.5 mm	30 mm	5 mm	88 mm
DIN060HD	400208	60.3 mm	2"	50	14.0 mm	40 mm	6 mm	108 mm
DIN076HD	400210	76.1 mm	2 1/2"	65	14.0 mm	40 mm	6 mm	122 mm
DIN089HD	400212	88.9 mm	3"	80	14.0 mm	40 mm	6 mm	136 mm
DIN102HD	400214	102.0 mm	3 1/2"	90	18.0 mm	50 mm	8 mm	166 mm
DIN114HD	400216	114.3 mm	4"	100	18.0 mm	50 mm	8 mm	178 mm
DIN140HD	400219	139.7 mm	5"	125	18.0 mm	50 mm	8 mm	204 mm
DIN168HD	400222	168.3 mm	6"	150	18.0 mm	50 mm	8 mm	232 mm
DIN219HD	400225	219.1 mm	8"	200	18.0 mm	50 mm	8 mm	284 mm
DIN273HD	400229	273.0 mm	10"	250	23.0 mm	60 mm	8 mm	348 mm
DIN323HD	400233	323.9 mm	12"	300	23.0 mm	60 mm	8 mm	398 mm
DIN355HD	400234	355.6 mm	14"	350	23.0 mm	60 mm	8 mm	432 mm
DIN406HD	400236	406.4 mm	16"	400	27.0 mm	70 mm	10 mm	498 mm
DIN457HD	400238	457.0 mm	18"	450	27.0 mm	70 mm	10 mm	548 mm
DIN508HD	400239	508.0 mm	20"	500	27.0 mm	70 mm	10 mm	600 mm
DIN610HD	400241	610.0 mm	24"	600	27.0 mm	70 mm	10 mm	710 mm
Finish: Plain								
DIN021PL	400149	21.3 mm	1/2"	15	11.5 mm	30 mm	5 mm	58 mm
DIN027PL	400151	26.9 mm	3/4"	20	11.5 mm	30 mm	5 mm	64 mm
DIN034PL	400153	33.7 mm	1"	25	11.5 mm	30 mm	5 mm	72 mm
DIN042PL	400155	42.4 mm	1 1/4"	32	11.5 mm	30 mm	5 mm	82 mm
DIN048PL	400157	48.3 mm	1 1/2"	40	11.5 mm	30 mm	5 mm	88 mm
DIN060PL	400160	60.3 mm	2"	50	14.0 mm	40 mm	6 mm	108 mm
DIN076PL	400162	76.1 mm	2 1/2"	65	14.0 mm	40 mm	6 mm	122 mm
DIN089PL	400164	88.9 mm	3"	80	14.0 mm	40 mm	6 mm	136 mm
DIN102PL	400166	102.0 mm	3 1/2"	90	18.0 mm	50 mm	8 mm	166 mm
DIN114PL	400168	114.3 mm	4"	100	18.0 mm	50 mm	8 mm	178 mm
DIN140PL	400171	139.7 mm	5"	125	18.0 mm	50 mm	8 mm	204 mm
DIN168PL	400174	168.3 mm	6"	150	18.0 mm	50 mm	8 mm	232 mm
DIN219PL	400177	219.1 mm	8"	200	18.0 mm	50 mm	8 mm	284 mm
DIN273PL	400181	273.0 mm	10"	250	23.0 mm	60 mm	8 mm	348 mm
DIN323PL	400185	323.9 mm	12"	300	23.0 mm	60 mm	8 mm	398 mm
DIN355PL	400186	355.6 mm	14"	350	23.0 mm	60 mm	8 mm	432 mm
DIN406PL	400188	406.4 mm	16"	400	27.0 mm	70 mm	10 mm	498 mm
DIN457PL	400190	457.0 mm	18"	450	27.0 mm	70 mm	10 mm	548 mm
DIN508PL	400191	508.0 mm	20"	500	27.0 mm	70 mm	10 mm	600 mm
DIN610PL	400193	610.0 mm	24"	600	27.0 mm	70 mm	10 mm	710 mm

Mechanical

PIPE CLAMPS

HEAVY DUTY PIPE CLAMP

- For high static requirements in industrial construction
- Suitable for fix point applications

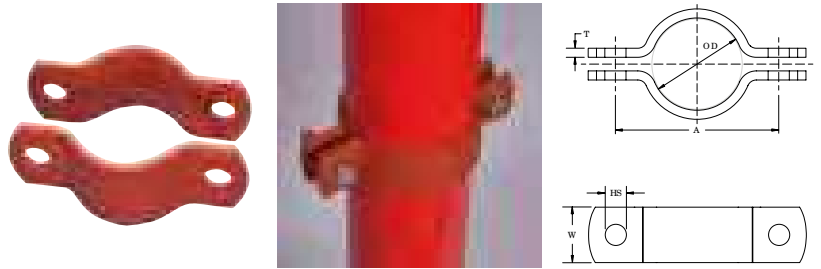

Material: Steel
Finish: Painted, Red Oxide

Part Number	Article Number	Outer Diameter	Pipe Size	NB/DN	Hole Size	Width	Thickness	A
SSG022RO	574600	20.5 – 22.0 mm	1/2"	15	6.6 mm	23 mm	3 mm	46 mm
SSG028RO	574610	26.5 – 28.0 mm	3/4"	20	6.6 mm	23 mm	3 mm	52 mm
SSG035RO	574620	33.0 – 35.0 mm	1"	25	11.0 mm	40 mm	4 mm	71 mm
SSG043RO	574630	40.0 – 43.0 mm	1 1/4"	32	11.0 mm	40 mm	4 mm	79 mm
SSG049RO	574640	48.0 – 49.0 mm	1 1/2"	40	11.0 mm	40 mm	4 mm	85 mm
SSG061RO	574650	57.0 – 60.3 mm	2"	50	11.0 mm	40 mm	4 mm	97 mm
SSG077RO	574660	75.0 – 77.0 mm	2 1/2"	65	11.0 mm	40 mm	4 mm	113 mm
SSG090RO	574670	88.0 – 90.0 mm	3"	80	11.0 mm	40 mm	4 mm	126 mm
SSG115RO	574680	110.0 – 115.0 mm	4"	100	18.0 mm	50 mm	6 mm	167 mm
SSG141RO	574685	139.0 – 141.0 mm	5"	125	18.0 mm	50 mm	6 mm	193 mm
SSG170RO	574690	165.0 – 170.0 mm	6"	150	18.0 mm	50 mm	6 mm	222 mm
SSG222RO	574700	216.0 – 222.0 mm	8"	200	22.0 mm	60 mm	8 mm	290 mm
SSG276RO	574710	267.0 – 276.0 mm	10"	250	22.0 mm	60 mm	8 mm	344 mm
SSG327RO	574720	321.0 – 327.0 mm	12"	300	22.0 mm	60 mm	8 mm	395 mm
SSG0359RO	574725	355.0 – 363.0 mm	14"		22.0 mm	60 mm	8 mm	427 mm
SSG410RO	574730	403.0 – 410.0 mm	16"	400	26.0 mm	70 mm	10 mm	492 mm

Mechanical

PIPE CLAMPS

HD NI HEAVY DUTY PIPE CLAMP, FIRE/SPRINKLER

- Fillet welded connector nut has flats to accommodate spanners
- Flared steel band also suitable for plastic pipe
- Easy open flange for pipe sizes up to and including 4"
- Adaptor bushings to female 1/2", 3/4", 1" available

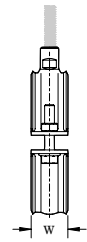
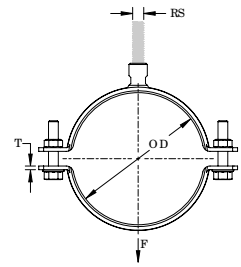
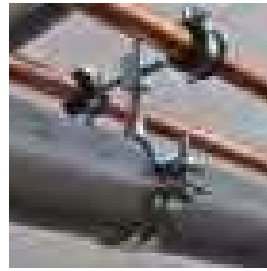
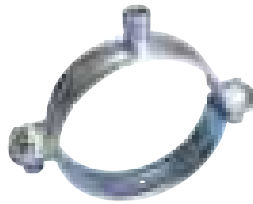

Nut Included: Yes
Material: Steel

Part Number	Article Number	Outer Diameter	Pipe Size	NB/DN	Rod Size	Width	Thickness	Static Load	Certifications
Finish: Electrogalvanized									
HDN019	577001	15 – 19 mm	3/8"	10	M8, M10	30 mm	2.5 mm	2,000 N	ITB
HDN024	577002	20 – 24 mm	1/2"	15	M8, M10	30 mm	2.5 mm	2,000 N	ITB
HDN030	577003	25 – 30 mm	3/4"	20	M8, M10	30 mm	2.5 mm	2,000 N	FM, ITB, VdS
HDN035	577004	31 – 35 mm	1"	25	M8, M10	30 mm	2.5 mm	2,000 N	FM, ITB, VdS
HDN041	577005	36 – 41 mm			M8, M10	30 mm	2.5 mm	2,000 N	ITB, VdS
HDN045	577006	40 – 45 mm	1 1/4"	32	M8, M10	30 mm	2.5 mm	2,000 N	FM, ITB, VdS
HDN053	577007	48 – 53 mm	1 1/2"	40	M8, M10	30 mm	2.5 mm	2,000 N	FM, ITB, VdS
HDN059	577008	54 – 59 mm			M8, M10	30 mm	2.5 mm	2,000 N	ITB, VdS
HDN065	577009	60 – 65 mm	2"	50	M8, M10	30 mm	2.5 mm	2,000 N	FM, ITB, VdS
HDN072	577010	61 – 72 mm			M8, M10	30 mm	2.5 mm	3,500 N	ITB, VdS
HDN081	577011	76 – 81 mm	2 1/2"	65	M10, M12	30 mm	3.0 mm	3,500 N	FM, ITB, VdS
HDN094	577013	88 – 94 mm	3"	80	M10, M12	30 mm	3.0 mm	3,500 N	FM, ITB, VdS
HDN102	577014	95 – 102 mm			M10, M12	30 mm	3.0 mm	3,500 N	ITB, VdS
HDN108	577015	102 – 108 mm			M10, M12	30 mm	3.0 mm	3,500 N	ITB, VdS
HDN116	577016	110 – 116 mm	4"	100	M10, M12	30 mm	3.0 mm	3,500 N	FM, ITB, VdS
HDN129	577018	124 – 129 mm			M10, M12	30 mm	3.0 mm	5,000 N	ITB, VdS
HDN140	577019	133 – 140 mm			M10, M12	40 mm	4.0 mm	5,000 N	ITB, VdS
HDN146	577020	140 – 146 mm	5"	125	M12, M16	40 mm	4.0 mm	5,000 N	FM, ITB, VdS
HDN155	577021	149 – 155 mm			M12, M16	40 mm	4.0 mm	5,000 N	ITB, VdS
HDN165	577022	159 – 165 mm			M12, M16	40 mm	4.0 mm	5,000 N	ITB, VdS
HDN173	577023	167 – 173 mm	6"	150	M12, M16	40 mm	4.0 mm	5,000 N	FM, ITB, VdS
HDN182	577024	176 – 182 mm			M12, M16	40 mm	4.0 mm	8,500 N	ITB
HDN194	577025	188 – 194 mm			M12, M16	40 mm	4.0 mm	8,500 N	ITB
HDN205	577026	199 – 205 mm			M12, M16	40 mm	4.0 mm	8,500 N	ITB
HDN216	577027	207 – 216 mm			M12, M16	40 mm	4.0 mm	8,500 N	ITB
HDN226	577028	219 – 226 mm	8"	200	M12, M16	40 mm	4.0 mm	8,500 N	ITB, VdS
HDN236	577029	227 – 236 mm			M16, M20	40 mm	4.0 mm	10,000 N	ITB
HDN250	577030	244 – 250 mm			M16, M20	40 mm	4.0 mm	10,000 N	ITB
HDN261	577031	251 – 261 mm			M16, M20	40 mm	4.0 mm	10,000 N	ITB
HDN273	577032	267 – 273 mm	10"	250	M16, M20	40 mm	4.0 mm	10,000 N	ITB, VdS
HDN316	577068	305 – 316 mm			M16, M20	40 mm	4.0 mm	10,000 N	ITB

Mechanical

PIPE CLAMPS

Part Number	Article Number	Outer Diameter	Pipe Size	NB/DN	Rod Size	Width	Thickness	Static Load	Certifications
Finish: Hot-Dip Galvanized									
HDN019HD	575001	15 – 19 mm	3/8"	10	M8, M10	30 mm	2.5 mm	2,000 N	
HDN024HD	575002	20 – 24 mm	1/2"	15	M8, M10	30 mm	2.5 mm	2,000 N	
HDN030HD	575003	25 – 30 mm	3/4"	20	M8, M10	30 mm	2.5 mm	2,000 N	FM, VdS
HDN035HD	575004	31 – 35 mm	1"	25	M8, M10	30 mm	2.5 mm	2,000 N	FM, VdS
HDN045HD	575006	40 – 45 mm	1 1/4"	32	M8, M10	30 mm	2.5 mm	2,000 N	FM, VdS
HDN053HD	575007	48 – 53 mm	1 1/2"	40	M8, M10	30 mm	2.5 mm	2,000 N	FM, VdS
HDN059HD	575008	54 – 59 mm			M8, M10	30 mm	2.5 mm	2,000 N	VdS
HDN065HD	575009	60 – 65 mm	2"	50	M8, M10	30 mm	2.5 mm	2,000 N	FM, VdS
HDN081HD	575011	76 – 81 mm	2 1/2"	65	M10, M12	30 mm	3.0 mm	3,500 N	FM, VdS
HDN094HD	575013	88 – 94 mm	3"	80	M10, M12	30 mm	3.0 mm	3,500 N	FM, VdS
HDN116HD	575016	110 – 116 mm	4"	100	M10, M12	30 mm	3.0 mm	3,500 N	FM, VdS
HDN129HD	575018	124 – 129 mm			M10, M12	30 mm	3.0 mm	5,000 N	VdS
HDN146HD	575020	140 – 146 mm	5"	125	M12, M16	40 mm	4.0 mm	5,000 N	FM, VdS
HDN165HD	575022	159 – 165 mm			M12, M16	40 mm	4.0 mm	5,000 N	VdS
HDN173HD	575023	167 – 173 mm	6"	150	M12, M16	40 mm	4.0 mm	5,000 N	FM, VdS
HDN226HD	575028	219 – 226 mm	8"	200	M12, M16	40 mm	4.0 mm	8,500 N	VdS
HDN273HD	575032	267 – 273 mm	10"	250	M16, M20	40 mm	4.0 mm	10,000 N	VdS

Mechanical

PIPE CLAMPS

PX NI HEAVY DUTY PIPE CLAMP WITH EXTERNAL THREAD

- Includes male/female combination nut
- Heavy duty

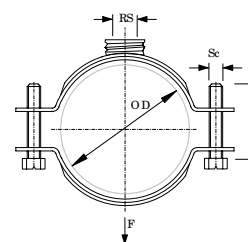
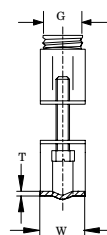

Nut Included: Yes

Part Number	Article Number	OD	Pipe Size	NB/DN	G	RS	W	T	Sc	L
Material: Stainless Steel 316 (EN 1.4401)										
PXN025S6	577460	21 – 25	1/2	15	1/2	M10	27	2.0	M6	20
PXN031S6	577470	26 – 31	3/4	20	1/2	M10	27	2.0	M6	20
PXN036S6	577480	32 – 36	1	25	1/2	M10	27	2.0	M6	20
PXN046S6	577500	41 – 46	1 1/4	32	1/2	M10	27	2.0	M6	20
PXN052S6	577510	47 – 52	1 1/2	40	1/2	M10	27	2.0	M6	20
PXN063S6	577530	59 – 63	2	50	1/2	M10	27	2.0	M6	20
PXN079S6	577560	74 – 79	2 1/2	65	1/2	M10	31	2.0	M8	25
PXN086S6	577570	80 – 86			1/2	M10	31	2.0	M8	25
PXN092S6	577580	87 – 92	3	80	1/2	M10	31	2.0	M8	25
PXN105S6	577600	100 – 105	3 1/2		1/2	M10	31	2.0	M8	25
PXN117S6	577620	112 – 117	4	100	1/2	M10	31	2.0	M8	25
PXN129S6	577640	124 – 129			1/2	M10	31	2.0	M8	25
PXN143S6	577660	137 – 143	5	125	3/4	M12	38	2.5	M8	30
PXN163S6	577690	157 – 163			3/4	M12	38	2.5	M8	30
PXN169S6	577700	164 – 169	6	150	3/4	M12	38	2.5	M8	30
PXN175S6	577710	170 – 175			3/4	M12	38	2.5	M8	30
PXN182S6	577720	176 – 182			3/4	M12	38	2.5	M8	30
PXN205S6	577750	199 – 205			3/4	M12	38	2.5	M8	30
PXN219S6	577770	213 – 219	8	200	3/4	M12	38	2.5	M8	30
PXN252S6	577800	246 – 252			3/4	M12	38	2.5	M8	30
Material: Steel – Finish: Electrogalvanized										
PXN025EG	577060	21 – 25	1/2	15	1/2	M10	27	2.2	M6	20
PXN031EG	577070	26 – 31	3/4	20	1/2	M10	27	2.2	M6	20
PXN036EG	577080	32 – 36	1	25	1/2	M10	27	2.2	M6	20
PXN046EG	577100	41 – 46	1 1/4	32	1/2	M10	27	2.2	M6	20
PXN052EG	577110	47 – 52	1 1/2	40	1/2	M10	27	2.2	M6	25
PXN063EG	577130	59 – 63	2	50	1/2	M10	27	2.2	M6	25
PXN073EG	577150	70 – 73			1/2	M10	27	2.2	M6	25
PXN079EG	577160	74 – 79	2 1/2	65	1/2	M10	31	2.5	M6	25
PXN092EG	577180	87 – 92	3	80	1/2	M10	31	2.5	M6	25
PXN117EG	577220	112 – 117	4	100	1/2	M10	31	2.5	M6	25
PXN143EG	577260	137 – 143	5	125	3/4	M12	38	2.9	M8	30
PXN169EG	577300	164 – 169	6	150	3/4	M12	38	2.9	M8	30
PXN219EG	577370	213 – 219	8	200	3/4	M12	38	2.9	M8	30
PXN252EG	577400	246 – 252			3/4	M12	38	2.9	M8	30

Mechanical

PIPE CLAMPS

NVENT CADDY MACROFIX NON-INSULATED M8/M10

- Plastic washer prevents screws from falling out during installation
- Combo head bolt works with slotted, hex, or Phillips drivers
- Longer ears position the screw farther from the hanger, improving tool clearance when the screw is tightened
- Combination nut can be attached to M8 or M10 threaded rod, simplifying material handling
- Screw length has been optimized to accommodate an increased pipe range, reducing inventory

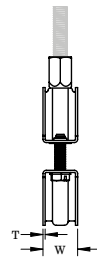
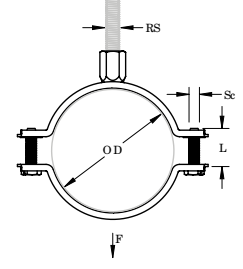

Material: Steel
Finish: Electrogalvanized

Part Number	Article Number	Outer Diameter	Pipe Size	NB/DN	Rod Size	Width	Thickness	Screw Diameter	Screw Length	Static Load
MFN019EG	586101	15 – 19 mm	3/8"	10	M8, M10	20 mm	1.00 mm	M6	17 mm	1,000 N
MFN023EG	586102	19 – 23 mm	1/2"	15	M8, M10	20 mm	1.00 mm	M6	17 mm	1,000 N
MFN029EG	586103	23 – 29 mm	3/4"	20	M8, M10	20 mm	1.00 mm	M6	17 mm	1,000 N
MFN035EG	586104	29 – 35 mm	1"	25	M8, M10	20 mm	1.00 mm	M6	17 mm	1,000 N
MFN041EG	586105	35 – 41 mm			M8, M10	20 mm	1.00 mm	M6	22 mm	1,000 N
MFN048EG	586106	41 – 48 mm	1 1/4"	32	M8, M10	20 mm	1.00 mm	M6	22 mm	1,000 N
MFN054EG	586107	48 – 54 mm	1 1/2"	40	M8, M10	20 mm	1.25 mm	M6	22 mm	1,500 N
MFN062EG	586108	54 – 62 mm	2"	50	M8, M10	20 mm	1.25 mm	M6	22 mm	1,500 N
MFN072EG	586109	62 – 72 mm			M8, M10	20 mm	1.25 mm	M6	22 mm	1,500 N
MFN083EG	586110	73 – 83 mm	2 1/2"	65	M8, M10	23 mm	1.50 mm	M6	27 mm	2,000 N
MFN093EG	586111	83 – 93 mm	3"	80	M8, M10	23 mm	1.50 mm	M6	27 mm	2,000 N
MFN103EG	586112	93 – 103 mm	3 1/2"	90	M8, M10	23 mm	1.75 mm	M6	27 mm	2,500 N
MFN113EG	586113	103 – 113 mm			M8, M10	23 mm	1.75 mm	M6	27 mm	2,500 N
MFN123EG	586114	113 – 123 mm	4"	100	M8, M10	23 mm	1.75 mm	M6	27 mm	2,500 N
MFN133EG	586115	123 – 133 mm			M8, M10	23 mm	2.00 mm	M6	27 mm	3,000 N
MFN143EG	586116	133 – 143 mm	5"	125	M8, M10	23 mm	2.00 mm	M6	27 mm	3,000 N
MFN153EG	586117	143 – 153 mm			M8, M10	25 mm	2.00 mm	M6	27 mm	3,200 N
MFN165EG	586118	155 – 165 mm			M8, M10	25 mm	2.00 mm	M6	27 mm	3,200 N
MFN175EG	586119	165 – 175 mm	6"	150	M8, M10	25 mm	2.00 mm	M6	27 mm	3,200 N
MFN205EG	586120	195 – 205 mm			M8, M10	27 mm	2.25 mm	M6	32 mm	3,600 N
MFN220EG	586121	210 – 220 mm	8"	200	M8, M10	27 mm	2.25 mm	M6	32 mm	3,600 N
MFN230EG	586122	220 – 230 mm			M8, M10	27 mm	2.25 mm	M6	32 mm	3,600 N
MFN255EG	586123	244 – 255 mm			M8, M10	30 mm	2.50 mm	M6	32 mm	4,000 N
MFN280EG	586124	270 – 280 mm	10"	250	M8, M10	30 mm	2.50 mm	M6	32 mm	4,000 N
MFN324EG	586125	314 – 324 mm	12"	300	M8, M10	30 mm	2.50 mm	M6	32 mm	4,000 N

Mechanical

PIPE CLAMPS

NVENT CADDY MACROFIX NON-INSULATED M8/M10, STAINLESS STEEL

- Plastic washer prevents screws from falling out during installation
- Combo head bolt works with slotted, hex, or Phillips drivers
- Longer ears position the screw farther from the hanger, improving tool clearance when the screw is tightened
- Combination nut can be attached to M8 or M10 threaded rod, simplifying material handling
- Screw length has been optimized to accommodate an increased pipe range, reducing inventory

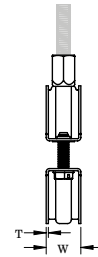
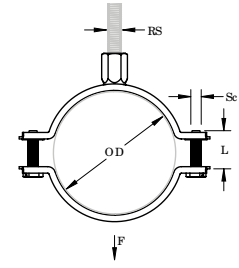

Material: Stainless Steel 316L (EN 1.4404)
Finish: Electropolished



Part Number	Article Number	Outer Diameter	Pipe Size	NB/DN	Rod Size	Width	Thickness	Screw Diameter	Screw Length	Static Load
MFN019S6	586401	15 – 19 mm	3/8"	10	M8, M10	20 mm	1.00 mm	M6	17 mm	1,000 N
MFN023S6	586402	19 – 23 mm	1/2"	15	M8, M10	20 mm	1.00 mm	M6	17 mm	1,000 N
MFN029S6	586403	23 – 29 mm	3/4"	20	M8, M10	20 mm	1.00 mm	M6	17 mm	1,000 N
MFN035S6	586404	29 – 35 mm	1"	25	M8, M10	20 mm	1.00 mm	M6	17 mm	1,000 N
MFN041S6	586405	35 – 41 mm			M8, M10	20 mm	1.00 mm	M6	22 mm	1,000 N
MFN048S6	586406	41 – 48 mm	1 1/4"	32	M8, M10	20 mm	1.00 mm	M6	22 mm	1,000 N
MFN054S6	586407	48 – 54 mm	1 1/2"	40	M8, M10	20 mm	1.25 mm	M6	22 mm	1,300 N
MFN062S6	586408	54 – 62 mm	2"	50	M8, M10	20 mm	1.25 mm	M6	22 mm	1,300 N
MFN072S6	586409	62 – 72 mm			M8, M10	20 mm	1.25 mm	M6	22 mm	1,300 N
MFN083S6	586410	73 – 83 mm	2 1/2"	65	M8, M10	23 mm	1.50 mm	M6	27 mm	1,500 N
MFN093S6	586411	83 – 93 mm	3"	80	M8, M10	23 mm	1.50 mm	M6	27 mm	1,500 N
MFN103S6	586412	93 – 103 mm	3 1/2"	90	M8, M10	23 mm	1.75 mm	M6	27 mm	1,800 N
MFN113S6	586413	103 – 113 mm			M8, M10	23 mm	1.75 mm	M6	27 mm	1,800 N
MFN123S6	586414	113 – 123 mm	4"	100	M8, M10	23 mm	1.75 mm	M6	27 mm	2,200 N
MFN133S6	586415	123 – 133 mm			M8, M10	23 mm	2.00 mm	M6	27 mm	2,200 N
MFN143S6	586416	133 – 143 mm	5"	125	M8, M10	23 mm	2.00 mm	M6	27 mm	2,200 N
MFN153S6	586417	143 – 153 mm			M8, M10	25 mm	2.00 mm	M6	27 mm	3,200 N
MFN165S6	586418	155 – 165 mm			M8, M10	25 mm	2.00 mm	M6	27 mm	3,200 N
MFN175S6	586419	165 – 175 mm	6"	150	M8, M10	25 mm	2.00 mm	M6	27 mm	3,200 N
MFN205S6	586420	195 – 205 mm			M8, M10	27 mm	2.25 mm	M6	32 mm	3,600 N
MFN220S6	586421	210 – 220 mm	8"	200	M8, M10	27 mm	2.25 mm	M6	32 mm	3,600 N
MFN230S6	586422	220 – 230 mm			M8, M10	27 mm	2.25 mm	M6	32 mm	3,600 N

Mechanical

PIPE CLAMPS

NVENT CADDY MACROFIX NI EZ WITH EASY CLOSURE

- Combo head bolt works with slotted, hex, or Phillips drivers
- Contains easy closing mechanism

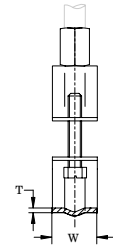
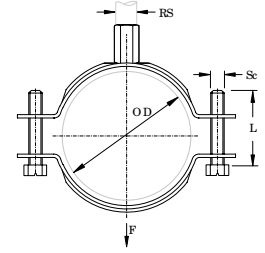
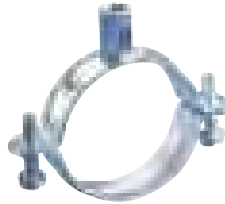

Material: Steel
Finish: Electrogalvanized

Part Number	Article Number	Outer Diameter	Pipe Size	NB/DN	Rod Size	Width	Thickness	Screw Diameter	Screw Length	Static Load
MXZ018	403600	14 – 18 mm	3/8"	10	M8, M10	20 mm	1.5 mm	M6	20 mm	800 N
MXZ026	403605	20 – 26 mm	1/2"	15	M8, M10	20 mm	1.5 mm	M6	20 mm	800 N
MXZ030	403610	23 – 30 mm	3/4"	20	M8, M10	20 mm	1.5 mm	M6	25 mm	800 N
MXZ040	403615	33 – 40 mm	1"	25	M8, M10	20 mm	1.5 mm	M6	20 mm	800 N
MXZ047	403620	41 – 47 mm	1 1/4"	32	M8, M10	20 mm	1.5 mm	M6	20 mm	800 N
MXZ054	403625	48 – 54 mm	1 1/2"	40	M8, M10	20 mm	2.0 mm	M6	25 mm	800 N
MXZ062	403630	56 – 62 mm	2"	50	M8, M10	20 mm	2.0 mm	M6	25 mm	1,050 N
MXZ069	403635	62 – 69 mm			M8, M10	20 mm	2.0 mm	M6	25 mm	1,050 N
MXZ078	403645	69 – 78 mm	2 1/2"	65	M8, M10	20 mm	2.0 mm	M6	40 mm	1,050 N
MXZ084	403650	76 – 84 mm			M8, M10	20 mm	2.0 mm	M6	25 mm	1,050 N
MXZ091	403655	85 – 91 mm	3"	80	M8, M10	20 mm	2.0 mm	M6	25 mm	1,050 N
MXZ098	403660	90 – 98 mm			M8, M10	23 mm	2.5 mm	M6	25 mm	1,050 N
MXZ107	403665	97 – 107 mm			M8, M10	23 mm	2.5 mm	M6	25 mm	1,050 N
MXZ110	403670	104 – 110 mm			M8, M10	23 mm	2.5 mm	M6	25 mm	1,050 N
MXZ116	403675	108 – 116 mm	4"	100	M8, M10	23 mm	2.5 mm	M8	40 mm	1,050 N
MXZ126	403680	116 – 126 mm			M8, M10	23 mm	2.5 mm	M8	30 mm	1,050 N
MXZ141	403690	133 – 141 mm			M8, M10	23 mm	2.5 mm	M8	25 mm	1,750 N
MXZ154	403695	144 – 154 mm			M8, M10	23 mm	2.5 mm	M8	40 mm	1,750 N
MXZ168	403705	159 – 168 mm	6"	150	M8, M10	23 mm	2.5 mm	M8	50 mm	1,750 N
MXZ184	403715	174 – 184 mm			M8, M10	30 mm	3.0 mm	M8	50 mm	1,750 N
MXZ195	403720	184 – 195 mm			M8, M10	30 mm	3.0 mm	M8	50 mm	1,750 N
MXZ218	403730	207 – 218 mm	8"	200	M8, M10	30 mm	3.0 mm	M8	50 mm	2,100 N

Mechanical

PIPE CLAMPS

NVENT CADDY MACROFIX PLUS NI EZ WITH EASY CLOSURE

- Contains easy closing mechanism
- Plastic washers help prevent crushing the CPVC or plastic pipe and assure a floating fit
- Flared edges and specially designed welding area help protect CPVC piping
- Suitable for 3/4" - 2" (20 - 50 DN) steel sprinkler pipe
- Combo head bolt works with slotted, hex, or Phillips drivers
- Conforms with Manufacturers Standardization Society (MSS) SP-58 (Type 12)

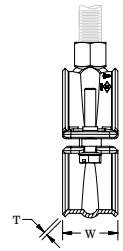

Material: Steel
Finish: Electrogalvanized

Part Number	Article Number	Pipe Size	NB/DN	Outer Diameter	Rod Size	Width	Thickness	Static Load	Certifications
MPZ020	595052	1/2"	15	20.0 – 21.3 mm	M10	30 mm	1.5 mm	1,125 N	
MPZ025	595053	3/4"	20	25.0 – 26.9 mm	M10	30 mm	1.5 mm	1,125 N	cULus, FM
MPZ032	595054	1"	25	32.0 – 33.7 mm	M10	30 mm	1.5 mm	1,125 N	cULus, FM
MPZ040	595056	1 1/4"	32	40.0 – 42.4 mm	M10	30 mm	1.5 mm	1,125 N	cULus, FM
MPZ050	595057	1 1/2"	40	48.3 – 50.0 mm	M10	30 mm	2.0 mm	1,725 N	cULus, FM
MPZ063	595059	2"	50	60.3 – 63.0 mm	M10	30 mm	2.0 mm	1,725 N	cULus, FM
MPZ075	595061	2 1/2"	65	75.0 – 76.1 mm	M10	30 mm	2.0 mm	1,725 N	cULus
MPZ090	595062	3"	80	88.9 – 90.0 mm	M10	30 mm	2.0 mm	1,725 N	cULus
MPZ110	595063	4"	100	110.0 – 114.3 mm	M10	30 mm	2.5 mm	2,000 N	cULus

DUPLO NI DOUBLE PIPE CLAMP

- Fast installation of parallel pipes from a single anchor
- Height adjustable

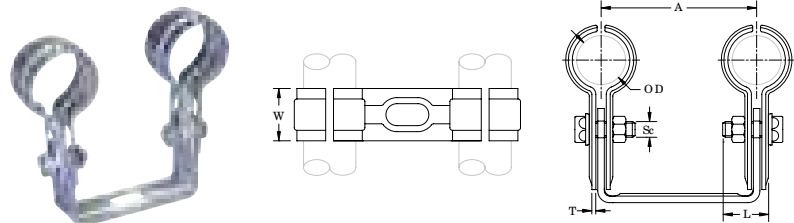

Material: Steel
Finish: Electrogalvanized

Part Number	Article Number	Outer Diameter	Pipe Size	NB/DN	Width	Thickness	A	Screw Diameter	Screw Length
DUPLON15EG	596040	15 mm			20 mm	1.5 mm	60 mm	M6	16 mm
DUPLON22EG	596041	22 mm	1/2"	15	20 mm	1.5 mm	60 mm	M6	16 mm
DUPLON28EG	596042	28 mm	3/4"	20	20 mm	1.5 mm	60 mm	M6	16 mm

Mechanical

PIPE CLAMPS

OVAL PIPE CLAMP WITH NUT

- Designed to support pre-insulated twin tubes and integrated power cable for solar heat collectors
- Shape of clamp provides a stable attachment to wall or ceiling

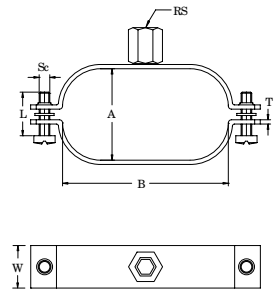
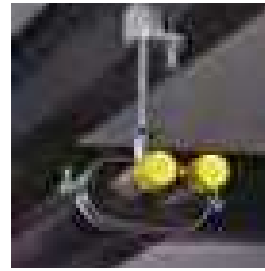

Material: Steel
Finish: Electrogalvanized

Part Number	Article Number	NB/DN	Rod Size	A	B	Width	Thickness	Screw Diameter	Screw Length
MXOVDN1012EG	401161	10, 12	M8, M10	30 mm	69 mm	20 mm	2 mm	M6	20 mm
MXOVDN1215EG	401244	12, 15	M8, M10	43 mm	78 mm	20 mm	2 mm	M6	20 mm
MXOVDN1618EG	401245	16, 18	M8, M10	51 mm	88 mm	20 mm	2 mm	M6	20 mm
MXOVDN20EG	401246	20	M8, M10	58 mm	108 mm	20 mm	2 mm	M6	20 mm
MXOVDN25EG	403800	25	M8, M10	71 mm	124 mm	20 mm	2 mm	M6	20 mm

NVENT CADDY EZ RISER

- One-piece hinge design comes out of the box ready to install
- Lack of loose hardware eliminates dropped or lost components, eliminating potential rework and speeding up installation
- Carriage bolts seat into clamp, eliminating the need for multiples tools when tightening
- Installs up to 60% faster than standard riser clamps and 45% faster than the industry-leading first generation EZ Riser
- Multi-functional clamp can be installed in several approved orientations, simplifying material handling
- Integrated second set of bolt holes allow the assembly to easily adapt from a riser clamp into a stand-off support
- In spaces where full-sized riser clamps do not fit, integrated score marks allow for easy removal of ears
- Retains listing when the ears are removed for close quarters, uniquely making the nVent CADDY EZ Riser capable of a listing in both installations
- Recommended for suspending vertical steel pipe risers
- No need to stock and use separate part families for standard and close quarter clamps to offer a full range of listed parts, reducing inventory by 38%
- Conforms with Federal Specification WW-H-171 (Type 8), Manufacturers Standardization Society (MSS) SP-58 (Type 8)

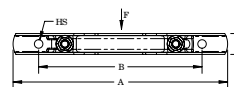
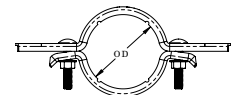

Material: Steel
Finish: Electrogalvanized



Part Number	Article Number	Pipe Size	Outer Diameter	Hole Size	A	B	C	Static Load
EZR0250	179231	2 1/2"	73.0 mm	9.9 mm	279.4 mm	190.5 mm	25.4 mm	1,735 N
EZR0300	179232	3"	88.9 mm	9.9 mm	298.5 mm	206.4 mm	25.4 mm	2,400 N
EZR0350	179233	3 1/2"	101.6 mm	13.2 mm	320.7 mm	238.1 mm	31.8 mm	2,980 N
EZR0400	179234	4"	114.3 mm	13.2 mm	330.2 mm	254.0 mm	31.8 mm	3,600 N
EZR0600	179236	6"	168.3 mm	13.2 mm	406.4 mm	323.9 mm	38.1 mm	6,900 N

Clamp is fitted for steel pipe and should be installed below a coupling or shear lug, with bolts torqued to recommended value. Use of a socket or driver is recommended for installation.

Mechanical

PIPE CLAMPS

700 OFFSET PIPE CLAMP

- Industrial pipe hanger to support piping away from wall or floor

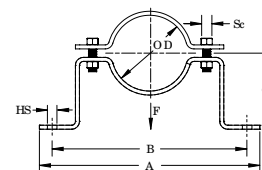

Material: Stainless Steel 304 (EN 1.4301)

Part Number	Article Number	Pipe Size	NB/DN	Outer Diameter	Hole Size	A	B	C	Screw Diameter	Static Load
7000250S4	702065	2 1/2"	65	76.1 mm	11.11 mm	304.8 mm	266.7 mm	81 mm	3/8"	1,820 N

STRC CU STRAP CLAMP FOR COPPER TUBE

- Includes fasteners, screw and nut

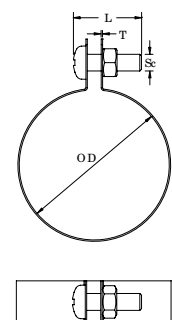

Material: Copper

Part Number	Article Number	Outer Diameter	Width	Thickness	Screw Diameter	Screw Length
STRC012CU	574170	12 mm	15 mm	0.6 mm	M6	16 mm
STRC015CU	574180	15 mm	15 mm	0.6 mm	M6	16 mm
STRC018CU	574190	18 mm	15 mm	0.6 mm	M6	16 mm
STRC022CU	574200	22 mm	15 mm	0.6 mm	M6	16 mm
STRC028CU	574210	28 mm	15 mm	0.6 mm	M6	16 mm

Mechanical

PIPE/TUBE TO STRUT

NVENT CADDY CUSHION CLAMP INSULATED STRUT CLAMP FOR PIPE/TUBE

- Fits into open side of strut channel
- Plastic cushion is hinged to spread apart for easy installation
- Reduces noise and absorbs shock by gripping the pipe/tube firmly
- Square neck of carriage bolt prevents over-tightening
- Nylon locknut prevents loosening under vibration
- FM® Specification Tested (from 3/8" to 4" of Copper Tube Size)

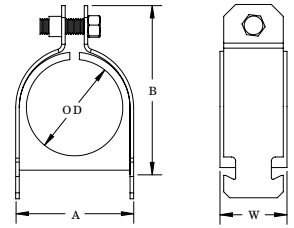

Material: Steel, Polypropylene
Finish: Electrogalvanized

Part Number	Article Number	Outer Diameter	Copper Tube Size	Pipe Size	NB/DN	Width	A	B
CCC0037	598883	9.5 mm	1/4"			39.7 mm	18.9 mm	35.4 mm
CCC0050	598884	12.7 mm	3/8"	1/4"	8	39.7 mm	22.1 mm	38.6 mm
CCC0062	598886	15.8 mm	1/2"	3/8"	10	39.7 mm	25.2 mm	41.7 mm
CCC0075	598888	19.1 mm	5/8"			39.7 mm	28.4 mm	44.9 mm
CCC0087	598891	22.2 mm	3/4"	1/2"	15	39.7 mm	31.6 mm	48.1 mm
CCC0100	598892	25.4 mm		3/4"	20	39.7 mm	34.8 mm	51.3 mm
CCC0112	598894	28.6 mm	1"			39.7 mm	39.0 mm	62.4 mm
CCC0125	598895	31.8 mm		1"	25	39.7 mm	42.1 mm	65.6 mm
CCC0162	598899	41.3 mm	1 1/2"	1 1/4"	32	39.7 mm	51.6 mm	75.1 mm
CCC0187	598903	47.6 mm		1 1/2"	40	39.7 mm	59.0 mm	81.5 mm
CCC0212	598906	53.9 mm	2"			39.7 mm	68.5 mm	91.0 mm
CCC0237	598908	60.3 mm		2"	50	39.7 mm	74.9 mm	97.4 mm
CCC0450	598957	114.3 mm		4"	100	39.7 mm	132.0 mm	160.5 mm

Mechanical

PIPE/TUBE TO STRUT

USC UNIVERSAL STRUT CLAMP FOR PIPE/CONDUIT

- Consists of two clamps, nut and bolt
- Fits into open side of strut channel
- Conforms with Manufacturers Standardization Society (MSS) SP-58 (Type 59)

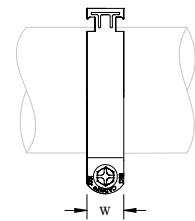
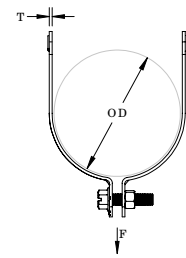

Material: Steel

Part Number	Article Number	Outer Diameter	Pipe Size	NB/DN	Width	Thickness	Static Load
Finish: Electrogalvanized							
USC016EG	712030	14.6 – 15.9 mm			32 mm	1.5 mm	2,000 N
USC020EG	712040	17.9 – 20.0 mm			32 mm	1.5 mm	2,000 N
USC021EG	712045	20.5 – 21.4 mm	1/2"	15	32 mm	1.5 mm	2,000 N
USC022EG	712050	21.5 – 22.2 mm			32 mm	1.5 mm	2,000 N
USC025EG	712060	23.4 – 25.4 mm			32 mm	1.5 mm	2,000 N
USC026EG	712065	25.4 – 26.9 mm	3/4"	20	32 mm	1.5 mm	2,000 N
USC028EG	712070	27.9 – 28.9 mm			32 mm	1.5 mm	2,000 N
USC031EG	712080	29.5 – 32.0 mm			32 mm	1.5 mm	2,000 N
USC033EG	712085	32.8 – 33.4 mm	1"		32 mm	1.5 mm	2,000 N
USC036EG	712090	33.7 – 38.1 mm		25	32 mm	2.0 mm	2,670 N
USC040EG	712100	38.4 – 40.6 mm			32 mm	2.0 mm	2,670 N
USC042EG	712105	41.3 – 42.4 mm	1 1/4"	32	32 mm	2.0 mm	2,670 N
USC046EG	712110	43.0 – 45.0 mm			32 mm	2.0 mm	2,670 N
USC048EG	712115	47.6 – 50.0 mm	1 1/2"	40	32 mm	2.0 mm	2,670 N
USC053EG	712120	50.3 – 53.7 mm			32 mm	2.5 mm	3,780 N
USC060EG	712035	59.5 – 62.2 mm	2"	50	32 mm	2.5 mm	3,780 N
USC063EG	712140	62.3 – 64.5 mm			32 mm	2.5 mm	3,780 N
USC073EG	712160	69.9 – 73.0 mm	2 1/2"		32 mm	2.5 mm	3,780 N
USC076EG	712165	75.3 – 76.2 mm		65	32 mm	2.5 mm	3,780 N
USC086EG	712180	84.0 – 88.9 mm	3"	80	32 mm	2.5 mm	3,780 N
USC101EG	712200	98.4 – 102.6 mm	3 1/2"	90	32 mm	2.5 mm	3,780 N
USC113EG	712220	111.1 – 115.3 mm	4"	100	32 mm	2.5 mm	3,780 N
USC143EG	712260	139.7 – 146.1 mm	5"	125	32 mm	3.0 mm	4,000 N
USC159EG	712280	155.6 – 162.0 mm			32 mm	3.0 mm	4,000 N
USC168EG	712290	165.1 – 171.5 mm	6"	150	32 mm	3.0 mm	4,000 N
USC178EG	712300	174.6 – 181.0 mm			32 mm	3.0 mm	4,000 N
USC218EG	712340	215.9 – 219.1 mm	8"	200	32 mm	3.0 mm	4,000 N

Mechanical

PIPE FIXINGS

Part Number	Article Number	Outer Diameter	Pipe Size	NB/DN	Width	Thickness	Static Load
Finish: Hot-Dip Galvanized							
USC021HD	712405	20.5 – 21.4 mm	1/2"	15	32 mm	1.5 mm	2,000 N
USC022HD	712410	21.5 – 22.2 mm			32 mm	1.5 mm	2,000 N
USC026HD	712422	25.4 – 26.9 mm	3/4"	20	32 mm	1.5 mm	2,000 N
USC033HD	712428	32.8 – 33.4 mm	1"		32 mm	1.5 mm	2,000 N
USC036HD	712430	33.7 – 38.1 mm		25	32 mm	2.0 mm	2,670 N
USC042HD	712445	41.3 – 42.4 mm	1 1/4"	32	32 mm	2.0 mm	2,670 N
USC048HD	712452	47.6 – 50.0 mm	1 1/2"	40	32 mm	2.0 mm	2,670 N
USC058HD	712460	55.8 – 57.2 mm			32 mm	2.5 mm	3,780 N
USC060HD	712465	59.5 – 62.2 mm	2"	50	32 mm	2.5 mm	3,780 N
USC076HD	712475	75.3 – 76.2 mm		65	32 mm	2.5 mm	3,780 N
USC086HD	712480	84.0 – 88.9 mm	3"	80	32 mm	2.5 mm	3,780 N
USC113HD	712490	111.1 – 115.3 mm	4"	100	32 mm	2.5 mm	3,780 N
USC218HD	712520	215.9 – 219.1 mm	8"	200	32 mm	3.0 mm	4,000 N
USC277HD	712530	273.0 – 280.0 mm	10"	250	32 mm	3.0 mm	4,000 N

NVENT CADDY SUPERKLIP

- Closes and locks automatically when the pipe, tube or cable is inserted
- One-piece clamp for fast and convenient installation
- Fasten with either wood screw, dual threaded screw with or without collar, nail with collar, threaded rod, mounting plate or shot-fire bracket
- M6 and M8 insert nuts available

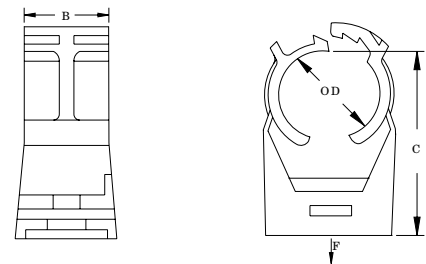
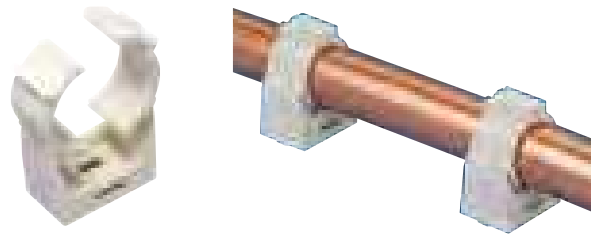

Material: Xenoy®
Temperature: -25 to 90 °C

Part Number	Outer Diameter	Pipe Size	Copper Tube Size	B	C	Static Load
389017	7.8 – 9.5 mm		1/4"	17.1 mm	26.4 mm	135 N
389018	9.5 – 11.8 mm		1/4"	17.1 mm	26.4 mm	150 N
389001	11.8 – 14.3 mm		3/8"	17.2 mm	29.9 mm	160 N
389002	14.3 – 16.8 mm		1/2"	19.5 mm	32.0 mm	175 N
389003	16.8 – 19.5 mm	3/8"	5/8"	20.0 mm	35.4 mm	190 N
389004	19.5 – 21.8 mm	1/2"		20.0 mm	39.4 mm	200 N
389005	21.8 – 24.8 mm		3/4"	20.0 mm	42.0 mm	215 N
389006	24.8 – 27.8 mm	3/4"		20.2 mm	45.1 mm	240 N
389007	27.8 – 31.2 mm		1"	20.2 mm	48.9 mm	260 N
389008	31.2 – 35.5 mm	1"	1 1/4"	21.0 mm	54.4 mm	300 N
389009	35.5 – 39.5 mm		1 1/4"	21.0 mm	59.4 mm	320 N
389011	39.5 – 43.5 mm	1 1/4"	1 1/2"	21.0 mm	64.2 mm	360 N
389013	50.5 – 55.5 mm		2"	23.0 mm	78.7 mm	400 N

Mechanical

PIPE FIXINGS

NVENT CADDY SUPERKLIP IN INSERT NUT

- Steel channel nut fits in the side of the nVent CADDY Superklip

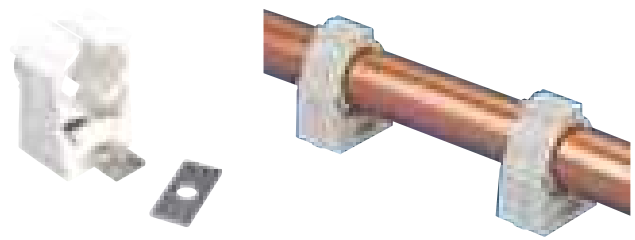

Material: Steel
Finish: Electrogalvanized

Part Number	Rod Size
389051	M6
389052	M8

RING FRF /1 SINGLE PIPE CLIP WITH PLUG

- Hammer in plastic clip to hold one pipe/ conduit
- Fix into drilled hole in brick or concrete

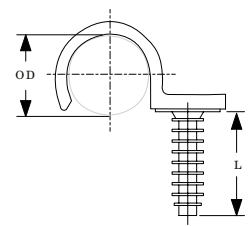
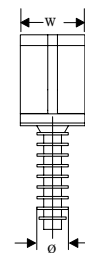

Material: Polyamide

Part Number	Article Number	Outer Diameter	Length	Width	Diameter	Drill Bit Diameter
FRF014	571130	14 mm	30 mm	20 mm	9.8 mm	8 mm
FRF016	571140	16 mm	30 mm	20 mm	9.8 mm	8 mm
FRF018	571150	18 mm	30 mm	20 mm	9.8 mm	8 mm
FRF020	571160	20 mm	30 mm	20 mm	9.8 mm	8 mm
FRF022	571170	22 mm	30 mm	20 mm	9.8 mm	8 mm
FRF025	571180	25 mm	30 mm	20 mm	9.8 mm	8 mm
FRF028	571190	28 mm	30 mm	20 mm	9.8 mm	8 mm

Mechanical

PIPE FIXINGS

RING FRF /2 DOUBLE PIPE CLIP WITH PLUG

- Hammer in plastic clip to hold 2 pipes/ conduit
- Fix into drilled hole in brick or concrete

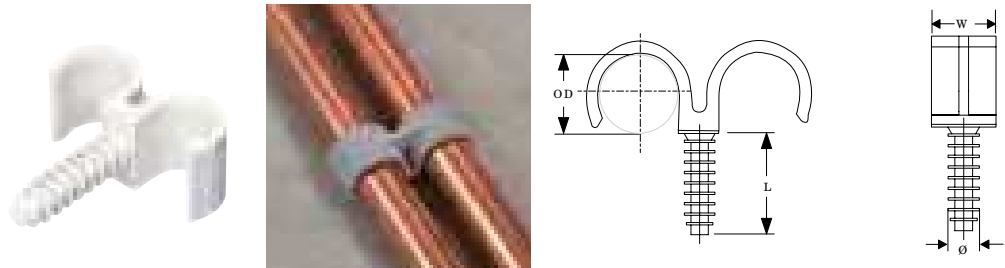

Material: Polyamide

Part Number	Article Number	Outer Diameter	Length	Width	Diameter	Drill Bit Diameter
FRF016X2	571200	16 mm	30 mm	20 mm	9.8 mm	8 mm
FRF018X2	571210	18 mm	30 mm	20 mm	9.8 mm	8 mm
FRF020X2	571220	20 mm	30 mm	20 mm	9.8 mm	8 mm
FRF022X2	571230	22 mm	30 mm	20 mm	9.8 mm	8 mm
FRF025X2	571240	25 mm	30 mm	20 mm	9.8 mm	8 mm
FRF028X2	571250	28 mm	30 mm	20 mm	9.8 mm	8 mm

2HPS TWO HOLE PIPE STRAP

- Light duty support of pipe
- Attaches directly to the face of a horizontal or vertical structural member

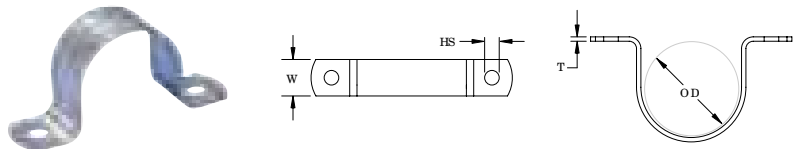

Material: Steel
Finish: Pregalvanized

Part Number	Article Number	Pipe Size	NB/DN	Outer Diameter	Hole Size	Width	Thickness
008017EG	400678	3/8"	10	17.2 mm	7 mm	20 mm	1 mm
008021EG	400679	1/2"	15	21.3 mm	7 mm	20 mm	1 mm
008027EG	400680	3/4"	20	26.9 mm	7 mm	20 mm	1 mm
008034EG	400681	1"	25	33.7 mm	7 mm	20 mm	1 mm
008042EG	400682	1 1/4"	32	42.4 mm	7 mm	20 mm	1 mm
008048EG	400683	1 1/2"	40	48.3 mm	7 mm	20 mm	1 mm
008060EG	400684	2"	50	60.3 mm	7 mm	20 mm	1 mm

Mechanical

PIPE FIXINGS

TWO HOLE DOUBLE PIPE SADDLE

- One hole strap for two pipes

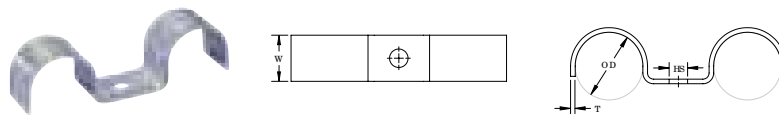

Material: Steel
Finish: Pregalvanized

Part Number	Article Number	Pipe Size	NB/DN	Outer Diameter	Hole Size	Width	Thickness
DPS025	400676	1/2"	15	25 mm	7 mm	20 mm	1.5 mm

PIPE HOOK

- Forged flat steel
- For steel, cast iron, and lead pipes



Material: Steel

Part Number	Article Number	Pipe Size	NB/DN	Outer Diameter
Finish: Electrogalvanized				
UPH0050EG	400320	1/2"	15	21.3 mm
UPH0075EG	400321	3/4"	20	26.9 mm
Finish: Plain				
UPH0050PL	400313	1/2"	15	21.3 mm
UPH0075PL	400314	3/4"	20	26.9 mm

Mechanical

PIPE FIXINGS

107 WRAPAROUND STRAP FOR CPVC PIPE

- Includes flared edges to protect piping
- Rated for use with CPVC fire sprinkler pipe
- Includes mounting screw

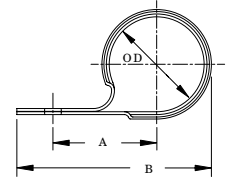
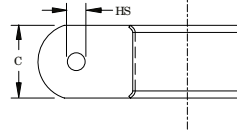

Material: Steel
Finish: Pregalvanized



Part Number	Article Number	Pipe Size	NB/DN	Outer Diameter	Hole Size	A	B	C	Hanger Spacing
1070075EG	597816	3/4"	20	26.9 mm	5.8 mm	31.8 mm	60.3 mm	30.2 mm	1.65 m Max
1070100EG	597817	1"	25	33.7 mm	5.8 mm	36.5 mm	68.3 mm	30.2 mm	1.80 m Max
1070125EG	597818	1 1/4"	32	42.2 mm	5.8 mm	41.3 mm	77.8 mm	30.2 mm	1.95 m Max
1070150EG	597819	1 1/2"	40	48.3 mm	5.8 mm	44.5 mm	84.1 mm	30.2 mm	2.10 m Max
1070200EG	597821	2"	50	60.3 mm	5.8 mm	47.6 mm	93.7 mm	30.2 mm	2.40 m Max

108 TWO HOLE STRAP FOR CPVC PIPE

- Includes flared edges to protect piping
- Rated for use with CPVC fire sprinkler pipe
- Includes mounting screws

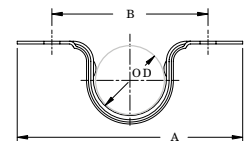
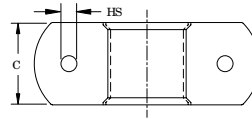

Material: Steel
Finish: Pregalvanized



Part Number	Article Number	Pipe Size	NB/DN	Outer Diameter	Hole Size	A	B	C	Hanger Spacing
1080075EG	597822	3/4"	20	26.9 mm	5.8 mm	82.6 mm	57.2 mm	30.2 mm	1.65 m Max
1080100EG	597823	1"	25	33.7 mm	5.8 mm	88.9 mm	63.5 mm	30.2 mm	1.80 m Max
1080125EG	597824	1 1/4"	32	42.2 mm	5.8 mm	108.0 mm	82.6 mm	30.2 mm	1.95 m Max
1080150EG	597825	1 1/2"	40	48.3 mm	5.8 mm	112.7 mm	87.3 mm	30.2 mm	2.10 m Max
1080200EG	597826	2"	50	60.3 mm	5.8 mm	125.4 mm	100.0 mm	30.2 mm	2.40 m Max

Mechanical

PIPE FIXINGS

109 SIDE MOUNT STRAP FOR CPVC PIPE

- Includes flared edges to protect piping
- Rated for use with CPVC fire sprinkler pipe
- Includes mounting screws

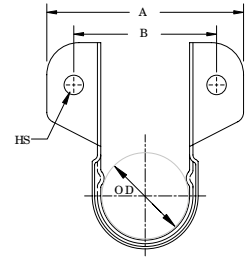
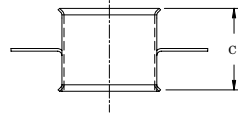

Material: Steel
Finish: Pregalvanized



Part Number	Article Number	Pipe Size	NB/DN	Outer Diameter	Hole Size	A	B	C	Hanger Spacing
1090075EG	597827	3/4"	20	26.9 mm	5.8 mm	58.7 mm	42.9 mm	30.2 mm	1.65 m Max
1090100EG	597828	1"	25	33.7 mm	5.8 mm	66.7 mm	49.2 mm	30.2 mm	1.80 m Max
1090125EG	597829	1 1/4"	32	42.2 mm	5.8 mm	74.6 mm	58.7 mm	30.2 mm	1.95 m Max
1090150EG	597831	1 1/2"	40	48.3 mm	5.8 mm	81.0 mm	63.5 mm	30.2 mm	2.10 m Max
1090200EG	597832	2"	50	60.3 mm	5.8 mm	92.1 mm	76.2 mm	30.2 mm	2.40 m Max

SOSR STAND OFF TWO HOLE STRAP FOR CPVC PIPE

- Includes flared edges to protect piping
- Rated for use with CPVC fire sprinkler pipe
- Positions pipe 1-1/2" (38 mm) off the mounting surface eliminating the need for wooden spacer blocks
- Can be mounted in both vertical and horizontal positions on concrete, steel and wood
- Meets the UL® 203 stringent upward thrust requirement
- UL® Listed as both a hanger and pipe restrainer
- Complies with static load requirements of NFPA® 13
- Includes mounting screws
- Can be used with 3TW backing nut on composite wood joist installations

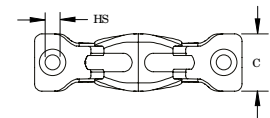
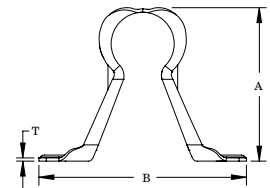
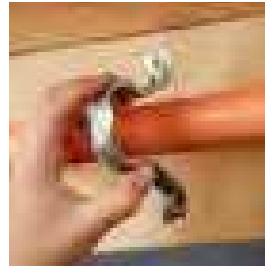

Material: Steel
Finish: Pregalvanized



Part Number	Article Number	Pipe Size	NB/DN	Hole Size	A	B	C	Thickness	Hanger Spacing	Standard Packaging Quantity
SOSR075	597805	3/4"	20	5.1 mm	68 mm	92 mm	25.4 mm	1.30 mm	1.65 m Max	100 pc
SOSR100	597806	1"	25	5.1 mm	75 mm	94 mm	25.4 mm	1.30 mm	1.80 m Max	100 pc
SOSR125	597807	1 1/4"	32	5.1 mm	84 mm	92 mm	25.4 mm	1.61 mm	1.95 m Max	100 pc
SOSR150	597808	1 1/2"	40	5.1 mm	98 mm	114 mm	25.4 mm	1.61 mm	2.10 m Max	100 pc
SOSR200	597809	2"	50	5.1 mm	102 mm	133 mm	25.4 mm	1.61 mm	2.40 m Max	100 pc

Mechanical

PIPE FIXINGS

U-BOLT

- Complete with 4 nuts

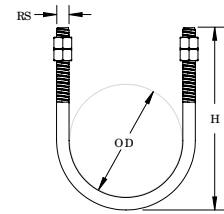
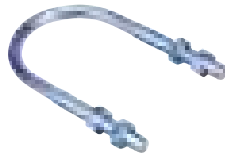

Part Number	Article Number	Outer Diameter	Pipe Size	NB/DN	Rod Size	Height
Material: Stainless Steel 316 (EN 1.4401)						
UB4N017M8S6	599345	17 mm	3/8"	10	M8	42 mm
UB4N021M8S6	599346	21 mm	1/2"	15	M8	46 mm
UB4N027M8S6	597615	27 mm	3/4"	20	M8	58 mm
UB4N034M8S6	597625	34 mm	1"	25	M8	63 mm
UB4N042M8S6	597635	42 mm	1 1/4"	32	M8	76 mm
UB4N049M8S6	597645	49 mm	1 1/2"	40	M8	78 mm
UB4N060M8S6	597655	60 mm	2"	50	M8	88 mm
UB4N076M8S6	597665	76 mm	2 1/2"	65	M8	118 mm
UB4N090M8S6	599357	90 mm	3"	80	M8	125 mm
UB4N114M8S6	599348	114 mm	4"	100	M8	166 mm
UB4N140M8S6	599350	140 mm	5"	125	M8	197 mm
UB4N160M8S6	599351	160 mm	5 1/2"		M8	214 mm
UB4N168M8S6	599352	168 mm	6"	150	M8	224 mm
UB4N219M10S6	599354	219 mm	8"	200	M10	286 mm
UB4N273M10S6	599355	273 mm	10"	250	M10	331 mm
UB4N323M10S6	599356	323 mm	12"	300	M10	389 mm
Material: Steel – Finish: ElectroGalvanized						
UB4N017M6	599110	17 mm	3/8"	10	M6	42 mm
UB4N021M6	599120	21 mm	1/2"	15	M6	46 mm
UB4N027M8	599130	27 mm	3/4"	20	M8	58 mm
UB4N034M8	599140	34 mm	1"	25	M8	63 mm
UB4N042M8	599150	42 mm	1 1/4"	32	M8	76 mm
UB4N049M8	599160	49 mm	1 1/2"	40	M8	78 mm
UB4N060M8	599170	60 mm	2"	50	M8	88 mm
UB4N076M8	599180	76 mm	2 1/2"	65	M8	118 mm
UB4N090M8	599334	90 mm	3"	80	M8	125 mm
UB4N090M10	599190	90 mm	3"	80	M10	125 mm
UB4N114M10	599200	114 mm	4"	100	M10	166 mm
UB4N140M8	599337	140 mm	5"	125	M8	197 mm
UB4N160M8	599338	160 mm	5 1/2"		M8	214 mm
UB4N168M14	599240	168 mm	6"	150	M14	224 mm
UB4N219M10	599341	219 mm	8"	200	M10	286 mm
UB4N219M16	599250	219 mm	8"	200	M16	286 mm
UB4N273M16	599260	273 mm	10"	250	M16	331 mm
UB4N323M10	599343	323 mm	12"	300	M10	389 mm

Mechanical

PIPE EXPANSION PRODUCTS

PESHO HEAVY DUTY PIPE SLIDE, ONE CONNECTOR

- For use with one pipe clamp

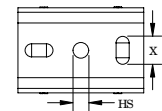
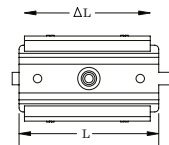
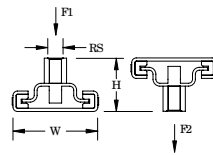
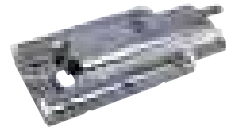

Material: Steel
Finish: Electrogalvanized

Part Number	Article Number	Rod Size	Height	Δ Length	Length	Width	Hole Size	X	Temperature	Static Load 1
PESHO	580564	M12, M16	51 mm	120 mm	150 mm	100 mm	12.5 mm	13 x 25 mm	240 °C Max	9,000 N

PESHOS HEAVY DUTY PIPE SLIDE WITH STRAP, ONE CONNECTOR

- For use with one pipe clamp
- Includes welded on mounting strap

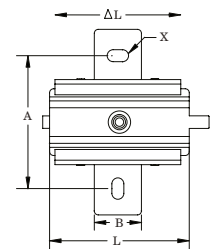
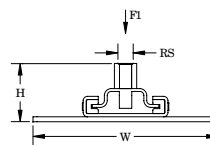
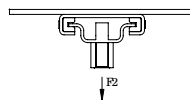

Material: Steel
Finish: Electrogalvanized

Part Number	Article Number	Rod Size	Height	Δ Length	Length	Width	A	B	X	Temperature
PESHOS	580565	M12, M16	57 mm	120 mm	150 mm	188 mm	160 mm	40 mm	13 x 25 mm	240 °C Max

Mechanical

PIPE EXPANSION PRODUCTS

PESHT HEAVY DUTY PIPE SLIDE, TWO CONNECTORS

- For use with two pipe clamps

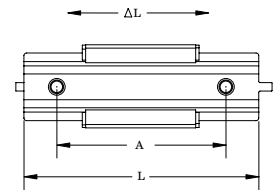
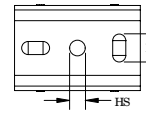
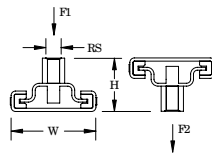
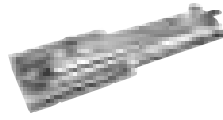

Material: Steel
Finish: Electrogalvanized

Part Number	Article Number	Rod Size	Hole Size	Height	Δ Length	Length	Width	A	X	Temperature
PESHT	580566	M12, M16	13 mm	51 mm	245 mm	275 mm	100 mm	210 mm	13 x 25 mm	240 °C Max

PESHTS HEAVY DUTY PIPE SLIDE WITH STRAP, TWO CONNECTORS

- For use with two pipe clamps
- Includes welded on mounting strap

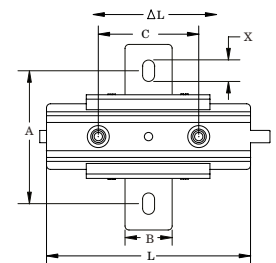
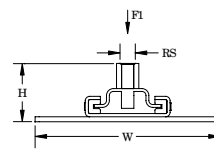
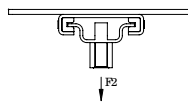

Material: Steel
Finish: Electrogalvanized

Part Number	Article Number	Rod Size	Height	Δ Length	Length	Width	A	B	C	X
PESHTS	580567	M12, M16	57 mm	245 mm	275 mm	188 mm	160 mm	40 mm	210 mm	13 x 25 mm

Mechanical

PIPE EXPANSION PRODUCTS

PESMO MEDIUM DUTY PIPE SLIDE, ONE CONNECTOR

- For use with one pipe clamp

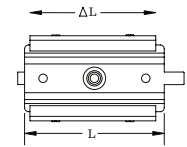
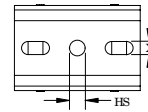
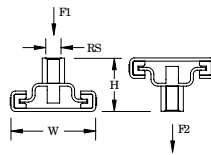

Material: Steel, Polyamide
Finish: Electrogalvanized

Part Number	Article Number	Rod Size	Hole Size	Height	Δ Length	Length	Width	X	Temperature	Static Load 1
PESMO	580560	M10, M12	12.5 mm	42 mm	80 mm	122 mm	67 mm	10.5 x 22 mm	120 °C Max	2,300 N

PESMOS MEDIUM DUTY PIPE SLIDE WITH STRAP, ONE CONNECTOR

- For use with one pipe clamp
- Includes welded on mounting strap

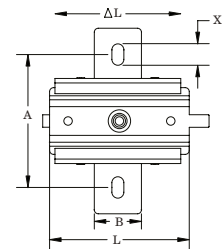
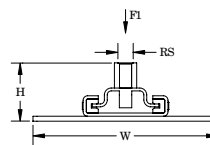
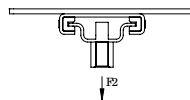

Material: Steel, Polyamide
Finish: Electrogalvanized

Part Number	Article Number	Rod Size	Height	Δ Length	Length	Width	A	B	X	Temperature
PESMOS	580561	M10, M12	46 mm	80 mm	122 mm	150 mm	100 mm	40 mm	12.5 x 20 mm	120 °C Max

Mechanical

PIPE EXPANSION PRODUCTS

PESMT MEDIUM DUTY PIPE SLIDE, TWO CONNECTORS

- For use with two pipe clamps

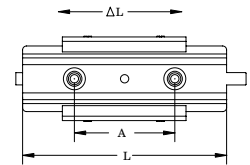
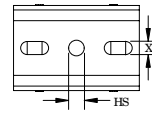
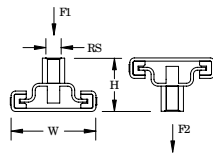
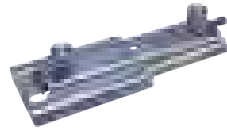

Material: Steel, Polyamide
Finish: Electrogalvanized

Part Number	Article Number	Rod Size	Hole Size	Height	Δ Length	Length	Width	A	X	Temperature
PESMT	580562	M10, M12	12.5 mm	42 mm	140 mm	165 mm	67 mm	123 mm	10.5 x 22 mm	120 °C Max

PESMTS, MEDIUM DUTY PIPE SLIDE WITH STRAP, TWO CONNECTORS

- For use with two pipe clamps
- Includes welded on mounting strap

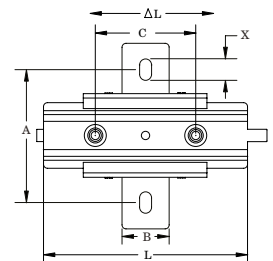
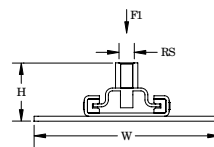
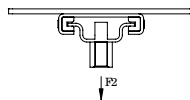

Material: Steel, Polyamide
Finish: Electrogalvanized

Part Number	Article Number	Rod Size	Height	Δ Length	Length	Width	A	B	C	X
PESMTS	580563	M10, M12	46 mm	140 mm	165 mm	150 mm	100 mm	40 mm	123 mm	12.5 x 20 mm

Mechanical

RADIATOR FIXINGS

PCG MEDIUM DUTY PIPE SLIDE



Material: Steel
Finish: Electrogalvanized

Part Number	Article Number	Rod Size	Δ Length	Temperature	Static Load
PCG	588170	M10	55 mm	-40 to 100 °C	1,500 N

DOME WASHER FOR OLD-STYLE RADIATOR

- Hollow cup washer for old style radiators



Material: Steel
Finish: Electrogalvanized

Part Number	Article Number	Hole Size
RADTOPWS	400816	9 mm

TOP BRACKET KIT FOR COLUMN RADIATOR

- Complete fixing bracket for old style radiators
- Embedded into the wall to stabilize radiator and prevent tilting
- Includes clamping plates and nuts



Material: Steel
Finish: Electrogalvanized

Part Number	Article Number	Length	Rod Size
RADTOP300EG	400812	300 mm	M8
RADTOP330EG	400813	330 mm	M8

Mechanical

PIPE INSULATION PRODUCTS

SIT CLIM INSULATED PIPE CLAMP WITH RUBBER ENDS

- Pre-mounted with steel two screw pipe clamp
- Fire rating B2 acc. to DIN 4102-1
- Fire rating M1 acc. to NFP 92-501

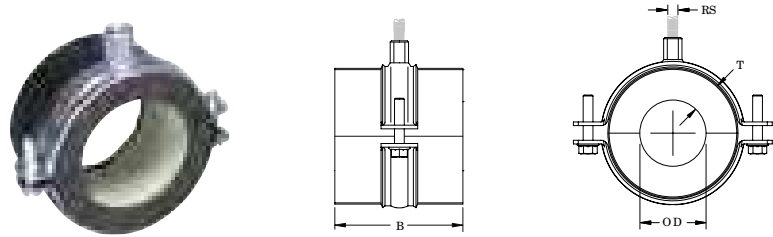

Material: Steel, Polyisocyanurate
 Finish: Electrogalvanized
 Density: 80 kg/m³
 Compressive Strength: 520 kPa @ 23 °C
 Thermal Conductivity: 0.030 W/m-K @ 10 °C

Part Number	Article Number	Outer Diameter	Pipe Size	NB/DN	Rod Size	B
Insulation Thickness: 13 mm						
SCL13I0010	580091	10.0 mm			M8, M10	50 mm
SCL13I0012	580092	12.0 mm			M8, M10	50 mm
SCL13I0016	580093	15.0 mm			M8, M10	50 mm
SCL13I0017	580100	17.0 mm	3/8"	10	M8, M10	50 mm
SCL13I0018	580105	18.0 mm			M8, M10	50 mm
SCL13I0021	580110	21.0 mm	1/2"	15	M8, M10	50 mm
SCL13I0022	580111	22.0 mm			M8, M10	50 mm
SCL13I0025	580112	25.0 mm			M8, M10	50 mm
SCL13I0027	580120	27.0 mm	3/4"	20	M8, M10	50 mm
SCL13I0028	580121	28.0 mm			M8, M10	50 mm
SCL13I0030	580122	30.0 mm			M8, M10	50 mm
SCL13I0034	580130	34.0 mm	1"	25	M8, M10	50 mm
SCL13I0035	580135	35.0 mm			M8, M10	50 mm
SCL13I0042	580140	42.0 mm	1 1/4"	32	M8, M10	50 mm
SCL13I0044	580145	44.5 mm			M8, M10	50 mm
SCL13I0049	580150	49.0 mm	1 1/2"	40	M8, M10	50 mm
SCL13I0054	580151	54.0 mm			M8, M10	50 mm
SCL13I0057	580152	58.0 mm			M8, M10	50 mm
SCL13I0060	580160	60.0 mm	2"	50	M8, M10	50 mm
SCL13I0064	580170	64.0 mm			M8, M10	50 mm
SCL13I0070	581600	70.0 mm			M8, M10	50 mm
SCL13I0076	581610	76.0 mm	2 1/2"	65	M8, M10	50 mm
SCL13I0089	581620	89.0 mm	3"	80	M8, M10	50 mm
SCL13I0102	581630	102.0 mm			M8, M10	50 mm
SCL13I0108	581640	108.0 mm			M8, M10	50 mm
SCL13I0114	581650	114.0 mm	4"	100	M8, M10	50 mm
Insulation Thickness: 19 mm						
SCL19I0010	580270	10.0 mm			M8, M10	50 mm
SCL19I0012	580280	12.0 mm			M8, M10	50 mm
SCL19I0016	580290	15.0 mm			M8, M10	50 mm
SCL19I0017	580300	17.0 mm	3/8"	10	M8, M10	50 mm
SCL19I0018	580305	18.0 mm			M8, M10	50 mm
SCL19I0021	580310	21.0 mm	1/2"	15	M8, M10	50 mm
SCL19I0022	580311	22.0 mm			M8, M10	50 mm
SCL19I0025	580312	25.0 mm			M8, M10	50 mm

Mechanical

PIPE INSULATION PRODUCTS

Part Number	Article Number	Outer Diameter	Pipe Size	NB/DN	Rod Size	B
SCLI19I0027	580320	27.0 mm	3/4"	20	M8, M10	50 mm
SCLI19I0028	580321	28.0 mm			M8, M10	50 mm
SCLI19I0030	580322	30.0 mm			M8, M10	50 mm
SCLI19I0034	580330	34.0 mm	1"	25	M8, M10	50 mm
SCLI19I0035	580335	35.0 mm			M8, M10	50 mm
SCLI19I0042	580340	42.0 mm	1 1/4"	32	M8, M10	50 mm
SCLI19I0044	580345	44.5 mm			M8, M10	50 mm
SCLI19I0049	580350	49.0 mm	1 1/2"	40	M8, M10	50 mm
SCLI19I0054	580351	54.0 mm			M8, M10	50 mm
SCLI19I0057	580352	57.0 mm			M8, M10	50 mm
SCLI19I0060	580360	60.0 mm	2"	50	M8, M10	50 mm
SCLI19I0064	580365	64.0 mm			M8, M10	50 mm
SCLI19I0070	581660	70.0 mm			M8, M10	50 mm
SCLI19I0076	581670	76.0 mm	2 1/2"	65	M8, M10	50 mm
SCLI19I0089	581680	89.0 mm	3"	80	M8, M10	50 mm
SCLI19I0102	581690	102.0 mm			M8, M10	50 mm
SCLI19I0108	581700	108.0 mm			M8, M10	50 mm
SCLI19I0114	581710	114.0 mm	4"	100	M8, M10	50 mm
SCLI19I0125	581715	125.0 mm			M8, M10	50 mm
SCLI19I0133	581720	133.0 mm			M8, M10	50 mm
SCLI19I0139	581725	139.7 mm	5"	125	M8, M10	50 mm
SCLI19I0160	581730	160.0 mm			M8, M10	50 mm
SCLI19I0168	581735	168.3 mm	6"	150	M8, M10	50 mm

Mechanical

VENTILATION

NVENT CADDY MACROFIX INSULATED VENTILATION DUCT CLAMP

- Complete hanger assembly comes out of the box ready to install (sizes up to 600 mm)
- Increased opening angle easily accommodates all standard-sized spiral ducts (sizes up to 600 mm)
- Quick locking system prevents the hanger from accidentally opening when duct is moved or adjusted (sizes up to 600 mm)
- Quick locking system easily closes with one hand (sizes up to 600 mm)
- Thread impression retains quick locking captive screw and prevents it from falling out during installation
- Return-lip on the hanger prevents the rubber from detaching, eliminating rework during installation
- Combo head bolt works with slotted, hex, or Phillips drivers
- Longer ears position the screw farther from the hanger, improving tool clearance when the screw is tightened
- Combination nut can be attached to M8 or M10 threaded rod, simplifying material handling
- Category II noise reduction according to DIN EN ISO 3822-1
- Compliant for sound insulation design according to DIN 4109
- Reaction-to-fire classification is "E" in compliance with DIN EN 13501-1:2010-01

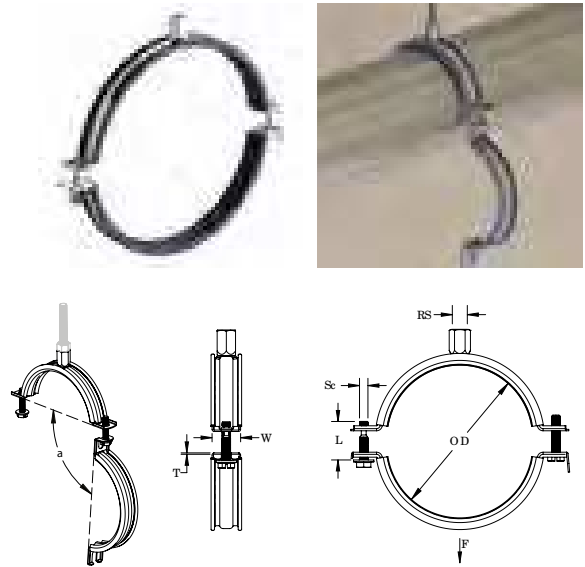

Material: EPDM-SBR Rubber, Steel
 Finish: Electrogalvanized
 Temperature: -50 to 110 °C

Part Number	Article Number	Outer Diameter	Rod Size	Width	Thickness	Screw Diameter	Screw Length	Angle	Static Load
MFVI0080EG	586601	80 mm	M8, M10	20 mm	1.00 mm	M6	27 mm	80°	750 N
MFVI0090EG	586602	90 mm	M8, M10	20 mm	1.00 mm	M6	27 mm	80°	750 N
MFVI0100EG	586603	100 mm	M8, M10	20 mm	1.00 mm	M6	27 mm	80°	750 N
MFVI0112EG	586604	112 mm	M8, M10	20 mm	1.00 mm	M6	27 mm	80°	750 N
MFVI0125EG	586605	125 mm	M8, M10	20 mm	1.00 mm	M6	27 mm	80°	750 N
MFVI0140EG	586606	140 mm	M8, M10	20 mm	1.00 mm	M6	27 mm	80°	750 N
MFVI0150EG	586607	150 mm	M8, M10	20 mm	1.00 mm	M6	27 mm	80°	750 N
MFVI0160EG	586608	160 mm	M8, M10	20 mm	1.00 mm	M6	27 mm	80°	750 N
MFVI0180EG	586609	180 mm	M8, M10	20 mm	1.00 mm	M6	27 mm	80°	750 N
MFVI0200EG	586610	200 mm	M8, M10	20 mm	1.00 mm	M6	27 mm	80°	750 N
MFVI0224EG	586611	224 mm	M8, M10	21 mm	1.25 mm	M6	27 mm	80°	750 N
MFVI0250EG	586612	250 mm	M8, M10	21 mm	1.25 mm	M6	27 mm	80°	750 N
MFVI0280EG	586613	280 mm	M8, M10	21 mm	1.25 mm	M6	27 mm	80°	750 N
MFVI0300EG	586614	300 mm	M8, M10	21 mm	1.25 mm	M6	27 mm	80°	750 N
MFVI0315EG	586615	315 mm	M8, M10	21 mm	1.25 mm	M6	27 mm	80°	750 N
MFVI0355EG	586616	355 mm	M8, M10	21 mm	1.25 mm	M6	27 mm	80°	750 N
MFVI0400EG	586617	400 mm	M8, M10	21 mm	1.25 mm	M6	27 mm	80°	750 N
MFVI0450EG	586618	450 mm	M8, M10	21 mm	1.50 mm	M6	27 mm	80°	900 N
MFVI0500EG	586619	500 mm	M8, M10	21 mm	1.50 mm	M6	27 mm	80°	900 N
MFVI0560EG	586620	560 mm	M8, M10	21 mm	1.50 mm	M6	27 mm	80°	900 N
MFVI0600EG	586621	600 mm	M8, M10	21 mm	1.50 mm	M6	27 mm	80°	900 N
MFVI0630EG	586622	630 mm	M8, M10	23 mm	1.75 mm	M6	27 mm		1,150 N
MFVI0710EG	586623	710 mm	M8, M10	23 mm	1.75 mm	M6	27 mm		1,150 N
MFVI0800EG	586624	800 mm	M8, M10	23 mm	1.75 mm	M6	27 mm		1,150 N
MFVI0900EG	586625	900 mm	M8, M10	23 mm	1.75 mm	M6	27 mm		1,150 N
MFVI1000EG	586626	1,000 mm	M8, M10	23 mm	2.00 mm	M6	27 mm		1,400 N
MFVI1120EG	586627	1,120 mm	M8, M10	23 mm	2.00 mm	M6	27 mm		1,400 N
MFVI1250EG	586628	1,250 mm	M8, M10	23 mm	2.00 mm	M6	27 mm		1,400 N

Mechanical

VENTILATION

nVENT CADDY MACROFIX NON-INSULATED VENTILATION DUCT CLAMP

- Complete hanger assembly comes out of the box ready to install (sizes up to 600 mm)
- Increased opening angle easily accommodates all standard-sized spiral ducts (sizes up to 600 mm)
- Quick locking system prevents the hanger from accidentally opening when duct is moved or adjusted (sizes up to 600 mm)
- Quick locking system easily closes with one hand (sizes up to 600 mm)
- Thread impression retains quick locking captive screw and prevents it from falling out during installation
- Combo head bolt works with slotted, hex, or Phillips drivers
- Longer ears position the screw farther from the hanger, improving tool clearance when the screw is tightened
- Combination nut can be attached to M8 or M10 threaded rod, simplifying material handling

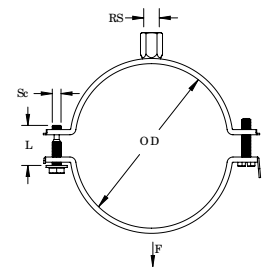
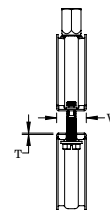
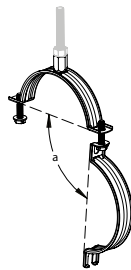

Material: Steel
 Finish: Electrogalvanized
 Temperature: -50 to 110 °C

Part Number	Article Number	Outer Diameter	Rod Size	Width	Thickness	Screw Diameter	Screw Length	Angle	Static Load
MFVN0080EG	586501	80 mm	M8, M10	20 mm	1.00 mm	M6	27 mm	80°	750 N
MFVN0090EG	586502	90 mm	M8, M10	20 mm	1.00 mm	M6	27 mm	80°	750 N
MFVN0100EG	586503	100 mm	M8, M10	20 mm	1.00 mm	M6	27 mm	80°	750 N
MFVN0112EG	586504	112 mm	M8, M10	20 mm	1.00 mm	M6	27 mm	80°	750 N
MFVN0125EG	586505	125 mm	M8, M10	20 mm	1.00 mm	M6	27 mm	80°	750 N
MFVN0140EG	586506	140 mm	M8, M10	20 mm	1.00 mm	M6	27 mm	80°	750 N
MFVN0150EG	586507	150 mm	M8, M10	20 mm	1.00 mm	M6	27 mm	80°	750 N
MFVN0160EG	586508	160 mm	M8, M10	20 mm	1.00 mm	M6	27 mm	80°	750 N
MFVN0180EG	586509	180 mm	M8, M10	20 mm	1.00 mm	M6	27 mm	80°	750 N
MFVN0200EG	586510	200 mm	M8, M10	20 mm	1.00 mm	M6	27 mm	80°	750 N
MFVN0224EG	586511	224 mm	M8, M10	21 mm	1.25 mm	M6	27 mm	80°	750 N
MFVN0250EG	586512	250 mm	M8, M10	21 mm	1.25 mm	M6	27 mm	80°	750 N
MFVN0280EG	586513	280 mm	M8, M10	21 mm	1.25 mm	M6	27 mm	80°	750 N
MFVN0300EG	586514	300 mm	M8, M10	21 mm	1.25 mm	M6	27 mm	80°	750 N
MFVN0315EG	586515	315 mm	M8, M10	21 mm	1.25 mm	M6	27 mm	80°	750 N
MFVN0355EG	586516	355 mm	M8, M10	21 mm	1.25 mm	M6	27 mm	80°	750 N
MFVN0400EG	586517	400 mm	M8, M10	21 mm	1.25 mm	M6	27 mm	80°	750 N
MFVN0450EG	586518	450 mm	M8, M10	21 mm	1.50 mm	M6	27 mm	80°	900 N
MFVN0500EG	586519	500 mm	M8, M10	21 mm	1.50 mm	M6	27 mm	80°	900 N
MFVN0560EG	586520	560 mm	M8, M10	21 mm	1.50 mm	M6	27 mm	80°	900 N
MFVN0600EG	586521	600 mm	M8, M10	21 mm	1.50 mm	M6	27 mm	80°	900 N
MFVN0630EG	586522	630 mm	M8, M10	23 mm	1.75 mm	M6	27 mm		1,150 N
MFVN0710EG	586523	710 mm	M8, M10	23 mm	1.75 mm	M6	27 mm		1,150 N
MFVN0800EG	586524	800 mm	M8, M10	23 mm	1.75 mm	M6	27 mm		1,150 N
MFVN0900EG	586525	900 mm	M8, M10	23 mm	1.75 mm	M6	27 mm		1,150 N
MFVN1000EG	586526	1,000 mm	M8, M10	23 mm	2.00 mm	M6	27 mm		1,400 N
MFVN1120EG	586527	1,120 mm	M8, M10	23 mm	2.00 mm	M6	27 mm		1,400 N
MFVN1250EG	586528	1,250 mm	M8, M10	23 mm	2.00 mm	M6	27 mm		1,400 N

Mechanical

VENTILATION

H-MSS INLINE STRAP HANGER WITH FLANGE CLIP

- Supports pipe or duct from flange with banding or strapping

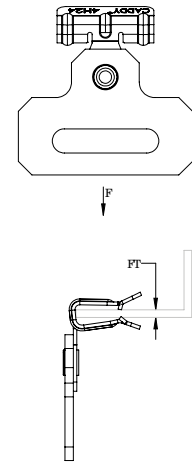

Material: Steel, Spring Steel
Finish: nVent CADDY Armour, Pregalvanized

Part Number	Article Number	Flange Thickness	Strap Width	Static Load	Certifications
MSS24	172030	3 – 8 mm	32 mm Max	900 N	ITB
MSS58	171760	8 – 14 mm	32 mm Max	900 N	ITB
MSS912	171770	14 – 20 mm	32 mm Max	900 N	ITB

ABP PERFORATED STRAP WITH ROUNDED EDGE, STANDARD DUTY

- Steel perforated mounting strap
- Enclosed in plastic case

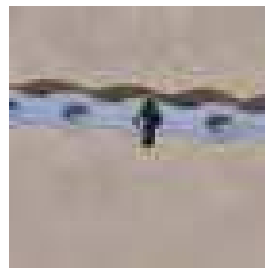

Part Number	Article Number	Width	Length	Thickness	Hole Size	Static Load
Material: Stainless Steel 304 (EN 1.4301)						
ABP12S4	584020	12 mm	10 m	0.8 mm	5 mm	700 N
Material: Steel – Finish: Pregalvanized						
ABP12PG	583920	12 mm	10 m	0.8 mm	5 mm	560 N
ABP17PG	583930	17 mm	10 m	0.8 mm	7 mm	800 N
ABP26PG	583940	26 mm	10 m	1.0 mm	8 mm	1,800 N

Mechanical

VENTILATION

BP PERFORATED STRAP WITH STRAIGHT EDGE, LIGHT DUTY

- Strapping to support cable or conduit runs

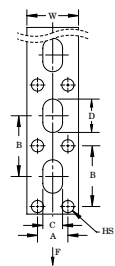
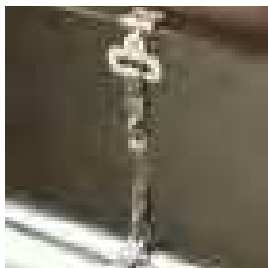

Material: Steel
Finish: Pregalvanized

Part Number	Article Number	Width	Thickness	Hole Size	A	B	C	D	Static Load
BP17PG	591350	17 mm	0.6 mm	3 mm	10 mm	20 mm	6.5 mm	11 mm	500 N
BP25PG	591360	25 mm	0.8 mm	4 mm	15 mm	33 mm	8.5 mm	21 mm	750 N

SBP PERFORATED STRAP WITH STRAIGHT EDGE, STANDARD DUTY

- Enclosed in plastic case

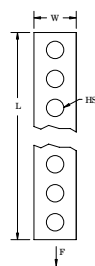

Material: Steel
Finish: Pregalvanized

Part Number	Article Number	Width	Length	Thickness	Hole Size	Static Load
SBP17	400429	17 mm	10 m	1 mm	6.5 mm	800 N

Mechanical

VENTILATION

SBP-C PERFORATED STRAP WITH STRAIGHT EDGE, PLASTIC COATED

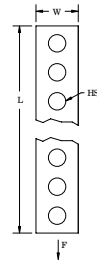
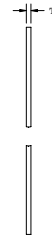
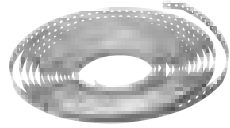

Material: Steel, Polyvinylchloride
Finish: Pregalvanized

Part Number	Article Number	Width	Length	Thickness	Hole Size	Static Load
SBPC19	400430	19 mm	10 m	3 mm	6.5 mm	750 N

EQLS SQUARE DUCT FIXING WITH SOUND REDUCER, L-SHAPE

- Includes hole for pop-riev connection

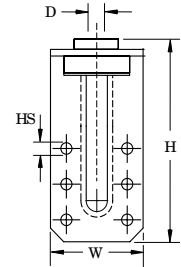
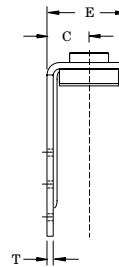

Material: Steel, EPDM-SBR Rubber
Finish: Electrogalvanized

Part Number	Article Number	Height	Hole Size	Width	Thickness	C	D	E
EQLS50	597791	50 mm	4.2 mm	35 mm	2 mm	24 mm	8.4 mm	40 mm
EQLS85	597780	85 mm	4.2 mm	35 mm	2 mm	24 mm	8.4 mm	40 mm
EQLS130	597792	130 mm	4.2 mm	35 mm	2 mm	24 mm	8.4 mm	40 mm

EQZS SQUARE DUCT FIXING WITH SOUND REDUCER, Z-SHAPE

- Includes hole for pop-riev connection

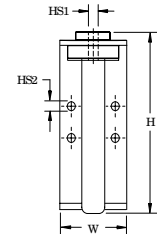
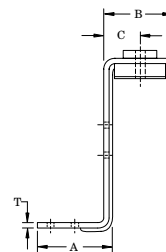

Material: Steel, EPDM-SBR Rubber
Finish: Electrogalvanized

Part Number	Article Number	Hole Size 1	Hole Size 2	Height	Width	Thickness	A	B	C
EQZS	597790	8.4 mm	4.2 mm	60 mm	35 mm	2 mm	32 mm	37 mm	20 mm

Mechanical

VENTILATION

EQVS ROUND DUCT FIXING WITH SOUND REDUCER, V-SHAPE

- Includes holes for pop-rivet connection

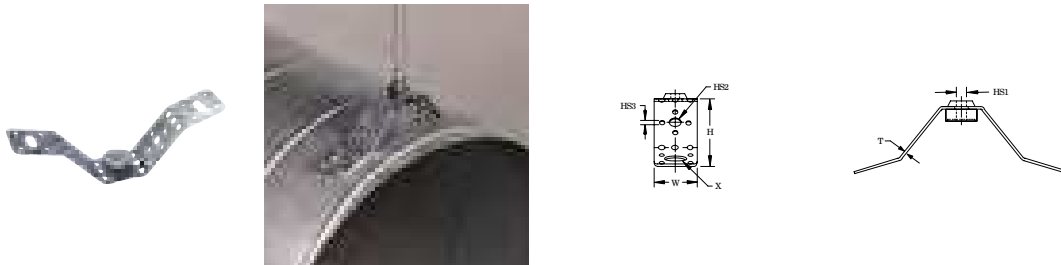

Material: Steel, EPDM-SBR Rubber
Finish: Electrogalvanized

Part Number	Article Number	Hole Size 1	Hole Size 2	Hole Size 3	Height	Width	Thickness	X
EQVS	597770	8.5 mm	8.5 mm	4.2 mm	60 mm	40 mm	2 mm	8.5 x 20 mm

TBHS BENDABLE ROUND DUCT FIXING WITH SOUND REDUCER, V-SHAPE

- Includes holes for pop-rivet connection

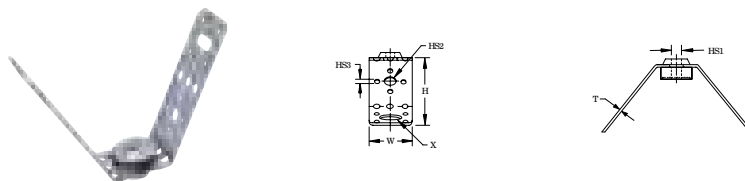

Material: Steel, EPDM-SBR Rubber
Finish: Electrogalvanized

Part Number	Article Number	Hole Size 1	Hole Size 2	Hole Size 3	Height	Width	Thickness	X
TBHS	597575	8.4 mm	8.5 mm	4.2 mm	95 mm	40 mm	2 mm	8.5 x 20 mm

SIGN SUPPORT BRACKET FOR ROUND POLE, ONE HOLE

- Flared leg design provides a secure fit, locking each leg in place
- Attachment support for Fixoband
- Stainless steel washers and bolts included



Material: Stainless Steel 302 (EN 1.4324)

Part Number	Article Number	Hole Size	Hole Type	A
FXB20S2	350100	M8	Threaded	20 mm

Mechanical

SIGN AND NAME PLATE SYSTEMS

SIGN SUPPORT BRACKET FOR FLAT SURFACE, ONE HOLE

- Straight leg design, should be used when mounting on a flat surface
- Attachment support for Fixoband
- Stainless steel washers and bolts included

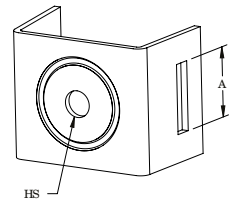

Material: Stainless Steel 302 (EN 1.4324)

Part Number	Article Number	Hole Size	Hole Type	A
FXB21S2	350110	M8	Threaded	20 mm

SIGN SUPPORT BRACKET FOR ROUND POLE, TWO HOLE

- Flared leg design provides a secure fit, locking each leg in place
- Attachment support for Fixoband
- Stainless steel washers and bolts included

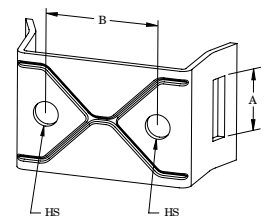

Material: Stainless Steel 302 (EN 1.4324)

Part Number	Article Number	Hole Size	Hole Type	A	B
FXB22S2	350120	M8	Threaded	20 mm	38 mm

SIGN SUPPORT BRACKET FOR FLAT SURFACE, TWO HOLE

- Straight leg design, should be used when mounting on a flat surface
- Attachment support for Fixoband
- Stainless steel washers and bolts included

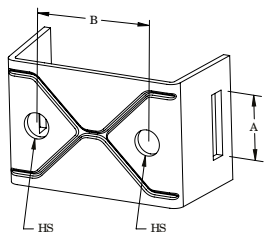

Material: Stainless Steel 302 (EN 1.4324)

Part Number	Article Number	Hole Size	Hole Type	A	B
FXB23S2	350130	M8	Threaded	20 mm	38 mm

Mechanical

SIGN AND NAME PLATE SYSTEMS

SIGN SUPPORT BRACKET WITH SLOTTED HOLES

- Attachment support for Fixoband

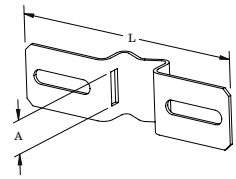

Material: Stainless Steel 302 (EN 1.4324)

Part Number	Article Number	Length	A
FXB24S2	350140	140 mm	20 mm
FXB25S2	350150	90 mm	20 mm

HEAVY DUTY STRAP BUCKLE

- Clip to secure Fixoband strapping
- For strapped looped in single or double layer

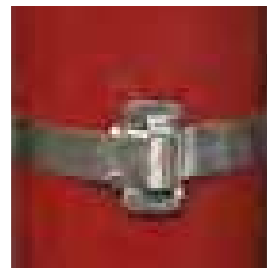
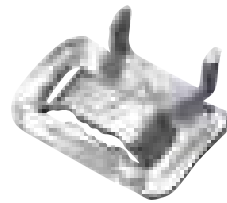

Material: Stainless Steel 302 (EN 1.4324)

Part Number	Article Number	Strap Width
FXBB10S2	591250	10.0 mm
FXBB12S2	591260	12.7 mm
FXBB16S2	591270	16.0 mm
FXBB20S2	591280	20.0 mm

STANDARD DUTY STRAP BUCKLE

- L Clip to secure Fixoband strapping

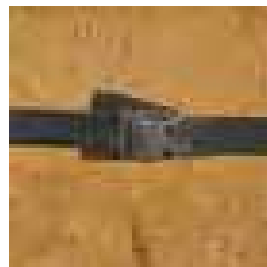

Material: Stainless Steel 302 (EN 1.4324)

Part Number	Article Number	Strap Width
FXBC10S2	591070	10 mm
FXBC20S2	591080	20 mm

Mechanical

SIGN AND NAME PLATE SYSTEMS

STRAP TENSIONING TOOL

- Banding tensioning tool
- Stainless steel banding, stainless steel serrated buckle and stainless buckle sold separately

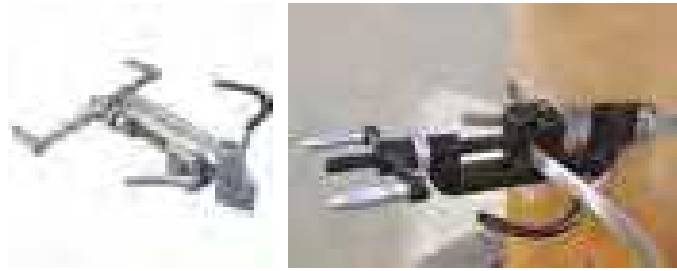

Material: Stainless Steel 304 (EN 1.4301)

Part Number	Article Number
FXBTOOL	591290

METAL STRAP

- Provides variable fastening on poles, masts and pipes

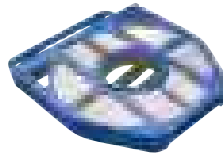

Material: Stainless Steel 302 (EN 1.4324)

Part Number	Article Number	Strap Width	Thickness
FXBF10X50MS2	591200	10.0 mm	0.7 mm
FXBF12X50MS2	591210	12.7 mm	0.7 mm
FXBF16X50MS2	591220	16.0 mm	0.7 mm
FXBF20X50MS2	591230	20.0 mm	0.7 mm

ESS UHS SIGN HOLDER SYSTEM WITH STRAP

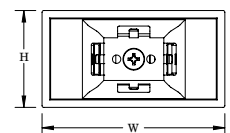
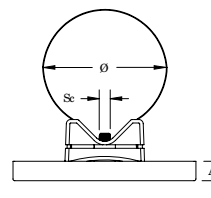
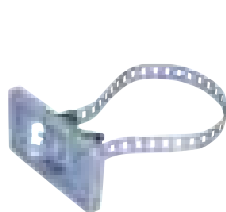

Material: Steel, Polycarbonate
Finish: Pregalvanized

Part Number	Article Number	Screw Diameter	Diameter	Height	Width	A
ESSUHS	599500	M8	76 mm Max	55 mm	105 mm	11 mm

Mechanical

SIGN AND NAME PLATE SYSTEMS

ESS UH SIGN HOLDER SYSTEM WITHOUT STRAP

- Attached clip accepts ESS ST Strap for fixing to pipe

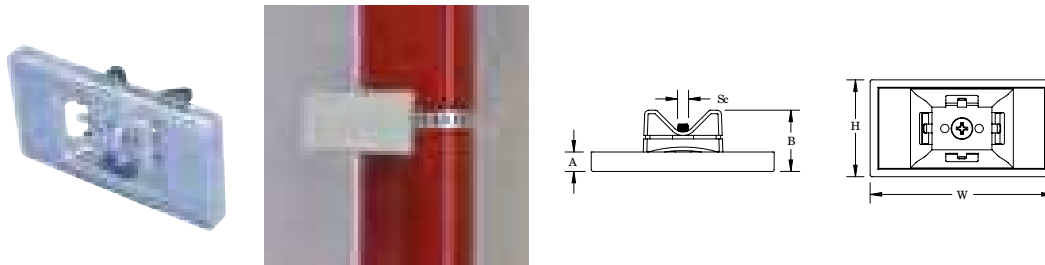

Material: Steel, Polycarbonate
Finish: Pregalvanized

Part Number	Article Number	Screw Diameter	Height	Width	A	B
ESSUH	599501	M8	55 mm	105 mm	11 mm	36 mm

ESS ST STRAP

- Steel strap for use with ESS UH name plate holder

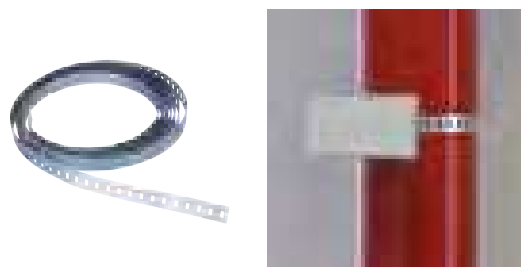

Material: Steel
Finish: Pregalvanized

Part Number	Article Number	Length
ESSST	599504	5 m

SBFF FEMALE-FEMALE SOUND INSULATOR

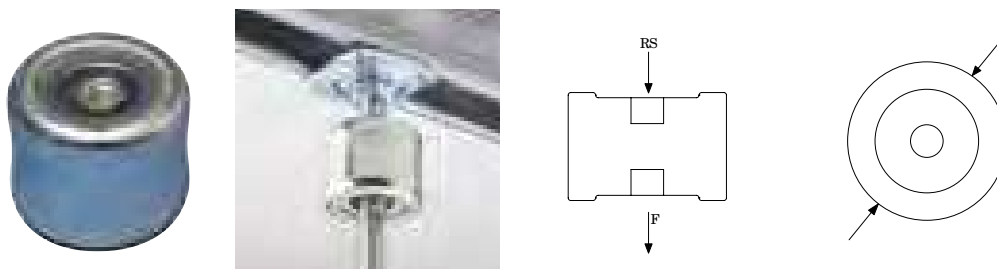

Material: Steel, EPDM-SBR Rubber
Finish: Electrogalvanized

Part Number	Article Number	Diameter	Rod Size	Static Load
ISOFO8F08EG	588440	39 mm	M8	1,500 N

Mechanical

SOUND AND VIBRATION INSULATORS

SBFK FEMALE-FEMALE COMPRESSION INSULATOR

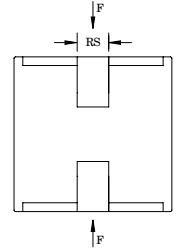
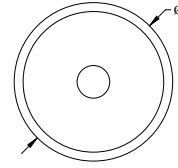

Material: Steel
Finish: Electrogalvanized

Part Number	Article Number	Diameter	Rod Size	Static Load
SBFKM8	588620	40 mm	M8	600 N

SBMF MALE-FEMALE SOUND INSULATOR

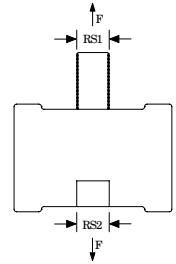
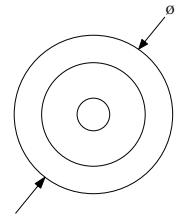

Material: Steel, EPDM-SBR Rubber
Finish: Electrogalvanized

Part Number	Article Number	Diameter	Rod Size 1	Rod Size 2	Static Load
ISOF08M08EG	588560	39 mm	M8	M8	1,500 N
ISOF10M10EG	588580	39 mm	M10	M10	1,500 N

SBMK MALE-MALE COMPRESSION INSULATOR

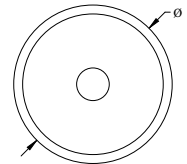
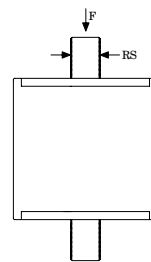

Material: Steel, EPDM-SBR Rubber
Finish: Electrogalvanized

Part Number	Article Number	Diameter	Rod Size	Static Load
SBMKM10	588630	40 mm	M10	600 N
SBMKM8	588610	40 mm	M8	600 N

Mechanical

SOUND AND VIBRATION INSULATORS

SGBC HEAVY DUTY SOUND INSULATOR

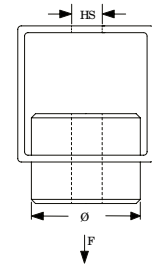

Material: Steel
Finish: Electrogalvanized

Part Number	Article Number	Diameter	Hole Size	Static Load
ISOHD16EG	588500	80 mm	18.3 mm	7,000 N

IHT HIGH-TEMPERATURE SOUND INSULATION RUBBER

- Suitable for installation in pipe clamps or metal strap

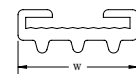
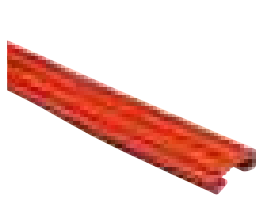

Material: Silicon Rubber
Color: Red
Temperature: -40 to 220 °C

Part Number	Article Number	Width	Length
IHT20	578680	20 mm	30 m
IHT30	578695	30 mm	30 m

SOUND INSULATION RUBBER FOR STRUT PIPE CLAMPS

- For use in strut pipe clamps
- Suitable for high temperatures

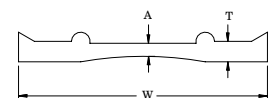
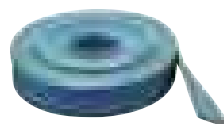

Material: EPDM-SBR Rubber

Part Number	Article Number	Length	Width	Thickness	A	Temperature
VS200000	402268	6 m	42.7 mm	3.2 mm	2.2 mm	-45 to 145 °C

10. Bracing Systems



nVent CADDY Seismic Bracing Systems Overview

nVent CADDY Seismic Solutions protect people, property and equipment during and after a seismic event by ensuring business continuity and continued operation of critical infrastructure and services.

Areas of nVent CADDY expertise:

- Designing a complete, right-sized bracing system
- Identifying the appropriate product from our broad offering
- Offering compatible attachment and support products
- Explaining installation techniques and tips to meet evolving codes and standards requirements

From design to construction to inspection, the nVent CADDY team makes seismic simple by walking you through the full process for applications including Mechanical, HVAC, Electrical, Plumbing and Fire Protection.

Both cable and rigid bracing solutions are available for single pipe or conduit, trapeze, and for floor-, roof-, and wall-mounted equipment.

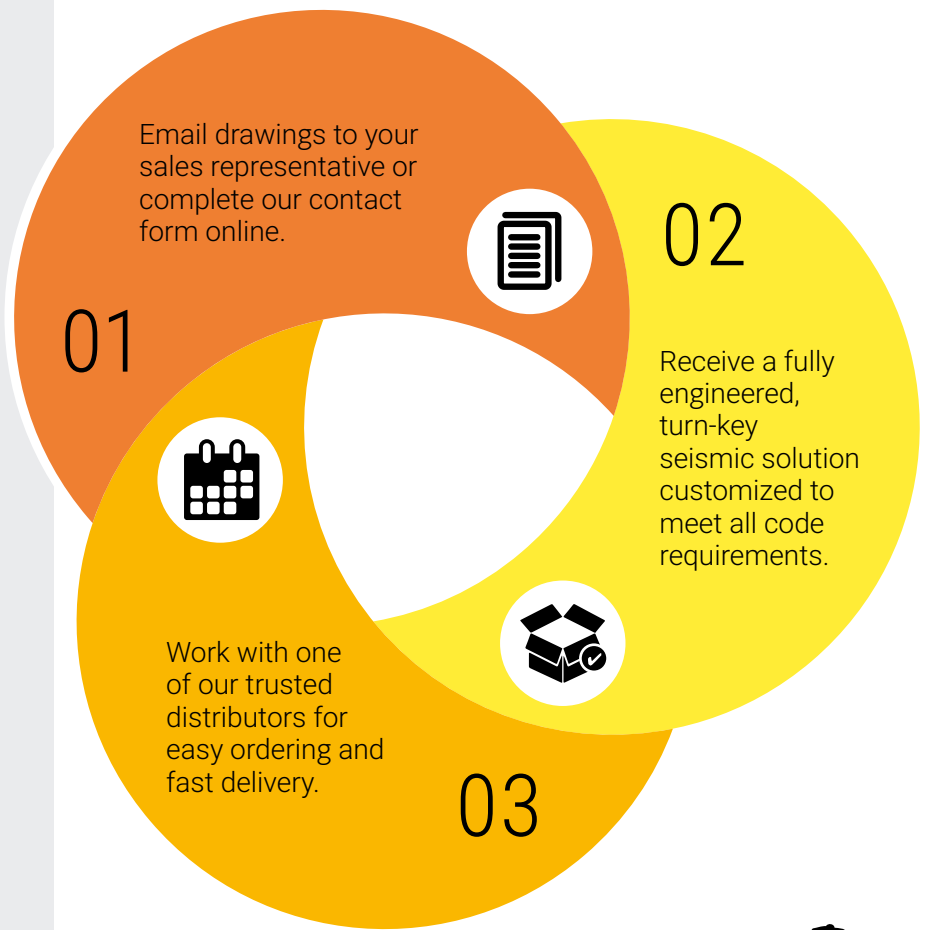

WE MAKE
SEISMIC
SIMPLE

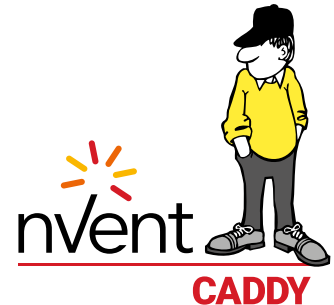

ENGINEERING SOLUTIONS

- Design optimization to meet your needs
- Bracing layouts with bill of material with code compliant products
- Stamped drawings

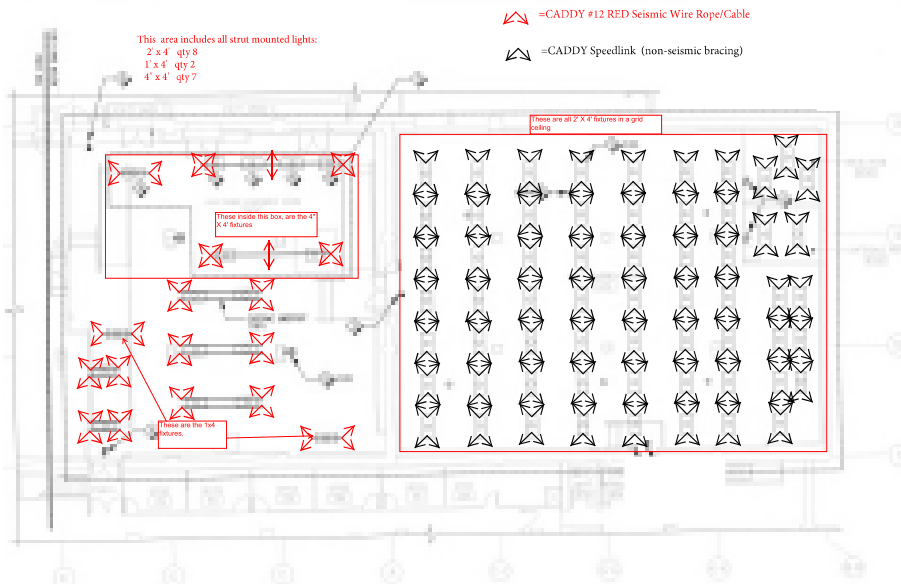

“nVent’s seismic experts provide everything we need for a code compliant cable bracing system. Their patented, turn-key seismic solutions give us peace of mind that our building products are properly braced for a seismic event.”

Tim Barmeier
Mechanical Supply Company

PRODUCT SOLUTIONS

- Cable and rigid bracing solutions
- Innovative products
- Superior full range of bracing solutions

CUSTOMER EXPERIENCE

- Quick turnaround
- Local availability through distributors
- In-market support from the local nVent CADDY sales team



Seismic Bracing Systems

RIGID BRACING

BAR JOIST ATTACHMENT

- Can be installed on bar joists or I-beams
- Thumb spring retainer allows for ease of positioning
- Snap-off bolt head helps enable easy installation and inspection of seismic sway braces
- No assembly required
- No loose parts
- Meets NFPA®-13 requirements for seismic sway bracing

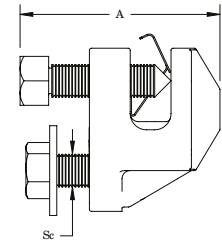
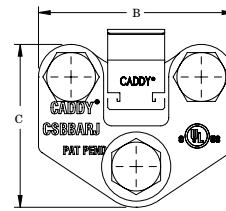
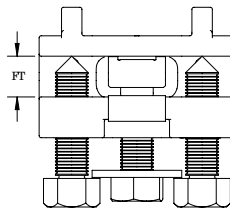
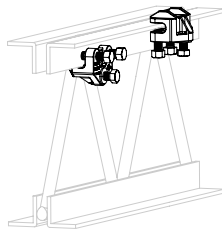
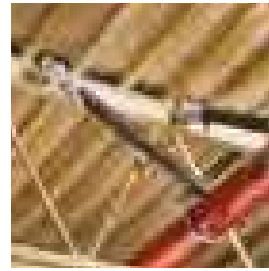

Material: Steel
Finish: Electrogalvanized



Part Number	Article Number	Flange Thickness	Screw Diameter	A	B	C
CSBBARJEG	404354	6.4 – 12.7 mm	1/2"	50.8 mm	76.2 mm	63.5 mm

UL Loads		
Brace Direction to Structure	Service Pipe Size	Rating
Parallel	25 - 250 mm	13340 N
Perpendicular	25 - 300 mm	16630 N

FM Loads					
Brace Direction	Service Pipe Size	Horizontal Capacity per Intallation Angle from Vertical			
		30° - 44°	45° - 59°	60° - 74°	75° - 90°
Parallel	N/A	6270 N	9385 N	11300 N	12590 N
Perpendicular	N/A	7740 N	7605 N	9165 N	10230 N

Seismic Bracing Systems

RIGID BRACING

ADJUSTABLE I-BEAM ATTACHMENT

- No loose parts
- No assembly required
- Snap-off bolt head helps enable easy installation and inspection of seismic sway braces
- Meets NFPA®-13 requirements for seismic sway bracing

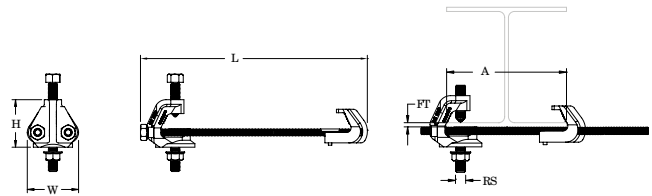

Material: Steel
Finish: Electrogalvanized



Part Number	Article Number	Flange Thickness	Rod Size	A	Height	Length	Width
CSBIB075085EG	404365	6.4 – 19.1 mm	1/2"	100 – 216 mm	63.5 mm	304.8 mm	69.9 mm
CSBIB075145EG	404366	6.4 – 19.1 mm	1/2"	216 – 368 mm	63.5 mm	431.8 mm	69.9 mm
CSBIB125180EG	404367	19.1 – 31.8 mm	1/2"	100 – 457 mm	88.9 mm	546.1 mm	79.4 mm

UL Loads		
Brace Direction to Structure	Service Pipe Size	Rating
Parallel	25 - 300 mm	16630 N
Perpendicular	25 - 300 mm	16630 N

FM Loads					
Brace Direction	Service Pipe Size	Horizontal Capacity per Intallation Angle from Vertical			
		30° - 44°	45° - 59°	60° - 74°	75° - 90°
Parallel	N/A	7,205 N	7,605 N	4,495 N	4,940 N
Perpendicular	N/A	7,205 N	10,230 N	12,545 N	13,965 N

Seismic Bracing Systems

RIGID BRACING

I-BEAM ATTACHMENT

- Snap-off bolt head helps enable easy installation and inspection of seismic sway braces
- Meets NFPA®-13 requirements for seismic sway bracing

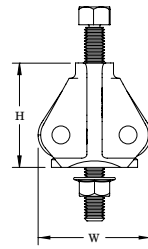
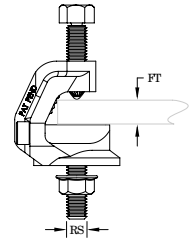

Material: Steel
Finish: Electrogalvanized



Part Number	Article Number	Flange Thickness	Rod Size	Height	Width
CSBBC075EG	404350	6.4 – 19.1 mm	1/2"	63.5 mm	69.9 mm

UL Loads		
Brace Direction to Structure	Service Pipe Size	Rating
Parallel	1" - 4"	5,340 N
Perpendicular	1" - 8"	8,960 N

FM Loads					
Brace Direction to Structure	Service Pipe Size	Horizontal Capacity per Intallation Angle from Vertical			
		30° - 44°	45° - 59°	60° - 74°	75° - 90°
Parallel	N/A	7,210 N	7,610 N	4,490 N	4,940 N
Perpendicular	N/A	5,290 N	7,470 N	5,160 N	5,690 N

Seismic Bracing Systems

RIGID BRACING

MULTI ATTACHMENT

- Disperses load over two anchors
- Minimizes the number of installed braces needed for concrete and wood structures
- Ideal for deck installations
- Use for both lateral and longitudinal sway brace applications
- Meets NFPA®-13 requirements for seismic sway bracing

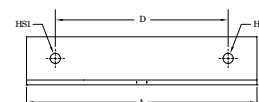
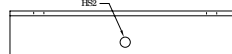
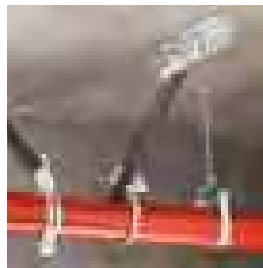

Material: Steel
Finish: Electrogalvanized



Part Number	Article Number	Hole Size 1	Hole Size 2	A	B	C	D	UL Listed Load
CSBMA050050EG	404371	14 mm	14 mm	304.8 mm	63.5 mm	63.5 mm	228.6 mm	16,636 N
CSBMA050075EG	404372	20 mm	14 mm	304.8 mm	63.5 mm	63.5 mm	228.6 mm	16,636 N

Mount to structure using holes indicated in HS1.

UL Loads

Part Number	Service Pipe Size	Rating
CSBMA050050EG	25 - 300 mm	15,435 N
CSBMA050075EG	25 - 300 mm	15,435 N

FM Loads

Part Number	Horizontal Capacity per Intallation Angle from Vertical			
	30° - 44°	45° - 59°	60° - 74°	75° - 90°
CSBMA050050EG	14,630 N	20,100 N	24,640 N	27,570 N
CSBMA050075EG	14,630 N	20,100 N	24,640 N	27,570 N

STRUT SEISMIC HINGE

- Complete hinge assembly
- Ideal for attaching sway bracing to MEP system supports
- Attaches to strut trapezes and to structure

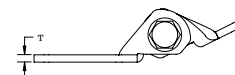
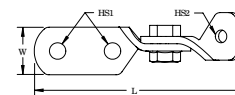

Material: Steel
Finish: Electrogalvanized

Part Number	Article Number	Hole Size 1	Hole Size 2	Length	Width	Thickness
CSBSH00375EG	404463	14 mm	11 mm	179.8 mm	41.3 mm	6.4 mm
CSBSH00500EG	404464	14 mm	14 mm	179.8 mm	41.3 mm	6.4 mm
CSBSH00625EG	404465	14 mm	17 mm	179.8 mm	41.3 mm	6.4 mm
CSBSH00750EG	404466	14 mm	21 mm	179.8 mm	41.3 mm	6.4 mm

Seismic Bracing Systems

RIGID BRACING

UNIVERSAL STRUCTURAL ATTACHMENT

- Universal design allows one product to attach directly to concrete, wood, bar joist or I-beam adapters
- Snap-off bolt head helps enable easy installation and inspection of seismic sway braces
- Use for both lateral and longitudinal sway brace applications
- Works with 1" through 2" brace pipes and 1/4" angle iron braces to reduce inventory
- Center bolt does not require tightening
- Meets NFPA®-13 requirements for seismic sway bracing

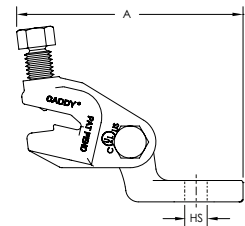
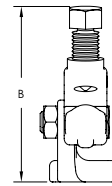
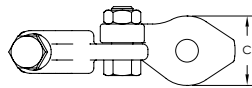

Material: Steel
Finish: Electrogalvanized



Part Number	Article Number	Hole Size	A	B	C
CSBUNIV050EG	404407	14 mm	133.4 mm	101.6 mm	41.4 mm
CSBUNIV075EG	404409	21 mm	133.4 mm	101.6 mm	41.4 mm

UL Loads		
Brace Type	Service Pipe Size	Rating
Pipe	25 mm - 250 mm	13,340 N
6mm Thick Angle	25 mm - 200 mm	8,960 N

FM Loads					
Brace Type	Service Pipe Size	Horizontal Capacity per Installation Angle from Vertical			
		30° - 44°	45° - 59°	60° - 74°	75° - 90°
Pipe	N/A	7,205 N	10,230 N	12,545 N	13,965 N

Seismic Bracing Systems

RIGID BRACING

CONE POINT SHEAR BOLT



Material: Steel
Finish: Electrogalvanized

Part Number	Article Number	Product
CSBBARJSB50EG	402502	Bar Joist Attachment
CSBIBSB50EG	402501	I-Beam Attachment
CSBUNIVSB62EG	402503	Universal Structural Attachment, Universal Sway Brace (1" - 4" sizes)

SHEAR NUT



Material: Steel
Finish: Electrogalvanized

Part Number	Article Number	Product
CSBIBSN37EG	402500	Adjustable I-Beam Attachment
CSBQIKCLSN37EG	402505	Quick Grip Jr. Lateral Sway Brace

Seismic Bracing Systems

RIGID BRACING

STANDARD UNIVERSAL SWAY BRACE

- Use for both lateral and longitudinal sway brace applications
- Snap-off bolt head helps enable easy installation and inspection of seismic sway braces
- Works with 1" through 2" brace pipes and 1/4" angle iron braces to reduce inventory
- Slotted design grabs service pipe for added gripping strength
- Meets NFPA®-13 requirements for seismic sway bracing

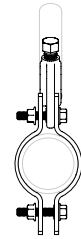
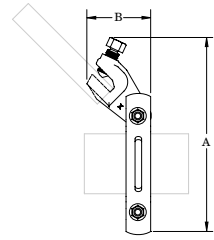
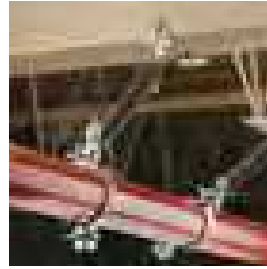

Material: Steel
Finish: Electrogalvanized



Part Number	Article Number	Pipe Size	NB/DN	A	B
CSBSTU0100EG	404385	1"	25	174.6 mm	25.0 mm
CSBSTU0125EG	404386	1 1/4"	32	187.4 mm	25.4 mm
CSBSTU0150EG	404387	1 1/2"	40	196.9 mm	25.4 mm
CSBSTU0200EG	404388	2"	50	206.4 mm	30.2 mm
CSBSTU0250EG	404389	2 1/2"	65	225.4 mm	30.2 mm
CSBSTU0300EG	404390	3"	80	238.1 mm	30.2 mm
CSBSTU0400EG	404391	4"	100	269.9 mm	38.1 mm
CSBSTU0500EG	404392	5"	125	308.0 mm	38.1 mm
CSBSTU0600EG	404393	6"	150	346.1 mm	50.8 mm
CSBSTU0800EG	404394	8"	200	400.1 mm	50.8 mm
CSBSTU1000EG	404395	10"	250	457.2 mm	50.8 mm

Seismic Bracing Systems

RIGID BRACING

UL Loads (Listed for Restraints)			
Part Number	Dyna-Flow® Service Pipe	Sch 10 Service Pipe	Sch 40 Service Pipe
CSBSTU0100xx	N/A	2910 N	2910 N
CSBSTU0125xx	2910 N	2910 N	2910 N
CSBSTU0150xx	2910 N	2910 N	2910 N

UL Loads (Listed for Sway Braces)								
Part Number	Lateral				Longitudinal			
	Dyna-Flow® Service Pipe	EZ FLOW™ Service Pipe	Sch 10 Service Pipe	Sch 40 Service Pipe	Dyna-Flow® Service Pipe	EZ FLOW™ Service Pipe	Sch 10 Service Pipe	Sch 40 Service Pipe
CSBSTU0200xx	13340 N	N/A	13340 N	13340 N	N/A	N/A	N/A	N/A
CSBSTU0250xx	13340 N	N/A	13340 N	13340 N	8960 N	N/A	8960 N	8960 N
CSBSTU0300xx	13340 N	N/A	13340 N	13340 N	8960 N	N/A	8960 N	8960 N
CSBSTU0400xx	13340 N	13340 N	13340 N	13340 N	8960 N	N/A	8960 N	8960 N
CSBSTU0500xx	N/A	13340 N	13340 N	13340 N	N/A	N/A	8960 N	8960 N
CSBSTU0600xx	N/A	13340 N	13340 N	13340 N	N/A	8960 N	8960 N	8960 N
CSBSTU0800xx	N/A	N/A	13340 N	13340 N	N/A	N/A	13340 N	13340 N
CSBSTU1000xx	N/A	N/A	13340 N	13340 N	N/A	N/A	13340 N	13340 N

FM Loads (Lightwall, Sch 10 and Sch 40 Service Pipes)								
Part Number	Horizontal Capacity per Installation Angle from Vertical							
	Lateral				Longitudinal			
	30° - 44°	45° - 59°	60° - 74°	75° - 90°	30° - 44°	45° - 59°	60° - 74°	75° - 90°
CSBSTU0100xx	3825 N	5425 N	6670 N	7430 N	4315 N	3200 N	3825 N	4270 N
CSBSTU0125xx	3825 N	5425 N	6670 N	7430 N	4315 N	3200 N	3825 N	4270 N
CSBSTU0150xx	3825 N	5425 N	6670 N	7430 N	4315 N	3200 N	3825 N	4270 N
CSBSTU0200xx	6805 N	9610 N	11790 N	13165 N	3870 N	3070 N	3690 N	4136 N
CSBSTU0250xx	6805 N	9610 N	11790 N	13165 N	3870 N	3070 N	3690 N	4136 N
CSBSTU0300xx	6805 N	9610 N	11790 N	13165 N	3870 N	3070 N	3690 N	4136 N
CSBSTU0400xx	6985 N	9875 N	12100 N	13480 N	6895 N	6185 N	7475 N	8320 N
CSBSTU0500xx	6985 N	9875 N	12100 N	13480 N	6895 N	6185 N	7475 N	8320 N
CSBSTU0600xx	8805 N	12500 N	15300 N	17080 N	6540 N	5205 N	6270 N	6985 N

FM Loads (4.8 mm wall and Sch 40 Service Pipes)								
Part Number	Horizontal Capacity per Installation Angle from Vertical							
	Lateral				Longitudinal			
	30° - 44°	45° - 59°	60° - 74°	75° - 90°	30° - 44°	45° - 59°	60° - 74°	75° - 90°
CSBSTU0800xx	9075 N	12855 N	15745 N	17570 N	5340 N	7560 N	9295 N	10365 N
CSBSTU1000xx	9075 N	12855 N	15745 N	17570 N	5340 N	7560 N	9295 N	10365 N

Seismic Bracing Systems

RIGID BRACING

QUICK GRIP JR. LATERAL SWAY BRACE

- Easy two-step installation eliminates extra trips between structure and service pipe
- Works with 1" and 1 1/4" (25 mm and 32 mm) brace pipes to reduce inventory
- Snap-off bolt head helps enable easy installation and inspection of seismic sway braces
- Meets NFPA®-13 requirements for seismic sway bracing

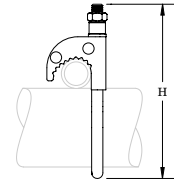
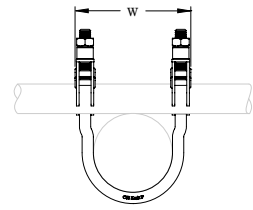
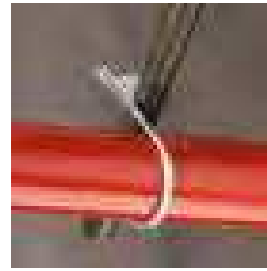

Material: Steel
Finish: Electrogalvanized



Part Number	Article Number	Pipe Size	NB/DN	Height	Width
CSBQIKCL0100EG	404373	1"	25	130.2 mm	65.3 mm
CSBQIKCL0125EG	404374	1 1/4"	32	136.5 mm	74.4 mm
CSBQIKCL0150EG	404375	1 1/2"	40	142.9 mm	80.2 mm
CSBQIKCL0200EG	404376	2"	50	161.9 mm	92.3 mm

Seismic Bracing Systems

RIGID BRACING

UL Loads (Listed for Restraints)			
Part Number	Service Pipe Schedule	Lateral	
		25 mm Brace Pipe	32 mm Brace Pipe
CSBQIKCL0100EG	Dyna-Flow®	N/A	N/A
	10	2910 N	2910 N
	40	2910 N	2910 N
CSBQIKCL0125EG	Dyna-Flow®	2910 N	2400 N
	10	2910 N	2400 N
	40	2910 N	2400 N
CSBQIKCL0150EG	Dyna-Flow®	3330 N	2910 N
	10	3330 N	2910 N
	40	3330 N	2910 N
CSBQIKCL0200EG	Dyna-Flow®	3330 N	2400 N
	10	3330 N	2400 N
	40	3330 N	2400 N

FM Loads					
Brace Direction to Structure	Service Pipe Size	Lateral			
		Horizontal Capacity per Installation Angle from Vertical			
		30° - 44°	45° - 59°	60° - 74°	75° - 90°
CSBQIKCL0100EG	EN10255 L (Lightwall)	1290 N	1830 N	2200 N	2445 N
	EN10255 M (10)	665 N	935 N	1245 N	1400 N
	EN10255 H (40)	2115 N	2960 N	3670 N	4115 N
CSBQIKCL0125EG	EN10255 L (Lightwall)	1290 N	1830 N	2200 N	2445 N
	EN10255 M (10)	665 N	935 N	1245 N	1400 N
	EN10255 H (40)	2115 N	2960 N	3670 N	4115 N
CSBQIKCL0150EG	EN10255 L (Lightwall)	1290 N	1830 N	2200 N	2445 N
	EN10255 M (10)	665 N	935 N	1245 N	1400 N
	EN10255 H (40)	2115 N	2960 N	3670 N	4115 N
CSBQIKCL0200EG	EN10255 L (Lightwall)	1735 N	2445 N	2980 N	3335 N
	EN10255 M (10)	1555 N	2225 N	2760 N	3070 N
	EN10255 H (40)	2180 N	3070 N	3780 N	4225 N

Seismic Bracing Systems

RIGID BRACING

QUICK GRIP LATERAL SWAY BRACE

- Easy two-step installation eliminates extra trips between structure and service pipe
- Works with 1" and 1 1/4" (25 mm and 32 mm) brace pipes to reduce inventory
- Yellow tips provide a visual indicator that the bolts have been properly torqued
- Easy installation with an impact wrench from the bottom side of the clamp
- Meets NFPA®-13 requirements for seismic sway bracing

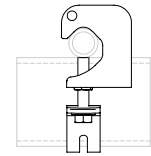
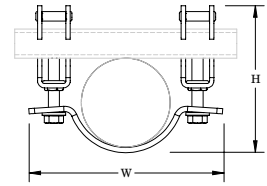
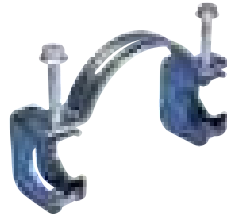

Material: Steel
Finish: Electrogalvanized



Part Number	Article Number	Pipe Size	NB/DN	Height	Width	Certifications
CSBQG0250MEG	404475	2 1/2"	65	138.1 – 148.6 mm	172.0 mm	FM Approved, Seismic
CSBQG0300EG	404469	3"	80	155.0 – 165.5 mm	190.0 mm	cULus, FM Approved, Seismic, OSHPD
CSBQG0400EG	404470	4"	100	180.4 – 190.9 mm	222.0 mm	cULus, FM Approved, Seismic, OSHPD
CSBQG0600EG	404472	6"	150	235.5 – 244.9 mm	298.0 mm	cULus, FM Approved, Seismic, OSHPD
CSBQG0800EG	404473	8"	200	289.2 – 300.0 mm	351.8 mm	cULus, FM Approved, Seismic, OSHPD

Load capacity according UL			
Part Number	Designation Brace Pipe	Lateral	
		25 mm Brace Pipe	32 mm Brace Pipe
CSBQG0250EG CSBQG0250MEG	Dyna-Flow®, Mega-Flow, Eddy Flow, Fire-Flo	8960 N	8960 N
	10	8960 N	8960 N
	40	8960 N	8960 N
CSBQG0300EG	Dyna-Flow®, Mega-Flow, Eddy Flow, Fire-Flo	8960 N	8960 N
	10	8960 N	8960 N
	40	8960 N	8960 N
CSBQG0400EG	Dyna-Flow®, Mega-Flow, Eddy Flow, Fire-Flo	8960 N	8960 N
	10	8960 N	8960 N
	40	8960 N	8960 N
CSBQG0600EG	Mega-Flow, Eddy Flow, Fire-Flo	8960 N	8960 N
	10	8960 N	8960 N
	40	8960 N	8960 N
CSBQG0800EG	10	8960 N	8960 N
	40	8960 N	8960 N

Seismic Bracing Systems

RIGID BRACING

FM Loads					
Part Number	Service Pipe Size	Lateral			
		Horizontal Capacity per Installation Angle from Vertical			
		30° - 44°	45° - 59°	60° - 74°	75° - 90°
CSBQG0250EG/ CSBQG0250MEG	EN10255 L (Lightwall)	6270 N	8895 N	10900 N	12190 N
	EN10255 M (10)	6270 N	8895 N	10900 N	12190 N
	EN10255 H (40)	6270 N	8895 N	10900 N	12190 N
CSBQG0300EG	EN10255 L (Lightwall)	5295 N	7475 N	9163 N	10230 N
	EN10255 M (10)	5295 N	7475 N	9163 N	10230 N
	EN10255 H (40)	5295 N	7475 N	9163 N	10230 N
CSBQG0400EG	EN10255 L (Lightwall)	5295 N	7475 N	9163 N	10230 N
	EN10255 M (10)	5295 N	7475 N	9163 N	10230 N
	EN10255 H (40)	5295 N	7475 N	9163 N	10230 N
CSBQG0600EG	EN10255 L (Lightwall)	3870 N	5470 N	6715 N	7515 N
	EN10255 M (10)	3870 N	5470 N	6715 N	7515 N
	EN10255 H (40)	4315 N	6095 N	7475 N	8320 N
CSBQG0800EG	4.8 mm (Wall Thickness)	3515 N	4940 N	6050 N	6760 N
	EN10255 H (40)	3515 N	4940 N	6050 N	6760 N

LATERAL TELESCOPING BRACE ASSEMBLY

- Complete, out of the box assembly is compatible with both steel (IPS) and CPVC piping
- Telescoping brace member eliminates the need to cut pipe, minimizing waste and allowing one person to effectively complete the installation
- Easy "push-to-install" nVent CADDY Rod Lock feature allows the V-bolt to assemble quickly, and helps eliminate the risk of compressing CPVC pipe
- Length of telescoping lateral brace is fixed by installing the included self-drilling screw
- Electrogalvanized coating throughout the entire assembly provides superior corrosion resistance, and eliminates the risk of exposing CPVC pipe to any harmful oils or residue
- Designed to reduce the installation time of a complete brace by up to 80%
- Design allows center loading of brace on the service pipe
- Meets requirements of NFPA® 13
- FM® Specification Tested

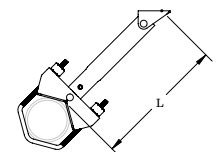
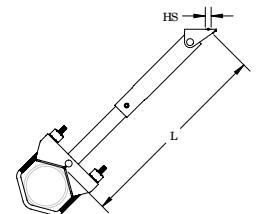

Material: Steel
Finish: Electrogalvanized



Part Number	Article Number	Brace Length	Pipe Size	NB/DN	Hole Size	Wrench Size	UL Listed Load
CSBT1	404300	0.30 – 0.46 m	1" – 4"	25 – 100	12.7 mm	5/16"	5,780 N
CSBT2	404301	0.46 – 0.91 m	1" – 4"	25 – 100	12.7 mm	5/16"	5,780 N

Seismic Bracing Systems

CABLE BRACING

WIRE SPOOL

- Cut to length as needed
- Pre-stretched restraint cable



Material: Steel
Finish: Pregalvanized, Painted



Part Number	Article Number	Brace Size	Diameter	Cable Length	UL Listed Load	Color
CSB12CBL	402190	#12	2.4 mm	76.2 m	2,668 N	Red
CSB18CBL	402191	#18	3.2 mm	76.2 m	4,893 N	White
CSB36CBL	402192	#36	4.8 mm	76.2 m	12,455 N	Blue

Cable is powder coated.

WIRE SPOOL, STAINLESS STEEL

- Cut to length as needed
- Pre-stretched restraint cable



Material: Stainless Steel 316 (EN 1.4401)
Static Load Safety Factor: 1.5:1

Part Number	Article Number	Brace Size	Diameter	Cable Length	Static Load
CSB12CBLSS	402510	#12	2.4 mm	76.2 m	2,400 N
CSB18CBLSS	402511	#18	3.2 mm	76.2 m	4,600 N
CSB36CBLSS	402512	#36	4.8 mm	76.2 m	9,700 N

OVAL SLEEVE

- Creates secure loop ends
- Swage with swaging tools



Material: Copper
Finish: Electroplated

Material: Stainless Steel 316 (EN 1.4401)

Part Number	Article Number	Brace Size	Part Number	Article Number	Brace Size
CSB12SLVB	402194	#12	CSB12SLVBSS	402514	#12
CSB18SLVB	402195	#18	CSB18SLVBSS	402515	#18
CSB36SLVB	402196	#36	CSB36SLVBSS	402516	#36

Two side-by-side swages required on #12 and #18 cable. Three side-by-side swages required on #36 and #48 cable. Check swage with gauge (not included).

Seismic Bracing Systems

CABLE BRACING

UNIVERSAL RESTRAINT CLIP

- Attaches cable brace to structure

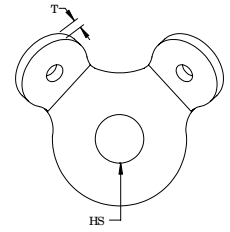
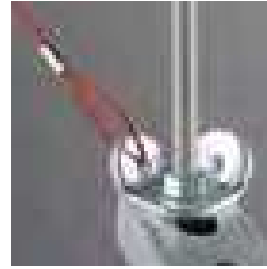

Part Number	Article Number	Brace Size	Hole Size	Thickness	UL Listed Load	Certifications
Material: Steel Finish: Electrogalvanized						
CSBURC38	402198	#12, #18, #36	11 mm	4.27 mm	7,117 N	UL
CSBURC12	402199	#12, #18, #36	14 mm	4.27 mm	7,117 N	UL
CSBURC58	402200	#12, #18, #36	17 mm	4.27 mm	7,117 N	UL
Material: Stainless Steel 316 (EN 1.4401)						
CSBURC38SS	402522	#12, #18, #36	11 mm	4.27 mm	-	-
CSBURC12SS	402523	#12, #18, #36	14 mm	4.27 mm	-	-
CSBURC58SS	402564	#12, #18, #36	17 mm	4.27 mm	-	-

Mount to the structure using the center hole. Loop cable through the holes in the bent tabs and swage in place.

UNIVERSAL RESTRAINT CLIP, SLOTTED

- Slotted design ideal for attaching to existing threaded rod on trapezes

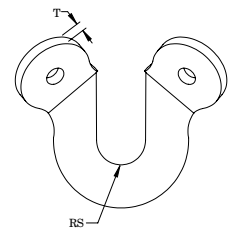

Material: Steel
Finish: Electrogalvanized

Part Number	Article Number	Brace Size	Rod Size	Thickness
CSBURCR38	402201	#12, #18	M10	4.27 mm
CSBURCR12	402202	#12, #18	M12	4.27 mm
CSBURCR58	402203	#12, #18	M16	4.27 mm

Seismic Bracing Systems

CABLE BRACING

NO PRY CLIP

- Eliminates prying effect on fasteners and anchors

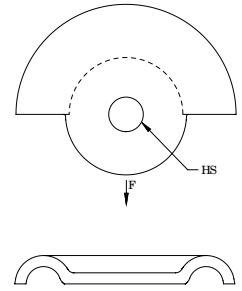

Material: Steel
Finish: Electrogalvanized

Part Number	Article Number	Brace Size	Hole Size	UL Listed Load
CSBNPC38	402528	#12, #18, #36	11 mm	12,460 N
CSBNPC12	402208	#12, #18, #36	14 mm	12,460 N
CSBNPC58	402529	#12, #18, #36	17 mm	12,460 N

WIRE ROPE CUTTER

- Designed to reduce cable fraying



Material: Steel

Part Number	Article Number	Brace Size
CSBC48	402536	#36, #48

For brace sizes #12 and #18 use SLWC Wire Rope Cutter.

WIRE ROPE CUTTER

- Designed to reduce wire rope fraying



Material: Steel

Part Number	Article Number
SLWC	195853

Seismic Bracing Systems

CABLE BRACING

MANUAL SWAGING TOOL



Material: Steel

Part Number	Article Number	Brace Size
CSB12SBHS	404461	#12

MULTI-SIZE MANUAL SWAGING TOOL



Material: Steel

Part Number	Article Number	Brace Size
CSB3346SB	402209	#12, #18, #36

BATTERY-OPERATED SWAGING TOOL

- Battery-operated tool provides consistent swaging
- Provides less strenuous installation when compared to manual swaging tools
- Cordless design allows installers to easily move around the job site
- Compatible with large diameter cables



Material: Steel



Part Number	Brace Size
CSBBS121836	#12, #18, #36

Seismic Bracing Systems

BRANCH LINE RESTRAINT SYSTEM

BRANCH LINE RESTRAINT PIPE ATTACHMENT

- Accepts 3/8" or 1/2" (M10 or M12) threaded rod
- Quick grip clamp simplifies measuring and cutting of threaded rod
- Eliminates need to cut threaded rod to exact dimensions
- Works with rough-cut threaded rod and eliminates pipe-side deburring
- Can be installed with threaded rod above or below the service pipe
- Shear-off head helps ensure correct torque and simplifies inspection

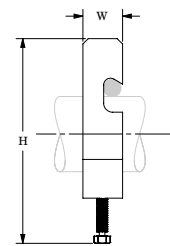
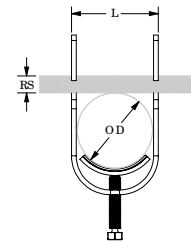

Material: Steel
Finish: Electrogalvanized



Part Number	Article Number	Pipe Size	NB/DN	Outer Diameter	Rod Size	Height	Length	Width
CSBBRP0100EG	404477	1"	25	33.4 mm	M10, M12	169.4 mm	41.4 mm	22.2 mm
CSBBRP0125EG	404478	1 1/4"	32	42.2 mm	M10, M12	192.0 mm	50.0 mm	22.2 mm
CSBBRP0150EG	404479	1 1/2"	40	48.3 mm	M10, M12	208.4 mm	56.1 mm	22.2 mm
CSBBRP0200EG	404480	2"	50	60.3 mm	M10, M12	240.0 mm	68.3 mm	22.2 mm

BRANCH LINE RESTRAINT STRUCTURE ATTACHMENT TO STEEL

- Swivel barrel nut accepts 3/8" or 1/2" (M10 or M12) threaded rod
- Attaches to steel members with self-drilling/tapping screw

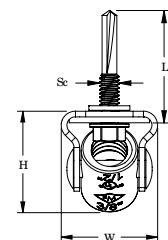
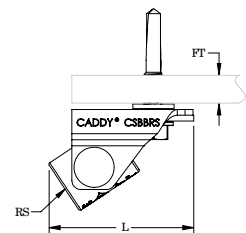

Material: Steel
Finish: Electrogalvanized



Part Number	Article Number	Rod Size	Flange Thickness	Height	Length	Width	Screw Diameter	Screw Length
CSBBS1MEG	402239	M10, M12	2.7 – 12.7 mm	28.2 mm	40.4 mm	26.9 mm	#12	32 mm

Branch line structural attachments are for restraint only and not for the hanging of fire sprinkler piping.

Seismic Bracing Systems

BRANCH LINE RESTRAINT SYSTEM

BRANCH LINE RESTRAINT STRUCTURE ATTACHMENT TO WOOD/CONCRETE

- Swivel barrel nut accepts 3/8" or 1/2" (M10 or M12) threaded rod
- Attaches to wood or concrete where cracked concrete approval is not needed

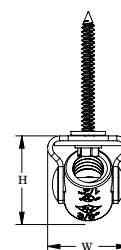
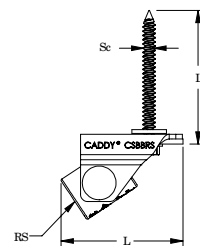
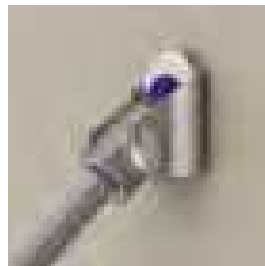

Material: Steel
Finish: Electrogalvanized

Part Number	Article Number	Rod Size	Height	Length	Width	Screw Diameter	Screw Length	Drill Bit Diameter
CSBBRS2MEG	402240	M10, M12	28.2 mm	40.4 mm	26.9 mm	1/4"	44.5 mm	5 mm

Branch line structural attachments are for restraint only and not for the hanging of fire sprinkler piping. Recommended drill bit is Powers Fasteners, Inc. part number 2785SD.

BRANCH LINE RESTRAINT STRUCTURE ATTACHMENT TO THREADED HOLE

- Swivel barrel nut accepts 3/8" or 1/2" (M10 or M12) threaded rod
- Attaches to concrete anchors or structural attachments with female threads
- Can be used for bolting through steel

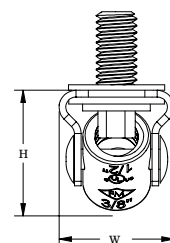
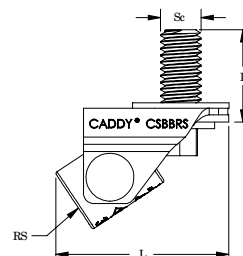

Material: Steel
Finish: Electrogalvanized

Part Number	Article Number	Rod Size	Height	Length	Width	Screw Diameter	Screw Length
CSBBRS3MEG	402241	M10, M12	28.2 mm	40.4 mm	26.9 mm	M10	19 mm

Branch line structural attachments are for restraint only and not for the hanging of fire sprinkler piping.

Seismic Bracing Systems

ROD STIFFENERS

PIPE ROD STIFFENER

- For use with Schedule 40 or Schedule 10 pipe
- Secures pipe to threaded rod for stiffening

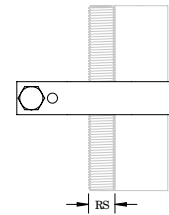
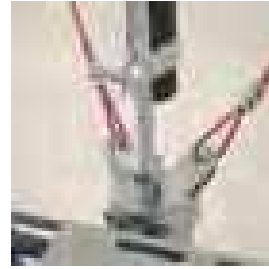

Material: Steel
Finish: Electrogalvanized

Part Number	Article Number	Brace Pipe Size	Brace NB/DN	Rod Size
CSBRS1	402207	1"	25 mm	M10, M12, M16

STRUT ROD STIFFENER

- Secures strut channel to threaded rod for stiffening

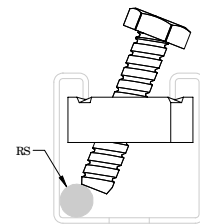

Material: Steel
Finish: Electrogalvanized

Part Number	Article Number	Strut Type	Rod Size
CSBRS37EG	404467	A (41 x 41 mm)	M10, M12, M16, M20

NVENT CADDY QUICK CLIP ROD STIFFENER

- Secures strut channel to threaded rod for stiffening
- One hand, snap-in place installation
- No tools or bolt tightening required

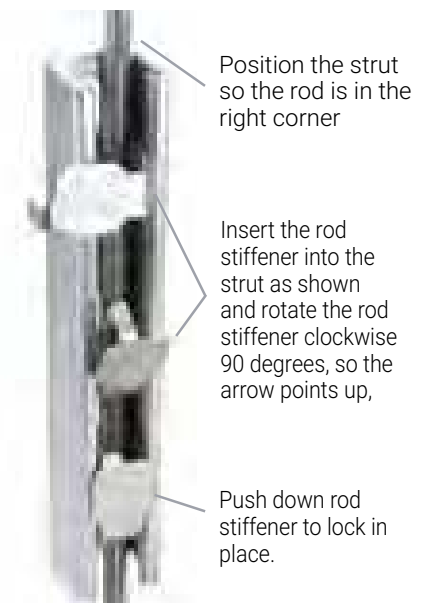
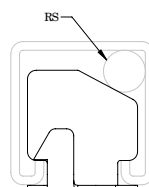
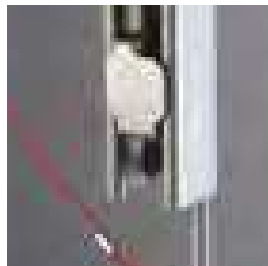

Material: Stainless Steel 316 (EN 1.4401)

Part Number	Article Number	Strut Type	Rod Size
CSBRS2	404538	A (41 x 41 mm)	M10
CSBRS3	404539	A (41 x 41 mm)	M12

11. Metal Framing



Metal Framing

NVENT CADDY ERISTRUT STRUT CHANNEL SYSTEM

STRUT CHANNEL TYPE A, SLOTTED

- Cold formed channel, slotted
- Strut channels for heavy applications
- For individual fastening or for efficiently constructing pipe or tube routes

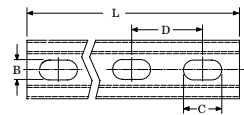
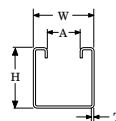
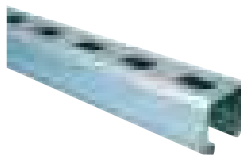

Part Number	Article Number	Length	Height	Width	Thickness	A	B	C	D	Certifications
Material: Stainless Steel 316 (EN 1.4401)										
A25H2000S6	310322	2,000 mm	41 mm	41 mm	2.5 mm	22.3 mm	14 mm	27 mm	50 mm	
A25H6000S6	310326	6,000 mm	41 mm	41 mm	2.5 mm	22.3 mm	14 mm	27 mm	50 mm	
Material: Steel – Finish: Hot-Dip Galvanized										
A15L3000HD	317241	3,000 mm	41 mm	41 mm	1.5 mm	22.3 mm	11 mm	27 mm	50 mm	ITB
A25H3000HD	310339	3,000 mm	41 mm	41 mm	2.5 mm	22.3 mm	14 mm	27 mm	50 mm	ITB
A15L6000HD	317251	6,000 mm	41 mm	41 mm	1.5 mm	22.3 mm	11 mm	27 mm	50 mm	ITB
A25H6000HD	310358	6,000 mm	41 mm	41 mm	2.5 mm	22.3 mm	14 mm	27 mm	50 mm	ITB
Material: Steel – Finish: Pregalvanized										
A15L2000PG	317096	2,000 mm	41 mm	41 mm	1.5 mm	22.3 mm	11 mm	27 mm	50 mm	ITB
A20L2000PG	310293	2,000 mm	41 mm	41 mm	2.0 mm	22.3 mm	11 mm	27 mm	50 mm	ITB
A25H2000PG	385505	2,000 mm	41 mm	41 mm	2.5 mm	22.3 mm	14 mm	27 mm	50 mm	ITB
A15L3000PG	317099	3,000 mm	41 mm	41 mm	1.5 mm	22.3 mm	11 mm	27 mm	50 mm	ITB
A20L3000PG	310303	3,000 mm	41 mm	41 mm	2.0 mm	22.3 mm	11 mm	27 mm	50 mm	ITB
A25H3000PG	310299	3,000 mm	41 mm	41 mm	2.5 mm	22.3 mm	14 mm	27 mm	50 mm	ITB
A25H4000PG	310333	4,000 mm	41 mm	41 mm	2.5 mm	22.3 mm	14 mm	27 mm	50 mm	
A15L6000PG	317111	6,000 mm	41 mm	41 mm	1.5 mm	22.3 mm	11 mm	27 mm	50 mm	ITB
A20L6000PG	310313	6,000 mm	41 mm	41 mm	2.0 mm	22.3 mm	11 mm	27 mm	50 mm	ITB
A25H6000PG	310311	6,000 mm	41 mm	41 mm	2.5 mm	22.3 mm	14 mm	27 mm	50 mm	ITB

Metal Framing

NVENT CADDY ERISTRUT STRUT CHANNEL SYSTEM

STRUT CHANNEL TYPE AA, SLOTTED

- Cold formed channel, slotted
- Welded back to back

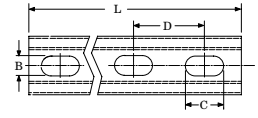
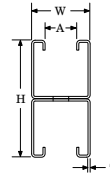
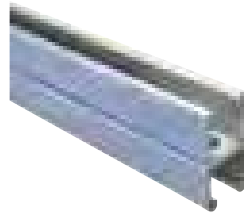

Material: Steel

Part Number	Article Number	Length	Height	Width	Thickness	A	B	C	D	Certifications
Finish: Hot-Dip Galvanized										
AA25H0400HD	330390	400 mm	82 mm	41 mm	2.5 mm	22.3 mm	14 mm	27 mm	50 mm	ITB
AA25H0600HD	330410	600 mm	82 mm	41 mm	2.5 mm	22.3 mm	14 mm	27 mm	50 mm	ITB
AA25H0800HD	330420	800 mm	82 mm	41 mm	2.5 mm	22.3 mm	14 mm	27 mm	50 mm	ITB
AA25H1000HD	330430	1,000 mm	82 mm	41 mm	2.5 mm	22.3 mm	14 mm	27 mm	50 mm	ITB
AA25H2000HD	330440	2,000 mm	82 mm	41 mm	2.5 mm	22.3 mm	14 mm	27 mm	50 mm	
AA25H3000HD	310221	3,000 mm	82 mm	41 mm	2.5 mm	22.3 mm	14 mm	27 mm	50 mm	ITB
AA25H6000HD	310231	6,000 mm	82 mm	41 mm	2.5 mm	22.3 mm	14 mm	27 mm	50 mm	ITB
Finish: Pregalvanized										
AA25H3000PG	310181	3,000 mm	82 mm	41 mm	2.5 mm	22.3 mm	14 mm	27 mm	50 mm	ITB
AA25H6000PG	310191	6,000 mm	82 mm	41 mm	2.5 mm	22.3 mm	14 mm	27 mm	50 mm	ITB

STRUT CHANNEL TYPE AS, PERFORATED

- Cold formed channel, slotted
- Contains side perforations

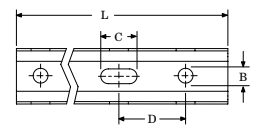
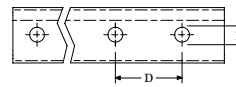
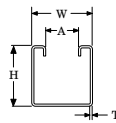

Material: Steel

Part Number	Article Number	Length	Height	Width	Thickness	A	B	C	D	Certifications
Finish: Hot-Dip Galvanized										
A25S3000HD	310400	3,000 mm	41 mm	41 mm	2.5 mm	22.3 mm	11 mm	27 mm	50 mm	ITB
A25S6000HD	310410	6,000 mm	41 mm	41 mm	2.5 mm	22.3 mm	11 mm	27 mm	50 mm	ITB
Finish: Pregalvanized										
A25S3000PG	310360	3,000 mm	41 mm	41 mm	2.5 mm	22.3 mm	11 mm	27 mm	50 mm	ITB
A25S6000PG	310370	6,000 mm	41 mm	41 mm	2.5 mm	22.3 mm	11 mm	27 mm	50 mm	ITB

Metal Framing

NVENT CADDY ERISTRUT STRUT CHANNEL SYSTEM

STRUT CHANNEL TYPE C, SLOTTED

- Cold formed channel, slotted
- Strut channels for medium to heavy applications
- For individual fastening or for efficiently constructing pipe or tube routes

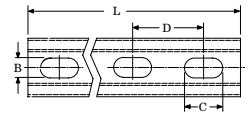
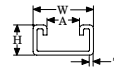
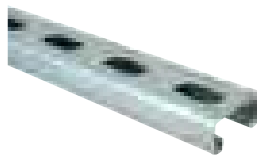

Part Number	Article Number	Length	Height	Width	Thickness	A	B	C	D	Certifications
Material: Stainless Steel 316 (EN 1.4401)										
C25H2000S6	317118	2,000 mm	21 mm	41 mm	2.5 mm	22.3 mm	11 mm	27 mm	50 mm	
C25H6000S6	310265	6,000 mm	21 mm	41 mm	2.5 mm	22.3 mm	14 mm	27 mm	50 mm	
Material: Steel – Finish: Hot-Dip Galvanized										
C25H3000HD	310281	3,000 mm	21 mm	41 mm	2.5 mm	22.3 mm	14 mm	27 mm	50 mm	ITB
C25H6000HD	310291	6,000 mm	21 mm	41 mm	2.5 mm	22.3 mm	14 mm	27 mm	50 mm	ITB
Material: Steel – Finish: Pregalvanized										
C15L2000PG	317116	2,000 mm	21 mm	41 mm	1.5 mm	22.3 mm	11 mm	27 mm	50 mm	ITB
C20L2000PG	310256	2,000 mm	21 mm	41 mm	2.0 mm	22.3 mm	11 mm	27 mm	50 mm	ITB
C25H2000PG	387365	2,000 mm	21 mm	41 mm	2.5 mm	22.3 mm	14 mm	27 mm	50 mm	ITB
C15L3000PG	317119	3,000 mm	21 mm	41 mm	1.5 mm	22.3 mm	11 mm	27 mm	50 mm	ITB
C20L3000PG	310257	3,000 mm	21 mm	41 mm	2.0 mm	22.3 mm	11 mm	27 mm	50 mm	ITB
C25H3000PG	310241	3,000 mm	21 mm	41 mm	2.5 mm	22.3 mm	14 mm	27 mm	50 mm	ITB
C25H4000PG	310283	4,000 mm	21 mm	41 mm	2.5 mm	22.3 mm	14 mm	27 mm	50 mm	
C15L6000PG	317131	6,000 mm	21 mm	41 mm	1.5 mm	22.3 mm	11 mm	27 mm	50 mm	ITB
C25H6000PG	310255	6,000 mm	21 mm	41 mm	2.5 mm	22.3 mm	14 mm	27 mm	50 mm	ITB

Metal Framing

NVENT CADDY ERISTRUT STRUT CHANNEL SYSTEM

STRUT CHANNEL TYPE CC, SLOTTED

- Cold formed channel, slotted
- Welded back to back

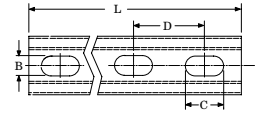
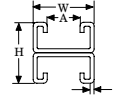

Material: Steel

Part Number	Article Number	Length	Height	Width	Thickness	A	B	C	D	Certifications
Finish: Hot-Dip Galvanized										
CC25H0400HD	330210	400 mm	41 mm	41 mm	2.5 mm	22.3 mm	14 mm	27 mm	50 mm	ITB
CC25H0500HD	330220	500 mm	41 mm	41 mm	2.5 mm	22.3 mm	14 mm	27 mm	50 mm	
CC25H0600HD	330230	600 mm	41 mm	41 mm	2.5 mm	22.3 mm	14 mm	27 mm	50 mm	ITB
CC25H6000HD	310111	6,000 mm	41 mm	41 mm	2.5 mm	22.3 mm	14 mm	27 mm	50 mm	ITB
Finish: Pregalvanized										
CC25H3000PG	310061	3,000 mm	41 mm	41 mm	2.5 mm	22.3 mm	14 mm	27 mm	50 mm	ITB
CC25H6000PG	310071	6,000 mm	41 mm	41 mm	2.5 mm	22.3 mm	14 mm	27 mm	50 mm	ITB

STRUT CHANNEL TYPE D, SLOTTED

- Cold formed channel, slotted

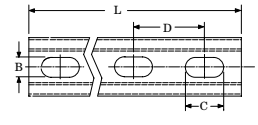
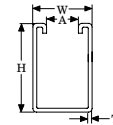

Material: Steel
Finish: Pregalvanized

Part Number	Article Number	Length	Height	Width	Thickness	A	B	C	D	Certifications
D25H3000PG	310630	3,000 mm	62 mm	41 mm	2.5 mm	22.3 mm	14 mm	27 mm	50 mm	ITB
D25H6000PG	310635	6,000 mm	62 mm	41 mm	2.5 mm	22.3 mm	14 mm	27 mm	50 mm	ITB

Metal Framing

NVENT CADDY ERISTRUT STRUT CHANNEL SYSTEM

STRUT CHANNEL TYPE DD, SLOTTED

- Cold formed channel, slotted
- Welded back to back

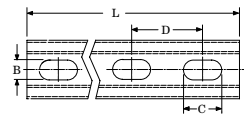
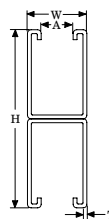

Material: Steel
Finish: Pregalvanized

Part Number	Article Number	Length	Height	Width	Thickness	A	B	C	D	Certifications
DD25H6000PG	310650	6,000 mm	124 mm	41 mm	2.5 mm	22.3 mm	14 mm	27 mm	50 mm	ITB

STRUT CHANNEL TYPE E, SLOTTED

- Cold formed channel, slotted

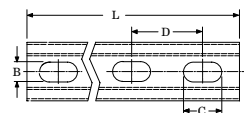
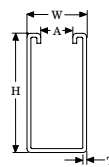

Material: Steel
Finish: Pregalvanized

Part Number	Article Number	Length	Height	Width	Thickness	A	B	C	D	Certifications
E12H1000PG	310600	3,000 mm	83 mm	41 mm	2.5 mm	22.3 mm	14 mm	27 mm	50 mm	ITB
E25H6000PG	310605	6,000 mm	83 mm	41 mm	2.5 mm	22.3 mm	14 mm	27 mm	50 mm	ITB

STRUT CHANNEL TYPE EE, SLOTTED

- Cold formed channel, slotted
- Welded back to back

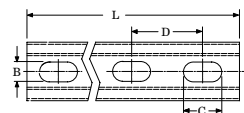
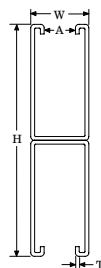

Material: Steel
Finish: Pregalvanized

Part Number	Article Number	Length	Height	Width	Thickness	A	B	C	D
EE25H6000PG	310620	6,000 mm	165 mm	41 mm	2.5 mm	22.3 mm	14 mm	27 mm	50 mm

Metal Framing

NVENT CADDY ERISTRUT STRUT CHANNEL SYSTEM

STRUT TO STRUT CONNECTOR

- Consists of two halve castings, nut and bolt
- Allows for bolting two strut channels back to back through the slots

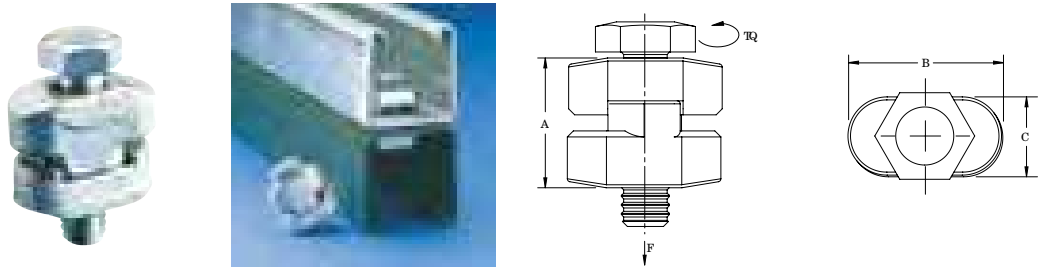

Material: Steel
Finish: Electrogalvanized

Part Number	Article Number	A	B	C	Torque	Static Load
STS	315450	32 mm	25 mm	12.7 mm	7 N-m	4,900 N

Minimum of 2 required. Maximum spacing 1 foot (300mm).

ADK STRUT END CAP

- Fits into ERISTRUT Type A channel
- When separated, provides two end caps for ERISTRUT Type C channel

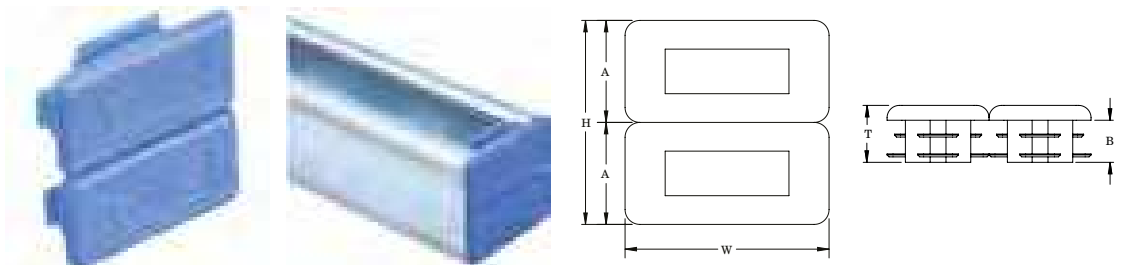

Material: Polyethylene

Part Number	Article Number	Color	Strut Type	Height	Width	A	B	Thickness
ADK421	313305	Blue	A (41 x 41 mm), C (21 x 41 mm)	41.2 mm	41.2 mm	20.6 mm	8.5 mm	11.5 mm

STRUT CHANNEL COVER

- Easily snaps into any ERISTRUT strut channel



Material: Polyvinylchloride

Part Number	Article Number	Length
CL3000PS	313310	3,000 mm

Metal Framing

NVENT CADDY ERISTRUT STRUT CHANNEL SYSTEM

QUICK STRUT NUT

- Provides fast universal attachment of threaded rod and hardware to standard strut profiles
- Pre-assembled slide nut ready to use out of the box
- Spring retains assembly in place until hardware is tightened

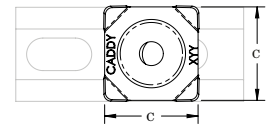
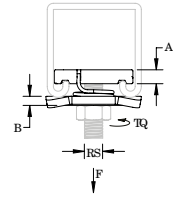

Material: Steel
Finish: Electrogalvanized

Part Number	Article Number	Rod Size	A	B	C	Torque	Static Load 1	Static Load 2	Static Load 3
QSNM6EG	592900	M6	6 mm	4 mm	41 mm	12 N-m	2,000 N	2,000 N	2,000 N
QSNM8EG	592910	M8	6 mm	4 mm	41 mm	28 N-m	3,300 N	3,300 N	3,300 N
QSNM10EG	592920	M10	8 mm	4 mm	41 mm	55 N-m	4,400 N	4,400 N	4,900 N
QSNM12EG	592930	M12	8 mm	4 mm	41 mm	65 N-m	4,400 N	4,700 N	4,900 N

Static Load 1 represents 1.5 mm strut channel thickness. Static Load 2 represents 2.0 mm strut channel thickness. Static Load 3 represents 2.5 mm strut channel thickness. Static Load 3 is 3,700 N for M10 and M12 thread sizes when using strut channel types D or E.

QUICK STRUT NUT WITH STUD

- Provides fast universal attachment of threaded rod and hardware to standard strut profiles
- Pre-assembled slide nut ready to use out of the box
- Spring retains assembly in place until hardware is tightened

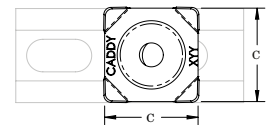
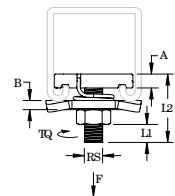

Material: Steel
Finish: Electrogalvanized

Part Number	Article Number	Rod Size	Length 1	Length 2	A	B	C	Torque	Static Load 1	Static Load 2	Static Load 3
QSNM8040EG	592912	M8	26 mm	50 mm	6 mm	4 mm	41 mm	28 N-m	3,300 N	3,300 N	3,300 N
QSNM8060EG	592914	M8	46 mm	70 mm	6 mm	4 mm	41 mm	28 N-m	3,300 N	3,300 N	3,300 N
QSNM10040EG	592922	M10	22 mm	50 mm	8 mm	4 mm	41 mm	55 N-m	4,400 N	4,400 N	4,900 N
QSNM10060EG	592924	M10	42 mm	70 mm	8 mm	4 mm	41 mm	55 N-m	4,400 N	4,400 N	4,900 N

Static Load 1 represents 1.5 mm strut channel thickness. Static Load 2 represents 2.0 mm strut channel thickness. Static Load 3 represents 2.5 mm strut channel thickness.

Static Load 3 is 3,670 N for M10 and M12 thread sizes when using strut channel types D or E.

Metal Framing

NVENT CADDY ERISTRUT STRUT CHANNEL SYSTEM

STRUT NUT WITHOUT SPRING

- Used to create metal frames with nVent CADDY Eristrut channels

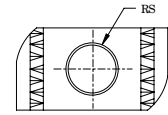
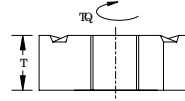

Static Load Safety Factor: 3:1

Part Number	Article Number	Rod Size	Thickness	Torque
Material: Stainless Steel 316 (EN 1.4401)				
NUTM6S6	315140	M6	6.0 mm	12 N-m
NUTM8S6	315150	M8	6.0 mm	28 N-m
NUTM10S6	315160	M10	8.0 mm	55 N-m
NUTM12S6	315170	M12	8.0 mm	55 N-m
Material: Steel — Finish: Electrogalvanized				
NUTM6EG	314995	M6	6.0 mm	12 N-m
NUTM8EG	315015	M8	6.0 mm	28 N-m
NUTM10EG	315025	M10	8.0 mm	55 N-m
NUTM12EG	315035	M12	8.0 mm	55 N-m
NUTM16EG	315036	M16	11.7 mm	125 N-m
Material: Steel — Finish: Hot-Dip Galvanized				
NUTM6HD	315000	M6	6.0 mm	12 N-m
NUTM8HD	315010	M8	6.0 mm	28 N-m
NUTM10HD	315020	M10	8.0 mm	55 N-m
NUTM12HD	315030	M12	8.0 mm	55 N-m
NUTM12THD	315031	M12	11.7 mm	65 N-m
NUTM16HD	315037	M16	11.7 mm	125 N-m

Pull-Out Strength				
Part Number	Channel Type	Channel Thickness		
		2,5 mm	2 mm	1,5 mm
NUTM6xx	A, C	2000 N	2000 N	2000 N
	D, E	2000 N	-	-
NUTM8xx	A, C	3330 N	3330 N	3330 N
	D, E	3330 N	-	-
NUTM10xx	A, C	4890 N	4440 N	4440 N
	D, E	4890 N	-	-
NUTM12xx	A, C	4890 N	4660 N	4440 N
	D, E	3670 N	-	-
NUTM12Txx	A	5670 N	5050 N	4440 N
	D, E	4250 N	-	-
NUTM16xx	A	5670 N	4660 N	4440 N
	D, E	4250 N	-	-

Metal Framing

NVENT CADDY ERISTRUT STRUT CHANNEL SYSTEM

STRUT NUT WITH SPRING, CHANNEL TYPE A

- Used to create metal frames with nVent CADDY Eristrut channels
- Spring allows for easy installation

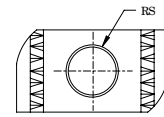
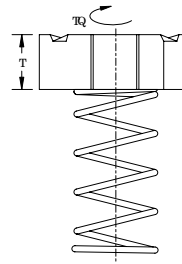

Static Load Safety Factor: 3:1

Part Number	Article Number	Rod Size	Thickness	Torque
Material: Stainless Steel 316 (EN 1.4401)				
SPRAM6S6	315180	M6	6.0 mm	12 N-m
SPRAM8S6	315190	M8	6.0 mm	28 N-m
SPRAM10S6	315120	M10	8.0 mm	55 N-m
Material: Steel – Finish: Electrogalvanized				
SPRAM6EG	315085	M6	6.0 mm	12 N-m
SPRAM8EG	315095	M8	6.0 mm	28 N-m
SPRAM10EG	315105	M10	8.0 mm	55 N-m
SPRAM12EG	315115	M12	8.0 mm	55 N-m
Material: Steel – Finish: Hot-Dip Galvanized				
SPRAM6HD	315080	M6	6.0 mm	12 N-m
SPRAM8HD	315090	M8	6.0 mm	28 N-m
SPRAM10HD	315100	M10	8.0 mm	55 N-m
SPRAM12HD	315110	M12	8.0 mm	55 N-m

Pull-Out Strength			
Part Number	Channel Thickness		
	2,5 mm	2 mm	1,5 mm
SPRAM6xx	2000 N	2000 N	2000 N
SPRAM8xx	3330 N	3330 N	3330 N
SPRAM10xx	4890 N	4440 N	4440 N
SPRAM12xx	4890 N	4660 N	4440 N
SPRAM12Txx	5670 N	5050 N	4440 N

Metal Framing

NVENT CADDY ERISTRUT STRUT CHANNEL SYSTEM

STRUT NUT WITH SPRING, CHANNEL TYPE C

- Used to create metal frames with nVent CADDY Eristrut channels
- Spring allows for easy installation

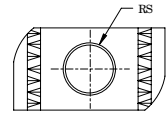
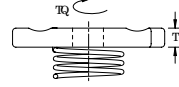

Static Load Safety Factor: 3:1

Part Number	Article Number	Rod Size	Thickness	Torque
Material: Stainless Steel 316 (EN 1.4401)				
SPRCM6S6	315210	M6	6 mm	12 N-m
SPRCM8S6	315220	M8	6 mm	28 N-m
SPRCM10S6	315230	M10	8 mm	55 N-m
Material: Steel – Finish: ElectroGalvanized				
SPRCM6EG	315045	M6	6 mm	12 N-m
SPRCM8EG	315055	M8	6 mm	28 N-m
SPRCM10EG	315065	M10	8 mm	55 N-m
SPRCM12EG	315075	M12	8 mm	55 N-m
Material: Steel – Finish: Hot-Dip Galvanized				
SPRCM6HD	315040	M6	6 mm	12 N-m
SPRCM8HD	315050	M8	6 mm	28 N-m
SPRCM10HD	315060	M10	8 mm	55 N-m
SPRCM12HD	315070	M12	8 mm	55 N-m

Pull-Out Strength			
Part Number	Channel Thickness		
	2,5 mm	2 mm	1,5 mm
SPRCM6xx	2000 N	2000 N	2000 N
SPRCM8xx	3330 N	3330 N	3330 N
SPRCM10xx	4890 N	4440 N	4440 N
SPRCM12xx	4890 N	4660 N	4440 N

Metal Framing

NVENT CADDY ERISTRUT STRUT CHANNEL SYSTEM

STRUT T-BOLT

- Pre-mounted with large washer and nut

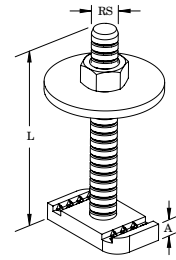

Part Number	Article Number	Rod Size	Length
Material: Stainless Steel 304 (EN 1.4301)			
TMN08040S4	590093	M8	40 mm
TMN10040S4	590094	M10	40 mm
TMN12040S4	590095	M12	40 mm
Material: Steel – Finish: Electrogalvanized			
TMN08030EG	590220	M8	30 mm
TMN08040EG	590080	M8	40 mm
TMN08050EG	590221	M8	50 mm
TMN08060EG	590222	M8	60 mm
TMN08100EG	590223	M8	100 mm
TMN10030EG	590218	M10	30 mm
TMN10040EG	590090	M10	40 mm
TMN10050EG	590224	M10	50 mm
TMN10060EG	590225	M10	60 mm
TMN10080EG	590227	M10	80 mm
TMN12040EG	590100	M12	40 mm

Metal Framing

NVENT CADDY ERISTRUT STRUT CHANNEL SYSTEM

CLIP-ON STRUT NUT

- Easily snaps into strut using a screwdriver

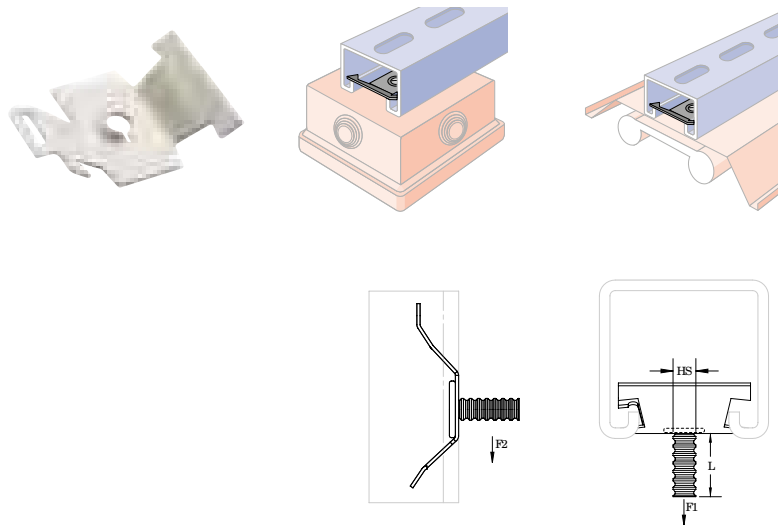

Material: Spring Steel
Finish: nVent CADDY Armour

Part Number	Article Number	Hole Size	Hole Type	Screw Included	Static Load 1	Ultimate Static Load 2
MFAM6	160310	M6	Threaded	No	450 N	200 N

Metal Framing

NVENT CADDY ERISTRUT STRUT CHANNEL SYSTEM

STRUT CANTILEVER ARM TYPE A, SLOTTED

- Slotted channel
- Welded on flat mounting plate

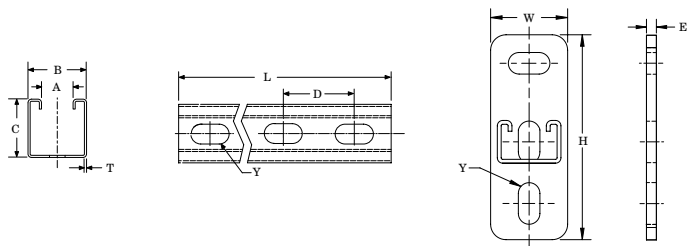

Part Number	Article Number	Length	Height	Width	Certifications	
Material: Stainless Steel 316 (EN 1.4401)						
KA25H0150S6	311693	150 mm	133 mm	50 mm		
KA25H0300S6	311694	300 mm	133 mm	50 mm		
KA25H0450S6	311695	450 mm	133 mm	50 mm		
KA25H0600S6	311696	600 mm	133 mm	50 mm		
Material: Steel – Finish: Electrogalvanized						
KA25H0150EG	311707	150 mm	133 mm	50 mm	ITB	
KA25H0200EG	311708	200 mm	133 mm	50 mm	ITB	
KA25H0300EG	311717	300 mm	133 mm	50 mm	ITB	
KA25H0450EG	311728	450 mm	133 mm	50 mm	ITB	
KA25H0500EG	311729	500 mm	133 mm	50 mm	ITB	
KA25H0600EG	311731	600 mm	133 mm	50 mm	ITB	
KA25H0750EG	311756	750 mm	133 mm	50 mm	ITB	
Material: Steel – Finish: Hot-Dip Galvanized						
KA25H0150HD	311702	150 mm	133 mm	50 mm	ITB	
KA25H0200HD	311703	200 mm	133 mm	50 mm	ITB	
KA25H0300HD	311713	300 mm	133 mm	50 mm	ITB	
KA25H0450HD	311718	450 mm	133 mm	50 mm	ITB	
KA25H0500HD	311732	500 mm	133 mm	50 mm	ITB	
KA25H0600HD	311733	600 mm	133 mm	50 mm	ITB	
KA25H0750HD	311757	750 mm	133 mm	50 mm	ITB	
KA25H1000HD	311758	1,000 mm	133 mm	50 mm	ITB	
KA25H1200HD	311759	1,200 mm	133 mm	50 mm	ITB	
KA25H1500HD	311760	1,500 mm	133 mm	50 mm	ITB	
KA25H2000HD	311761	2,000 mm	133 mm	50 mm	ITB	
A	B	C	D	E	Y	Thickness
22 mm	41 mm	41 mm	50 mm	8 mm	14 x 27 mm	2.5 mm

Metal Framing

NVENT CADDY ERISTRUT STRUT CHANNEL SYSTEM

STRUT CANTILEVER ARM TYPE AA, SLOTTED

- Channel welded back to back
- Welded on flat mounting plate

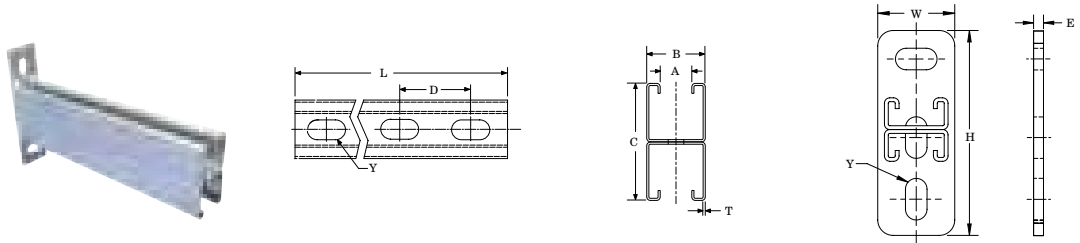

Material: Steel
Finish: Hot-Dip Galvanized

Part Number	Article Number	Length	Height	Width	Certifications
KAA25H0300HD	311401	300 mm	165 mm	50 mm	ITB
KAA25H0500HD	311419	500 mm	165 mm	50 mm	ITB
KAA25H0750HD	311431	750 mm	165 mm	50 mm	ITB
KAA25H1050HD	311451	1,050 mm	165 mm	50 mm	ITB

A	B	C	D	E	Y	Thickness
22 mm	41 mm	82 mm	50 mm	8 mm	14 x 27 mm	2.5 mm

STRUT CANTILEVER ARM TYPE C, SLOTTED

- Slotted channel
- Welded on flat mounting plate

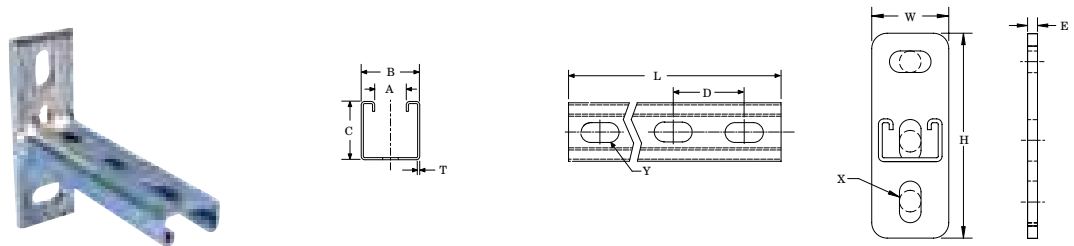

Material: Steel

Part Number	Article Number	Length	Thickness	Height	Width	X	Y	Certifications
Finish: Electrogalvanized								
KC25H0150EG	311657	150 mm	2.5 mm	133 mm	50 mm	14 x 27 mm	14 x 27 mm	ITB
KC25H0300EG	311667	300 mm	2.5 mm	133 mm	50 mm	14 x 27 mm	14 x 27 mm	ITB
KC25H0450EG	311677	450 mm	2.5 mm	133 mm	50 mm	14 x 27 mm	14 x 27 mm	ITB
Finish: Hot-Dip Galvanized								
KC25H0150HD	311649	150 mm	2.5 mm	133 mm	50 mm	14 x 27 mm	14 x 27 mm	ITB
KC25H0300HD	311659	300 mm	2.5 mm	133 mm	50 mm	14 x 27 mm	14 x 27 mm	ITB
KC25H0450HD	311669	450 mm	2.5 mm	133 mm	50 mm	14 x 27 mm	14 x 27 mm	ITB

A	B	C	D	E
22 mm	41 mm	21 mm	50 mm	8 mm

Metal Framing

NVENT CADDY ERISTRUT STRUT CHANNEL SYSTEM

STRUT CANTILEVER ARM TYPE CC, SLOTTED

- Welded back to back on flat mounting plate

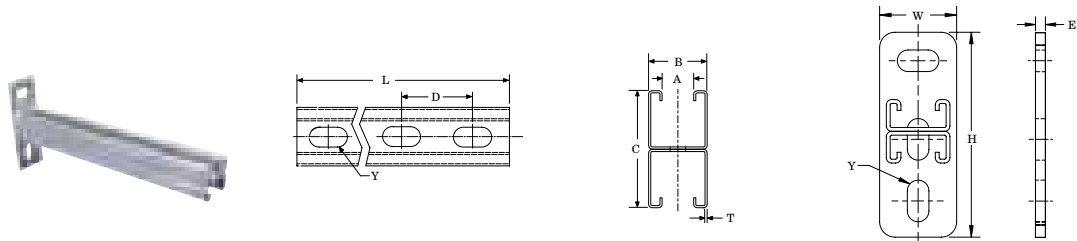

Material: Steel
Finish: Hot-Dip Galvanized

Part Number	Article Number	Length	Height	Width	Certifications
KCC25H0300HD	311805	300 mm	133 mm	50 mm	ITB
KCC25H0450HD	311815	450 mm	133 mm	50 mm	ITB
KCC25H0600HD	311825	600 mm	133 mm	50 mm	ITB

A	B	C	D	E	Y	Thickness
22 mm	41 mm	41 mm	50 mm	8 mm	14 x 27 mm	2.5 mm

CTRI CANTILEVER ARM FOR CABLE TRAY

- Cable tray type
- Welded on flat mounting plate

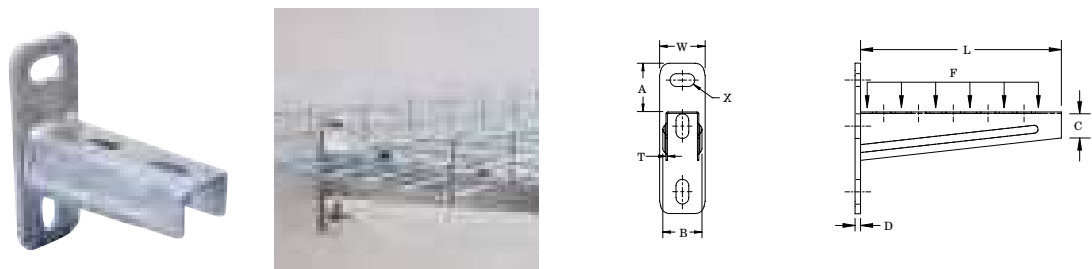

Material: Steel
Finish: Hot-Dip Galvanized

Part Number	Article Number	Length	Width	Static Load	Certifications
CTRI120HD	311920	120 mm	50 mm	1,500 N	ITB
CTRI160HD	311925	170 mm	50 mm	1,250 N	ITB
CTRI210HD	311930	220 mm	50 mm	1,125 N	ITB
CTRI260HD	311935	270 mm	50 mm	875 N	ITB
CTRI310HD	311940	320 mm	50 mm	750 N	ITB
CTRI410HD	311945	420 mm	50 mm	750 N	ITB
CTRI510HD	311950	520 mm	50 mm	750 N	ITB
CTRI810HD	311955	620 mm	50 mm	625 N	ITB

A	B	C	D	X	Thickness
53.5 mm	43 mm	30 mm	6 mm	14 x 27 mm	1.5 mm

Metal Framing

NVENT CADDY ERISTRUT STRUT CHANNEL SYSTEM

INTERNAL CHANNEL WASHER

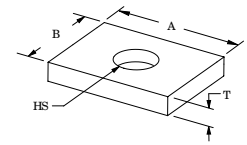
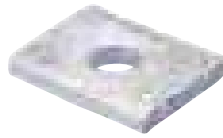

Material: Steel
Finish: Hot-Dip Galvanized

Part Number	Article Number	Hole Size	A	B	Thickness	Screw Included
ZEA101	387510	13 mm	40 mm	30 mm	6 mm	No

SADDLE WASHER

- U-shaped wrap around washer

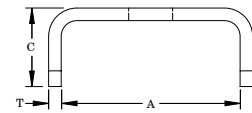
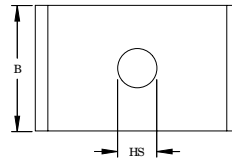

Part Number	Article Number	Hole Size	Thickness	A	B
Material: Stainless Steel 316 (EN 1.4401)					
PLN11S6	589928	11.0 mm	3 mm	42 mm	50 mm
PLN10S6	589927	10.5 mm	3 mm	42 mm	30 mm
PLN13S6	589921	13.0 mm	3 mm	42 mm	30 mm
Material: Steel – Finish: Electrogalvanized					
PLN8	589925	8.4 mm	3 mm	42 mm	30 mm
PLN10	589930	10.5 mm	3 mm	42 mm	30 mm
PLN13	589940	13.0 mm	3 mm	42 mm	30 mm
Material: Steel – Finish: Hot-Dip Galvanized					
PLN13HD	589949	13.0 mm	3 mm	42 mm	30 mm

SQUARE CHANNEL WASHER

- Use to secure objects to nVent CADDY Eristrut channels

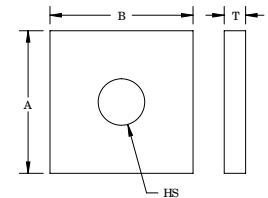
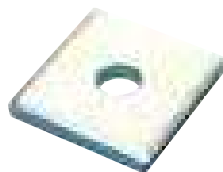

Part Number	Article Number	Hole Size	A	B	Thickness	Screw Included	Screw Diameter	Screw Length
Material: Stainless Steel 316 (EN 1.4401)								
ZEA100S6	388710	11 mm	40 mm	40 mm	4 mm	No		
Material: Steel – Finish: Hot-Dip Galvanized								
ZE100	313000	13 mm	40 mm	40 mm	6 mm	Yes	M10	25 mm
ZEA100	387500	13 mm	40 mm	40 mm	6 mm	No		

Metal Framing

nVENT CADDY ERISTRUT STRUT CHANNEL SYSTEM

TWO HOLE FLAT BRACKET



Part Number	Article Number	A	Screw Diameter	Screw Length	Screw Included
Material: Stainless Steel 316 (EN 1.4401)					
ZEA102S6	387522	83 mm			No
Material: Steel – Finish: Hot-Dip Galvanized					
ZE102	313020	83 mm	M10	25 mm	Yes
ZEA102	387520	83 mm			No

THREE HOLE FLAT ADJUSTABLE SWIVEL BRACKET

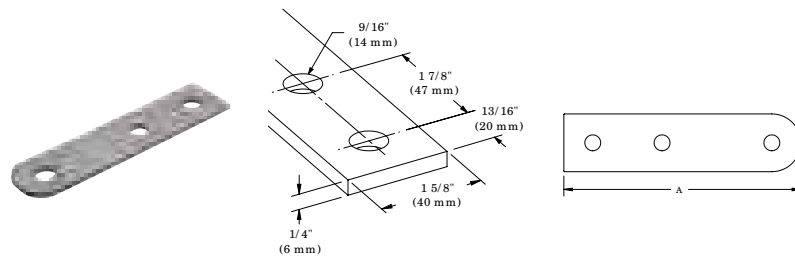

Material: Steel
Finish: Hot-Dip Galvanized

Part Number	Article Number	A
ZEA106	387560	164 mm

THREE HOLE FLAT BRACKET

- Used to create metal frames with nVent CADDY Eristrut channels

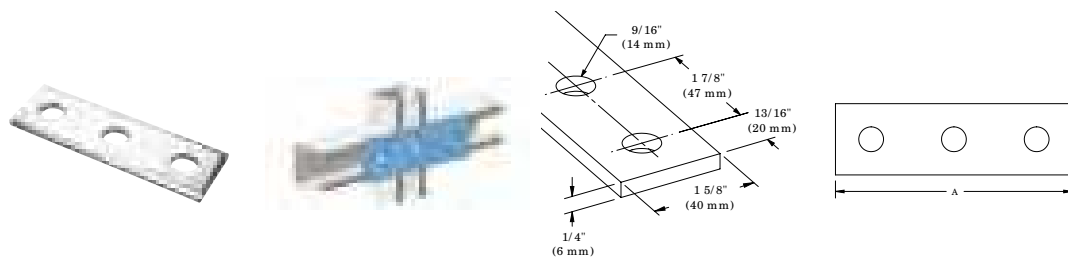

Part Number	Article Number	A
Material: Stainless Steel 316 (EN 1.4401)		
ZEA103S6	387532	136 mm
Material: Steel – Finish: Hot-Dip Galvanized		
ZEA103	387530	136 mm

Metal Framing

NVENT CADDY ERISTRUT STRUT CHANNEL SYSTEM

THREE HOLE FLAT CORNER BRACKET

- Used to create metal frames with nVent CADDY Eristrut channels

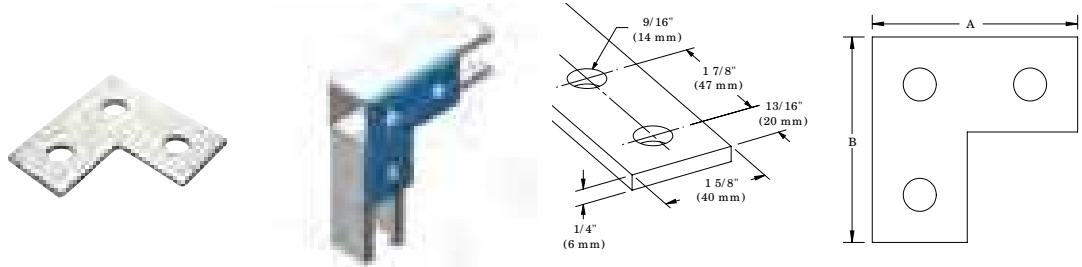

Part Number	Article Number	A	B	Screw Included	Screw Diameter	Screw Length
Material: Stainless Steel 316 (EN 1.4401)						
ZEA107S6	387572	85 mm	85 mm	No		
Material: Steel – Finish: Hot-Dip Galvanized						
ZE107	313070	85 mm	85 mm	Yes	M10	25 mm
ZEA107	387570	85 mm	85 mm	No		

FOUR HOLE FLAT BRACKET

- Used to create metal frames with nVent CADDY Eristrut channels

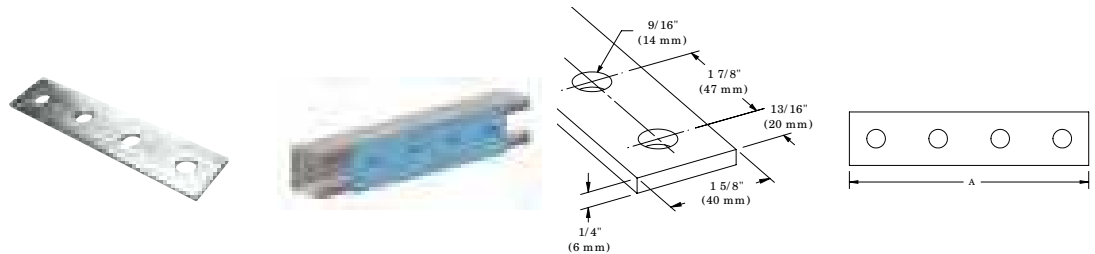

Part Number	Article Number	A	Screw Included	Screw Diameter	Screw Length
Material: Stainless Steel 316 (EN 1.4401)					
ZEA104S6	387542	168 mm	No		
Material: Steel – Finish: Hot-Dip Galvanized					
ZE104	313040	168 mm	Yes	M10	25 mm
ZEA104	387540	168 mm	No		

Metal Framing

nVENT CADDY ERISTRUT STRUT CHANNEL SYSTEM

FOUR HOLE FLAT GUSSET TEE BRACKET

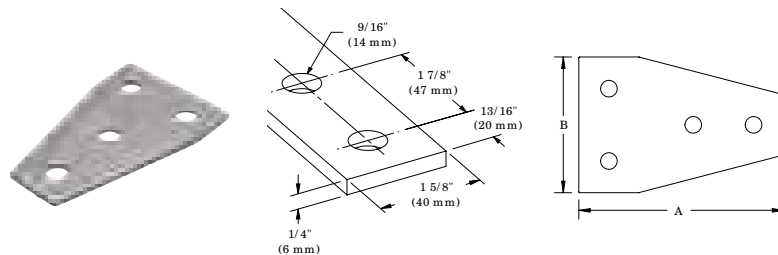

Material: Steel
Finish: Hot-Dip Galvanized

Part Number	Article Number	A	B
ZEA110	387450	132 mm	90 mm

FOUR HOLE FLAT TEE PLATE

- Used to create metal frames with nVent CADDY Eristrut channels

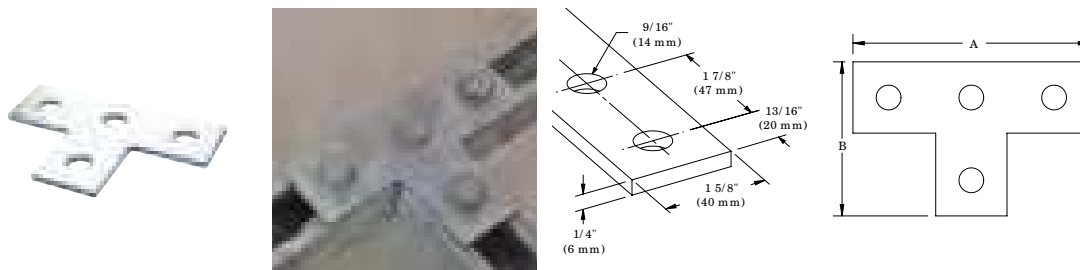

Part Number	Article Number	A	B	Screw Included	Screw Diameter	Screw Length
Material: Stainless Steel 316 (EN 1.4401)						
ZEA108S6	388701	138 mm	90 mm	No		
Material: Steel – Finish: Hot-Dip Galvanized						
ZE108	313080	138 mm	90 mm	Yes	M10	25 mm
ZEA108	387580	138 mm	90 mm	No		

FIVE HOLE FLAT BRACKET

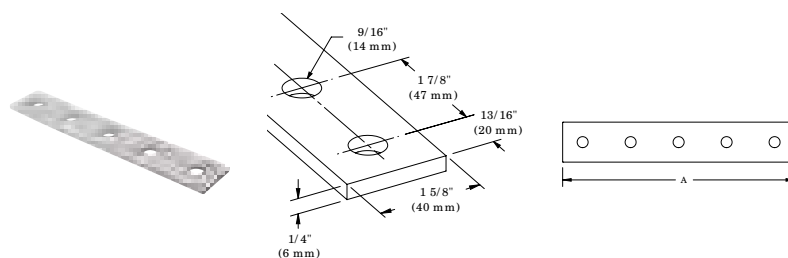

Material: Steel
Finish: Hot-Dip Galvanized

Part Number	Article Number	A
ZEA105	387550	210 mm

Metal Framing

nVent CADDY ERISTRUT STRUT CHANNEL SYSTEM

FIVE HOLE FLAT CROSS BRACKET

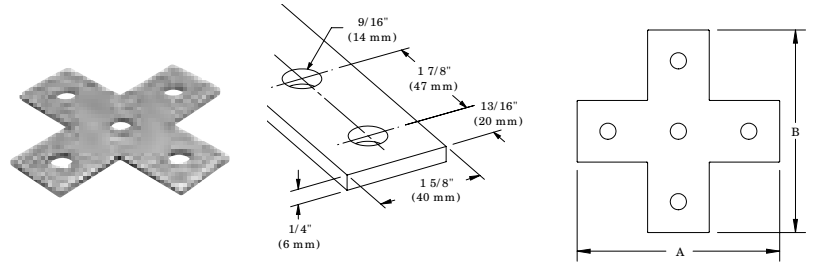

Material: Steel
Finish: Hot-Dip Galvanized

Part Number	Article Number	A	B
ZEA109	387590	138 mm	138 mm

1-1 HOLE ANGLE BRACKET

- Used to create metal frames with nVent CADDY Eristrut channels

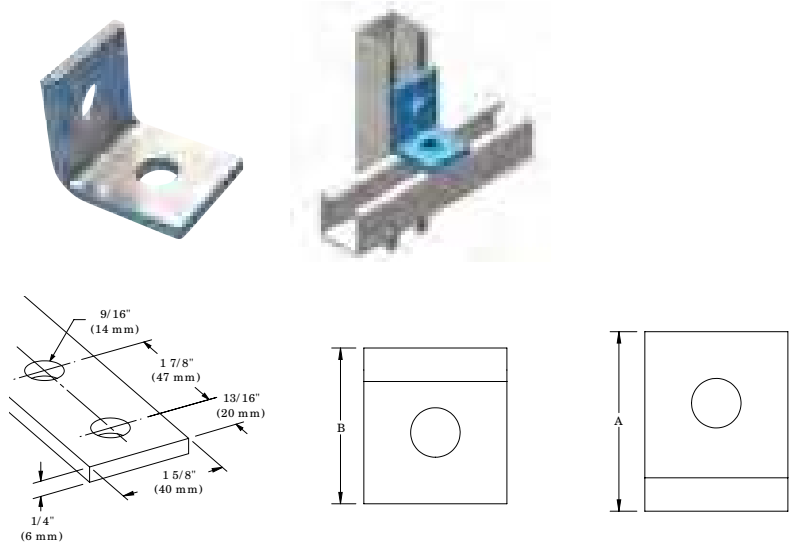

Part Number	Article Number	A	B	Screw Included	Screw Diameter	Screw Length
Material: Stainless Steel 316 (EN 1.4401)						
ZWA200S6	388670	50 mm	48 mm	No		
Material: Steel – Finish: Hot-Dip Galvanized						
ZW200	313330	50 mm	48 mm	Yes	M10	25 mm
ZW201	313340	58 mm	42 mm	Yes	M10	25 mm
ZWA200	387600	50 mm	48 mm	No		
ZWA201	387610	58 mm	42 mm	No		

Metal Framing

NVENT CADDY ERISTRUT STRUT CHANNEL SYSTEM

1-1 HOLE CLOSED CORNER ANGLE BRACKET

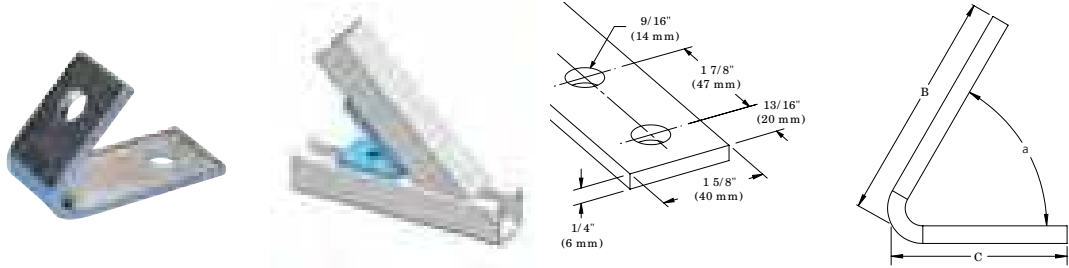

Material: Steel
Finish: Hot-Dip Galvanized

Part Number	Article Number	Angle	B	C	Screw Included	Screw Diameter	Screw Length
ZW219A45	313640	45°	100 mm	67 mm	Yes	M10	25 mm
ZWA219A45	387920	45°	100 mm	67 mm	No		

1-1 HOLE OPEN CORNER ANGLE BRACKET

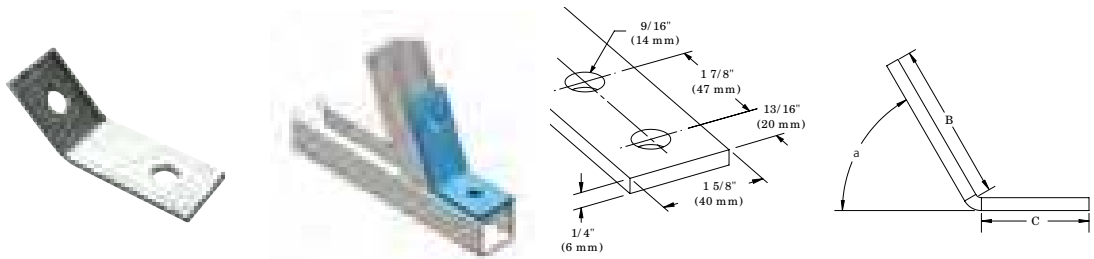

Material: Steel
Finish: Hot-Dip Galvanized

Part Number	Article Number	Angle	B	C
ZWA218A45	387850	45°	78 mm	53 mm

1-2 HOLE CORNER ANGLE BRACKET

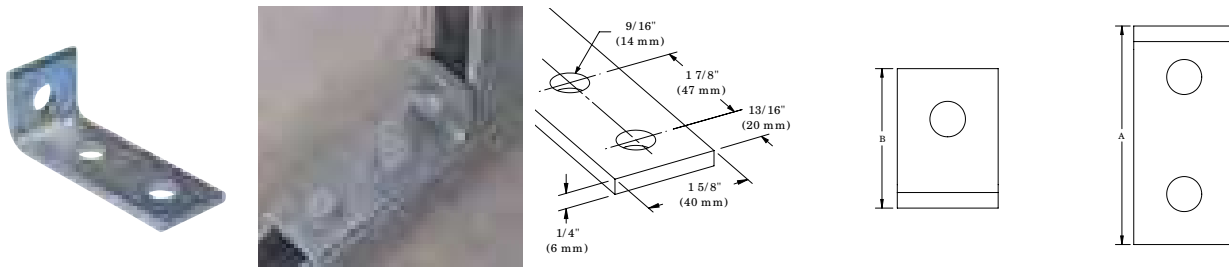

Material: Steel
Finish: Hot-Dip Galvanized

Part Number	Article Number	A	B
ZWA203	387630	99 mm	47 mm
ZWA204	387640	89 mm	57 mm

Metal Framing

NVENT CADDY ERISTRUT STRUT CHANNEL SYSTEM

1-2 HOLE CORNER SHORT ANGLE BRACKET

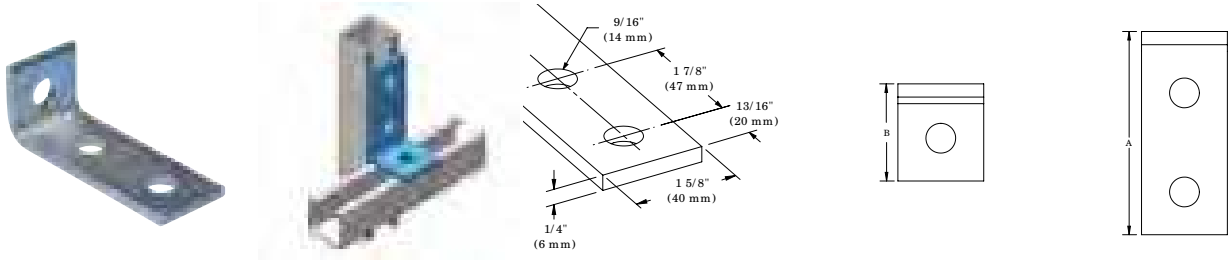

Part Number	Article Number	A	B	Screw Included	Screw Diameter	Screw Length
Material: Stainless Steel 316 (EN 1.4401)						
ZWA202S6	387625	103 mm	42 mm	No		
Material: Steel – Finish: Hot-Dip Galvanized						
ZW202	313350	103 mm	42 mm	Yes	M10	25 mm
ZWA202	387620	103 mm	42 mm	No		

1-2 HOLE OFFSET CORNER ANGLE BRACKET, LEFT

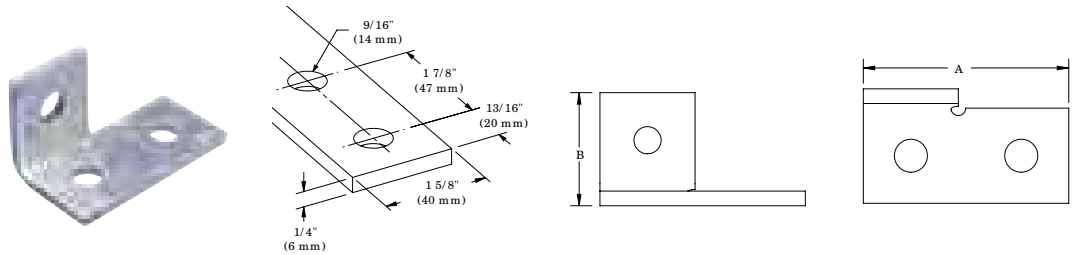

Material: Steel
Finish: Hot-Dip Galvanized

Part Number	Article Number	A	B
ZWA217	387930	90 mm	50 mm

1-2 HOLE OFFSET CORNER ANGLE BRACKET, RIGHT

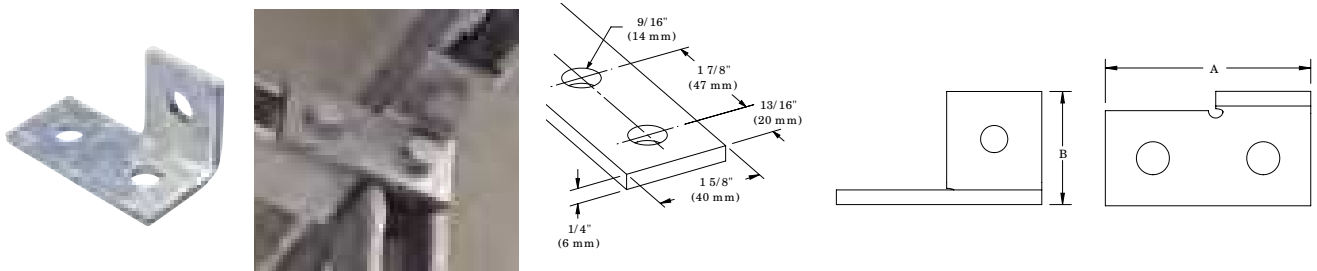

Material: Steel
Finish: Hot-Dip Galvanized

Part Number	Article Number	A	B
ZWA216	387910	90 mm	50 mm

Metal Framing

NVENT CADDY ERISTRUT STRUT CHANNEL SYSTEM

1-3 HOLE OFFSET CORNER ANGLE BRACKET, LEFT

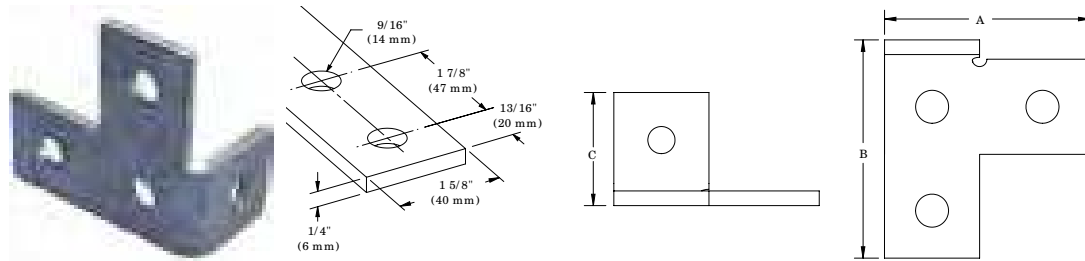

Material: Steel
Finish: Hot-Dip Galvanized

Part Number	Article Number	A	B	C
ZWA215	387900	90 mm	95 mm	50 mm

1-3 HOLE OFFSET CORNER ANGLE BRACKET, RIGHT

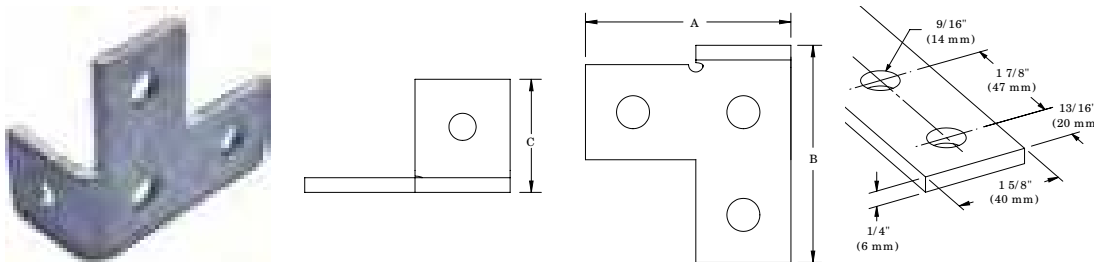

Material: Steel
Finish: Hot-Dip Galvanized

Part Number	Article Number	A	B	C
ZWA214	387890	90 mm	95 mm	50 mm

1-3 HOLE CORNER ANGLE BRACKET

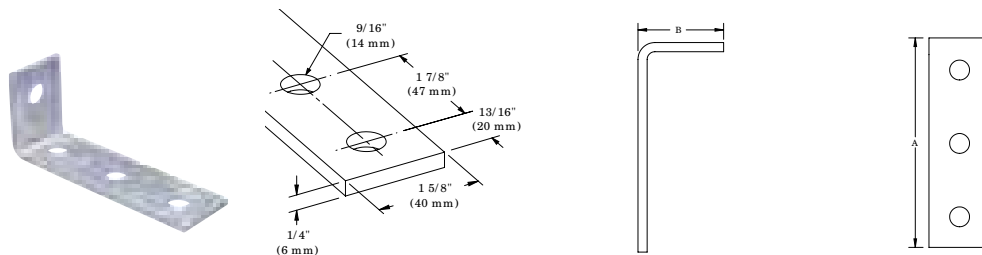

Material: Steel
Finish: Hot-Dip Galvanized

Part Number	Article Number	A	B
ZWA206	387660	132 mm	56 mm

Metal Framing

NVENT CADDY ERISTRUT STRUT CHANNEL SYSTEM

2-2 HOLE CORNER ANGLE BRACKET

- Used to create metal frames with nVent CADDY Eristrut channels

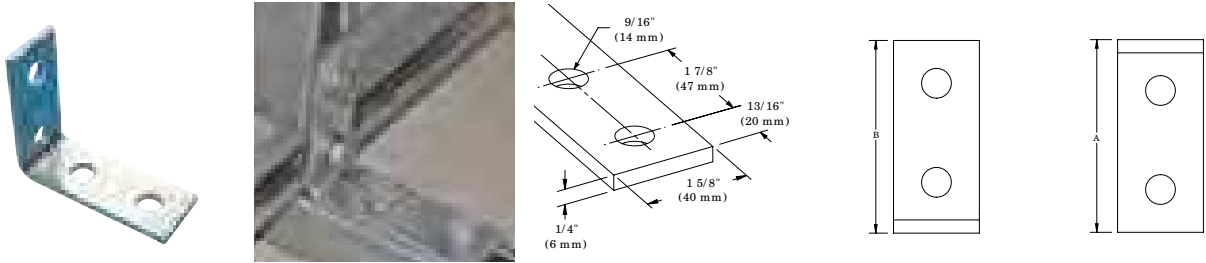

Part Number	Article Number	A	B	Screw Included	Screw Diameter	Screw Length
Material: Stainless Steel 316 (EN 1.4401)						
ZWA205S6	388761	102 mm	86 mm	No		
Material: Steel – Finish: Hot-Dip Galvanized						
ZW205	313380	102 mm	86 mm	Yes	M10	25 mm
ZWA205	387650	102 mm	86 mm	No		

2-2 HOLE CORNER 90° ANGLE BRACKET

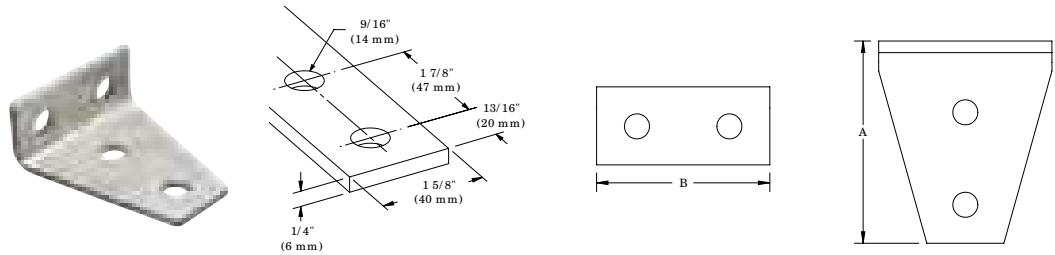

Material: Steel
Finish: Hot-Dip Galvanized

Part Number	Article Number	A	B
ZWA209	387690	105 mm	90 mm

2-2 HOLE IN-LINE CORNER 90° ANGLE BRACKET

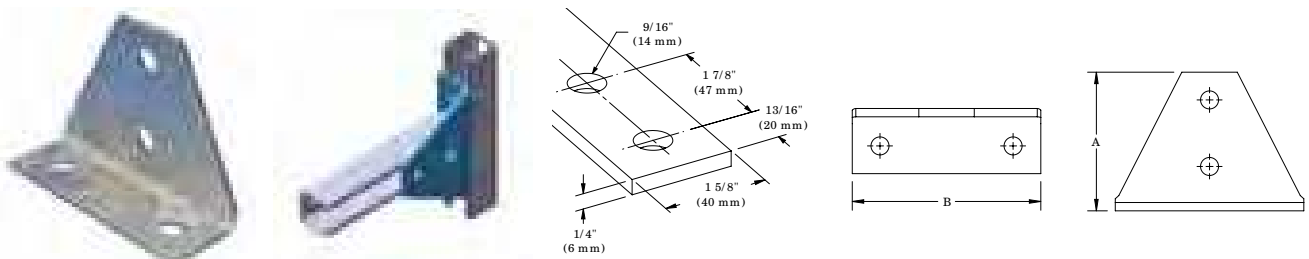

Material: Steel
Finish: Hot-Dip Galvanized

Part Number	Article Number	A	B
ZWA212	387870	100 mm	136 mm

Metal Framing

NVENT CADDY ERISTRUT STRUT CHANNEL SYSTEM

3-1 HOLE IN-LINE CORNER 90° ANGLE BRACKET

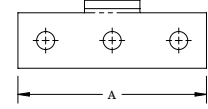
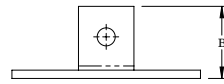
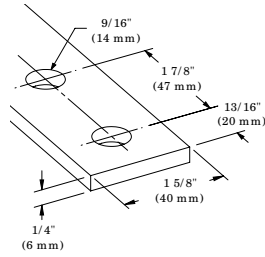

Material: Steel
Finish: Hot-Dip Galvanized

Part Number	Article Number	A	B
ZWA213	387880	136 mm	52 mm

2-2 HOLE CORNER GUSSET

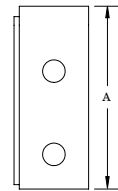
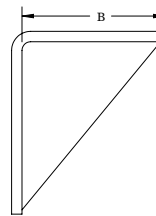
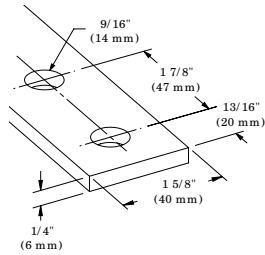

Material: Steel
Finish: Hot-Dip Galvanized

Part Number	Article Number	A	B	Screw Included	Screw Diameter	Screw Length
Orientation: Left Hand						
ZWA207L	387675	106 mm	89 mm	No		
Orientation: Right Hand						
ZW207	313400	106 mm	89 mm	Yes	M10	25 mm
ZWA207	387670	106 mm	89 mm	No		

2-2 HOLE OPEN CORNER ANGLE BRACKET

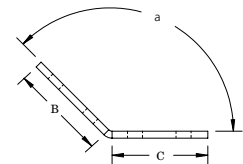
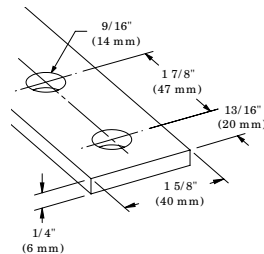

Material: Steel
Finish: Hot-Dip Galvanized

Part Number	Article Number	Angle	B	C	Screw Diameter	Screw Length	Screw Included
ZW220	313700	45°	87 mm	87 mm	M10	25 mm	Yes
ZWA220	387980	45°	87 mm	87 mm			No

Metal Framing

NVENT CADDY ERISTRUT STRUT CHANNEL SYSTEM

1-1 HOLE 45° ANGLE BRACE

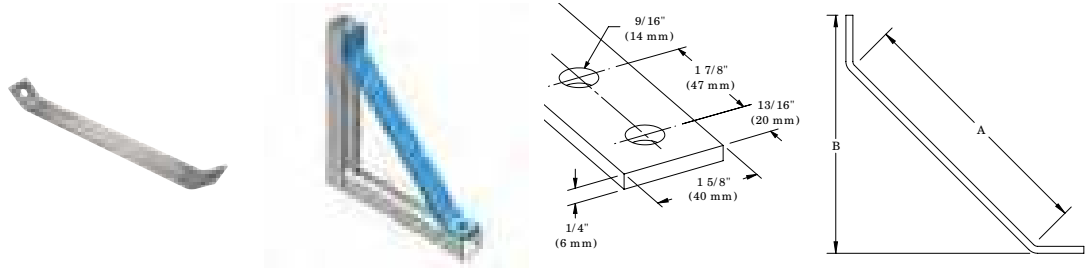

Material: Steel
Finish: Hot-Dip Galvanized

Part Number	Article Number	A	B
ZWA223	311840	368 mm	300 mm
ZWA225	311842	651 mm	500 mm

SIX HOLE SPECIAL CORNER CONNECTOR, 3-WAY

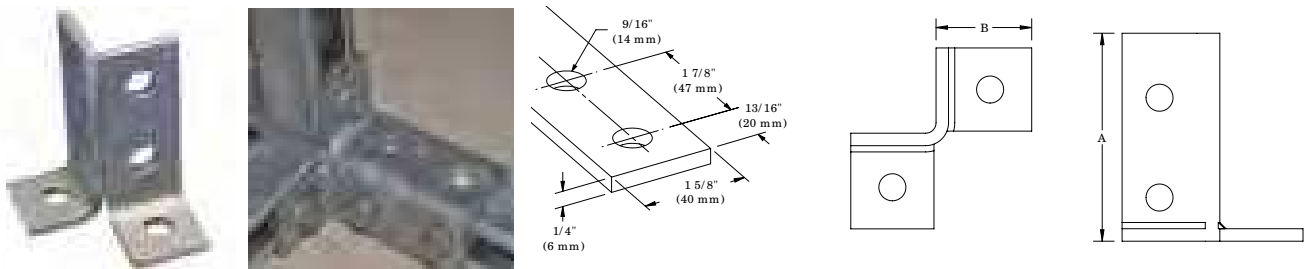

Material: Steel
Finish: Hot-Dip Galvanized

Part Number	Article Number	A	B
ZZA706	388422	100 mm	46 mm

SIX HOLE DOUBLE CORNER CONNECTOR, 3-WAY

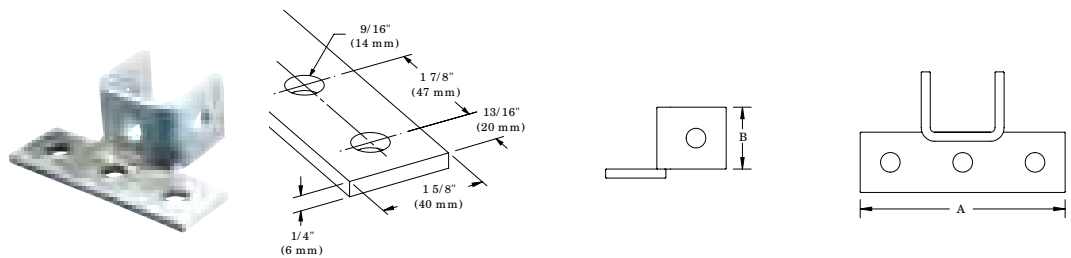

Material: Steel
Finish: Hot-Dip Galvanized

Part Number	Article Number	A	B
ZZA700	388390	138 mm	40 mm

Metal Framing

NVENT CADDY ERISTRUT STRUT CHANNEL SYSTEM

EIGHT HOLE DOUBLE CORNER CONNECTOR, 3-WAY

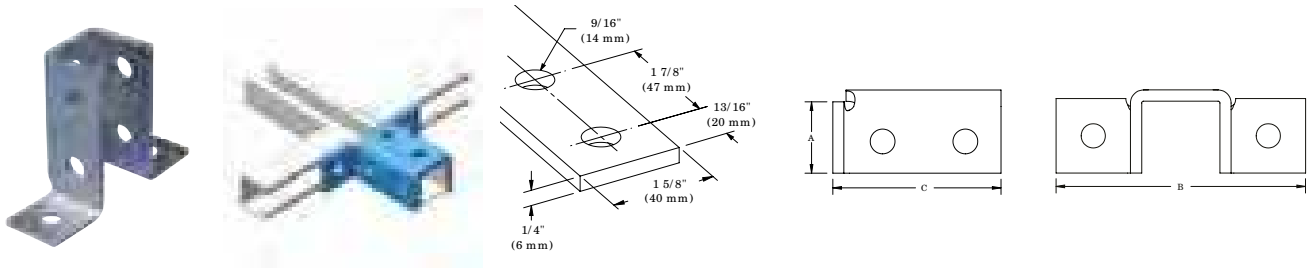

Material: Steel
Finish: Hot-Dip Galvanized

Part Number	Article Number	A	B	C	Screw Included	Screw Diameter	Screw Length
ZZ702	313850	43 mm	140 mm	102 mm	Yes	M10	25 mm
ZZA702	387720	43 mm	140 mm	102 mm	No		

NINE HOLE CORNER CONNECTOR, 3-WAY

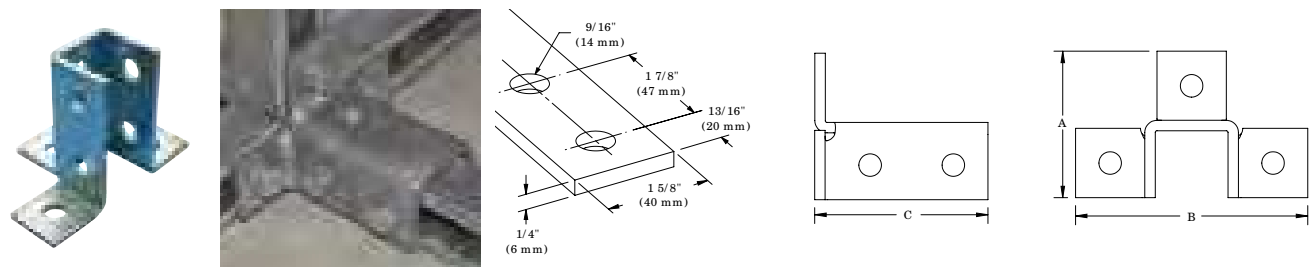

Material: Steel
Finish: Hot-Dip Galvanized

Part Number	Article Number	A	B	C
ZZA705	388421	87 mm	134 mm	100 mm

Metal Framing

NVENT CADDY ERISTRUT STRUT CHANNEL SYSTEM

STRUT BEAM CLAMP WITH U-BOLT

- Complete with U-bolt and nuts
- Requires installation in pairs

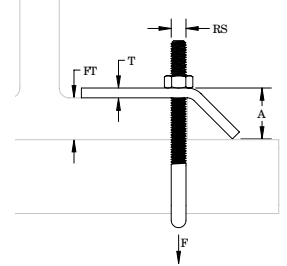
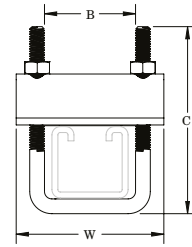
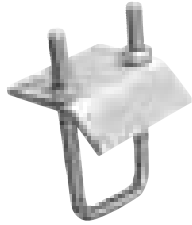

Part Number	Article Number	Strut Type	Rod Size	Flange Thickness	Width	Thickness	A	B	C	Static Load
Material: Stainless Steel 316 (EN 1.4401)										
ZTA601S6	387710	A (41 x 41 mm), C (21 x 41 mm), CC (41 x 41 mm)	M10	18 mm Max	80 mm	6 mm	24 mm	45 mm	110 mm	5,000 N
Material: Steel – Finish: Hot-Dip Galvanized										
ZTA601HD	387701	A (41 x 41 mm), C (21 x 41 mm), CC (41 x 41 mm)	M10	18 mm Max	80 mm	6 mm	24 mm	45 mm	95 mm	5,000 N
ZTA602HD	388006	A (41 x 41 mm), AA (83 x 41 mm), D (62 x 41 mm), E (83 x 41 mm)	M10	18 mm Max	80 mm	6 mm	24 mm	45 mm	140 mm	5,000 N
ZTA603HD	388066	DD (124 x 41 mm)	M10	18 mm Max	80 mm	6 mm	24 mm	45 mm	180 mm	5,000 N

Static Load is based on one pair of Strut Beam Clamps.

STRUT BEAM CLIP

- Beam Clip for clamping the open side of strut to a beam
- Suitable for all strut channels
- Requires installation in pairs
- Structural attachment to beams to support nVent CADDY Eristrut
- FM® Specification Tested

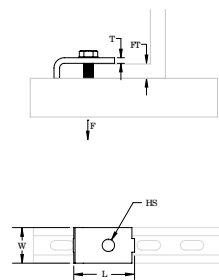
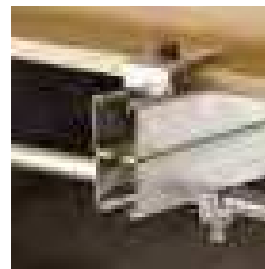

Part Number	Article Number	Flange Thickness	Hole Size	Length	Thickness	Width	Static Load	Screw Included
Material: Stainless Steel 316 (EN 1.4401)								
ZTA605S6	387190	16 mm Max	13 mm	49 mm	6 mm	40 mm	2,040 N	No
Material: Steel – Finish: Hot-Dip Galvanized								
ZT605HD	313260	16 mm Max	13 mm	49 mm	6 mm	40 mm	2,040 N	Yes
ZTA605	388080	16 mm Max	13 mm	49 mm	6 mm	40 mm	2,040 N	No

Indicated loads are based on installation with 1/2" (M12) hardware and strut channel type A.

Metal Framing

NVENT CADDY ERISTRUT STRUT CHANNEL SYSTEM

STRUT BEAM CLAMP WITH BOLT, WINDOW SHAPE

- Complete with bolt
- Requires installation in pairs

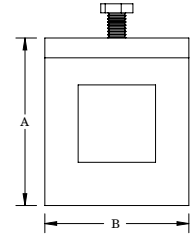
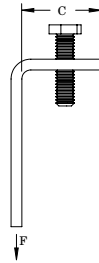

Material: Steel
Finish: Hot-Dip Galvanized

Part Number	Article Number	Strut Type	A	B	C	Static Load
ZZ704HDEG	313870	A (41 x 41 mm)	101 mm	90 mm	45 mm	3,290 N

EXTERNAL SIDE STRUT BEAM CLAMP

- Wrap around version
- Complete with fixings

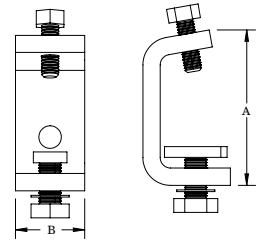

Material: Steel
Finish: Hot-Dip Galvanized

Part Number	Article Number	A	B
ZT607	313280	90 mm	40 mm

INTERNAL STRUT BEAM CLAMP WITH BOLT

- U-shaped clip for clamping the back of strut channel to a beam
- Hex bolt included
- Requires installation in pairs

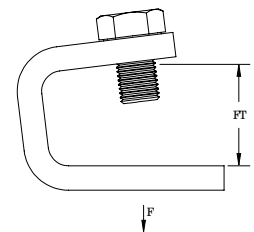
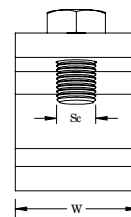
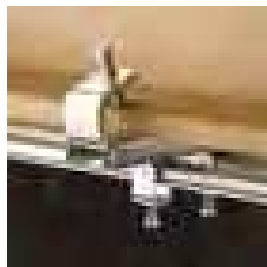

Material: Steel
Finish: Hot-Dip Galvanized, ElectroGalvanized

Part Number	Article Number	Flange Thickness	Width	Screw Diameter	Static Load
ZT606HDEG	313270	28 mm Max	30 mm	M10	2,900 N

Static Load is based on one pair of Strut Beam Clamps. Include strut channel thickness when calculating flange thickness.

Metal Framing

NVENT CADDY ERISTRUT STRUT CHANNEL SYSTEM

STRUT AND ROD BEAM CLAMP

- Multifunctional beam clamp suitable for strut channel or threaded rod
- Bolt included
- Requires installation in pairs

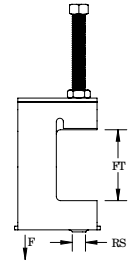
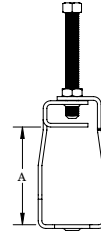
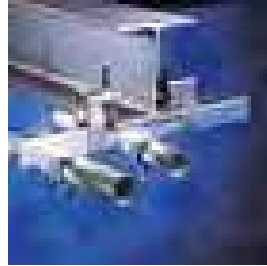

Material: Spring Steel
Finish: nVent CADDY Armour

Part Number	Article Number	Strut Type	Rod Size	Flange Thickness	A	Static Load
STCB10M	181580	A (41 x 41 mm), CC (41 x 41 mm)	M10	50 mm Max	71 mm	1,350 N

HEAVY DUTY STRUT BEAM CLAMP

- Suitable for strut mounting

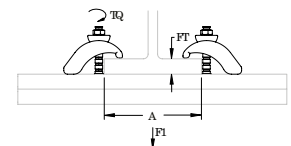
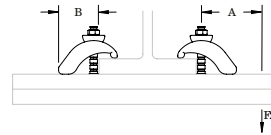
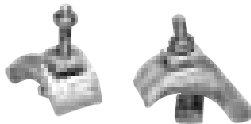

Part Number	Article Number	Flange Thickness	B	Torque
Material: Stainless Steel 304 (EN 1.4301)				
6120S4	330610	3 – 33 mm	60 mm	30 N-m
Material: Steel – Finish: Hot-Dip Galvanized				
6120HD	330600	3 – 33 mm	60 mm	30 N-m

Strut Type	A	Static Load 1 F1	Static Load 2 F2
CC	200 mm	4000 N	1100 N
	300 mm	3000 N	750 N
	400 mm	2250 N	550 N
	500 mm	1800 N	450 N
	600 mm	1500 N	350 N
AA	200 mm	7000 N	3250 N
	300 mm	7000 N	2250 N
	400 mm	7000 N	1750 N
	500 mm	5500 N	1400 N
	600 mm	4500 N	1150 N

Metal Framing

NVENT CADDY ERISTRUT STRUT CHANNEL SYSTEM

INC8 INTERNAL STRUT BEAM CLAMP

- Mounts strut within beams



Material: Spring Steel
Finish: nVent CADDY Armour

Part Number	Article Number	Strut Type	A	Screw Diameter	Screw Length	Torque	Static Load	Certifications	Standard Packaging Quantity
INC8	336290	A (41 x 41 mm), C (21 x 41 mm)	13 mm	M8	25 mm	6 N-m	450 N	ITB	100 pc

HIGH POST BASE FOR STRUT TYPE A WITH GUSSET

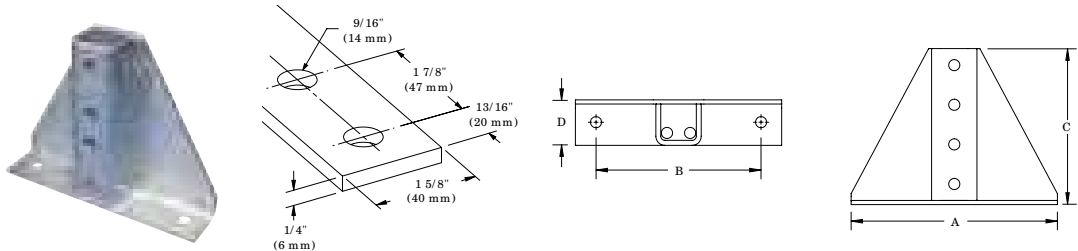

Material: Steel
Finish: Hot-Dip Galvanized

Part Number	Article Number	A	B	C	D
ZGA509	313825	250 mm	200 mm	190 mm	55 mm

OPEN POST BASE FOR STRUT TYPE A WITH GUSSET



Material: Steel
Finish: Hot-Dip Galvanized

Part Number	Article Number	Strut Type	A	B
ZGA503	388370	A (41 x 41 mm)	216 mm	152 mm
ZGA504	388380	AA (83 x 41 mm)	256 mm	152 mm

Metal Framing

NVENT CADDY ERISTRUT STRUT CHANNEL SYSTEM

POST BASE FOR STRUT TYPE A WITH GUSSET

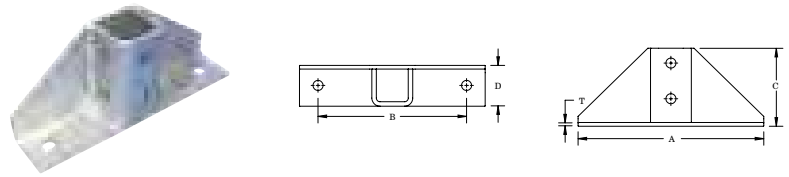

Material: Steel
Finish: Hot-Dip Galvanized

Part Number	Article Number	A	B	C	D	Thickness
ZGA510	313826	250 mm	200 mm	106 mm	55 mm	5 mm

POST BASE FOR STRUT TYPE A

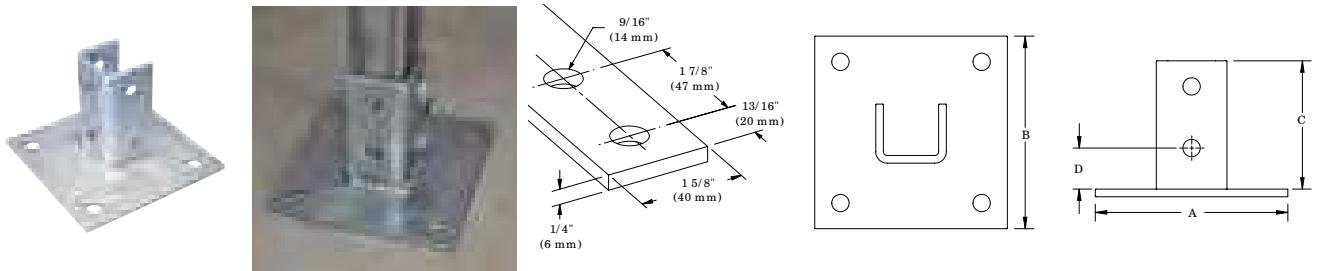

Material: Steel
Finish: Hot-Dip Galvanized

Part Number	Article Number	A	B	C	D
ZGA506	313822	150 mm	150 mm	100 mm	32 mm

POST BASE FOR STRUT TYPE AA

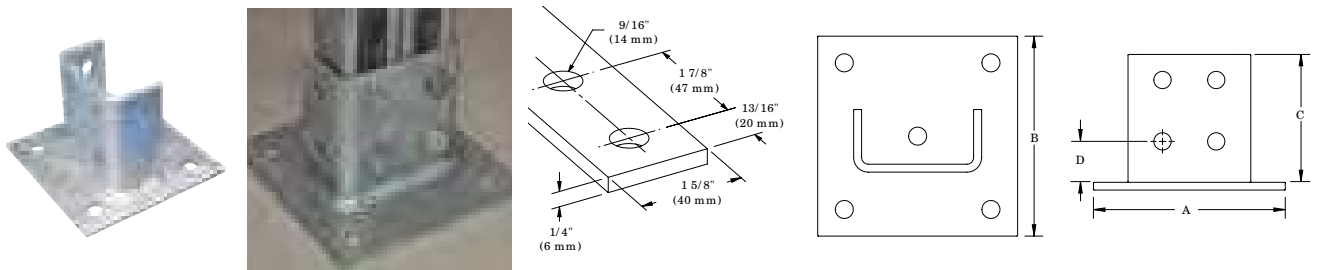

Material: Steel
Finish: Hot-Dip Galvanized

Part Number	Article Number	A	B	C	D
ZGA508	313824	150 mm	150 mm	100 mm	32 mm

Metal Framing

NVENT CADDY ERISTRUT STRUT CHANNEL SYSTEM

45° POST BASE FOR STRUT TYPE AA

- Post base to create metal frames for attachment to nVent CADDY Eristrut or nVent CADDY Pyramid

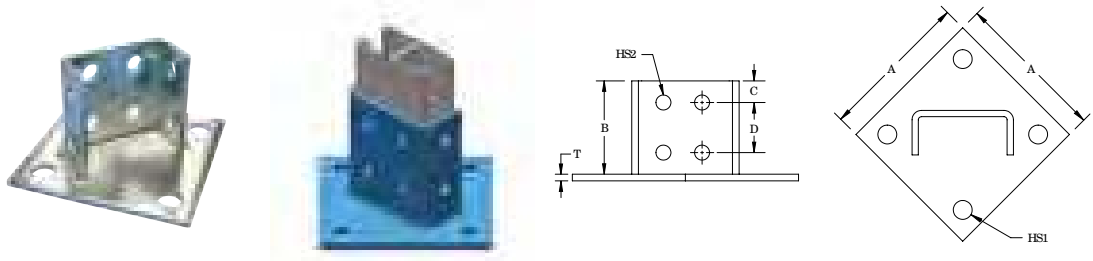

Material: Steel
Finish: Hot-Dip Galvanized

Part Number	Article Number	A	B	C	D	Thickness	Hole Size 1	Hole Size 2
ZGA507	313823	150 mm	100 mm	20 mm	48 mm	6 mm	13.5 mm	13.5 mm

RECTANGULAR POST BASE PLATE

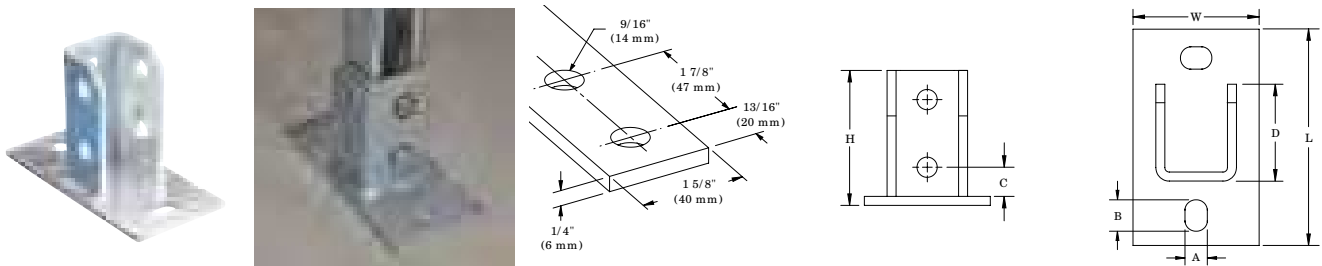

Material: Steel
Finish: Hot-Dip Galvanized

Part Number	Article Number	Height	Length	Width	A	B	C	D
ZGA512	313828	100 mm	160 mm	80 mm	14 mm	20 mm	32 mm	51 mm

LOW POST BASE FOR STRUT TYPES AA/E

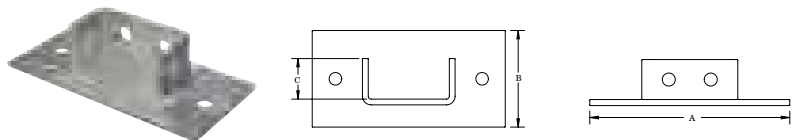

Material: Steel
Finish: Hot-Dip Galvanized

Part Number	Article Number	Strut Type	A	B	C
ZGA502	388360	AA (83 x 41 mm), E (83 x 41 mm)	200 mm	100 mm	40 mm

Metal Framing

NVENT CADDY ERISTRUT STRUT CHANNEL SYSTEM

POST BASE PLATE, 1-1 HOLE ANGLE

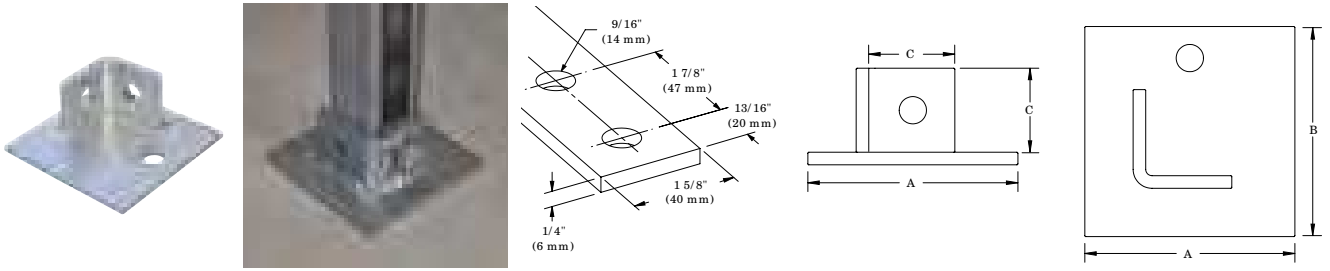

Material: Steel
Finish: Hot-Dip Galvanized

Part Number	Article Number	A	B	C
ZGA501	388270	100 mm	100 mm	40 mm

POST BASE PLATE, 1-1 HOLE ANGLE CORNER

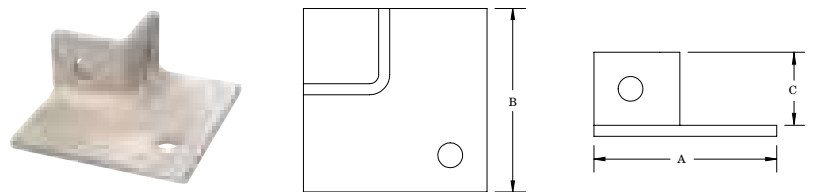

Material: Steel
Finish: Hot-Dip Galvanized

Part Number	Article Number	A	B	C
ZGA505	313821	100 mm	100 mm	40 mm

FOUR HOLE EXTERNAL COUPLER



Material: Steel
Finish: Hot-Dip Galvanized

Part Number	Article Number	Strut Type	Hole Size	Thickness	A	B	C
ZUA406	387810	C (21 x 41 mm)	13 mm	6 mm	184 mm	20 mm	48 mm
ZUA407	387820	A (41 x 41 mm)	13 mm	6 mm	184 mm	20 mm	48 mm

Metal Framing

NVENT CADDY ERISTRUT STRUT CHANNEL SYSTEM

INTERNAL CHANNEL CONNECTOR

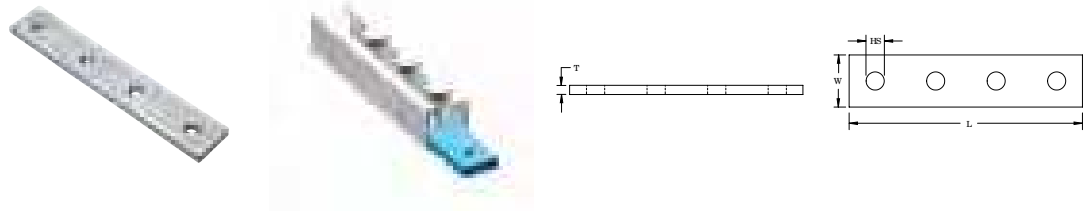

Material: Steel
Finish: Hot-Dip Galvanized

Part Number	Article Number	Hole Size	Length	Width	Thickness
ZUA408	387830	M12	203 mm	35 mm	10 mm

INTERNAL U-SHAPED COUPLER

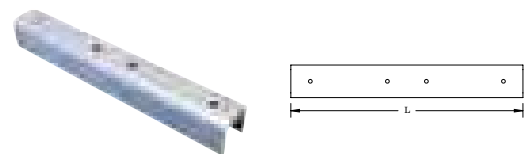

Material: Steel

Part Number	Article Number	Strut Type	Length	Screw Included	Screw Diameter	Screw Length
Finish: Hot-Dip Galvanized						
ZUA404	387790	C (21 x 41 mm)	250 mm	No		
ZUA405	387800	A (41 x 41 mm)	250 mm	No		
Finish: Pregalvanized						
ZU405PG	387805	A (41 x 41 mm)	250 mm	Yes	M6	12 mm

SWIVEL POST BASE BRACKET FOR STRUT TYPE A

- Suitable for sloped walls and ceilings
- Two bolts and nuts included

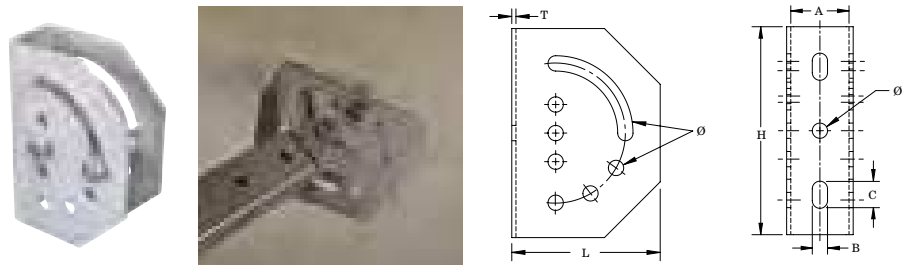

Material: Steel

Part Number	Article Number	Height	Length	Thickness	Diameter	A	B	C
Finish: ElectroGalvanized								
SNAEG	311905	150 mm	106 mm	3 mm	11 mm	42 mm	11 mm	20 mm
Finish: Hot-Dip Galvanized								
SNAHD	311900	150 mm	106 mm	3 mm	11 mm	42 mm	11 mm	20 mm

Metal Framing

NVENT CADDY ERISTRUT STRUT CHANNEL SYSTEM

SWIVEL ATTACHMENT FOR STRUT TYPE AS

- Loose swivel adapter for strut mounting



Material: Steel
Finish: Electrogalvanized

Part Number	Article Number
6000HBEG	388350

2-2 HOLE ADJUSTABLE STRUT SWIVEL BRACKET

- Strut to strut applications for seismic bracing

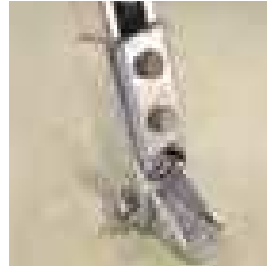

Material: Steel
Finish: Hot-Dip Galvanized

Part Number	Article Number	Hole Size	Strut Type
ZAA180	388901	14.3 mm	A (41 x 41 mm)

1-1 HOLE SWIVEL BRACKET

- Threaded rod to strut applications for bracing and support
- Allows for angled installation of threaded rod or strut from walls or ceilings
- Swivel allows for adjustable angles up to 90°

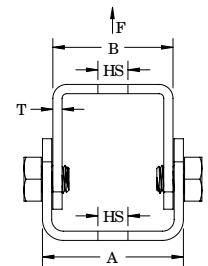
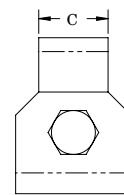

Material: Steel
Finish: Hot-Dip Galvanized

Part Number	Article Number	Hole Size	A	B	C	Thickness	Static Load
ZRA180	388906	13 mm	61 mm	52 mm	30 mm	4 mm	4,000 N

Metal Framing

NVENT CADDY ERISTRUT STRUT CHANNEL SYSTEM

STRUT TRAPEZE ATTACHMENT PLATE

- Creates fast install trapeze brackets
- Includes hex bolt and strut nut

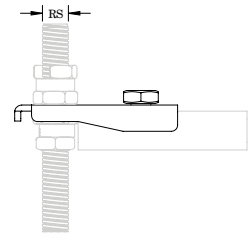
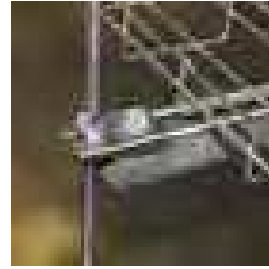

Material: Steel
Finish: Electrogalvanized

Part Number	Article Number	Rod Size
ISSP	190800	M6, M8, M10

U-SHAPED BRACKET FOR STRUT TYPE A

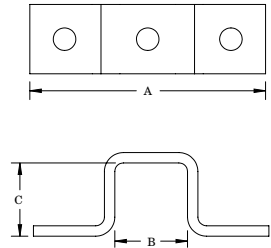
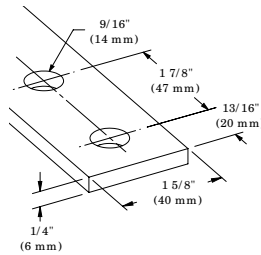

Material: Steel
Finish: Hot-Dip Galvanized

Part Number	Article Number	A	B	C	Screw Included	Screw Diameter	Screw Length
ZU400	313120	136 mm	42 mm	41 mm	Yes	M10	25 mm
ZUA400	387750	136 mm	42 mm	41 mm	No		

U-SHAPED BRACKET FOR STRUT TYPES AA/E

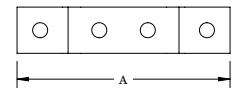
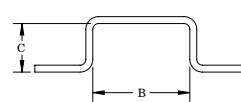
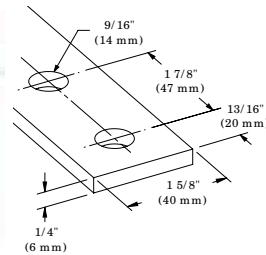

Material: Steel
Finish: Hot-Dip Galvanized

Part Number	Article Number	A	B	C
ZUA402	387770	184 mm	84 mm	42 mm

Metal Framing

NVENT CADDY ERISTRUT STRUT CHANNEL SYSTEM

U-SHAPED BRACKET FOR STRUT TYPES AA/E, BACK-TO-BACK

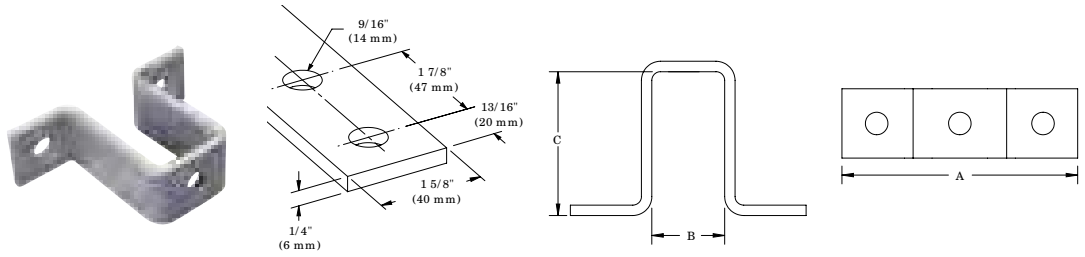

Material: Steel
Finish: Hot-Dip Galvanized

Part Number	Article Number	A	B	C
ZUA403	387780	136 mm	42 mm	83 mm

U-SHAPED BRACKET FOR STRUT TYPE C

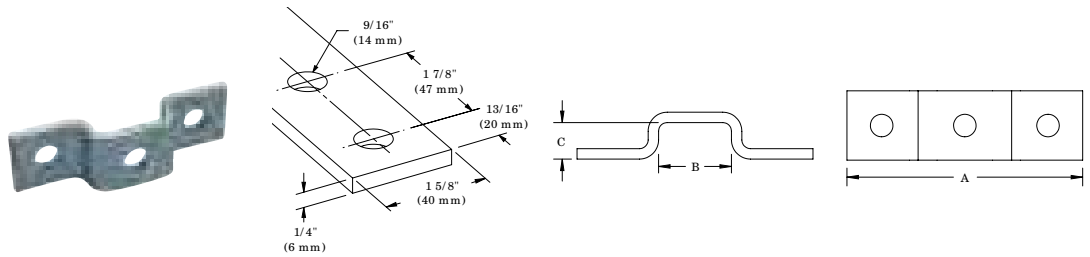

Material: Steel
Finish: Hot-Dip Galvanized

Part Number	Article Number	A	B	C
ZUA401	387760	136 mm	42 mm	21 mm

Z-SHAPED BRACKET FOR STRUT TYPE A

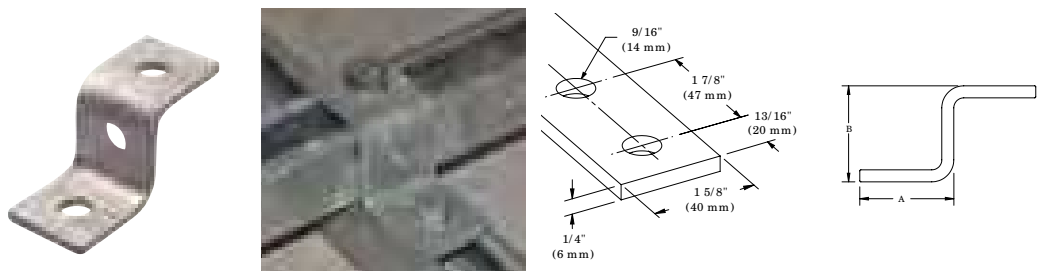

Part Number	Article Number	A	B
Material: Stainless Steel 316 (EN 1.4401)			
ZSA301S6	387742	48 mm	43 mm
Material: Steel – Finish: Hot-Dip Galvanized			
ZSA301	387740	48 mm	43 mm

Metal Framing

NVENT CADDY ERISTRUT STRUT CHANNEL SYSTEM

Z-SHAPED BRACKET FOR STRUT TYPE AA/E

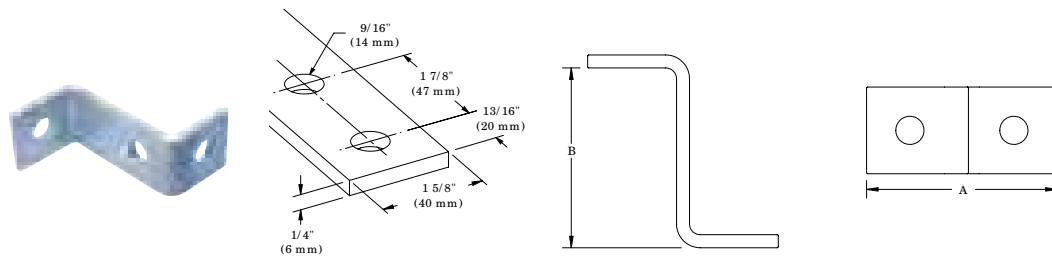

Material: Steel
Finish: Hot-Dip Galvanized

Part Number	Article Number	A	B
ZSA302	387960	90 mm	84 mm

Z-SHAPED BRACKET FOR STRUT TYPE C

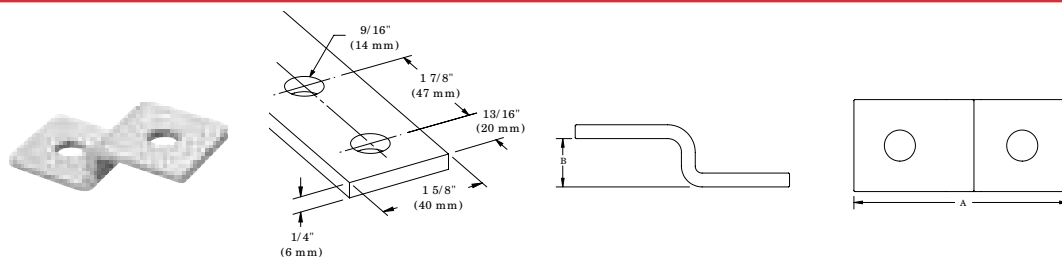

Material: Steel
Finish: Hot-Dip Galvanized

Part Number	Article Number	A	B
ZSA300	387730	90 mm	21 mm

Z-SHAPED OFFSET BRACKET FOR STRUT TYPE A

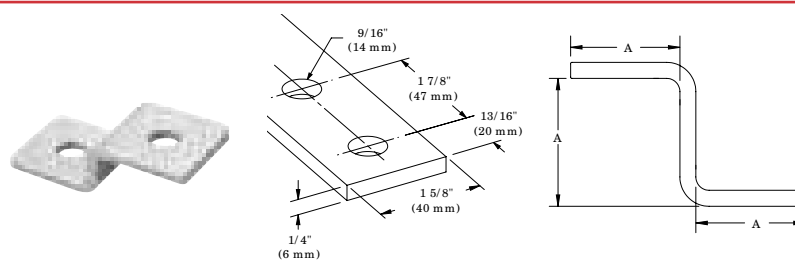

Material: Steel
Finish: Hot-Dip Galvanized

Part Number	Article Number	A
ZSA303	387970	42 mm

Metal Framing

NVENT CADDY ERISTRUT STRUT CHANNEL SYSTEM

ESC STRUT ATTACHMENT CLIP

- Attaches to open side of a strut channel
- Designed to accept nVent CADDY Speed Link wire rope or hook

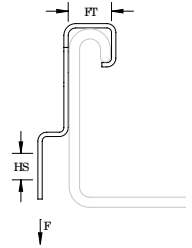

Material: Spring Steel
Finish: nVent CADDY Armour

Part Number	Article Number	Flange Thickness	Hole Size	Hole Type	Static Load
ESC4	174560	10 mm	6.12 mm	Plain	670 N

C-CHANNEL TYPE E0L, PERFORATED

- Perforated, cold rolled

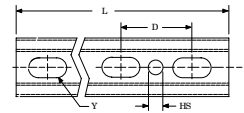
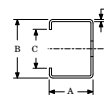
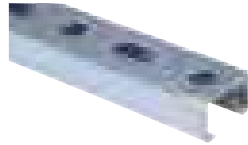

Material: Steel
Finish: Pregalvanized

Part Number	Article Number	Length	A	B	C	D	Y	Thickness	Hole Size	Certifications
E0L13H2000PG	599996	1,980 mm	18 mm	27 mm	15.5 mm	60 mm	8.5 x 20 mm	1.25 mm	10.5 mm	ITB

C-CHANNEL TYPE E0, PERFORATED

- Perforated, cold rolled

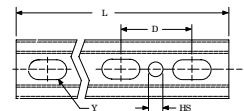
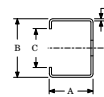
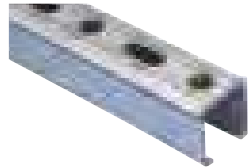

Material: Steel
Finish: Pregalvanized

Part Number	Article Number	Length	A	B	C	D	Y	Thickness	Hole Size	Certifications
E015H2000PG	599997	1,980 mm	30 mm	27 mm	15.5 mm	60 mm	8.5 x 20 mm	1.5 mm	10.5 mm	ITB

C-CHANNEL TYPE E1, PERFORATED

- Perforated, cold rolled

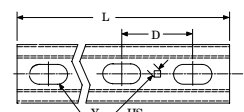
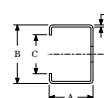

Material: Steel
Finish: Pregalvanized

Part Number	Article Number	Length	A	B	C	D	Y	Thickness	Hole Size	Certifications
E120H2000PG	585500	2,000 mm	15 mm	30 mm	15.5 mm	50 mm	11 x 27 mm	2 mm	5 mm	ITB

Metal Framing

C-CHANNEL SYSTEM

C-CHANNEL TYPE E2L, PERFORATED

- Perforated, cold rolled

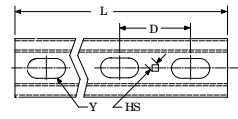
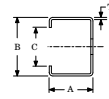

Material: Steel
Finish: Pregalvanized

Part Number	Article Number	Length	A	B	C	D	Y	Thickness	Hole Size	Certifications
E2L15H2000PG	585480	2,000 mm	20 mm	34 mm	15.5 mm	50 mm	11 x 27 mm	1.5 mm	5 mm	ITB

C-CHANNEL TYPE E3, PERFORATED

- Perforated, cold rolled

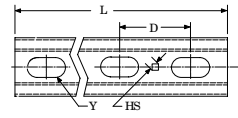
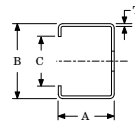

Material: Steel
Finish: Pregalvanized

Part Number	Article Number	Length	A	B	C	D	Y	Thickness	Hole Size	Certifications
E320H2000PG	585560	2,000 mm	35 mm	35 mm	15.5 mm	50 mm	11 x 27 mm	2 mm	5 mm	ITB
E320H3000PG	585550	3,000 mm	35 mm	35 mm	15.5 mm	50 mm	11 x 27 mm	2 mm	5 mm	ITB

Metal Framing

C-CHANNEL SYSTEM

C-CHANNEL TYPE E4, PERFORATED

- Perforated, cold rolled

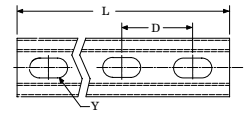
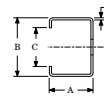

Material: Steel
Finish: Pregalvanized

Part Number	Article Number	Length	A	B	C	D	Y	Thickness	Certifications
E420H2000PG	599998	2,000 mm	40 mm	38 mm	15.5 mm	50 mm	14 x 27 mm	2 mm	ITB
E420H3000PG	600000	3,000 mm	40 mm	38 mm	15.5 mm	50 mm	14 x 27 mm	2 mm	ITB
E420H6000PG	599999	6,000 mm	40 mm	38 mm	15.5 mm	50 mm	14 x 27 mm	2 mm	ITB

C-CHANNEL TYPE E5, PERFORATED

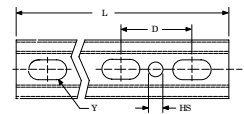
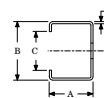

Part Number	Article Number	Length	A	B	C	D	Y	Thickness	Hole Size
Material: Stainless Steel 304 (EN 1.4301)									
E530H0400S4	335600	400 mm	20 mm	36 mm	14 mm	60 mm	11 x 20 mm	3 mm	11 mm
E530H0600S4	335620	600 mm	20 mm	36 mm	14 mm	60 mm	11 x 20 mm	3 mm	11 mm
E530H1000S4	335640	1,000 mm	20 mm	36 mm	14 mm	60 mm	11 x 20 mm	3 mm	11 mm
E530H2000S4	335650	2,000 mm	20 mm	36 mm	14 mm	60 mm	11 x 20 mm	3 mm	11 mm
E530H3000S4	335660	3,000 mm	20 mm	36 mm	14 mm	60 mm	11 x 20 mm	3 mm	11 mm
E530H6000S4	335670	6,000 mm	20 mm	36 mm	14 mm	60 mm	11 x 20 mm	3 mm	11 mm
Material: Steel – Finish: Hot-Dip Galvanized									
E530H0300HD	335500	300 mm	20 mm	36 mm	14 mm	60 mm	11 x 20 mm	3 mm	14 mm
E530H0400HD	335510	400 mm	20 mm	36 mm	14 mm	60 mm	11 x 20 mm	3 mm	14 mm
E530H0500HD	335520	500 mm	20 mm	36 mm	14 mm	60 mm	11 x 20 mm	3 mm	14 mm
E530H0600HD	335530	600 mm	20 mm	36 mm	14 mm	60 mm	11 x 20 mm	3 mm	14 mm
E530H0800HD	335540	800 mm	20 mm	36 mm	14 mm	60 mm	11 x 20 mm	3 mm	14 mm
E530H1000HD	335550	1,000 mm	20 mm	36 mm	14 mm	60 mm	11 x 20 mm	3 mm	14 mm
E530H2000HD	335560	2,000 mm	20 mm	36 mm	14 mm	60 mm	11 x 20 mm	3 mm	14 mm
E530H3000HD	335570	3,000 mm	20 mm	36 mm	14 mm	60 mm	11 x 20 mm	3 mm	14 mm
E530H6000HD	335580	6,000 mm	20 mm	36 mm	14 mm	60 mm	11 x 20 mm	3 mm	14 mm

Metal Framing

C-CHANNEL SYSTEM

ADK PLASTIC END CAP FOR C-CHANNEL

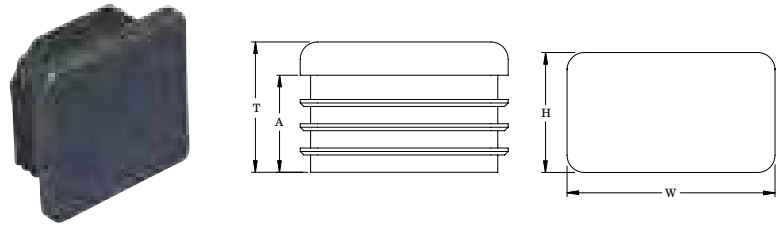

Material: Polyvinylchloride

Part Number	Article Number	Channel Type	Height	Width	Thickness	A
ADKE0L	313301	E0L	20 mm	30 mm	16.8 mm	11.8 mm
ADKE0	313302	E0	30 mm	30 mm	19.0 mm	14.2 mm
ADKE1	585380	E1	15 mm	30 mm	16.5 mm	11.5 mm
ADKE2	313304	E2L, E2	20 mm	35 mm	16.5 mm	11.5 mm
ADKE3	585400	E3	35 mm	35 mm	19.5 mm	14.5 mm
ADKE4	313303	E4	40 mm	40 mm	23.2 mm	17.8 mm

C-FIX NUT/WASHER

- C-Fix quick fit channel nut
- Suitable for C-Profiles 0-4

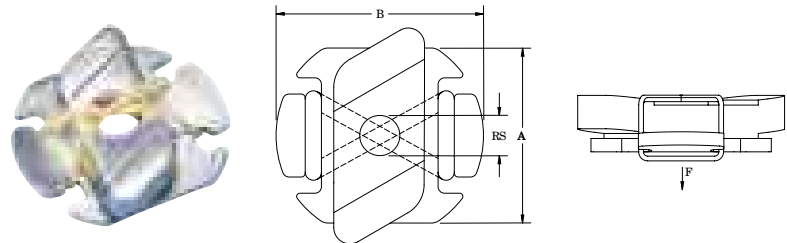

Material: Steel
Finish: Electrogalvanized

Part Number	Article Number	Rod Size	A	B	Static Load
CFIXM8	584510	M8	27 mm	32 mm	300 N
CFIXM10	584520	M10	27 mm	32 mm	300 N

Metal Framing

C-CHANNEL SYSTEM

C-FIX M T-BOLT

- C-Fix quick fit T-bolt
- Suitable for C-Profiles 0-4

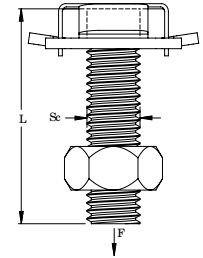
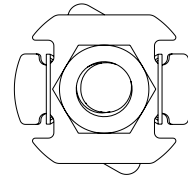

Material: Steel
Finish: Electrogalvanized

Part Number	Article Number	Screw Diameter	Screw Length	Static Load
CFIXM8030	584530	M8	30 mm	300 N
CFIXM8040	584540	M8	40 mm	300 N
CFIXM8060	584550	M8	60 mm	300 N
CFIXM10040	584560	M10	40 mm	300 N

KP T-BOLT FOR C-CHANNEL E0/E0L/E1

- For use with C-Profiles
- Pre-mounted with large washer and nut

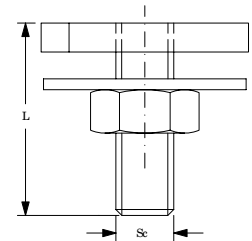
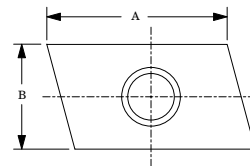

Channel Type: E0, E0L, E1
Material: Steel
Finish: Electrogalvanized

Part Number	Article Number	Screw Diameter	Screw Length	A	B
KP2708020	590074	M8	20 mm	25 mm	14 mm
KP2708030	590076	M8	30 mm	25 mm	14 mm
KP2708040	590077	M8	40 mm	25 mm	14 mm
KP2708080	590082	M8	80 mm	25 mm	14 mm
KP2710030	590087	M10	30 mm	25 mm	14 mm

Metal Framing

C-CHANNEL SYSTEM

KP T-BOLT FOR C-CHANNEL E2/E2L/E3

- For use with C-Profiles
- Pre-mounted with large washer and nut

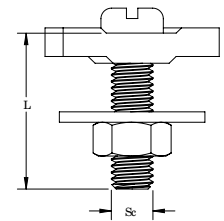
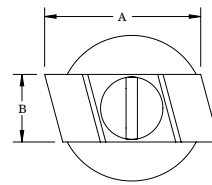

Channel Type: E2, E2L, E3
Material: Steel
Finish: Electrogalvanized

Part Number	Article Number	Screw Diameter	Screw Length	A	B
KP3408030	585050	M8	30 mm	29 mm	13 mm
KP3408050	585060	M8	50 mm	29 mm	13 mm
KP3408060	585010	M8	60 mm	29 mm	13 mm

KP T-BOLT FOR C-CHANNEL E4

- For use with C-Profiles
- Pre-mounted with large washer and nut

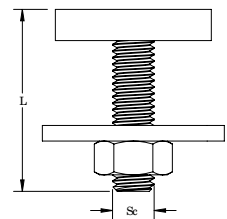
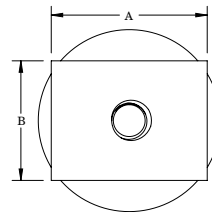

Channel Type: E4
Material: Steel
Finish: Electrogalvanized

Part Number	Article Number	Screw Diameter	Screw Length	A	B
KP3808025	590201	M8	25 mm	30 mm	23 mm
KP3808040	590210	M8	40 mm	30 mm	23 mm
KP3810035	590207	M10	35 mm	30 mm	23 mm
KP3810050	590330	M10	50 mm	30 mm	23 mm

ECN UNIVERSAL NUT

- Universal channel nut for C-Profiles

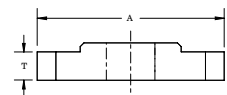
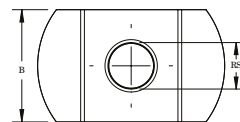
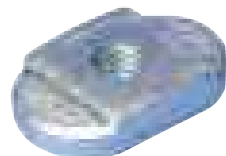

Material: Steel
Finish: Electrogalvanized

Part Number	Article Number	Channel Type	Rod Size	Thickness	A	B
ECNUNI06	585430	E0, E1, E2, E2L, E3	M6	4 mm	24 mm	15 mm
ECNUNI08	585440	E0, E1, E2, E2L, E3	M8	4 mm	24 mm	15 mm
ECNUNI10	585450	E0, E1, E2, E2L, E3	M10	4 mm	24 mm	15 mm

Metal Framing

C-CHANNEL SYSTEM

ECN NUT FOR C-CHANNEL E0/E0L/E1

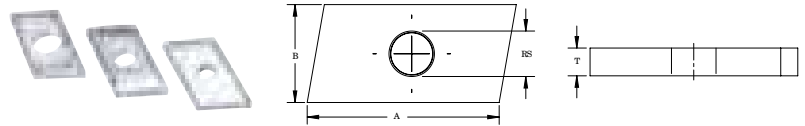

Material: Steel
Finish: Electrogalvanized

Part Number	Article Number	Channel Type	Rod Size	Thickness	A	B
E01CNM6	315370	E0, E0L, E1	M6	4 mm	23 mm	14 mm
E01CNM8	315340	E0, E0L, E1	M8	4 mm	23 mm	14 mm
E01CNM10	315350	E0, E0L, E1	M10	4 mm	23 mm	14 mm

ECN NUT FOR C-CHANNEL E2/E2L/E3

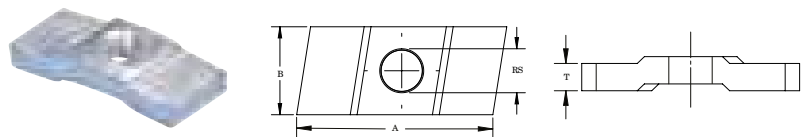

Material: Steel
Finish: Electrogalvanized

Part Number	Article Number	Channel Type	Rod Size	Thickness	A	B
E23CNM10	585270	E2, E2L, E3	M10	5 mm	29 mm	13 mm
E23CNM6	585250	E2, E2L, E3	M6	5 mm	29 mm	13 mm
E23CNM8	585260	E2, E2L, E3	M8	5 mm	29 mm	13 mm

ECN NUT FOR C-CHANNEL E4

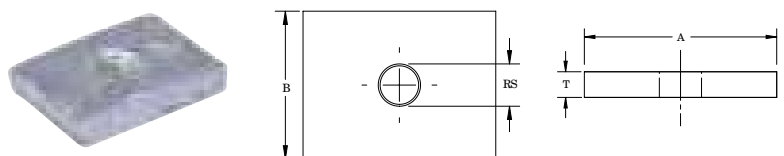

Material: Steel
Finish: Electrogalvanized

Part Number	Article Number	Channel Type	Rod Size	Thickness	A	B
E4CNM10	315360	E4	M10	6 mm	30 mm	23 mm
E4CNM8	315330	E4	M8	6 mm	30 mm	23 mm

Metal Framing

C-CHANNEL SYSTEM

ECN NUT FOR C-CHANNEL E5

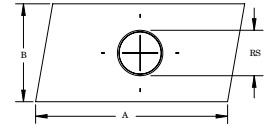
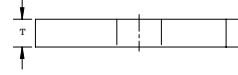

Part Number	Article Number	Rod Size	Thickness	A	B
Material: Stainless Steel 304 (EN 1.4301)					
E5CN6S4	335200	M6	5 mm	22 mm	13 mm
E5CN8S4	335210	M8	5 mm	22 mm	13 mm
Material: Steel – Finish: Hot-Dip Galvanized					
E5CN10HD	335190	M10	6 mm	22 mm	13 mm
E5CN6HD	335170	M6	5 mm	22 mm	13 mm
E5CN8HD	335180	M8	6 mm	22 mm	13 mm

ECN SQUARE NUT FOR C-CHANNEL E5

- Heavy duty

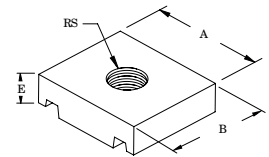

Part Number	Article Number	Rod Size	A	B	E
Material: Stainless Steel 304 (EN 1.4301)					
5190S6	335160	M10	34 mm	29 mm	11 mm
Material: Steel – Finish: Hot-Dip Galvanized					
5190HD	335150	M10	34 mm	29 mm	11 mm

Metal Framing

C-CHANNEL SYSTEM

CANTILEVER ARM WITH EOL CHANNEL

- Perforated, cold rolled
- Slotted backplate

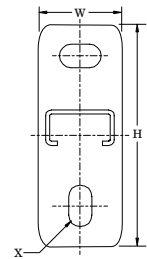
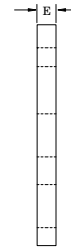
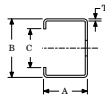
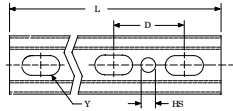
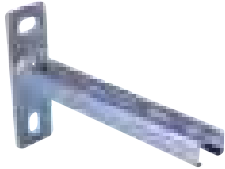

Material: Steel
Finish: Electrogalvanized

Part Number	Article Number	Length	Certifications
CE0L13H0180EG	599879	180 mm	ITB
CE0L13H0300EG	599880	300 mm	ITB

Height	Width	Thickness	A	B	C	D
120 mm	40 mm	1.25 mm	18 mm	27 mm	15.5 mm	60 mm
120 mm	40 mm	1.25 mm	18 mm	27 mm	15.5 mm	60 mm

CANTILEVER ARM WITH E0 CHANNEL

- Perforated, cold rolled
- Slotted backplate

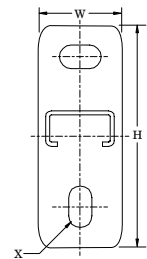
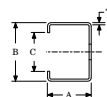
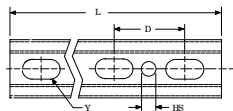

Material: Steel
Finish: Electrogalvanized

Part Number	Article Number	Length	Certifications
CE015H0180EG	599885	180 mm	ITB
CE015H0240EG	599890	240 mm	ITB
CE015H0300EG	599900	300 mm	ITB
CE015H0360EG	599905	360 mm	ITB
CE015H0420EG	599910	420 mm	ITB
CE015H0540EG	599920	540 mm	ITB
CE015H0660EG	599925	660 mm	ITB
CE015H0780EG	599930	780 mm	ITB

Height	Width	Thickness	A	B	C	D
120 mm	40 mm	1.5 mm	30 mm	27 mm	15.5 mm	60 mm

Metal Framing

C-CHANNEL SYSTEM

CANTILEVER ARM WITH E2 CHANNEL

- Perforated, cold rolled
- Slotted backplate

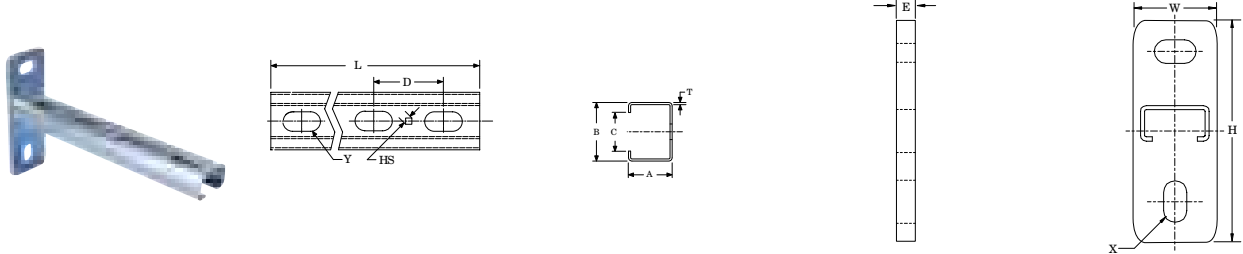

Material: Steel
Finish: Electrogalvanized

Part Number	Article Number	Length	Certifications			
CE224H0200EG	597500	200 mm	ITB			
CE224H0300EG	597510	300 mm	ITB			
Height	Width	Thickness	A	B	C	D
120 mm	40 mm	2.4 mm	20 mm	34 mm	15.5 mm	50 mm
120 mm	40 mm	2.4 mm	20 mm	34 mm	15.5 mm	50 mm

CANTILEVER ARM WITH E3 CHANNEL

- Perforated, cold rolled
- Slotted backplate

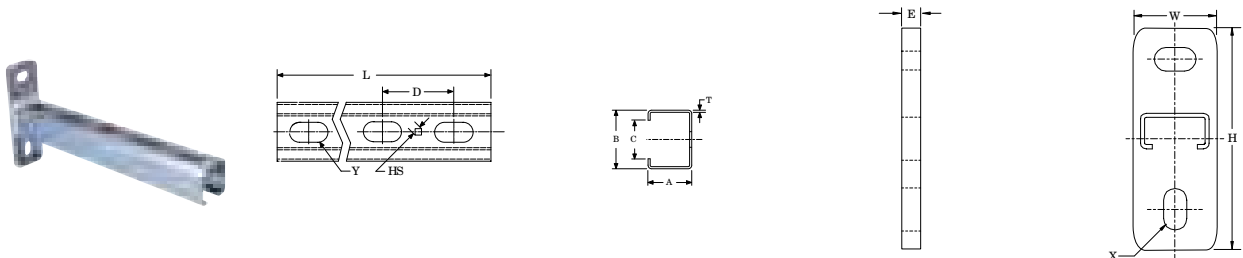

Material: Steel
Finish: Pregalvanized

Part Number	Article Number	Length	Certifications			
CE320H0250EG	585860	250 mm	ITB			
CE320H0500EG	585870	500 mm	ITB			
CE320H0750EG	585880	750 mm	ITB			
Height	Width	Thickness	A	B	C	D
120 mm	40 mm	2 mm	35 mm	35 mm	15.5 mm	50 mm

Metal Framing

C-CHANNEL SYSTEM

CANTILEVER ARM WITH E4 CHANNEL

- Perforated, cold rolled
- Slotted backplate

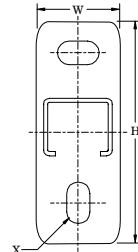
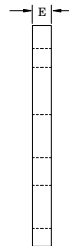
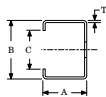
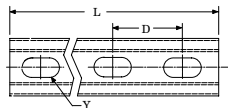

Material: Steel
Finish: Electrogalvanized

Part Number	Article Number	Length	Certifications
CE420H0200EG	599935	200 mm	ITB
CE420H0300EG	599950	300 mm	ITB
CE420H0350EG	599960	350 mm	ITB
CE420H0450EG	599970	450 mm	ITB
CE420H0550EG	599980	550 mm	ITB
CE420H0650EG	599990	650 mm	ITB
CE420H0800EG	599995	800 mm	ITB

Height	Width	Thickness	A	B	C	D
120 mm	40 mm	2 mm	40 mm	38 mm	15.5 mm	50 mm

CANTILEVER ARM WITH E4 CHANNEL AND BRACE

- Slotted backplates

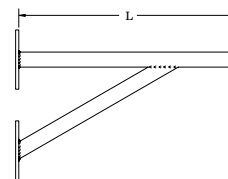
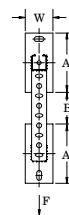
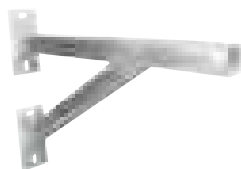

Material: Steel
Finish: Electrogalvanized

Part Number	Article Number	Length	Width	A	B	Ultimate Static Load
CE4SCEG	400047	550 mm	70 mm	150 mm	80 mm	2,400 N

Metal Framing

C-CHANNEL SYSTEM

BRACE ARM FOR E4 CHANNEL

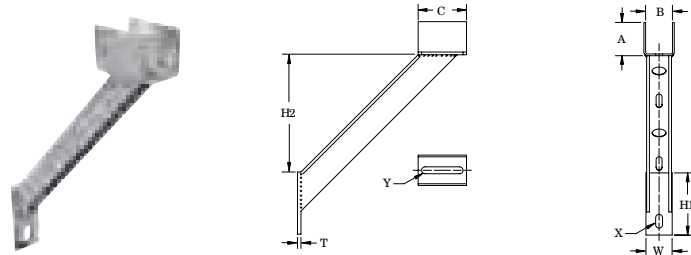

Material: Steel
Finish: Electrogalvanized

Part Number	Article Number	Height 1	Height 2	Width	Thickness	A	B	C	X	Y
CE4SBEG	400046	90 mm	170 mm	38 mm	5 mm	48 mm	39 mm	70 mm	10 x 20 mm	10 x 60 mm

C-CHANNEL U-SHAPED WASHER

- U-shaped wrap around washer
- For use with C-Profiles

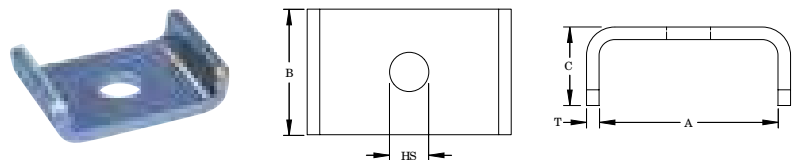

Material: Steel
Finish: Electrogalvanized

Part Number	Article Number	A	B	C	Thickness	Hole Size	Channel Type
PLNE008	588240	28 mm	30 mm	15.0 mm	2 mm	8.5 mm	E0, E0L
PLNE010	588250	28 mm	30 mm	15.0 mm	2 mm	10.5 mm	E0, E0L
PLNE1208	588260	31 mm	30 mm	13.5 mm	2 mm	8.5 mm	E0L, E0, E1
PLUNI10	588290	35 mm	30 mm	10.0 mm	3 mm	10.5 mm	E1, E2, E2L
PLNE3408	588280	39 mm	30 mm	17.5 mm	3 mm	8.5 mm	E2, E3, E4
PLNE3410	588285	39 mm	30 mm	17.5 mm	3 mm	10.5 mm	E2, E3, E4

C-CHANNEL 1-1 SLOT ANGLE BRACKET

- Universally applicable for the construction of assembly systems

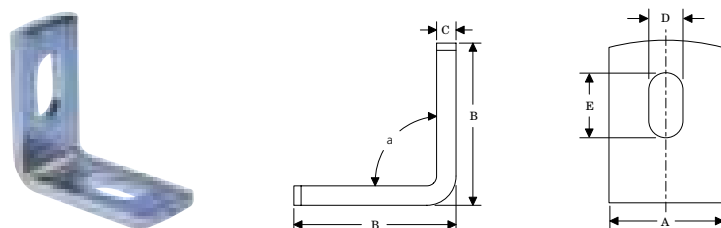

Material: Steel
Finish: Electrogalvanized

Part Number	Article Number	Channel Type	Angle	A	B	C	D	E
EBS25A090	584660	E0, E0L, E1	90°	25 mm	45 mm	5 mm	10.5 mm	20 mm
EBS35A090	587530	E2, E2L, E3, E4	90°	35 mm	50 mm	6 mm	10.5 mm	20 mm

Metal Framing

C-CHANNEL SYSTEM

C-CHANNEL 2-2 SLOT ANGLE BRACKET

- Universally applicable for the construction of assembly systems

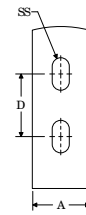
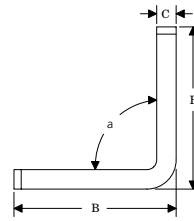

Material: Steel
Finish: Electrogalvanized

Part Number	Article Number	Channel Type	Angle	A	B	C	D	Slot Size
EBL250A90	584666	E0, E0L, E1	90°	25 mm	85 mm	5 mm	30 mm	10.5 mm x 20 mm
EBL35A090	587510	E2, E2L, E3, E4	90°	35 mm	85 mm	6 mm	30 mm	10.5 mm x 20 mm

C-CHANNEL 2-2 SLOT OPEN CORNER ANGLE BRACKET

- Universally applicable for the construction of assembly systems

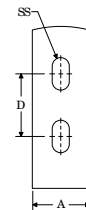
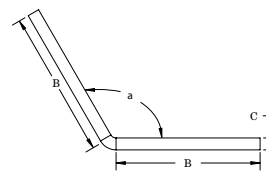

Material: Steel
Finish: Electrogalvanized

Part Number	Article Number	Channel Type	Angle	A	B	C	D	Slot Size
EBL25A135	584668	E0, E0L, E1	135°	25 mm	85 mm	5 mm	30 mm	10.5 mm x 20 mm
EBL35A135	587520	E2, E2L, E3, E4	135°	35 mm	85 mm	6 mm	30 mm	10.5 mm x 20 mm

Metal Framing

C-CHANNEL SYSTEM

C-CHANNEL BEAM CLAMP

- C-Channel system

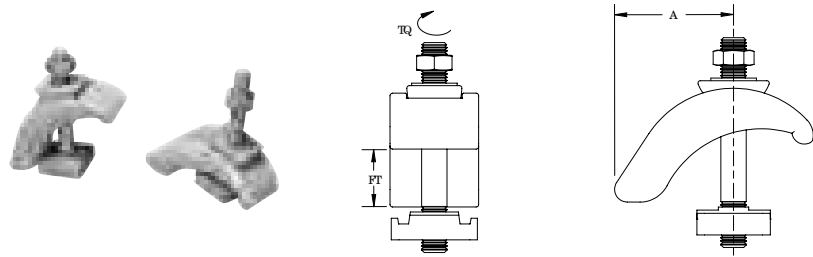

Material: Steel
Finish: Hot-Dip Galvanized

Part Number	Article Number	Channel Type	Flange Thickness	A	Torque
5120HD	335100	E5	3 – 30 mm	50 – 60 mm	30 N-m

C-CHANNEL BEAM CLAMP WITH U-BOLT

- Beam clamp for C-Profiles
- Complete with plate, U-bolt and fixings

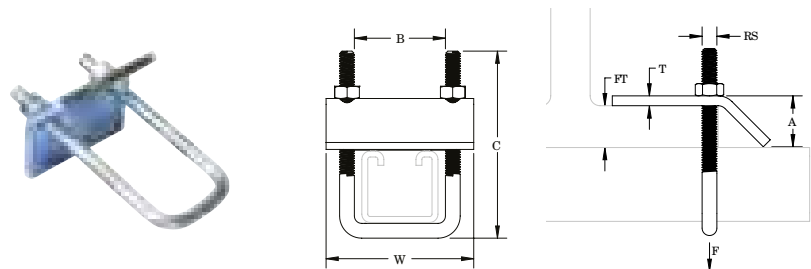

Material: Steel
Finish: Electrogalvanized

Part Number	Article Number	Channel Type	Rod Size	Flange Thickness	Width	Thickness	A	B	C	Static Load
BCE03	585120	E0L, E0, E1, E2L, E2	M6	16 mm Max	60 mm	4 mm	20 mm	36 mm	70 mm	1,250 N
BCE4	585110	E4, E5	M8	16 mm Max	70 mm	6 mm	24 mm	39 mm	100 mm	2,400 N

Static Load is dependent on channel type and length.

C-CHANNEL HORIZONTAL WALL BRACKET

- For use with C-Profiles
- Complete with fixings

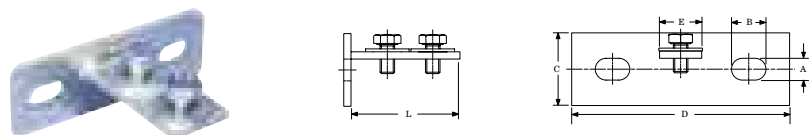

Material: Steel
Finish: Electrogalvanized

Part Number	Article Number	Channel Type	Length	A	B	C	D	E
SHLGE03	584672	E0L, E0, E1, E2, E3	84 mm	11 mm	18 mm	40 mm	120 mm	24 mm
SHLGE4	584673	E4	80 mm	11 mm	19 mm	40 mm	120 mm	30 mm

Metal Framing

C-CHANNEL SYSTEM

C-CHANNEL VERTICAL WALL BRACKET

- For use with C-Profiles
- Complete with fixings

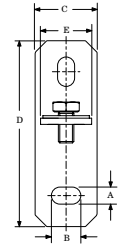
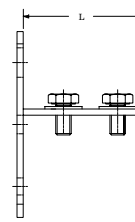

Material: Steel
Finish: Electrogalvanized

Part Number	Article Number	Channel Type	Length	A	B	C	D	E
SHSGE03	584670	E0L, E0, E1, E2, E3	84 mm	11 mm	19 mm	40 mm	120 mm	24 mm
SHSGE4	584671	E4	84 mm	11 mm	18 mm	40 mm	120 mm	30 mm

C-CHANNEL ADJUSTABLE CORNER BRACKET

- Corner bracket for use with C-Profile E4
- To be used with M8 fixings (not included)

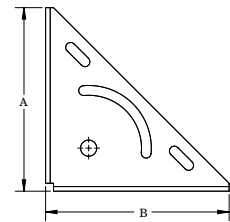
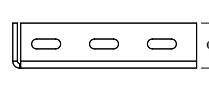

Material: Steel
Finish: Electrogalvanized

Part Number	Article Number	Channel Type	A	B	C
MPE4	400916	E4	160 mm	160 mm	40 mm

C-CHANNEL COUPLER, TYPE E3

- For use with C-Profiles
- Complete with fixings

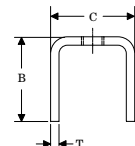
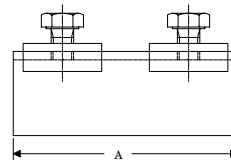

Material: Steel
Finish: Electrogalvanized

Part Number	Article Number	Channel Type	A	B	C	Thickness
RACE3	585780	E3	80 mm	30 mm	30 mm	3 mm

Metal Framing

U-CHANNEL SYSTEM

U-CHANNEL TYPE UC, PERFORATED

- Perforated/slotted design

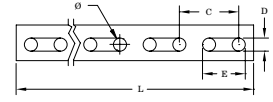
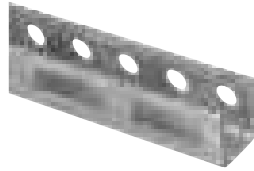

Material: Steel
Finish: Pregalvanized

Part Number	Article Number	Length	A	B	C	D	E	Thickness	Diameter	Certifications
UC202000PG	312200	2,000 mm	30 mm	30 mm	50 mm	11 mm	36 mm	2 mm	11 mm	ITB

2000 U-CHANNEL

- Light duty U-channel for use with 2000 series beam clamps

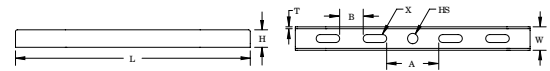

Material: Steel
Finish: Electrogalvanized

Part Number	Article Number	Length	Height	Width	Thickness	Hole Size	X	A	B
2002EG	570310	200 mm	12 mm	25 mm	2 mm	11 mm	8.5 x 25 mm	30.5 mm	25 mm
2006EG	570350	400 mm	12 mm	25 mm	2 mm	11 mm	8.5 x 25 mm	30.5 mm	25 mm

Metal Framing

U-CHANNEL SYSTEM

3000 U-CHANNEL

- Medium duty U-channel for use with 3000 series beam clamps

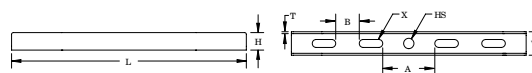

Material: Steel
Finish: Electrogalvanized

Part Number	Article Number	Length	Height	Width	Thickness	Hole Size	X	A	B
3001EG	570560	300 mm	15 mm	30 mm	2.5 mm	13 mm	10.5 x 25 mm	31.5 mm	25 mm
3002EG	570570	400 mm	15 mm	30 mm	2.5 mm	13 mm	10.5 x 25 mm	31.5 mm	25 mm
3003EG	570580	500 mm	15 mm	30 mm	2.5 mm	13 mm	10.5 x 25 mm	31.5 mm	25 mm
3004EG	570590	600 mm	15 mm	30 mm	2.5 mm	13 mm	10.5 x 25 mm	31.5 mm	25 mm

U-CHANNEL CANTILEVER ARM, PERFORATED WITH BRACE

- U-Profile cantilever arm with brace
- Perforated/slotted design

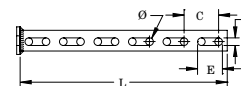
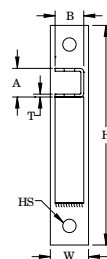

Material: Steel
Finish: Hot-Dip Galvanized

Part Number	Article Number	Length	Height	Width	Hole Size
CUCS0250HD	312110	250 mm	230 mm	40 mm	13 mm
CUCS0300HD	312120	300 mm	230 mm	40 mm	13 mm
CUCS0400HD	312140	400 mm	230 mm	40 mm	13 mm
CUCS0500HD	312160	500 mm	230 mm	40 mm	13 mm
CUCS0600HD	312170	600 mm	230 mm	40 mm	13 mm
CUCS0800HD	312180	800 mm	400 mm	40 mm	13 mm
CUCS1000HD	312190	1,000 mm	400 mm	40 mm	13 mm
CUCS1300HD	312195	1,300 mm	400 mm	40 mm	13 mm

A	B	C	D	E	Thickness	Diameter
30 mm	30 mm	50 mm	11 mm	36 mm	3 mm	11 mm

Metal Framing

U-CHANNEL SYSTEM

2000 U-CHANNEL BEAM CLAMP

- For use with 2000 series U-channels
- Requires installation in pairs

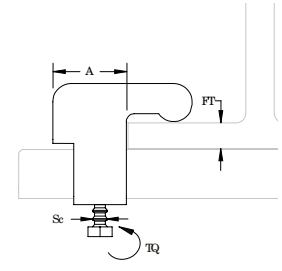

Material: Steel
Finish: Electrogalvanized

Part Number	Article Number	Flange Thickness	A	Screw Diameter	Torque
2025EG	570240	11 mm Max	25 mm	M6	30 N-m

3000 U-CHANNEL BEAM CLAMP

- For use with 3000 series U-channels
- Requires installation in pairs

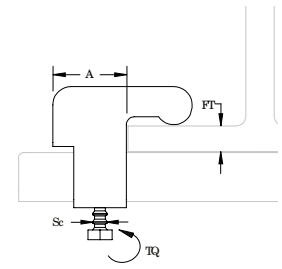

Material: Steel
Finish: Electrogalvanized

Part Number	Article Number	Flange Thickness	A	Screw Diameter	Torque
3025EG	570500	15 mm Max	40 mm	M8	30 N-m

nVent CADDY Rod Lock Telescoping Strut Replacement

See page 6-9 for more information

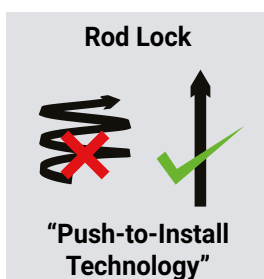

- Easy “push-to-install” design allows installers to simply push the threaded rod through the mounting hole, instantly holding it in position



Metal Framing

TELESCOPING SUPPORT BRACKETS

TELESCOPING STRUT REPLACEMENT, NO NUT

- Can be attached directly to a wall for wall-mounted applications
- Telescopes to the desired length and is locked in place by snapping closed a spring retainer clip
- Standard strut profile runs the entire length of the part, allowing most standard fittings to be placed anywhere between the rods
- Integrated ruler displays space between hanger rods in inches and centimeters
- Supports up to seven 2" (50 DN) conduits, six 2" (50 DN) water filled pipes at 10' (3 m) spacing, or up to 18" (450 mm) cable tray
- Conduit can be supported on the top and bottom, eliminating the need for double sided strut
- Conduit and pipe can be placed directly on the strut profile, saving vertical space in buildings with limited room for installation

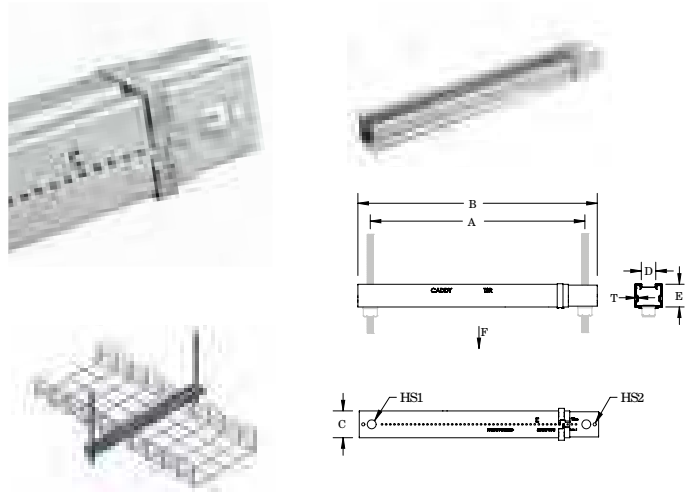

Material: Steel
Finish: Pregalvanized

Part Number	Article Number	Hole Size 1	Hole Size 2	Thickness	A	B	C	D	E	Static Load 1
TSR1220N	366593	13.7 mm	4.8 mm	1 mm	318 - 508 mm	356 - 546 mm	41 mm	22.2 mm	35 mm	1,330 N

Static Load 1 represents a distributed load for 12" - 20" (300 - 500 mm) installations and a point load for 12" - 16" (300 - 400 mm) installations. Static Load 2 represents a point load for 16" - 20" (400 - 500 mm) installations.

TELESCOPING STRUT REPLACEMENT, RETROFIT

- Slotted ends allow the bracket to be installed with four nVent CADDY SN Nuts on threaded rod above an existing trapeze, saving contractor time and limiting building downtime
- Telescopes to the desired length and is locked in place by snapping closed a spring retainer clip
- Standard strut profile runs the entire length of the part, allowing most standard fittings to be placed anywhere between the rods
- Integrated ruler displays space between hanger rods in inches and centimeters
- Supports up to seven 2" (50 DN) conduits, six 2" (50 DN) water filled pipes at 10' (3 m) spacing, or up to 18" (450 mm) cable tray
- Conduit can be supported on the top and bottom, eliminating the need for double sided strut
- Conduit and pipe can be placed directly on the strut profile, saving vertical space in buildings with limited room for installation

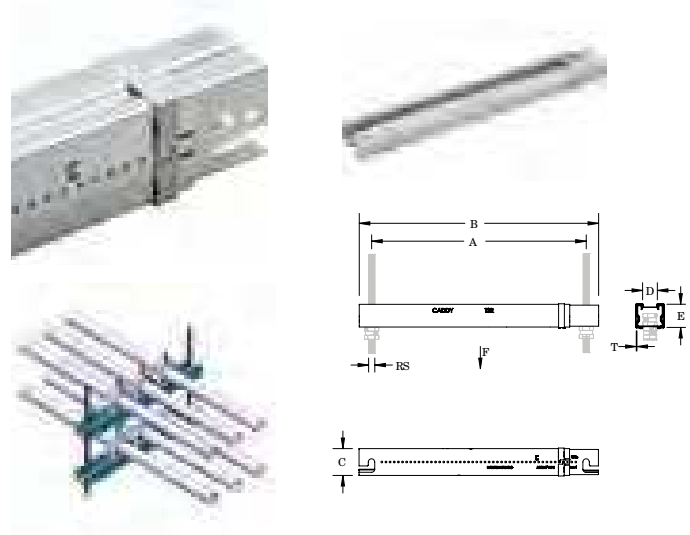

Material: Steel
Finish: Pregalvanized

Part Number	Article Number	Rod Size	Thickness	A	B	C	D	E	Static Load 1	Static Load 2
TSR1220R	366594	M10	1 mm	318 - 508 mm	356 - 546 mm	41 mm	22.2 mm	35 mm	1,330 N	880 N

Static Load 1 represents a distributed load for 12" - 20" (300 - 500 mm) installations and a point load for 12" - 16" (300 - 400 mm) installations. Static Load 2 represents a point load for 16" - 20" (400 - 500 mm) installations.

Metal Framing

SUPPORT KITS

UNIVERSAL SUPPORT KIT

- Kit of two strut cantilever brackets, two channels and all fixings (excluding fixings to structure)

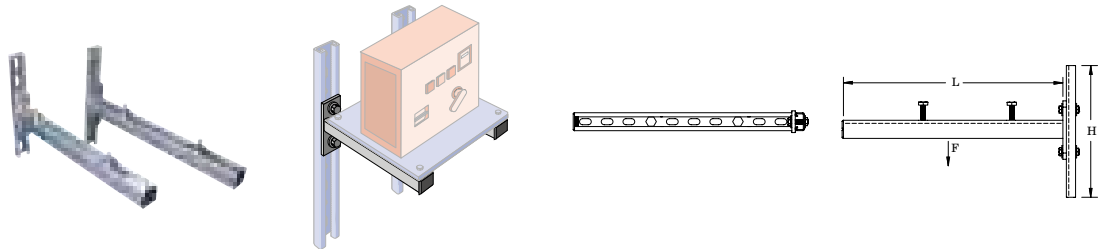

Material: Steel
Finish: Hot-Dip Galvanized

Part Number	Article Number	Length	Height	Static Load
KIT600	590010	600 mm	300 mm	730 N

UNIVERSAL SUPPORT KIT WITH SOUND INSULATORS

- Kit of two strut cantilever brackets, two channels and all fixings (excluding fixings to structure)
- Includes sound absorbers (suitable for compression only)

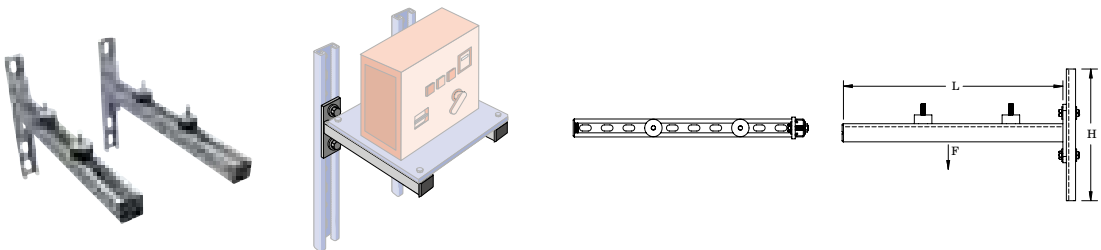

Material: Steel
Finish: Hot-Dip Galvanized

Part Number	Article Number	Length	Height	Static Load
KIT600ISO	589990	600 mm	300 mm	730 N

Metal Framing

SOUND INSULATION

RUBBER PROFILE FOR STRUT CHANNEL

- EPDM insulation profile to prevent contact between support and ventilation duct
- Suitable for strut
- Can be used with threaded rods up to M10

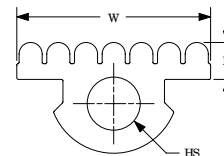

Material: EPDM-SBR Rubber
Temperature: -50 to 110 °C

Part Number	Article Number	Length	Height	Width	Hole Size
ISOSTRUT	335980	20 m	8 mm	42 mm	11 mm

RUBBER PROFILE FOR C-CHANNEL

- EPDM insulation profile to prevent contact between support and ventilation duct
- For use with C-Profiles
- Can be used with threaded rods up to M10

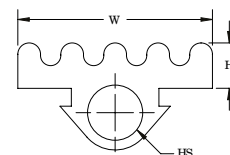

Material: EPDM-SBR Rubber
Temperature: -50 to 110 °C

Part Number	Article Number	Channel Type	Length	Height	Width	Hole Size
ISOE01	400914	E0, E0L, E1, E2, E2L	30 m	6 mm	31 mm	8.5 mm

Metal Framing

WALL BRACKETS

APX EXTERNAL VERTICAL WALL BRACKET

- Saddle support for C-Profiles and strut
- Complete with fixings

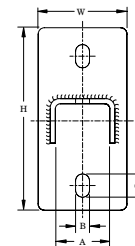
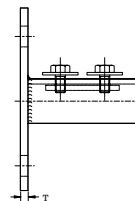

Part Number	Article Number	Channel Type	Strut Type	Height	Width	Thickness	A	B	C
Material: Stainless Steel 316 (EN 1.4401)									
APXSTRUTS6	584820		A (41 x 41 mm), C (21 x 41 mm)	144 mm	70 mm	6 mm	43 mm	12 mm	19 mm
Material: Steel – Finish: Electrogalvanized									
APXE01EG	584715	E0L, E0, E1		114 mm	50 mm	5 mm	31 mm	12 mm	19 mm
APXE23EG	584710	E2L, E2, E3		114 mm	50 mm	5 mm	36 mm	12 mm	19 mm
APXE4STRUTEG	584725	E4	A (41 x 41 mm), C (21 x 41 mm)	144 mm	70 mm	5 mm	43 mm	12 mm	19 mm

APY EXTERNAL HORIZONTAL WALL BRACKET

- Side mount saddle support for C-Profiles and strut
- Complete with fixings

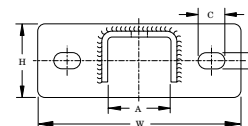
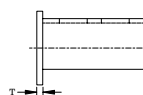

Part Number	Article Number	Channel Type	Strut Type	Height	Width	Thickness	A	B	C
Material: Stainless Steel 316 (EN 1.4401)									
APYSTRUTS6	584840		A (41 x 41 mm), C (21 x 41 mm)	50 mm	144 mm	5 mm	43 mm	12 mm	19 mm
Material: Steel – Finish: Electrogalvanized									
APYE01EG	584758	E0L, E0, E1		40 mm	124 mm	5 mm	31 mm	12 mm	19 mm
APYE23EG	584740	E2L, E2, E3		40 mm	124 mm	5 mm	36 mm	12 mm	19 mm
APYE4STRUTEG	584751	E4	A (41 x 41 mm), C (21 x 41 mm)	50 mm	144 mm	5 mm	43 mm	12 mm	19 mm

Technical Information



Technical Information

Static load limit values specify maximum allowable installed loads for user application.

Load ratings are only valid within +5 to + 35°C unless otherwise specified in this catalogue.

All loads should be applied VERTICALLY to the normal fixing product installation except as may be indicated otherwise in diagrams. If no direction is indicated or a zero load rating is given, the product is to be used for positioning purposes only.

A load rating in this catalogue is only applicable if the load-bearing capacity of the supporting element (purlin, angle beam, flange, bar, etc.) is adequate.

Any repositioning, deformation, or cracking of the supporting element should be a warning that the load bearing capacity of the element is exceeded. In such situations, take preventive measures: consult a structural engineer, or consult nVent for advice.

A standard 4:1 Safety Factor is used unless otherwise noted.

NOTE: 1kg = 10N

MATERIALS – PLASTICS AND RUBBERS

Plastics versus thermosets

- Thermoplastics will melt and flow when heated.
- Thermosets have undergone an irreversible chemical reaction and additional heat will not melt them further.

Polyethylene (PE)

Polyethylene is a tough, light, flexible synthetic resin and is the most common thermoplastic. Many different grades exist with a broad range of physical properties.

Polypropylene (PP)

Polypropylene is a thermoplastic that is light, rugged and resistant to many chemical solvents, bases and acids. It is typically tough and flexible.

Polyvinyl Chloride (PVC)

Polyvinyl chloride (abbreviated PVC), is a thermoplastic made from a tough, chemically resistant synthetic resin. Unplasticized PVC is stiff and strong, but can be made softer and more flexible by the addition of plasticizers.

EPDM Rubber

EPDM (Ethylene Propylene Diene Monomer) is a thermoset elastomer that is inherently resistant to ozone, water and weather, and characterized by a wide range of applications.

SBR Rubber

SBR (Styrene Butadiene Rubber) is the most common type of synthetic rubber. This thermoset has good abrasion resistance, flexibility, and aging stability when protected by additives.

Nylon

Nylon is part of a family of thermoplastics known generically as polyamides. It is generally characterized by its durability, high elongation and excellent abrasion resistance.

Polyamide

See nylon

Xenoy

Xenoy is a thermoplastic blend that offers good chemical resistance, great impact resistance (even at low temperatures), and some heat resistance in conditions that require a high degree of toughness.

Polyisocyanurate (PIR)

Polyisocyanurate (also called PIR, polyiso, or ISO) is a cellular, thermoset that is typically produced as a foam and used in rigid thermal insulation. As a result of its excellent thermal insulating efficiency, polyiso foam has become the standard for low temperature insulation applications.

Silicone Rubber

Silicone rubber is an elastomer (rubber-like material) composed of silicone—itsself a polymer—containing silicon together with carbon, hydrogen, and oxygen.

Silicone rubber is generally non-reactive, stable, and resistant to extreme environments and temperatures from <-40 °C to >220 °C while still maintaining its useful properties

Technical Information

MATERIALS – METALS

Steel

Steel is an alloy of iron and other elements, the most common being carbon. Varying the amount of alloying elements and the form of their presence in the steel controls qualities such as the hardness, ductility, tensile strength and corrosion resistance of the resulting steel.

Spring Steel

Spring steel is an alloy of iron and carbon. Spring steel alloys can be easily formed into complex shapes, and then heat-treated to greatly increase strength.

nVent CADDY spring steel fasteners are heat treated in modern shaker hearth furnaces. Parts are conveyed directly from a high temperature furnace to a quench tank, through a cleaning cycle and into a tempering furnace. Precision controls maintain heat treat operations within established limits developed for nVent CADDY fasteners.

Stainless Spring Steel 301, EN 1.4310

A highly ductile steel used on formed products that hardens rapidly during mechanical working. Stainless 301 has better wear resistance and fatigue strength than Stainless 304 or standard Spring Steel.

- Stainless 301 is not suitable for use in swimming pools

Stainless Steel

Stainless Steel is an alloy of iron and carbon that is more resistant to rust, staining and corrosion than regular steel.

Stainless Steel 304, EN 1.4301

The most familiar stainless steel is Type 304, containing 18-20% chromium and 8-10% nickel.

- Also referred to as 'A2'
- Stainless 304 is not suitable for use in swimming pools

Stainless Steel 316, EN 1.4401

The second most common stainless steel is 316, also called marine grade stainless, used primarily for its increased resistance to corrosion.

- Also referred to as 'A4'
- Stainless 316 is not suitable for use in swimming pools

Cast Iron

Cast Iron is a commercial alloy of iron, carbon and silicon that is cast in a mold. This results in a product that is hard, brittle, non-malleable and incapable of being hammer-welded but more easily fusible than steel.

***Note:** Spring steel fasteners are for indoor use in non-corrosive environments. Mild steel fasteners can be used outdoors in humid or mildly corrosive environments. Neither Stainless Steel nor Mild Steel fasteners are to be used in certain areas such as over indoor pools, etc.

FINISHES

Painted

Paint is any liquid composition, which after application to a surface in a thin layer, is converted to a solid film. It is most commonly used to protect, color or provide texture to objects.

nVent CADDY Armour

The Armour coating system features bi-metallic corrosion protection with an inorganic basecoat for sacrificial protection and an organic topcoat for barrier protection.

The nVent standard for Armour includes at least 1,000 hours resistance against red rust when tested per the ASTM B117 / EN ISO 9227 salt spray tests. Armour is RoHS compliant.

Electro-galvanized (EG)

DIN EN ISO 2081:2009-05 / ASTM B633

This corrosion protective coating is applied after the fabrication of steel or malleable iron parts and uses an electrolytic plating process that deposits zinc. A second passivation coating of chromate is then applied for additional protection. Zinc electroplate products are recommended for indoor and mildly corrosive applications.

Pre-galvanized Zinc (PG)

EN 10142/10147 / ASTM A653/A653M

Pre-galvanized zinc is produced by continuously rolling steel coils or sheets through molten zinc at the mills. The coils or sheets are slit to size and fabricated by forming, shearing or punching to produce the finished product. During fabrication cut edges are not generally zinc coated; however, the zinc near the uncoated metal becomes a sacrificial anode to protect the bare areas. Pre-galvanized zinc products are generally recommended for indoor use on mildly corrosive environments.

Hot Dip Galvanized Zinc (HD)

EN ISO 1461 / ASTM A123

After a product has finished its fabrication process, it is dipped into a bath of molten zinc. The zinc completely coats all edges and surfaces. Zinc thickness is controlled by the time the part is immersed in the molten zinc bath. Hot dip galvanized zinc products are recommended for indoor, outdoor and mildly corrosive environments.

Black Oxide

ASTM D769

Black oxide or blackening is a conversion coating for ferrous materials, copper and copper based alloys, zinc, powdered metals, and silver solder. It is used to add mild corrosion resistance and for appearance.

Red Oxide

Red oxide is a base coating for ferrous materials. It is used in preparation for a topcoat and also adds mild corrosion resistance.

Technical Information

SEAMLESS PIPE FOR THREADING

EN 10225M (REPLACES DIN 2440)

ø Pipe D (DN, NB)	ø Pipe D (")	ø Pipe D OD (mm)	Wall Thickness (mm)	Weight of Pipe (kg/m)	Weight of Water (full Pipe) (kg/m)	Weight of Pipe & Water (kg/m)	Span Max. (m)
8	1/4"	13.5	2.35	0.65	0.06	0.71	1.5
10	3/8"	17.2	2.35	0.86	0.12	0.98	2.25
15	1/2"	21.3	2.65	1.22	0.20	1.42	2.75
20	3/4"	26.9	2.65	1.58	0.37	1.95	3
25	1"	33.7	3.25	2.44	0.58	3.02	3.5
32	1-1/4"	42.4	3.25	3.14	1.01	4.15	3.75
40	1-1/2"	48.3	3.25	3.61	1.37	4.98	4.25
50	2"	60.3	3.65	5.10	2.21	7.31	4.75
65	2-1/2"	76.1	3.65	6.52	3.72	10.24	5.5
80	3"	88.9	4.05	8.47	5.13	13.60	6
100	4"	114.3	4.5	12.19	8.70	20.89	6
125	5"	139.7	4.85	16.13	13.27	29.40	6
150	6"	165.1	4.85	19.17	18.96	38.13	6

Note: The Maximum hanger span depends on the specific pipe-type and manufacturer.

Technical Information

SEAMLESS STEEL PIPES

EN 10220 (REPLACES DIN 2448)

ø Pipe D (DN, NB)	ø Pipe D (")	ø Pipe D OD (mm)	Wall Thickness (mm)	Weight of Pipe (kg/m)	Weight of Water (full Pipe) (kg/m)	Weight of Pipe & Water(kg/m)	Span Max. (m)
6		10.2	1.6	0.34	0.04	0.38	1.25
8	1/4"	13.5	1.8	0.52	0.08	0.60	1.5
-		16	1.8	0.63	0.12	0.75	2
10	3/8"	17.2	1.8	0.68	0.15	0.83	2.25
-		20	2	0.89	0.20	1.09	2.5
15	1/2"	21.3	2	0.95	0.24	1.19	2.75
-		25	2	1.13	0.35	1.48	3
20	3/4"	26.9	2.3	1.40	0.39	1.79	3
-		30	2.6	1.76	0.48	2.24	3.25
-		31.8	2.6	1.87	0.56	2.43	3.25
25	1"	33.7	2.6	1.99	0.64	2.63	3.5
-		38	2.6	2.27	0.85	3.12	3.75
32	1-1/4"	42.4	2.6	2.55	1.09	3.64	3.75
-		44.5	2.6	2.69	1.21	3.90	4
40	1-1/2"	48.3	2.6	2.95	1.46	4.41	4.25
-		51	2.6	3.10	1.65	4.75	4.5
-		57	2.9	3.87	2.06	5.93	4.6
50	2"	60.3	2.9	4.11	2.33	6.44	4.75
-		63.5	2.9	4.33	2.61	6.94	4.75
-		70	2.9	4.80	3.24	8.04	5.25
65	2-1/2"	76.1	2.9	5.24	3.88	9.12	5.5
-		82.5	3.2	6.26	4.55	10.81	5.75
80	3"	88.9	3.2	6.76	5.34	12.10	6
-		101.6	3.6	8.70	7.00	15.70	6
-		108	3.6	9.27	7.98	17.25	6
100	4"	114.3	3.6	9.83	9.00	18.83	6
-		127	4	12.13	11.12	23.25	6
-		133	4	12.73	12.27	25.00	6
125	5"	139.7	4	13.39	13.62	27.01	6
-		152.4	4.5	16.41	16.14	32.55	6
-		159	4.5	17.15	17.66	34.81	6
150	6"	168.3	4.5	18.18	19.92	38.10	6
-		177.8	5	21.31	22.10	43.41	6
-		193.7	5.4	25.08	26.26	51.34	6
200	8"	219.1	5.9	31.02	33.73	64.75	6
-		244.5	6.3	37.01	42.22	79.23	6
250	10"	273	6.3	41.44	53.26	94.70	6
300	12"	323.9	7.1	55.47	75.33	130.80	6
350	14"	355.6	8	68.58	90.58	159.16	6
400	16"	406.4	8.8	86.29	118.73	205.02	6
450	18"	457	10	110.24	149.99	260.23	6
500	20"	508	11	134.82	185.51	320.33	6
600	24"	610	12.5	184.19	268.78	452.97	6

Note: The Maximum hanger span depends on the specific pipe-type and manufacturer.

Technical Information

WELDED STEEL PIPE

EN 10220 (REPLACES DIN 2458)

ø Pipe D (DN, NB)	ø Pipe D (")	ø Pipe D OD (mm)	Wall Thickness (mm)	Weight of Pipe (kg/m)	Weight of Water (full Pipe) (kg/m)	Weight of Pipe & Water (kg/m)	Span Max. (m)
6		10.2	1.6	0.34	0.04	0.38	1.25
8	1/4"	13.5	1.8	0.52	0.08	0.6	1.5
-		16	1.8	0.63	0.12	0.75	2
10	3/8"	17.2	1.8	0.68	0.15	0.83	2.25
-		20	2	0.89	0.2	1.09	2.5
15	1/2"	21.3	2	0.95	0.24	1.19	2.75
-		25	2	1.13	0.35	1.48	3
20	3/4"	26.9	2	1.23	0.41	1.64	3
-		30	2	1.38	0.53	1.91	3.25
-		31.8	2	1.47	0.61	2.08	3.25
25	1"	33.7	2	1.56	0.69	2.25	3.5
-		38	2.3	2.02	0.88	2.9	3.75
32	1-1/4"	42.4	2.3	2.27	1.12	3.39	3.75
-		44.5	2.3	2.39	1.25	3.64	4
40	1-1/2"	48.3	2.3	2.61	1.5	4.11	4.25
-		51	2.3	2.76	1.69	4.45	4.5
-		57	2.3	3.1	2.16	5.26	4.6
50	2"	60.3	2.3	3.29	2.44	5.73	4.75
-		63.5	2.6	3.9	2.67	6.57	4.75
-		70	2.6	4.32	3.3	7.62	5.25
65	2-1/2"	76.1	2.6	4.71	3.95	8.66	5.5
-		82.5	2.6	5.12	4.69	9.81	5.75
80	3"	88.9	2.9	6.15	5.42	11.57	6
-		101.6	2.9	7.06	7.21	14.27	6
-		108	2.9	7.52	8.2	15.72	6
100	4"	114.3	3.2	8.77	9.14	17.91	6
-		127	3.2	9.77	11.42	21.19	6
-		133	3.6	11.49	12.43	23.92	6
125	5"	139.7	3.6	12.08	13.79	25.87	6
-		152.4	4	14.64	16.38	31.02	6
-		159	4	15.29	17.91	33.2	6
150	6"	168.3	4	16.21	20.18	36.39	6
-		177.8	4.5	19.23	22.38	41.61	6
-		193.7	4.5	21	26.79	47.79	6
200	8"	219.1	4.5	23.82	34.67	58.49	6
-		244.5	5	29.53	43.19	72.72	6
250	10"	273	5	33.05	54.33	87.38	6
300	12"	323.9	5.6	43.96	76.8	120.76	6
350	14"	355.6	5.6	48.34	93.16	141.5	6
400	16"	406.4	6.3	62.16	121.8	183.96	6
450	18"	457	6.3	70.02	155.11	225.13	6
500	20"	508	6.3	77.95	192.75	270.7	6
600	24"	610	6.3	93.8	280.3	374.1	6

Note: The Maximum hanger span depends on the specific pipe-type and manufacturer.

Technical Information

DRAINAGE PIPES, GA, CAST IRON

DIN 19500

ø Pipe D (DN, NB)	ø Pipe D OD (mm)	Wall Thickness (mm)	Weight of Pipe (kg/m)	Weight of Water (full Pipe) (kg/m)	Weight of Pipe & Water (kg/m)	Span Max. (m)
50	60	3.5	5.20	2.21	7.41	1.5
70	80	3.5	7.00	4.18	11.18	1.5
100	112	4	11.30	8.49	19.79	1.5
125	137	4	14.00	13.06	27.06	1.5
150	162	5	20.60	18.14	38.74	1.5
200	212	6	32.40	31.40	63.80	1.5

Note: The Maximum hanger span depends on the specific pipe-type and manufacturer. Every pipe should be supported twice at least.

SML DRAINAGE PIPES

DIN 19522

ø Pipe D (DN, NB)	ø Pipe D OD (mm)	Wall Thickness (mm)	Weight of Pipe (kg/m)	Weight of Water (full Pipe) (kg/m)	Weight of Pipe & Water (kg/m)	Span Max. (m)
40	48	3	3.07	1.39	4.46	1.5
50	58	3.5	4.34	2.04	6.38	1.5
70	78	3.5	5.94	3.96	9.9	1.5
80	83	3.5	6.34	4.54	10.88	1.5
100	110	3.5	8.49	8.33	16.82	1.5
125	135	4	11.93	12.67	24.6	1.5
150	160	4	14.21	18.15	32.36	1.5
200	210	5	23.35	31.42	54.77	1.5
250	274	5.5	33.64	54.33	87.97	1.5
300	326	6	43.73	77.44	121.17	1.5
400	429	8.1	77.65	133.83	211.48	1.5
500	532	9	107.21	207.5	314.71	1.5
600	635	9.9	140.95	297.25	438.2	1.5

Note: The Maximum hanger span depends on the specific pipe-type and manufacturer. Every pipe should be supported twice at least.

Technical Information

PVC DRAINAGE PIPES

DIN 8062 - SERIES 3

ø Pipe D (DN, NB)	ø Pipe D OD (mm)	Wall Thickness (mm)	Weight of Pipe (kg/m)	Weight of Water (full Pipe) (kg/m)	Weight of Pipe & Water (kg/m)	Span Max. (40 °C) (m)
32	40	1.8	0.33	1.00	1.33	0.9
40	50	1.8	0.40	1.69	2.09	1.1
50	63	1.9	0.53	2.75	3.29	1.2
70	75	2.2	0.73	3.91	4.65	1.35
80	90	2.7	1.08	5.62	6.70	1.5
100	110	3.2	1.57	8.43	10.00	1.7
125	125	3.7	2.06	10.86	12.92	1.95
150	160	4.7	3.35	17.81	21.16	2.1
-	180	5.3	4.25	22.54	26.78	2.2
-	200	5.9	5.25	27.82	33.07	2.2
-	225	6.6	6.61	35.23	41.84	2.3
-	250	7.3	8.13	43.52	51.65	2.5
-	280	8.2	10.22	54.57	64.80	2.8
-	315	9.2	12.91	69.09	82.00	3

Note: The Maximum hanger span depends on the specific pipe-type and manufacturer.

PVC DRAINAGE PIPES

DIN 8062 - SERIES 5

ø Pipe D (DN, NB)	ø Pipe D OD (mm)	Wall Thickness (mm)	Weight of Pipe (kg/m)	Weight of Water (full Pipe) (kg/m)	Weight of Pipe & Water (kg/m)	Span Max. (40 °C) (m)
10	16	1.2	0.08	0.15	0.23	0.5
15	20	1.5	0.13	0.23	0.35	0.6
20	25	1.9	0.20	0.35	0.55	0.65
25	32	2.4	0.33	0.58	0.91	0.7
32	40	3	0.51	0.91	1.42	0.9
40	50	3.7	0.79	1.43	2.21	1.1
50	63	4.7	1.26	2.26	3.51	1.2
70	75	5.6	1.78	3.20	4.98	1.35
80	90	6.7	2.56	4.61	7.17	1.5
100	110	8.2	3.83	6.88	10.71	1.7
125	125	10.4	6.18	11.16	17.34	1.95
150	160	11.9	8.08	14.57	22.65	2.1
-	180	13.4	10.24	18.43	28.67	2.2
-	200	14.9	12.65	22.75	35.40	2.2
-	225	16.7	15.96	28.83	44.79	2.3
-	250	18.6	19.74	35.57	55.31	2.5
-	280	20.8	24.73	44.64	69.37	2.8
-	315	23.4	31.30	56.49	87.79	3

Note: The Maximum hanger span depends on the specific pipe-type and manufacturer.

Technical Information

PE DRAINAGE PIPES

DIN 19535

ø Pipe D (DN, NB)	ø Pipe D OD (mm)	Wall Thickness (mm)	Weight of Pipe (kg/m)	Weight of Water (full Pipe) (kg/m)	Weight of Pipe & Water (kg/m)	Span Max. (m)
26	32	3	0.27	0.53	0.80	0.32
34	40	3	0.35	0.91	1.26	0.40
40	50	3	0.44	1.52	1.96	0.50
50	56	3	0.50	1.96	2.46	0.56
60	63	3	0.57	2.55	3.12	0.63
70	75	3	0.68	3.74	4.42	0.75
80	90	3.5	0.95	5.41	6.36	0.90
100	110	4.3	1.43	8.07	9.50	1.10
115	125	4.8	1.82	10.45	12.27	1.25
125	140	5.4	2.30	13.10	15.39	1.40
150	160	6.2	3.00	17.10	20.11	1.60
200	200	6.2	3.83	27.63	31.46	2.00
250	250	7.8	6.02	43.13	49.15	2.50
300	315	9.8	9.40	68.51	77.91	3.15

COPPER TUBE

EN 1057 (REPLACES DIN 1786)

ø Pipe D (DN, NB)	ø Pipe D (Inch)	ø Pipe D OD (mm)	Wall Thickness (mm)	Weight of Pipe (kg/m)	Weight of Water (full Pipe) (kg/m)	Weight of Pipe & Water (kg/m)	Span Max. (m)
		10	1	0.25	0.05	0.30	1.25
10		12	1	0.31	0.08	0.39	1.25
12		15	1	0.39	0.13	0.52	1.25
15		18	1	0.48	0.20	0.68	1.5
20		22	1	0.59	0.31	0.90	2
25		28	1.5	1.11	0.49	1.60	2.25
32		35	1.5	1.41	0.80	2.21	2.75
40		42	1.5	1.70	1.19	2.89	3
50		54	2	2.91	1.96	4.87	3.5
		64	2	3.47	2.83	6.30	4
65		76,1	2	4.17	4.08	8.25	4.25
80		88,9	2	4.89	5.66	10.55	4.75
		108	2.5	7.42	8.33	15.75	5
		133	3	10.98	12.67	23.65	5
		159	3	13.17	18.39	31.56	5
		219	3	18.24	35.63	53.87	5
		267	3	22.29	53.50	75.79	5

Note: The Maximum hanger span depends on the specific pipe-type and manufacturer.

Technical Information

STEEL DUCT - SPIRAL

EN 12237 (REPLACES DIN24147)

ø Pipe D (DN, NB)	ø Pipe D ID (mm)	Wall Thickness (mm)	Weight of Pipe (kg/m)	Span Max. (40 °C) (m)
80	80	0.4	0.8	3
100	100	0.6	1.5	3
125	125	0.6	1.8	3
150	150	0.6	2.2	3
160	160	0.6	2.4	3
200	200	0.6	3.0	3
224	224	0.6	3.3	3
250	250	0.6	3.7	3
300	300	0.8	5.9	3
315	315	0.8	6.2	3
355	355	0.8	7.0	3
400	400	0.8	7.9	3
450	450	0.8	8.9	3
500	500	0.8	9.9	3
560	560	0.8	11.0	3
630	630	1.0	15.5	3
710	710	1.0	17.5	3
800	800	1.0	19.7	3
900	900	1.0	22.2	3
1000	1000	1.2	29.6	3
1120	1120	1.2	33.1	3
1250	1250	1.2	37.0	3

Note: The Maximum hanger span depends on the specific pipe-type and manufacturer.

Technical Information

WHICH CLAMP FITS WHICH PIPE?

STEEL

ø Pipe D	Supply Pipes / Pressure Pipes			Drain Pipes		Superfix 243 M8	Superfix 243 M8/M10	Macrofix Plus M8/M10	Macrofix M8	Macrofix M8/M10	Macrofix, Stainless Steel	
	EN 10225M	EN 10220	EN 10220	DIN 19500	DIN 19522							
[DN, NB]	["]	Seamless Pipe for threading ø Outside D mm	Seamless steel pipes ø Outside D mm	Welded Steel Pipe ø Outside D mm	Drainage Pipes, GA, Cast Iron ø Outside D mm	SML Drainage Pipes ø Outside D mm						
6	-	-	10.2	10.2	-	-	-	-	-	-	-	
8	1/4"	13.5	13.5	13.5	-	-	400055	400063	400078	586201	586001	586301
-	-	-	16.0	16.0	-	-	-	-	-	-	-	-
10	3/8"	17.2	17.2	17.2	-	-	400056	400064	400079	586202	586002	586302
-	-	-	20.0	20.0	-	-	-	-	-	-	-	-
15	1/2"	21.3	21.3	21.3	-	-	400057	400065	400080	586203	586003	586303
-	-	-	25.0	25.0	-	-	-	-	-	-	-	-
20	3/4"	26.9	26.9	26.9	-	-	400058	400066	400081	586204	586004	586304
-	-	-	30.0	30.0	-	-	-	-	-	-	-	-
-	-	-	31.8	31.8	-	-	-	-	-	-	-	-
25	1"	33.7	33.7	33.7	-	-	400059	400067	400082	586205	586005	586305
-	-	-	38.0	38.0	-	-	-	-	-	-	-	-
32	1 1/4"	42.4	42.4	42.4	-	-	400060	400068	400083	586206	586006	586306
-	-	-	44.5	44.5	-	-	400061	400069	-	-	-	-
40	1 1/2"	48.3	48.3	48.3	-	48.0	-	-	400084	586207	586007	586307
-	-	-	51.0	51.0	-	-	400062	400070	400085	586208	586008	586308
-	-	-	57.0	57.0	-	-	589310	589350	-	-	-	-
50	2"	60.3	60.3	60.3	60.0	58.0	589320	400071	400086	586209	586009	586309
-	-	-	63.5	63.5	-	-	-	400072	400087	-	-	-
-	-	-	70.0	70.0	-	-	-	400073	400088	-	-	-
65	2 1/2"	76.1	76.1	76.1	-	-	-	-	-	-	586010	586310
70	-	-	-	-	80.0	78.0	-	400074	400089	-	-	-
-	-	-	82.5	82.5	-	-	-	-	-	-	586011	586311
80	3"	88.9	88.9	88.9	-	83.0	-	400075	400090	-	586012	586312
-	-	-	101.6	101.6	-	-	-	400076	400091	-	586013	586313
-	-	-	108.0	108.0	-	-	-	400077	-	-	-	-
100	4"	114.3	114.3	114.3	112.0	110.0	-	-	400092	-	586014	586314
-	-	-	127	127	-	-	-	-	400094	-	586015	586315
-	-	-	133	133	-	-	-	-	400095	-	586016	586316
125	5"	139.7	139.7	139.7	137.0	135.0	-	-	400096	-	586017	586317
-	-	-	152.4	152.4	-	-	-	-	-	-	-	-
-	-	-	159	159	162.0	160.0	-	-	400098	-	586018	586318
150	6"	165.1	168.3	168.3	-	-	-	-	400099	-	586019	586319
-	-	-	177.8	177.8	-	-	-	-	-	-	-	-
-	-	-	193.7	193.7	-	-	-	-	400100	-	586020	586320
-	-	-	-	-	212.0	210.0	-	-	400101	-	586021	586321
200	8"	-	219.1	219.1	-	-	-	-	-	-	586022	586322
-	-	-	244.5	244.5	-	-	-	-	-	-	586023	-
250	10"	-	273	273	-	274.0	-	-	-	-	586024	-
300	12"	-	323.9	323.9	-	326.0	-	-	-	-	-	-
350	14"	-	355.6	355.6	-	-	-	-	-	-	-	-
400	16"	-	406.4	406.4	-	429.0	-	-	-	-	-	-
450	18"	-	457	457	-	-	-	-	-	-	-	-
500	20"	-	508	508	-	532.0	-	-	-	-	-	-
600	24"	-	610	610	-	635.0	-	-	-	-	-	-
400	16"	-	406.4	406.4	-	429.0	-	-	-	-	-	-
450	18"	-	457.0	457.0	-	-	-	-	-	-	-	-
500	20"	-	508.0	508.0	-	532.0	-	-	-	-	-	-
600	24"	-	610.0	610.0	-	635.0	-	-	-	-	-	-

Technical Information

WHICH CLAMP FITS WHICH PIPE?

PLASTIC

ø Pipe D		Drain Pipes							
		DIN 8062 - Series 3	DIN 8062 - Series 5	DIN 19535					
[DN, NB]	["]	PVC Drainage Pipes	PVC Drainage Pipes	PE Drainage Pipes	Superfix 243 M8	Superfix 243 M8/M10	Macrofix Plus M8/M10	Macrofix M8	Macrofix M8/M10
		ø Outside D mm	ø Outside D mm	ø Outside D mm					
10	3/8"	-	16	-	400056	400064	400079	586202	586002
15	1/2"	-	20	-	-	-	-	586203	586003
20	3/4"	-	25	-	-	-	-		
25	1"	-	32	32	400059	400067	400082	586205	586005
32	1 1/4"	40	40	40	400060	400068	400083	586206	586006
40	1 1/2"	50	50	50	400062	400070	400085	586207	586007
50	2"	63	63	63	-	400072	400087	586209	586009
70	-	75	75	75	-	400074	400089	-	586010
80	3"	90	90	90	-	400075	400090	-	586012
100	4"	110	110	110	-	400077	400092	-	586014
115	-	-	-	125	-	-	400094	-	586015
125	5"	125	125	140	-	-	400097	-	586017
150	6"	160	160	160	-	-	400098	-	586018
-	-	180	180	-	-	-	-	-	-
-	-	200	200	-	-	-	400100	-	586020
200	8"	-	-	200	-	-		-	
-	-	225	225	-	-	-	-	-	586022
-	-	250	250	250	-	-	-	-	586023

Technical Information

WHICH CLAMP FITS WHICH PIPE?

COPPER

∅ Pipe D		Plumbing Pipe	Superfix 243 M8	Superfix 243 M8/M10	Macrofix Plus M8/M10	Macrofix 250 M8	Macrofix 250 M8/M10
[DN, NB]	["]	EN 1057					
		Copper Tube					
		∅ Outside D mm					
-	-	10	-	-	-	-	-
10	3/8"	12	400055	400063	400078	586201	586001
12	-	15	400056	400064	400079	586202	586002
15	1/2"	18					
20	3/4"	22	400057	400065	400080	586203	586003
25	1"	28	400058	400066	400081	586204	586004
32	1 1/4"	35	400059	400067	400082	586205	586005
40	1 1/2"	42	400060	400068	400083	586206	586006
50	2"	54	589310	589350	400085	586208	586008
-	-	64	-	400072	400087	586209	586009
65	2 1/2"	76.1	-	400074	400089	-	586010
80	3"	88.9	-	400075	400090	-	586012
-	-	108	-	400077	400092	-	586013
-	-	133	-	-	400095	-	586016
-	-	159	-	-	400098	-	586018
-	-	219	-	-	-	-	586022
-	-	267	-	-	-	-	586024

Technical Information

LOADS DATA FOR C-PROFILES

EOL | 18 X 27 MM | T = 1.25 MM

L (mm)	loading case A			loading case B			loading case C		
	F from allowable tension (N)*	F from allowable deflection (N)	allowable load (N)	F from allowable tension (N)*	F from allowable deflection (N)	allowable load (N)	F from allowable tension (N)*	F from allowable deflection (N)	allowable load (N)
250	738	2034	738	1477	3255	1477	554	1194	554
500	369	509	369	738	814	738	277	298	277
750	246	226	226	492	362	362	185	133	133
1000	185	127	127	369	203	203	138	75	75
1250	148	81	81	295	130	130	111	48	48
1500	123	57	57	246	90	90	92	33	33
1750	105	42	42	211	66	66	79	24	24
2000	92	32	32	185	51	51	69	19	19

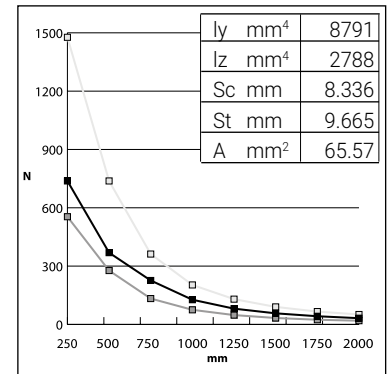

EO | 30 X 27 MM | T = 1.5 MM

L (mm)	loading case A			loading case B			loading case C		
	F from allowable tension (N)*	F from allowable deflection (N)	allowable load (N)	F from allowable tension (N)*	F from allowable deflection (N)	allowable load (N)	F from allowable tension (N)*	F from allowable deflection (N)	allowable load (N)
250	1920	8648	1920	3839	13837	3839	1440	5076	1440
500	960	2162	960	1920	3459	1920	720	1269	720
750	640	961	640	1280	1537	1280	480	564	480
1000	480	540	480	960	865	865	360	317	317
1250	384	346	346	768	553	553	288	203	203
1500	320	240	240	640	384	384	240	141	141
1750	274	176	176	548	282	282	206	104	104
2000	240	135	135	480	216	216	180	79	79

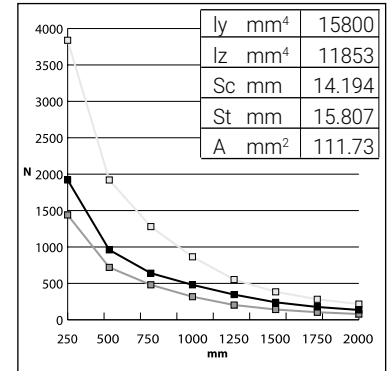

E1 | 15 X 30 MM | T = 2.0 MM

L (mm)	loading case A			loading case B			loading case C		
	F from allowable tension (N)*	F from allowable deflection (N)	allowable load (N)	F from allowable tension (N)*	F from allowable deflection (N)	allowable load (N)	F from allowable tension (N)*	F from allowable deflection (N)	allowable load (N)
250	921	2100	921	1843	3360	1843	691	1232	691
500	461	525	461	921	840	840	346	308	308
750	307	233	233	614	373	373	230	137	137
1000	230	131	131	461	210	210	173	77	77
1250	184	84	84	369	134	134	138	49	49
1500	154	58	58	307	93	93	115	34	34
1750	132	43	43	263	69	69	99	25	25
2000	115	33	33	230	52	52	86	19	19

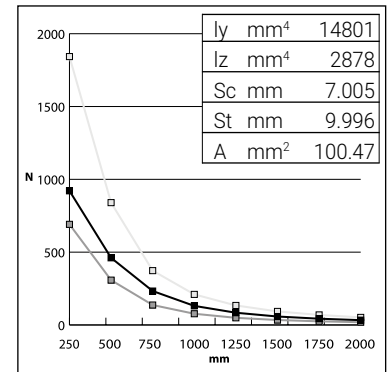

E2L | 20 X 24 MM | T = 1.5 MM

L (mm)	loading case A			loading case B			loading case C		
	F from allowable tension (N)*	F from allowable deflection (N)	allowable load (N)	F from allowable tension (N)*	F from allowable deflection (N)	allowable load (N)	F from allowable tension (N)*	F from allowable deflection (N)	allowable load (N)
250	1425	4267	1425	2850	6828	2850	1069	2505	1069
500	712	1067	712	1425	1707	1425	534	626	534
750	475	474	474	950	759	759	356	278	278
1000	356	267	267	712	427	427	267	157	157
1250	285	171	171	570	273	273	214	100	100
1500	237	119	119	475	190	190	178	70	70
1750	204	87	87	407	139	139	153	51	51
2000	178	67	67	356	107	107	134	39	39

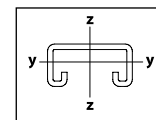
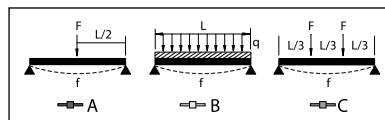
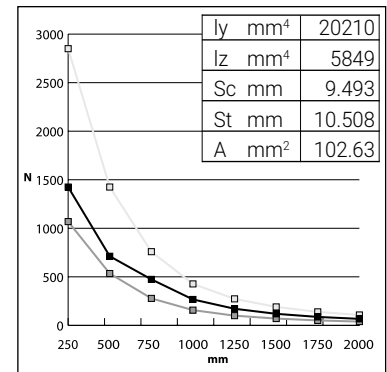

$W_{zul} = 160 \text{ N/mm}$
 $f_{zul} = l/200$

* All load ratings in NEWTON (N). The Load based on allowable tension is based on the material yield, an additional Safety Factor of 2 is recommended.

Technical Information

E3 | 35 X 35 MM | T = 2.0 MM

L (mm)	loading case A			loading case B			loading case C		
	F from allowable tension (N)*	F from allowable deflection (N)	allowable load (N)	F from allowable tension (N)*	F from allowable deflection (N)	allowable load (N)	F from allowable tension (N)*	F from allowable deflection (N)	allowable load (N)
250	4305	22260	4305	8610	35616	8610	3229	13066	3229
500	2152	5565	2152	4305	8904	4305	1614	3266	1614
750	1435	2473	1435	2870	3957	2870	1076	1452	1076
1000	1076	1391	1076	2152	2226	2152	807	817	807
1250	861	890	861	1722	1425	1425	646	523	523
1500	717	618	618	1435	989	989	538	363	363
1750	615	454	454	1230	727	727	461	267	267
2000	538	348	348	1076	557	557	404	204	204
2250	478	275	275	957	440	440	359	161	161
2500	430	223	223	861	356	356	323	131	131
2750	391	184	184	783	294	294	294	108	108
3000	359	155	155	717	247	247	269	91	91

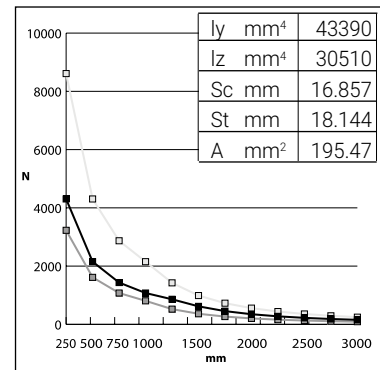

E4 | 40 X 38 MM | T = 2.0 MM

L (mm)	loading case A			loading case B			loading case C		
	F from allowable tension (N)*	F from allowable deflection (N)	allowable load (N)	F from allowable tension (N)*	F from allowable deflection (N)	allowable load (N)	F from allowable tension (N)*	F from allowable deflection (N)	allowable load (N)
250	5697	32752	5697	11395	52403	11395	4273	19224	4273
500	2849	8188	2849	5697	13101	5697	2137	4806	2137
750	1899	3639	1899	3798	5823	3798	1424	2136	1424
1000	1424	2047	1424	2849	3275	2849	1068	1201	1068
1250	1139	1310	1139	2279	2096	2096	855	769	769
1500	950	910	910	1899	1456	1456	712	534	534
1750	814	668	668	1628	1069	1069	610	392	392
2000	712	512	512	1424	819	819	534	300	300
2250	633	404	404	1266	647	647	475	237	237
2500	570	328	328	1139	524	524	427	192	192
2750	518	271	271	1036	433	433	388	159	159
3000	475	227	227	950	364	364	356	133	133

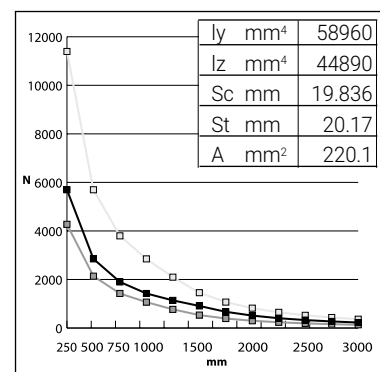

E5 | 20 X 36 MM | T = 3.0 MM

L (mm)	loading case A			loading case B			loading case C		
	F from allowable tension (N)*	F from allowable deflection (N)	allowable load (N)	F from allowable tension (N)*	F from allowable deflection (N)	allowable load (N)	F from allowable tension (N)*	F from allowable deflection (N)	allowable load (N)
250	2417	6890	2417	4835	11023	4835	1813	4044	1813
500	1209	1722	1209	2417	2756	2417	907	1011	907
750	806	766	766	1612	1225	1225	604	449	449
1000	604	431	431	1209	689	689	453	253	253
1250	483	276	276	967	441	441	363	162	162
1500	403	191	191	806	306	306	302	112	112
1750	345	141	141	691	225	225	259	83	83
2000	302	108	108	604	172	172	227	63	63
2250	269	85	85	537	136	136	201	50	50
2500	242	69	69	483	110	110	181	40	40
2750	220	57	57	440	91	91	165	33	33
3000	201	48	48	403	77	77	151	28	28

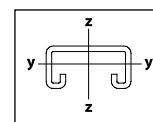
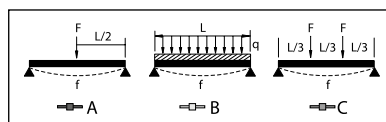
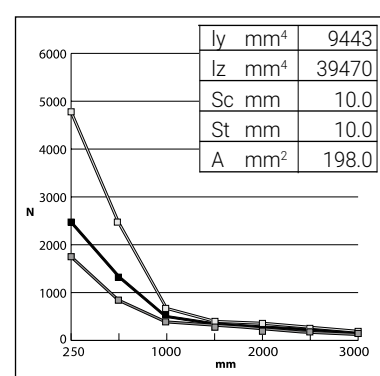

W_{zul} = 160 N/mm
f_{zul} = l/200

* All load ratings in NEWTON (N). The Load based on allowable tension is based on the material yield, an additional Safety Factor of 2 is recommended.

Technical Information

LOADS DATA FOR C-CANTILEVER

C-EOL | 18 X 27 MM | T = 1.25 MM

L (mm)	loading case A			loading case B			loading case C			loading case D		
	F from allowable tension (N)*	F from allowable deflection (N)	allowable load (N)	F from allowable tension (N)*	F from allowable deflection (N)	allowable load (N)	F from allowable tension (N)*	F from allowable deflection (N)	allowable load (N)	F from allowable tension (N)*	F from allowable deflection (N)	allowable load (N)
180	513	542	513	513	723	513	256	920	256	256	271	256
240	385	305	305	385	407	385	192	517	192	192	152	152
300	308	195	195	308	260	260	154	331	154	154	98	98

ly mm ⁴	8791
lz mm ⁴	2788
Sc mm	8.336
St mm	9.665
A mm ²	65.57

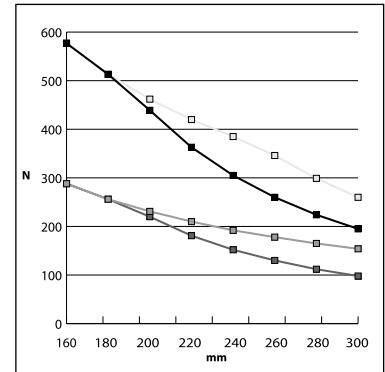

C-EO | 30 X 27 MM | T = 1.5 MM

L (mm)	loading case A			loading case B			loading case C			loading case D		
	F from allowable tension (N)*	F from allowable deflection (N)	allowable load (N)	F from allowable tension (N)*	F from allowable deflection (N)	allowable load (N)	F from allowable tension (N)*	F from allowable deflection (N)	allowable load (N)	F from allowable tension (N)*	F from allowable deflection (N)	allowable load (N)
180	1333	2305	1333	1333	3073	1333	667	3910	667	667	1152	667
240	1000	1296	1000	1000	1729	1000	500	2199	500	500	648	500
300	800	830	800	800	1106	800	400	1408	400	400	415	400
360	667	576	576	667	768	667	333	977	333	333	288	288
420	571	423	423	571	564	564	286	718	286	286	212	212
540	444	256	256	444	341	341	222	434	222	222	128	128
660	364	171	171	364	229	229	182	291	182	182	86	86
780	308	123	123	308	164	164	154	208	154	154	61	61

ly mm ⁴	15800
lz mm ⁴	11853
Sc mm	14.194
St mm	15.807
A mm ²	111.73

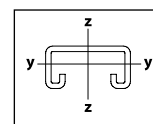
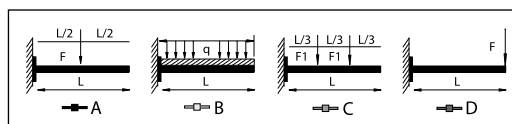
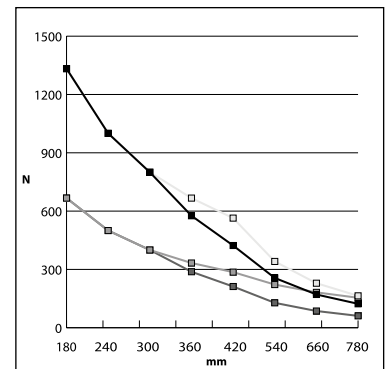

W_{zul} = 160 N/mm
f_{zul} = 1/200

* All load ratings in NEWTON (N). The Load based on allowable tension is based on the material yield, an additional Safety Factor of 2 is recommended.

Technical Information

LOADS DATA FOR C-CANTILEVER

C-E2 | 20 X 24 MM | T = 2.4 MM

L (mm)	loading case A			loading case B			loading case C			loading case D		
	F from allowable tension (N)*	F from allowable deflection (N)	allowable load (N)	F from allowable tension (N)*	F from allowable deflection (N)	allowable load (N)	F from allowable tension (N)*	F from allowable deflection (N)	allowable load (N)	F from allowable tension (N)*	F from allowable deflection (N)	allowable load (N)
200	3255	116	116	1244	1716	1244	622	2184	622	622	644	622
260	2504	69	69	957	1016	957	478	1292	478	478	381	381
300	2170	52	52	829	763	763	415	971	415	415	286	286

ly mm ⁴	29580
lz mm ⁴	8173
Sc mm	9.487
St mm	10.514
A mm ²	158.55

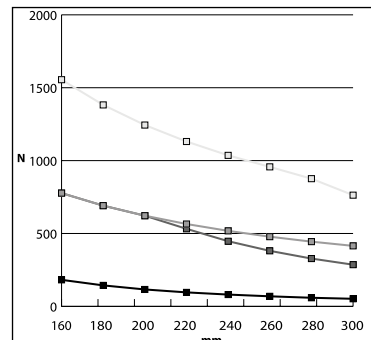

C-E3 | 35 X 35 MM | T = 2.0 MM

L (mm)	loading case A			loading case B			loading case C			loading case D		
	F from allowable tension (N)*	F from allowable deflection (N)	allowable load (N)	F from allowable tension (N)*	F from allowable deflection (N)	allowable load (N)	F from allowable tension (N)*	F from allowable deflection (N)	allowable load (N)	F from allowable tension (N)*	F from allowable deflection (N)	allowable load (N)
250	2152	3075	2152	2152	4101	2152	1076	5217	1076	1076	1538	1076
500	1076	769	769	1076	1025	1025	538	1304	538	538	384	384
750	717	342	342	717	456	456	359	580	359	359	171	171

ly mm ⁴	43390
lz mm ⁴	30510
Sc mm	16.857
St mm	18.144
A mm ²	195.47

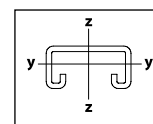
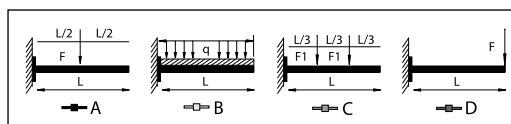
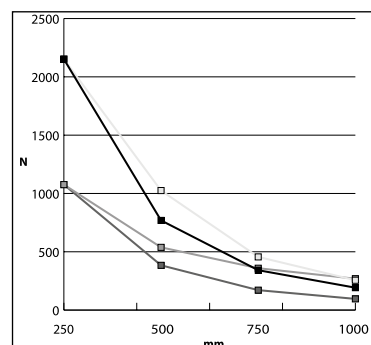

W_{zul} = 160 N/mm
f_{zul} = 1/200

* All load ratings in NEWTON (N). The Load based on allowable tension is based on the material yield, an additional Safety Factor of 2 is recommended.

Technical Information

LOADS DATA FOR C-CANTILEVER

C-E4 | 40 X 38 MM | T = 2.0 MM

L (mm)	loading case A			loading case B			loading case C			loading case D		
	F from allowable tension (N)*	F from allowable deflection (N)	allowable load (N)	F from allowable tension (N)*	F from allowable deflection (N)	allowable load (N)	F from allowable tension (N)*	F from allowable deflection (N)	allowable load (N)	F from allowable tension (N)*	F from allowable deflection (N)	allowable load (N)
200	3561	7070	3561	3561	9427	3561	1780	11994	1780	1780	3535	1780
250	2849	4525	2849	2849	6033	2849	1424	7676	1424	1424	2262	1424
300	2374	3142	2374	2374	4190	2374	1187	5331	1187	1187	1571	1187
350	2035	2309	2035	2035	3078	2035	1017	3916	1017	1017	1154	1017
450	1583	1397	1397	1583	1862	1583	791	2369	791	791	698	698
550	1295	935	935	1295	1247	1247	647	1586	647	647	467	467
650	1096	669	669	1096	892	892	548	1136	548	548	335	335
800	890	442	442	890	589	589	445	750	445	445	221	221

ly mm ⁴	58960
lz mm ⁴	44890
Sc mm	19.836
St mm	20.17
A mm ²	220.1

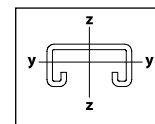
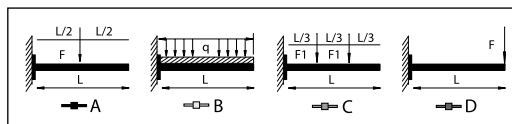
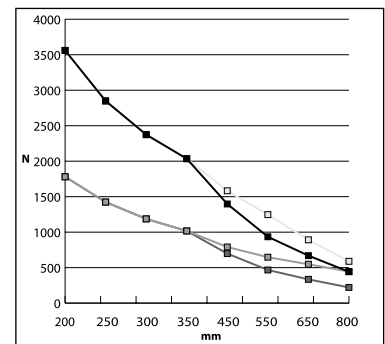

W_{zul} = 160 N/mm
f_{zul} = l/200

LOADS DATA FOR U-PROFILE

UC | 30 X 30 MM | T = 2.0 MM

L (mm)	loading case A			loading case B			loading case C		
	F from allowable tension (N)*	F from allowable deflection (N)	allowable load (N)	F from allowable tension (N)*	F from allowable deflection (N)	allowable load (N)	F from allowable tension (N)*	F from allowable deflection (N)	allowable load (N)
250	2859	12865	2859	5718	20584	5718	2144	7551	2144
500	1429	3216	1429	2859	5146	2859	1072	1888	1072
750	953	1429	953	1906	2287	1906	715	839	715
1000	715	804	715	1429	1286	1286	536	472	472
1250	572	515	515	1144	823	823	429	302	302
1500	476	357	357	953	572	572	357	210	210
1750	408	263	263	817	420	420	306	154	154
2000	357	201	201	715	322	322	268	118	118

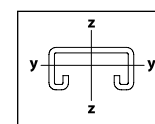
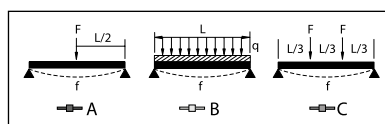
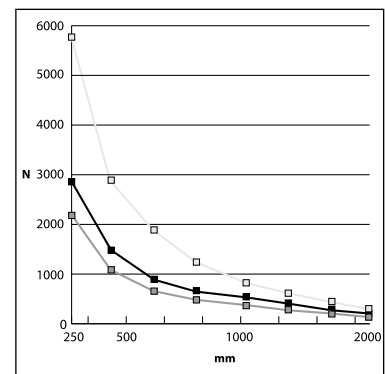

W_{zul} = 160 N/mm
f_{zul} = l/200

* All load ratings in NEWTON (N). The Load based on allowable tension is based on the material yield, an additional Safety Factor of 2 is recommended.

Technical Information

LOADS DATA FOR U-CANTILEVER

CUCS | 30 X 30 MM | T = 2.0 MM

L (mm)	a	loading case A			a	loading case B		
		F from allowable tension (N)*	F from allowable deflection (N)	allowable load (N)		F from allowable tension (N)*	F from allowable deflection (N)	allowable load (N)
250	31	7851	19784	7851	42	5888	13910	5888
300	38	6542	13739	6542	50	4907	9660	4907
400	50	4907	7728	4907	67	3680	5434	3680
500	63	3925	4946	3925	83	2744	3478	2944
600	75	3271	3435	3271	100	2453	2415	2415
800	100	2453	1932	1932	133	1845	1363	1363
1000	125	1963	1236	1236	167	1472	869	869
1300	163	1510	732	732	217	1132	514	514

L (mm)	a	loading case C			a	loading case D		
		F from allowable tension (N)*	F from allowable deflection (N)	allowable load (N)		F from allowable tension (N)*	F from allowable deflection (N)	allowable load (N)
250	63	3925	8243	3925	125	1963	3091	1963
300	75	3271	5724	3271	150	1636	2147	1636
400	100	2453	3220	2453	200	1227	1208	1208
500	125	1963	2061	1963	250	981	773	773
600	150	1636	1431	1431	300	818	537	537
800	200	1227	805	805	400	613	302	302
1000	250	981	515	515	500	491	193	193
1300	325	755	305	305	650	377	114	114

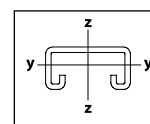
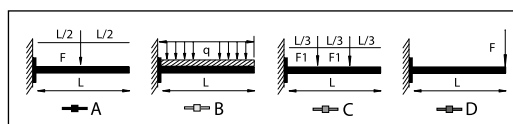
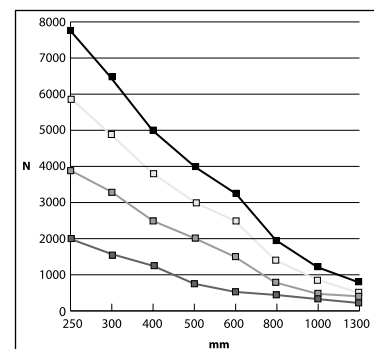

$W_{zul} = 160 \text{ N/mm}$
 $f_{zul} = 1/200$

* All load ratings in NEWTON (N). The Load based on allowable tension is based on the material yield, an additional Safety Factor of 2 is recommended.

Technical Information

LOADS DATA FOR ERISTRUT PROFILE

C15 (LDC) | 21 X 41 MM | T = 1.5 MM

L (mm)	loading case A			loading case B			loading case C		
	F from allowable tension (N)*	F from allowable deflection (N)	allowable load (N)	F from allowable tension (N)*	F from allowable deflection (N)	allowable load (N)	F from allowable tension (N)*	F from allowable deflection (N)	allowable load (N)
500	988	1365	988	1976	2184	1976	741	801	741
1000	494	341	341	988	546	546	371	200	200
1500	329	152	152	659	243	243	247	89	89
2000	247	85	85	494	137	137	185	50	50
2500	198	55	55	395	87	87	148	32	32
3000	165	38	38	329	61	61	124	22	22
3500	141	28	28	282	45	45	106	16	16
4000	124	21	21	247	34	34	93	13	13
4500	110	17	17	220	27	27	82	10	10
5000	99	14	14	198	22	22	74	8	8
5500	90	11	11	180	18	18	67	7	7
6000	82	9	9	165	15	15	62	6	6

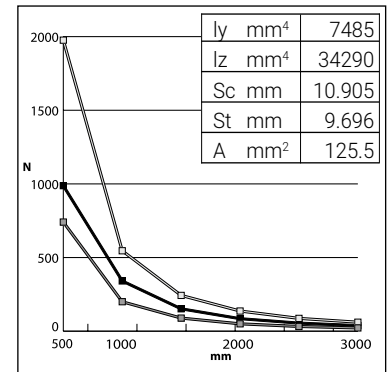

C20 (MDC) | 21 X 41 MM | T = 2.0 MM

L (mm)	loading case A			loading case B			loading case C		
	F from allowable tension (N)*	F from allowable deflection (N)	allowable load (N)	F from allowable tension (N)*	F from allowable deflection (N)	allowable load (N)	F from allowable tension (N)*	F from allowable deflection (N)	allowable load (N)
500	1262	1734	1262	2524	2774	2524	946	1018	946
1000	631	433	433	1262	693	693	473	254	254
1500	421	193	193	841	308	308	315	113	113
2000	315	108	108	631	173	173	237	64	64
2500	252	69	69	505	111	111	189	41	41
3000	210	48	48	421	77	77	158	28	28
3500	180	35	35	361	57	57	135	21	21
4000	158	27	27	315	43	43	118	16	16
4500	140	21	21	280	34	34	105	13	13
5000	126	17	17	252	28	28	95	10	10
5500	115	14	14	229	23	23	86	8	8
6000	105	12	12	210	19	19	79	7	7

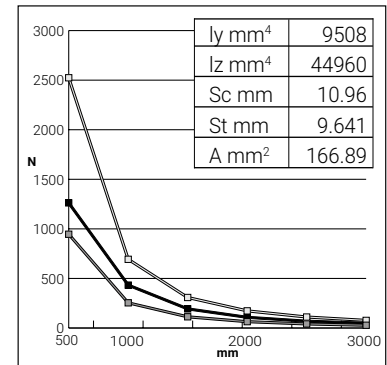

C25 (DC) | 21 X 41 MM | T = 2.5 MM

L (mm)	loading case A			loading case B			loading case C		
	F from allowable tension (N)*	F from allowable deflection (N)	allowable load (N)	F from allowable tension (N)*	F from allowable deflection (N)	allowable load (N)	F from allowable tension (N)*	F from allowable deflection (N)	allowable load (N)
500	1309	1824	1309	2619	2918	2619	982	1070	982
1000	655	456	456	1309	730	730	491	268	268
1500	436	203	203	873	324	324	327	119	119
2000	327	114	114	655	182	182	245	67	67
2500	262	73	73	524	117	117	196	43	43
3000	218	51	51	436	81	81	164	30	30
3500	187	37	37	374	60	60	140	22	22
4000	164	28	28	327	46	46	123	17	17
4500	145	23	23	291	36	36	109	13	13
5000	131	18	18	262	29	29	98	11	11
5500	119	15	15	238	24	24	89	9	9
6000	109	13	13	218	20	20	82	7	7

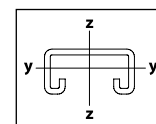
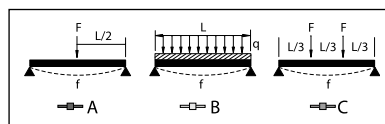
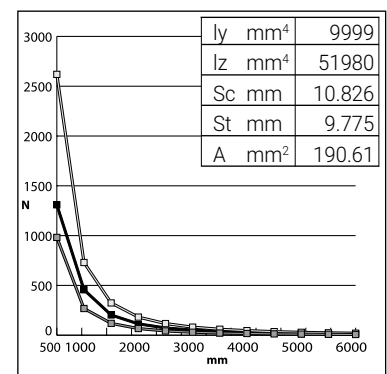

W_{zul} = 160 N/mm
f_{zul} = 1/200

* All load ratings in NEWTON (N). The Load based on allowable tension is based on the material yield, an additional Safety Factor of 2 is recommended.

Technical Information

LOADS DATA FOR ERISTRUT PROFILE

CC25 (DDC) | 2X 21 X 41 MM | T = 2.5 MM

L (mm)	loading case A			loading case B			loading case C		
	F from allowable tension (N)*	F from allowable deflection (N)	allowable load (N)	F from allowable tension (N)*	F from allowable deflection (N)	allowable load (N)	F from allowable tension (N)*	F from allowable deflection (N)	allowable load (N)
500	3506	10291	3506	7011	16466	7011	2629	6040	2629
1000	1753	2573	1753	3506	4116	3506	1315	1510	1315
1500	1169	1143	1143	2337	1830	1830	876	671	671
2000	876	643	643	1753	1029	1029	657	378	378
2500	701	412	412	1402	659	659	526	242	242
3000	584	286	286	1169	457	457	438	168	168
3500	501	210	210	1002	336	336	376	123	123
4000	438	161	161	876	257	257	329	94	94
4500	390	127	127	779	203	203	292	75	75
5000	351	103	103	701	165	165	263	60	60
5500	319	85	85	637	136	136	239	50	50
6000	292	71	71	584	114	114	219	42	42

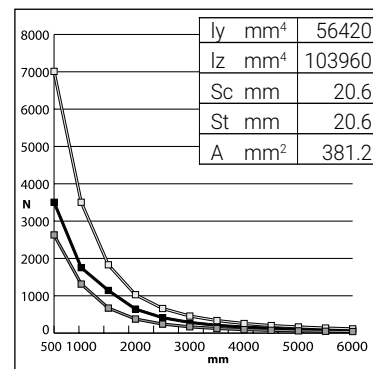

A15 (LAC) | 41 X 41 MM | T = 1.5 MM

L (mm)	loading case A			loading case B			loading case C		
	F from allowable tension (N)*	F from allowable deflection (N)	allowable load (N)	F from allowable tension (N)*	F from allowable deflection (N)	allowable load (N)	F from allowable tension (N)*	F from allowable deflection (N)	allowable load (N)
500	2643	7575	2643	5287	12120	5287	1983	4446	1983
1000	1322	1894	1322	2643	3030	2643	991	1112	991
1500	881	842	842	1762	1347	1347	661	494	494
2000	661	473	473	1322	758	758	496	278	278
2500	529	303	303	1057	485	485	397	178	178
3000	441	210	210	881	337	337	330	124	124
3500	378	155	155	755	247	247	283	91	91
4000	330	118	118	661	189	189	248	69	69
4500	294	94	94	587	150	150	220	55	55
5000	264	76	76	529	121	121	198	44	44
5500	240	63	63	481	100	100	180	37	37
6000	220	53	53	441	84	84	165	31	31

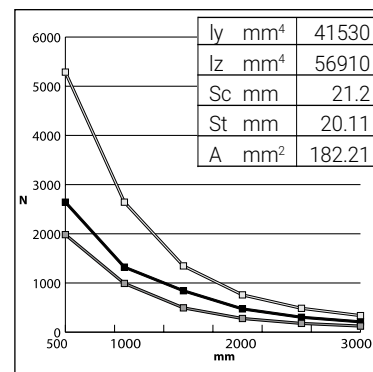

A20 (MAC) | 41 X 41 MM | T = 2.0 MM

L (mm)	loading case A			loading case B			loading case C		
	F from allowable tension (N)*	F from allowable deflection (N)	allowable load (N)	F from allowable tension (N)*	F from allowable deflection (N)	allowable load (N)	F from allowable tension (N)*	F from allowable deflection (N)	allowable load (N)
500	3470	9901	3470	6941	15841	6941	2603	5811	2603
1000	1735	2475	1735	3470	3960	3470	1301	1453	1301
1500	1157	1100	1100	2314	1760	1760	868	646	646
2000	868	619	619	1735	990	990	651	363	363
2500	694	396	396	1388	634	634	521	232	232
3000	578	275	275	1157	440	440	434	161	161
3500	496	202	202	992	323	323	372	119	119
4000	434	155	155	868	248	248	325	91	91
4500	386	122	122	771	196	196	289	72	72
5000	347	99	99	694	158	158	260	58	58
5500	315	82	82	631	131	131	237	48	48
6000	289	69	69	578	110	110	217	40	40

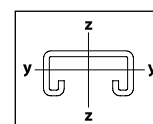
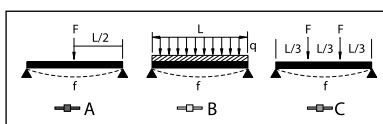
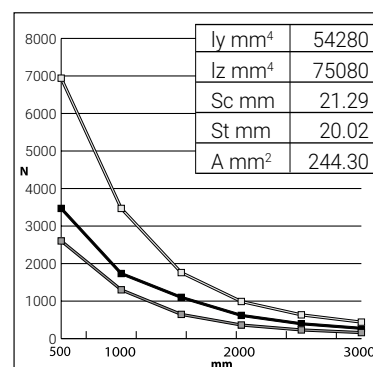

W_{zul} = 160 N/mm
f_{zul} = l/200

* All load ratings in NEWTON (N). The Load based on allowable tension is based on the material yield, an additional Safety Factor of 2 is recommended.

Technical Information

LOADS DATA FOR ERISTRUT PROFILE

AA25 (AC) | 41 X 41 MM | T = 2.5 MM

L (mm)	loading case A			loading case B			loading case C		
	F from allowable tension (N)*	F from allowable deflection (N)	allowable load (N)	F from allowable tension (N)*	F from allowable deflection (N)	allowable load (N)	F from allowable tension (N)*	F from allowable deflection (N)	allowable load (N)
500	3811	10980	3811	7622	17569	7622	2858	6445	2858
1000	1905	2745	1905	3811	4392	3811	1429	1611	1429
1500	1270	1220	1220	2541	1952	1952	953	716	716
2000	953	686	686	1905	1098	1098	715	403	403
2500	762	439	439	1524	703	703	572	258	258
3000	635	305	305	1270	488	488	476	179	179
3500	544	224	224	1089	359	359	408	132	132
4000	476	172	172	953	275	275	357	101	101
4500	423	136	136	847	217	217	318	80	80
5000	381	110	110	762	176	176	286	64	64
5500	346	91	91	693	145	145	260	53	53
6000	318	76	76	635	122	122	238	45	45

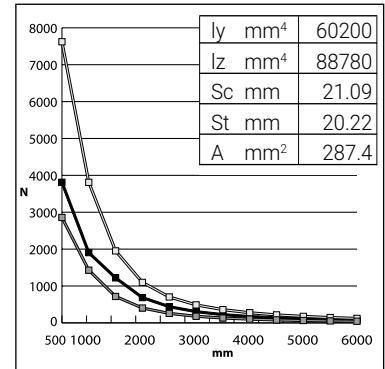

AA25 (AAC) | 2X 41 X 41 MM | T = 2.5 MM

L (mm)	loading case A			loading case B			loading case C		
	F from allowable tension (N)*	F from allowable deflection (N)	allowable load (N)	F from allowable tension (N)*	F from allowable deflection (N)	allowable load (N)	F from allowable tension (N)*	F from allowable deflection (N)	allowable load (N)
500	11015	64825	11015	22030	103720	22030	8261	38049	8261
1000	5507	16206	5507	11015	25930	11015	4131	9512	4131
1500	3672	7203	3672	7343	11524	7343	2754	4228	2754
2000	2754	4052	2754	5507	6482	5507	2065	2378	2065
2500	2203	2593	2203	4406	4149	4149	1652	1522	1522
3000	1836	1801	1801	3672	2881	2881	1377	1057	1057
3500	1574	1323	1323	3147	2117	2117	1180	777	777
4000	1377	1013	1013	2754	1621	1621	1033	595	595
4500	1224	800	800	2448	1280	1280	918	470	470
5000	1101	648	648	2203	1037	1037	826	380	380
5500	1001	536	536	2003	857	857	751	314	314
6000	918	450	450	1836	720	720	688	264	264

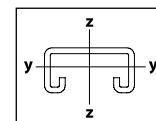
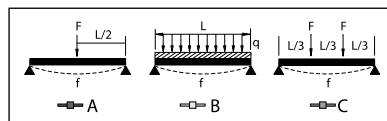
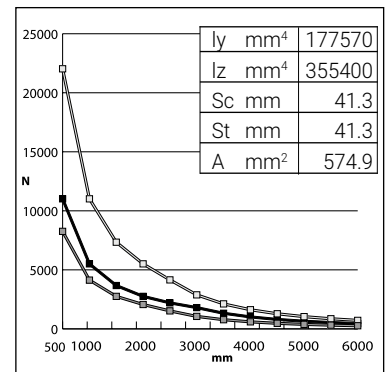

! $W_{zul} = 160 \text{ N/mm}$
 $f_{zul} = 1/200$

* All load ratings in NEWTON (N). The Load based on allowable tension is based on the material yield, an additional Safety Factor of 2 is recommended.

Technical Information

LOADS DATA FOR ERISTRUT PROFILE

A25 (AS) | 41 X 41 MM | T = 2.5 MM

L (mm)	loading case A			loading case B			loading case C		
	F from allowable tension (N)*	F from allowable deflection (N)	allowable load (N)	F from allowable tension (N)*	F from allowable deflection (N)	allowable load (N)	F from allowable tension (N)*	F from allowable deflection (N)	allowable load (N)
500	4014	11243	4014	8027	17989	8027	3010	6599	3010
1000	2007	2811	2007	4014	4497	4014	1505	1650	1505
1500	1338	1249	1249	2676	1999	1999	1003	733	733
2000	1003	703	703	2007	1124	1124	753	412	412
2500	803	450	450	1605	720	720	602	264	264
3000	669	312	312	1338	500	500	502	183	183
3500	573	229	229	1147	367	367	430	135	135
4000	502	176	176	1003	281	281	376	103	103
4500	446	139	139	892	222	222	334	81	81
5000	401	112	112	803	180	180	301	66	66
5500	365	93	93	730	149	149	274	55	55
6000	334	78	78	669	125	125	251	46	46

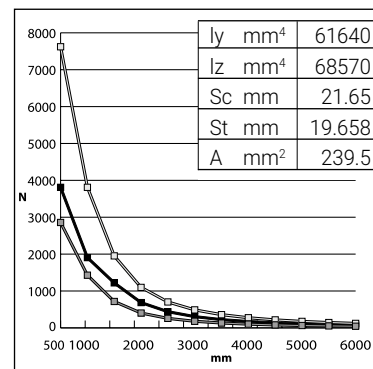

D25 (MC) | 62 X 41 MM | T = 2.5 MM

L (mm)	loading case A			loading case B			loading case C		
	F from allowable tension (N)*	F from allowable deflection (N)	allowable load (N)	F from allowable tension (N)*	F from allowable deflection (N)	allowable load (N)	F from allowable tension (N)*	F from allowable deflection (N)	allowable load (N)
500	7437	32427	7437	14873	51883	14873	5577	19033	5577
1000	3718	8107	3718	7437	12971	7437	2789	4758	2789
1500	2479	3603	2479	4958	5765	4958	1859	2115	1859
2000	1859	2027	1859	3718	3243	3243	1394	1190	1190
2500	1487	1297	1297	2975	2075	2075	1115	761	761
3000	1239	901	901	2479	1441	1441	930	529	529
3500	1062	662	662	2125	1059	1059	797	388	388
4000	930	507	507	1859	811	811	697	297	297
4500	826	400	400	1653	641	641	620	235	235
5000	744	324	324	1487	519	519	558	190	190
5500	676	268	268	1352	429	429	507	157	157
6000	620	225	225	1239	360	360	465	132	132

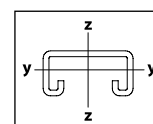
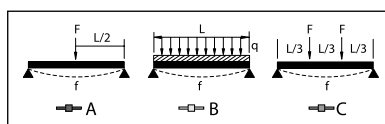
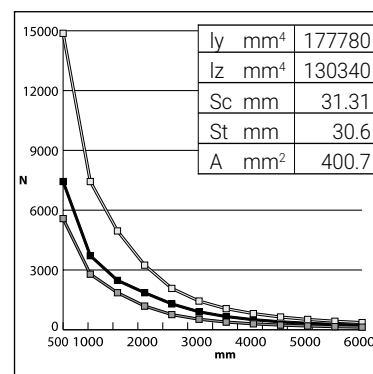

! $W_{zul} = 160 \text{ N/mm}$
 $f_{zul} = 1/200$

* All load ratings in NEWTON (N). The Load based on allowable tension is based on the material yield, an additional Safety Factor of 2 is recommended.

Technical Information

LOADS DATA FOR ERISTRUT PROFILE

DD25 (MMC) | 2X 62 X 41 MM | T = 2.5 MM

L (mm)	loading case A			loading case B			loading case C		
	F from allowable tension (N)*	F from allowable deflection (N)	allowable load (N)	F from allowable tension (N)*	F from allowable deflection (N)	allowable load (N)	F from allowable tension (N)*	F from allowable deflection (N)	allowable load (N)
500	22862	201661	22862	45724	322658	45724	17147	118366	17147
1000	11431	50415	11431	22862	80665	22862	8573	29591	8573
1500	7621	22407	7621	15241	35851	15241	5716	13152	5716
2000	5716	12604	5716	11431	20166	11431	4287	7398	4287
2500	4572	8066	4572	9145	12906	9145	3429	4735	3429
3000	3810	5602	3810	7621	8963	7621	2858	3288	2858
3500	3266	4116	3266	6532	6585	6532	2450	2416	2416
4000	2858	3151	2858	5716	5042	5042	2143	1849	1849
4500	2540	2490	2490	5080	3983	3983	1905	1461	1461
5000	2286	2017	2017	4572	3227	3227	1715	1184	1184
5500	2078	1667	1667	4157	2667	2667	1559	978	978
6000	1905	1400	1400	3810	2241	2241	1429	822	822

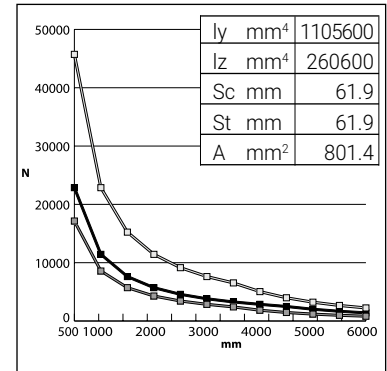

E25 (KC) | 83 X 41 MM | T = 2.5 MM

L (mm)	loading case A			loading case B			loading case C		
	F from allowable tension (N)*	F from allowable deflection (N)	allowable load (N)	F from allowable tension (N)*	F from allowable deflection (N)	allowable load (N)	F from allowable tension (N)*	F from allowable deflection (N)	allowable load (N)
500	11844	69111	11844	23687	110578	23687	8883	40565	8883
1000	5922	17278	5922	11844	27645	11844	4441	10141	4441
1500	3948	7679	3948	7896	12286	7896	2961	4507	2961
2000	2961	4319	2961	5922	6911	5922	2221	2535	2221
2500	2369	2764	2369	4737	4423	4423	1777	1623	1623
3000	1974	1920	1920	3948	3072	3072	1480	1127	1127
3500	1692	1410	1410	3384	2257	2257	1269	828	828
4000	1480	1080	1080	2961	1728	1728	1110	634	634
4500	1316	853	853	2632	1365	1365	987	501	501
5000	1184	691	691	2369	1106	1106	888	406	406
5500	1077	571	571	2153	914	914	808	335	335
6000	987	480	480	1974	768	768	740	282	282

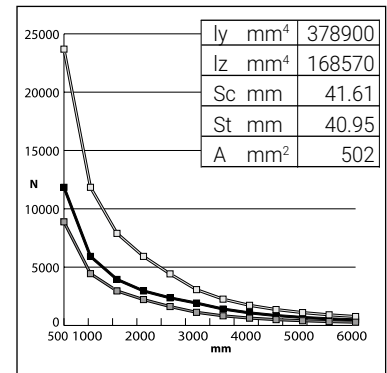

EE25 (KKC) | 2X 83 X 41 MM | T = 2.5 MM

L (mm)	loading case A			loading case B			loading case C		
	F from allowable tension (N)*	F from allowable deflection (N)	allowable load (N)	F from allowable tension (N)*	F from allowable deflection (N)	allowable load (N)	F from allowable tension (N)*	F from allowable deflection (N)	allowable load (N)
500	37850	445238	37850	75699	712381	75699	28387	261333	28387
1000	18925	111310	18925	37850	178095	37850	14194	65333	14194
1500	12617	49471	12617	25233	79153	25233	9462	29037	9462
2000	9462	27827	9462	18925	44524	18925	7097	16333	7097
2500	7570	17810	7570	15140	28495	15140	5677	10453	5677
3000	6308	12368	6308	12617	19788	12617	4731	7259	4731
3500	5407	9086	5407	10814	14538	10814	4055	5333	4055
4000	4731	6957	4731	9462	11131	9462	3548	4083	3548
4500	4206	5497	4206	8411	8795	8411	3154	3226	3154
5000	3785	4452	3785	7570	7124	7124	2839	2613	2613
5500	3441	3680	3441	6882	5887	5887	2581	2160	2160
6000	3154	3092	3092	6308	4947	4947	2366	1815	1815

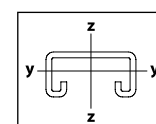
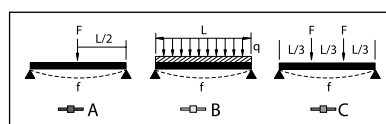
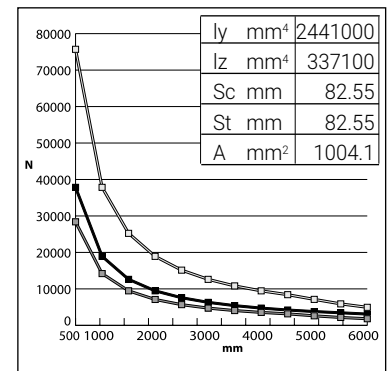

$$W_{zul} = 160 \text{ N/mm}$$

$$f_{zul} = l/200$$

* All load ratings in NEWTON (N). The Load based on allowable tension is based on the material yield, an additional Safety Factor of 2 is recommended.

Technical Information

LOADS DATA FOR ERISTRUT PROFILE

KC25 (CDC) | 21 X 41 MM | T = 2.5 MM

L (mm)	F from allowable tension (N)*	loading case A		F from allowable tension (N)*	loading case B		F from allowable tension (N)*	loading case C		F from allowable tension (N)*	loading case D	
		F from allowable deflection (N)	allowable load (N)		F from allowable deflection (N)	allowable load (N)		F from allowable deflection (N)	allowable load (N)		F from allowable deflection (N)	allowable load (N)
150	2182	2800	2182	2182	3733	2182	1091	4750	1091	1091	1400	1091
300	1091	700	700	1091	933	933	546	1187	546	546	350	350
450	727	311	311	727	415	415	364	528	364	364	156	156

ly mm ⁴	9999
lz mm ⁴	51980
Sc mm	10.826
St mm	9.775
A mm ²	190.61

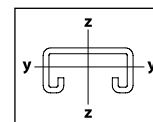
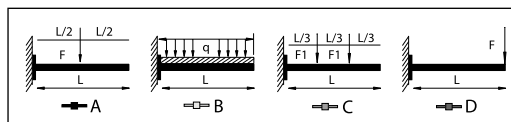
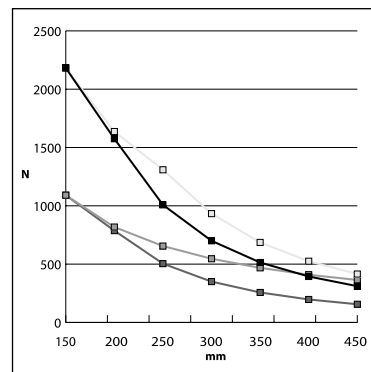

W_{zul} = 160 N/mm
f_{zul} = 1/200

LOADS DATA FOR ERISTRUT CANTILEVER

KCC25 (CDDC) | 2X 21 X 41 MM | T = 2.5 MM

L (mm)	F from allowable tension (N)*	loading case A		F from allowable tension (N)*	loading case B		F from allowable tension (N)*	loading case C		F from allowable tension (N)*	loading case D	
		F from allowable deflection (N)	allowable load (N)		F from allowable deflection (N)	allowable load (N)		F from allowable deflection (N)	allowable load (N)		F from allowable deflection (N)	allowable load (N)
300	2921	3949	2921	2921	5266	2921	1461	6700	1461	1461	1975	1461
450	1948	1755	1755	1948	2340	1948	974	2978	974	974	878	878
600	1461	987	987	1461	1316	1316	730	1675	730	730	494	494

ly mm ⁴	56420
lz mm ⁴	103960
Sc mm	20.6
St mm	20.6
A mm ²	381.2

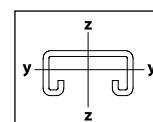
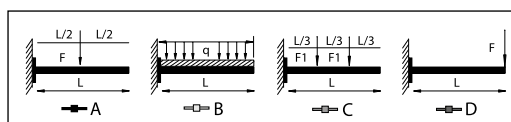
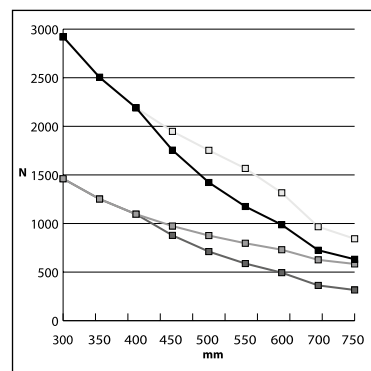

W_{zul} = 160 N/mm
f_{zul} = 1/200

* All load ratings in NEWTON (N). The Load based on allowable tension is based on the material yield, an additional Safety Factor of 2 is recommended.

Technical Information

LOADS DATA FOR ERISTRUT CANTILEVER

KA25 (CAC) | 41 X 41 MM | T = 2.5 MM

L (mm)	F from allowable tension (N)*	loading case A		F from allowable tension (N)*	loading case B		F from allowable tension (N)*	loading case C		F from allowable tension (N)*	loading case D	
		F from allowable deflection (N)	allowable load (N)		F from allowable deflection (N)	allowable load (N)		F from allowable deflection (N)	allowable load (N)		F from allowable deflection (N)	allowable load (N)
150	6351	16856	6351	6351	22475	6351	3176	28595	3176	3176	8428	3176
200	4764	9482	4764	4764	12642	4764	2382	16085	2382	2382	4741	2382
300	3176	4214	3176	3176	5619	3176	1588	7149	1588	1588	2107	1588
450	2117	1873	1873	2117	2497	2117	1059	3177	1059	1059	936	936
500	1905	1517	1517	1905	2023	1905	953	2574	953	953	759	759
600	1588	1054	1054	1588	1405	1405	794	1787	794	794	527	527
750	1270	674	674	1270	899	899	635	1144	635	635	337	337
1000	953	379	379	953	506	506	476	643	476	476	190	190
1200	794	263	263	794	351	351	397	447	397	397	132	132
1500	635	169	169	635	225	225	318	286	286	318	84	84
2000	476	95	95	476	126	126	238	161	161	238	47	47

ly mm ⁴	60200
lz mm ⁴	88780
Sc mm	21.09
St mm	20.22
A mm ²	287.4

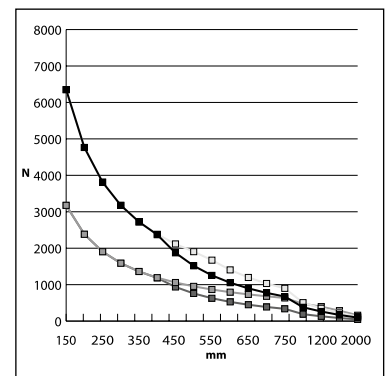

KAA25 (CAAC) | 2X 41 X 41 MM | T = 2.5 MM

L (mm)	F from allowable tension (N)*	loading case A		F from allowable tension (N)*	loading case B		F from allowable tension (N)*	loading case C		F from allowable tension (N)*	loading case D	
		F from allowable deflection (N)	allowable load (N)		F from allowable deflection (N)	allowable load (N)		F from allowable deflection (N)	allowable load (N)		F from allowable deflection (N)	allowable load (N)
300	9179	24878	9179	9179	33171	9179	4590	42204	4590	4590	12439	4590
500	5507	8956	5507	5507	11941	5507	2754	15193	2754	2754	4478	2754
750	3672	3980	3672	3672	5307	3672	1836	6753	1836	1836	1990	1836
1050	2623	2031	2031	2623	2708	2623	1311	3445	1311	1311	1015	1015

ly mm ⁴	177570
lz mm ⁴	355400
Sc mm	41.3
St mm	41.3
A mm ²	574.9

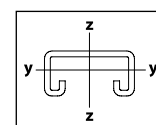
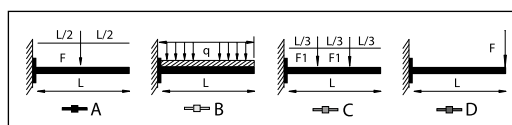
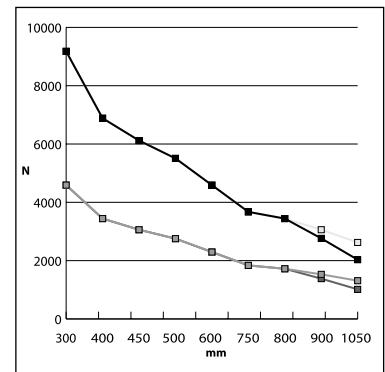

W_{zul} = 160 N/mm
f_{zul} = 1/200

* All load ratings in NEWTON (N). The Load based on allowable tension is based on the material yield, an additional Safety Factor of 2 is recommended.

Technical Information

LOADS DATA FOR ERISTRUT CANTILEVER

CTRI | T = 1.5 MM

L (mm)	loading case A			loading case B			loading case C			loading case D		
	F from allowable tension (N)*	F from allowable deflection (N)	allowable load (N)	F from allowable tension (N)*	F from allowable deflection (N)	allowable load (N)	F from allowable tension (N)*	F from allowable deflection (N)	allowable load (N)	F from allowable tension (N)*	F from allowable deflection (N)	allowable load (N)
120	9179	24878	3000	9179	33171	3000	4590	42204	1500	4590	12439	1500
160	6884	13994	2500	6884	18659	2500	3442	23740	1250	3442	6997	1250
210	6119	11057	2250	6119	14743	2250	3060	18757	1125	3060	5528	1125
260	5507	8956	1750	5507	11941	1750	2754	15193	875	2754	4478	875
310	4590	6220	1500	4590	8293	1500	2295	10551	750	2295	3110	750
410	3672	3980	1500	3672	5307	1500	1836	6753	750	1836	1990	750
510	3442	3498	1500	3442	4665	1500	1721	5935	750	1721	1749	750
610	3060	2764	1250	3060	3686	1250	1530	4689	625	1530	1382	625

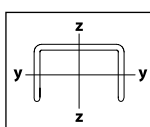
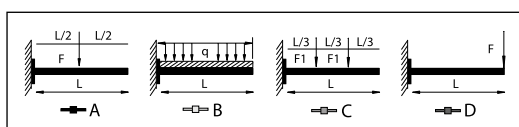

$W_{zul} = 160 \text{ N/mm}$
 $f_{zul} = l/200$

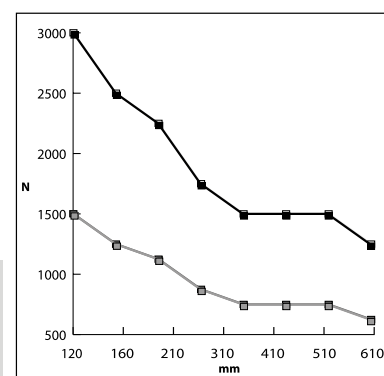

* All load ratings in NEWTON (N). The Load based on allowable tension is based on the material yield, an additional Safety Factor of 2 is recommended.

LOADS DATA FOR ROD LOCK STRUT

STRUT TYPE: C | 21 X 41 MM | STRUT THICKNESS = 1.5 MM

Part Number	Article Number	Rod Size	Span Between Two Rods A (mm)	Overall Strut Length L (mm)	F* (N)
CRLP1M8L550	390029	M8	550	600	2306
CRLP1M8L750	390030	M8	750	800	1307
CRLP1M10L550	390035	M10	550	600	2306
CRLP1M10L750	390036	M10	750	800	1307

Note:
Product must be installed with the open side of the channel facing up.

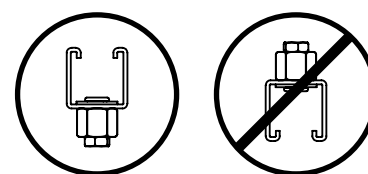

STRUT TYPE: A | 41 X 41 MM | STRUT THICKNESS = 2.5 MM

Part Number	Article Number	Rod Size	Span Between Two Rods A (mm)	Overall Strut Length L (mm)	F* (N)
CRLP2M8L550	390031	M8	550	600	7484
CRLP2M8L750	390032	M8	750	800	5488
CRLP2M8L950	390033	M8	950	1000	4333
CRLP2M8L1050	390034	M8	1050	1100	3920
CRLP2M10L550	390037	M10	550	600	7484
CRLP2M10L750	390038	M10	750	800	5488
CRLP2M10L950	390039	M10	950	1000	4333
CRLP2M10L1050	390040	M10	1050	1100	3920

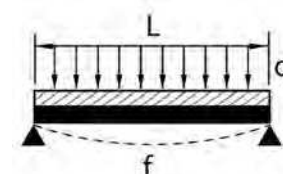
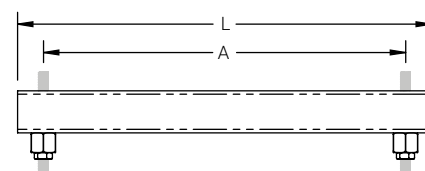

* All load ratings in NEWTON (N). The Capacity ratings for strut (F) assumes a uniformly distributed load and includes a hole factor of 0.92 ; it is based on the material yield and maximum allowable deflection, an additional Safety Factor of 2 is recommended. For indoor applications only..

Technical Information

SPRING STEEL CLIPS

Description

nVent CADDY clips are manufactured from heat treated spring steel and, as a single or combined fixing system will primarily apply to steel beam applications.

The fixing method relies on the use of the spring retention force, loads of up to 90 kg (with a 4:1 safety factor unless stated otherwise) can be carried through the clamping force.

Installation Advice

The installation of nVent CADDY spring steel clips is simple and easy:

In each box of product you will find an instruction sheet with appropriate technical information.

Basic Guidelines

NVENT CADDY DOES NOT RECOMMEND THE INSTALLATION OF NVENT CADDY CLIPS ONTO ALUMINIUM SECTION:

- Because aluminium is a softer material, the clamping effect would be reduced.
- The bi-metal connection between the aluminium and zinc coated clips would create a galvanic corrosive reaction causing the aluminium to corrode.
- Spring steel fasteners are for indoor use in non-corrosive environments. Mild steel fasteners can be used outdoors in humid or mildly corrosive environments. Not to be used in certain areas such as over indoor pools, etc. nVent CADDY Clips should not be re-used after removal.

NEVER APPLY ADDITIONAL HOT DIP GALVANISING TO SPRING STEEL CLIPS:

- This would reduce or eliminate the spring steel retention force.
- The appropriate corrosion protection has already been applied.

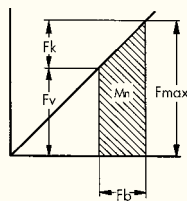

Explanation of the diagram:

- pre-tension - **Fv**
- clamping force - **Fk**
- max. spring tension - **Fmax**
- clamping range - **Fb**
- usable action of spring - **Mn**

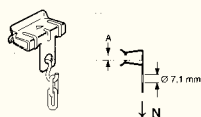

Code	A (mm)	↓ N
2H4	2-3	700
4H24	3-8	900
4H58	8-14	900
4H912	14-20	900

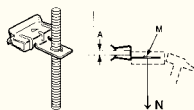

Code	A (mm)	M	↓ N
4H24i	3-8	M6	150
4H58i	8-14	M6	150

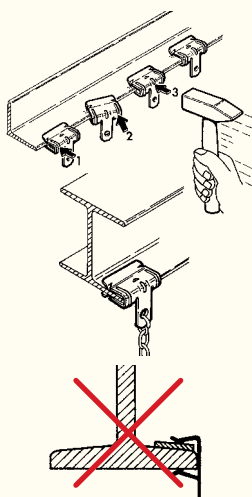

Do not insert any secondary component between the beam and the nVent CADDY clip.

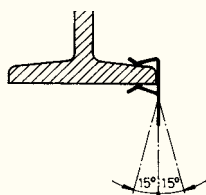

Up to a 15 degree inclination from the vertical axis is acceptable.

"BOLT ON"

Description

For the installation of this type of nVent CADDY fixing, some technical details have to be taken into consideration.

In particular the torque required, as indicated on the required technical information.

Installation Advice

The 8.8 grade high tensile steel screw has a cupped or hollow cone point of contact to EN ISO 4753 (CP).

This ensures a constant contact pressure with a high resistance to loosening or unscrewing.

The endurance of a clamped connection is determined by the torque required.

By tightening the bolt, an initial stress F1 is applied to the clamp.

If the initial stress F1 and the load F2 are on or close to the same axis or close to each other, the following formula applies:

Indirect Clamp

In this application, the bolt setting forces are transferred to the clamping component.

Bolts to tensile stress are 8.8 grade high tensile steel, to DIN ISO 939.

In most applications, nVent CADDY clamping components are tightened with an open-ended or ring spanner. The table below gives a "guideline value" derived from experience for the force and leverage length required for grades 6.8 and 8.8.

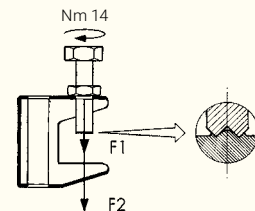
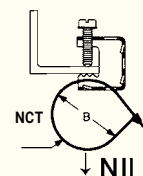
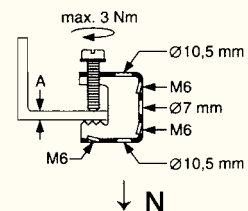
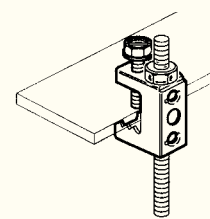

Bolt grade 8.8 high tensile steel, EN ISO 898-1

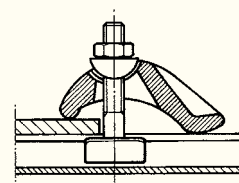

Screw Size	Manual Force (N)	Wrench Length (mm)
M6	375	110
M8	380	120
M10	390	170
M12	400	260
M16	430	530

E. Index – Article Number / Part Number

Article Number	Part Number	Page	Article Number	Part Number	Page	Article Number	Part Number	Page
159441	TDHP2	5-20	170180	4H24CTBW	1-12	171590	J2	5-10
159442	TDHP2PR10	5-20	170190	4H58CTBW	1-12	171600	CTS1	5-42
160000	160000	5-15	170200	4H912CTBW	1-12	171640	4H912ST3	1-15
160010	160010	5-15	170210	2H4CTBB	1-12	171670	4G16LS	2-5
160020	T1058	5-15	170220	4H24CTBB	1-12	171680	4G24M11	2-7
160030	160030	5-15	170230	4G16H	2-6	171690	122	5-9
160050	812M24SM	1-5	170240	4H58CTBB	1-12	171700	123	5-9
160060	812M58SM	1-5	170250	4H58I	5-14	171710	4G24M16	2-7
160070	812M912SM	1-5	170260	4H912CTBB	1-12	171720	20M24SM	1-5
160075	812EM1318	1-4	170280	4H24CTBRS1	1-12	171730	4G24M25	2-7
160120	812EM24	1-4	170300	4H58CTBRS1	1-12	171740	16EM24	1-4
160130	812EM58	1-4	170310	4H912CTBRS1	1-12	171750	6EM58	1-4
160140	812EM912	1-4	170350	J2CT	1-16	171760	MSS58	9-49
160145	812M1318SM	1-5	170370	J1	5-10	171770	MSS912	9-49
160180	EBC812MSM	1-6	170380	EBC	5-3	171775	4H1318ST3	1-15
160200	EBC812M	1-6	170381	4QTIBC	5-15	171800	20EM24	1-4
160220	J1T10	5-17	170400	ATA4I	2-2	171840	4G24M11WH	2-7
160230	J2T10	5-17	170420	ATS4I	2-2	171850	EM912SM	5-12
160290	4G24WN	2-7	170430	4H58CTS1	1-13	171855	EM1318SM	5-12
160310	MFAM6	11-13	170450	CT	5-42	171860	4G24M16WH	2-7
160340	M10GTD1217	5-23	170470	2H41214A	1-14	171900	4G16M16	2-6
160370	M10GTD1722	5-23	170480	4H241012A	1-14	171950	20EM58	1-4
160440	EM24SM16	5-12	170490	4G24H	2-8	171960	24EM24	1-4
160450	EM58SM16	5-12	170500	4G24HWH	2-8	171970	24EM58	1-4
160460	EM912SM16	5-12	170530	EM24SM	5-12	171980	6M58SM	1-5
160470	4H24CTIN	1-14	170610	J1CT	1-16	172030	MSS24	9-49
160480	4H58CTIN	1-14	170630	4H241214A	1-14	172060	EM58SM	5-12
160490	4H912CTIN	1-14	170640	4H241214B	1-15	172150	8P24	1-2
160500	4H24CTS1	1-13	170650	4Z34	5-30	172160	8P58	1-2
160510	SCA	1-11	170670	K12	1-17	172170	EM24SP25	5-11
160640	M6VKR	5-22	170680	K16	1-17	172180	EM58SP25	5-11
160650	M8VKR	5-22	170690	K20	1-17	172220	EM24SM16SP10	5-12
160660	M10VKR	5-22	170700	4H912CTS1	1-13	172230	EM58SM16SP10	5-12
160700	OCDC68MM	5-23	170720	6Z34	5-30	172280	4G24HWHSP25	2-8
160710	OCDC68MM	5-23	170790	6M	1-19	172290	4G24M16WHSP25	2-7
160720	OCDC68MM	5-23	170840	2H41214B	1-15	172300	4G24M25WHSP25	2-7
160820	BTF24	1-28	170850	4H241012B	1-15	172320	4H24SP25	5-13
160830	BTF58	1-28	170880	PCS1	1-18	172340	4H24ST3SP25	1-15
160840	BTF912	1-28	170881	PCS2	1-18	172350	4H58SP25	5-13
160880	CJ6S	3-3	170896	4QTIGBSF	5-27	172360	4H58CTSP25	1-13
160890	WC812	1-21	170900	M8TI	5-26	172370	4H58ST3SP25	1-15
160991	MFSE	3-2	170906	M8TIBGBSF	5-28	172380	4H912SP25	5-13
170010	2H4	5-13	170910	M10TI	5-26	172390	4H912CTSP25	1-13
170011	KBT	1-27	170916	M10TIBGBSF	5-28	172400	4H912ST3SP25	1-15
170020	4H24	5-13	171060	4Z34812M	1-18	172420	S40EGSP25	2-4
170030	4H58	5-13	171090	6Z34812M	1-18	172430	EBCSP25	5-3
170040	4H912	5-13	171120	AB	5-29	172580	EBC6M	1-6
170045	4H1318	5-13	171130	8P	1-19	172590	EBC16M	1-6
170050	EM24	5-11	171150	12P	1-19	172600	EBC20M	1-6
170060	EM58	5-11	171170	16P	1-19	172610	EBC24M	1-6
170070	EM912	5-11	171230	8P12P	1-20	172620	EBC32M	1-6
170075	EM1318	5-11	171250	12P12P	1-20	172650	EBC6MSM	1-6
170100	16M	1-19	171260	12P16P	1-20	172660	EBC16MSM	1-6
170110	20M	1-19	171270	16P16P	1-20	172670	EBC20MSM	1-6
170120	24M	1-19	171470	EER	5-22	172680	EBC24MSM	1-6
170130	32M	1-19	171490	16EM58	1-4	172690	EBC32MSM	1-6
170140	4H24IM11	5-14	171500	4H24ST3	1-15	172920	GR50	4-18
170150	4H24I	5-14	171530	4H58ST3	1-15	172921	PTB6	4-18
170160	4H58IM11	5-14	171550	4H912ST3S1	1-15	172922	PTB8	4-18
170170	2H4CTBW	1-12	171560	6WN	2-8	172950	4Z34CTS	1-28

E. Index – Article Number / Part Number

Article Number	Part Number	Page	Article Number	Part Number	Page	Article Number	Part Number	Page
172960	6Z34CTS	1-28	175060	J2M10TI	5-17	179407	4100500EG	9-3
172990	EBCM6MA	5-14	175070	122M10TI	5-16	179408	4100600EG	9-3
173000	EBCM8MA	5-14	175100	8P912	1-2	179409	4100800EG	9-3
173120	EERTIM6	5-22	175110	12P24	1-2	179420	4010100EG	9-2
173130	EERTIM8	5-22	175120	12P58	1-2	179421	4010125EG	9-2
173140	EERTIM10	5-22	175130	12P912	1-2	179422	4010150EG	9-2
173420	2H4ST3	1-15	175140	16P24	1-2	179423	4010200EG	9-2
173446	ABGBSF	5-29	175150	16P58	1-2	179424	4010250EG	9-2
173460	IDSM16	2-5	175160	16P912	1-2	179425	4010300EG	9-2
173550	6EM24	1-4	175170	8P4SM	1-3	179426	4010400EG	9-2
173570	16EM912	1-4	175180	8P24SM	1-3	179427	4010500EG	9-2
173580	20EM912	1-4	175190	8P58SM	1-3	179428	4010600EG	9-2
173590	24EM912	1-4	175200	8P912SM	1-3	179429	4010800EG	9-2
173600	32EM24	1-4	175210	12P4SM	1-3	179430	4011000EG	9-2
173610	32EM58	1-4	175220	12P24SM	1-3	179431	4011200EG	9-2
173620	32EM912	1-4	175230	12P58SM	1-3	179521	4010350EG	9-2
173640	6M24SM	1-5	175240	12P912SM	1-3	179610	4H24S1	5-13
173650	6M912SM	1-5	175250	16P4SM	1-3	179620	4H58S1	5-13
173720	16M24SM	1-5	175260	16P24SM	1-3	179630	4H912S1	5-13
173730	16M58SM	1-5	175270	16P58SM	1-3	179650	8M24SMS1	1-5
173740	16M912SM	1-5	175280	16P912SM	1-3	179660	8M58SMS1	1-5
173745	16EM1318	1-4	175300	8P24IN	1-3	179670	8M912SMS1	1-5
173770	20M58SM	1-5	175310	8P58IN	1-3	179690	12M24SMS1	1-5
173780	20M912SM	1-5	175320	12P4IN	1-3	179700	12M58SMS1	1-5
173790	24M4SM	1-5	175590	PW2	5-10	179720	EM24S1	5-11
173800	24M58SM	1-5	175600	PW2M6TIIN	5-18	179730	EM58S1	5-11
173810	24M912SM	1-5	175610	PW2M8TIIN	5-18	179740	EM912S1	5-11
173830	32M24SM	1-5	175620	PW2M10TIIN	5-18	179750	EM24SS1	5-12
173840	32M58SM	1-5	175760	EM912SP25	5-11	179760	EM58SMS1	5-12
174560	ESC4	11-41	176690	24M24SM	1-5	179770	EM912SS1	5-12
174800	M6TI	5-26	176710	4G16WN	2-6	179780	8EM24S1	1-4
174801	4QTI	5-26	176830	CJ6	3-2	179790	8EM58S1	1-4
174810	M6TI4	5-15	176870	SLD2Y500	7-28	179800	8EM912S1	1-4
174820	M6TI24	5-15	176880	4G16M25	2-6	179820	12EM58S1	1-4
174830	M6TI58	5-15	177130	812M	1-19	179830	12EM912S1	1-4
174840	M6TI912	5-15	177190	812MATA	2-2	179850	VF14	5-10
174841	4QTI24	5-16	177200	812MATS	2-3	179860	AF14	5-9
174842	4QTI4	5-16	178510	2H4CT	1-13	179900	8MS1	1-19
174843	4QTI58	5-16	178520	4H24CT	1-13	179910	12MS1	1-19
174844	4QTI912	5-16	178530	4H58CT	1-13	179920	TDH	5-19
174850	M6TIB	5-27	178540	4H912CT	1-13	179930	TDHM6	5-20
174870	J1M6TI	5-17	178545	4H1318CT	1-13	179940	TDHM8	5-20
174880	J2M6TI	5-17	178590	4G16M7	2-6	179950	TDHM10	5-20
174881	J1M6QTI	5-17	178600	4G16M11	2-6	179965	MSF	3-2
174882	J2M6QTI	5-17	178620	4G16M11WH	2-6	180811	CAT16HPGBSF	4-8
174890	122M6TI	5-16	178860	4J15M	2-8	180821	CAT32HPGBSF	4-8
174900	M8TI4	5-15	179231	EZR0250	9-29	181001	CAT16HP58	4-6
174910	M8TI24	5-15	179232	EZR0300	9-29	181002	CAT32HP58	4-6
174920	M8TI58	5-15	179233	EZR0350	9-29	181003	CAT64HP58	4-6
174930	M8TI912	5-15	179234	EZR0400	9-29	181006	CAT64HP912	4-6
174940	M8TIB	5-27	179236	EZR0600	9-29	181008	CAT32HP6Z34	4-7
174960	J1M8TI	5-17	179398	4010050EG	9-2	181021	CAT64HPBCB	4-4
174970	J2M8TI	5-17	179399	4010075EG	9-2	181024	CAT64HPAB	4-9
174980	122M8TI	5-16	179400	4100100EG	9-3	181061	CAT16HP	4-2
174990	M10TI4	5-15	179401	4100125EG	9-3	181062	CAT32HP	4-2
175000	M10TI24	5-15	179402	4100150EG	9-3	181063	CAT48HP	4-2
175010	M10TI58	5-15	179403	4100200EG	9-3	181064	CAT64HP	4-2
175020	M10TI912	5-15	179404	4100250EG	9-3	181065	CATHPAN	4-14
175030	M10TIB	5-27	179405	4100300EG	9-3	181066	CATHPA4	4-14
175050	J1M10TI	5-17	179406	4100400EG	9-3	181067	CATHPA6	4-14

E. Index – Article Number / Part Number

Article Number	Part Number	Page	Article Number	Part Number	Page	Article Number	Part Number	Page
181068	CATHPS4	4-15	182031	UTS150	1-29	187600	47SC1924	1-10
181069	CATHPTM	4-15	182032	UTS200	1-29	187610	24SC1924	1-10
181071	CATHP58	4-12	182033	UTS300	1-29	187620	47SC2530	1-10
181072	CATHP912	4-12	182044	PKM10H3	4-21	187630	24SC2530	1-10
181073	CATHPBCB	4-11	182045	PKM10H6	4-21	187640	812SC67	1-10
181078	CATHPBC	4-11	182046	PKM16H3	4-21	187650	812SC89	1-10
181079	CATHPBC200	4-10	182047	PKM16H6	4-21	187660	812SC1011	1-10
181081	CATHPVF14	4-12	182048	PKM10H6IN	4-20	187670	812SC1214	1-10
181082	CATHPESC	4-13	182049	PKM16H6IN	4-20	187680	812SC1518	1-10
181083	CATHP4Z34	4-13	182051	PKMINsert	4-21	187690	812SC1924	1-10
181084	CATHP6Z34	4-13	182052	IGBSF	4-22	187700	812SC2530	1-10
181086	CATHPCD1B	4-14	182053	PKM10H3GBSF	4-22	187710	24SC78	1-10
181088	CATHPCD2.5B	4-14	182054	PKM16H3GBSF	4-22	187720	47SC78	1-10
181089	CAT16HPTS	4-10	182058	QSC	4-19	187730	812SC78	1-10
181091	CATHP24	4-12	182059	QSC4	4-19	187740	HSC78	1-7
181093	CATHPPLR	4-16	182220	BC200CD1B	1-2	187750	24SC910	1-10
181098	CAT16HP24SM	4-5	182230	BC200CD2B	1-2	187760	47SC910	1-10
181099	CAT32HP24SM	4-5	182365	RPSE1H24	8-13	187770	812SC910	1-10
181130	CAT425	4-17	182370	RPSE1H57	8-13	187780	HSC910	1-7
181151	CAT16HP58SM	4-5	182375	RPSE2H46	8-13	187781	SCSOL1A	1-9
181157	CAT48HP58SM	4-5	182380	RPSE4H46	8-13	188080	SCB312	1-11
181161	CAT64HP58SM	4-5	182450	PPRPS25H4	8-16	188090	SCB1220	1-11
181180	BC200M6	5-3	186000	HSC67	1-7	188100	MLT2HS6	5-42
181188	CAT21HP	4-2	186010	HSC89	1-7	188170	SCD1217	1-11
181189	CAT21HPAB	4-9	186020	HSC1011	1-7	188175	SCD1217QSC	1-16
181190	CD1B	1-20	186030	HSC1214	1-7	188180	SCD1722	1-11
181197	CAT21HP24SM	4-5	186040	HSC1518	1-7	188185	SCD1722QSC	1-16
181198	CAT21HP58SM	4-5	186050	HSC1924	1-7	188470	ESG1	3-5
181201	CAT16HPBC	4-3	186060	HSC2532	1-7	188480	MSP20	3-5
181202	CAT32HPBC	4-3	187189	BARRNOG	3-4	188740	HW6M	5-24
181203	CAT48HPBC	4-3	187190	TSGB16	3-4	188780	HW8M	5-24
181209	CAT16HPAB	4-9	187191	TSGB24	3-4	188820	HW10SR	5-24
181211	CAT32HPAB	4-9	187197	SMS8	3-5	188850	PHW8	5-24
181212	CAT48HPAB	4-9	187199	TSGB1624	3-4	190330	VAFT	5-11
181213	CAT16HP24	4-6	187270	HW6	5-24	190490	UBH350M8	5-5
181214	CAT32HP24	4-6	187280	HW8	5-24	190500	UBH500M8	5-5
181215	CAT48HP24	4-6	187290	HW10	5-24	190510	UBHT350	5-5
181216	CAT64HP24	4-6	187300	HW12	5-24	190520	UBHT500	5-5
181217	CAT16HP4Z34	4-7	187310	VKM6	5-38	190620	UBHBTC	5-5
181218	CAT32HP4Z34	4-7	187320	VKM8	5-38	190800	ISSP	11-38
181219	CAT16HPBCB	4-4	187330	VKM10	5-38	191003	24SC1518R25	1-10
181221	CAT32HPBCB	4-4	187370	LR1	1-9	191004	24SC1924R25	1-10
181222	CAT48HPBCB	4-4	187380	LR2	1-9	191005	24SC2530R25	1-10
181231	CAT48HP58	4-6	187390	LB3B	1-8	191009	47SC1518R25	1-10
181232	CAT48HP912	4-6	187400	LF2	1-8	191010	47SC1924R25	1-10
181238	CAT21HPBC	4-3	187410	LF3	1-8	191011	47SC2530R25	1-10
181245	CAT21HPBCB	4-4	187430	LF5	1-8	191015	812SC1518R25	1-10
181258	CAT21HP4Z34	4-7	187440	HK25	1-7	191016	812SC1924R25	1-10
181271	RET16B50	4-16	187450	HK48	1-7	191017	812SC2530R25	1-10
181272	RET21B50	4-16	187460	HK811	1-7	191018	4H24R5	5-13
181273	RET32B50	4-16	187500	47SC67	1-10	191019	4H58R5	5-13
181274	RET48B25	4-16	187510	24SC67	1-10	191021	4H24CTR5	1-13
181275	RET64B25	4-16	187520	47SC89	1-10	191022	4H58CTR5	1-13
181580	STCB10M	11-31	187530	24SC89	1-10	191023	4H912CTR5	1-13
181880	CAT425WM	4-18	187540	47SC1011	1-10	191024	M6T124R5	5-15
181976	CAT100CM	4-17	187550	24SC1011	1-10	191026	EM24R5	5-11
181995	CATMTLS	4-19	187560	47SC1214	1-10	191027	EM58R5	5-11
181996	WCTM	1-28	187570	24SC1214	1-10	191044	EM58SM16R5	5-12
182015	WBS1	1-30	187580	47SC1518	1-10	191045	4H912R5	5-13
182019	WBS2	1-29	187590	24SC1518	1-10	195851	SLADCP	7-32

E. Index – Article Number / Part Number

Article Number	Part Number	Page	Article Number	Part Number	Page	Article Number	Part Number	Page
195852	SLADS	7-32	196532	SLK2L3DH	7-12	196700	SLK3L1	7-14
195853	SLWC	7-31	196533	SLK2L5DH	7-12	196701	SLK3L2	7-14
195853	SLWC	10-18	196534	SLK2L7DH	7-12	196702	SLK3L3	7-14
195854	SLEBM6	7-33	196535	SLK2L34H24	7-13	196703	SLK3L5	7-14
195856	SLEBM8	7-33	196536	SLK2L34H58	7-13	196704	SLK3L7	7-14
195858	SLEBWS	7-33	196537	SLK2L1	7-14	196705	SLK3L10	7-14
195860	SL1214	7-34	196538	SLK2L2	7-14	196706	SLK3L1LP	7-15
195861	SL1518	7-34	196539	SLK2L3	7-14	196707	SLK3L2LP	7-15
195864	CFEB05	7-33	196540	SLK2L5	7-14	196708	SLK3L3LP	7-15
195935	SLD15L2S	7-26	196541	SLK2L7	7-14	196709	SLK3L5LP	7-15
195940	SLD15L5S	7-26	196542	SLK2L10	7-14	196711	SLK3L10LP	7-15
195945	SLD15L10S	7-26	196543	SLK2L2LP	7-15	196713	SLK3L2AB	7-9
195960	SLD15Y500	7-28	196544	SLK2L3LP	7-15	196715	SLK3L5AB	7-9
195998	SLD3YH800	7-27	196545	SLK2L5LP	7-15	196716	SLK3L10AB	7-9
196001	SLC15L1000SP	7-31	196546	SLK2L2SF	7-10	196721	SLK3L10SEM10	7-16
196002	SLC2L1000SP	7-31	196547	SLK2L3SF	7-10	196722	SLK3L1WA6	7-17
196003	SLC3L1000SP	7-31	196548	SLK2L5SF	7-10	196723	SLK3L2WA6	7-17
196007	SLD15QT250	7-28	196549	SLK2YH500L2	7-19	196725	SLK3L5WA6	7-17
196008	SLJR200	7-31	196550	SLK2YH500L3	7-19	196726	SLK3L7WA6	7-17
196015	SLD2YH500	7-27	196551	SLK2YH500L7	7-19	196727	SLK3L10WA6	7-17
196022	SLC2L100SP	7-31	196554	SLK2Y500L3	7-20	196728	SLK3L7AB	7-9
196023	SLC15L50MSP	7-31	196556	SLK2Y300L7	7-20	196730	SLK3C200	7-30
196028	SLDM615L1	7-26	196559	SLK2L2SEM8	7-16	196734	SLK2L2WA6	7-17
196029	SLDM615L2	7-26	196560	SLK2L3SEM6	7-16	196735	SLK2L3WA6	7-17
196044	SLDM615L2T	7-27	196561	SLK2L3SEM8	7-16	196736	SLK2L5WA6	7-17
196045	SLK15L500PACK	7-29	196562	SLK2L5SEM6	7-16	196737	SLK2L7WA6	7-17
196046	SLK15L50MPACK	7-29	196563	SLK2L5SEM8	7-16	196739	SLS2C50	7-30
196047	SLK2L100PACK	7-29	196564	SLK15L1SEM6	7-16	196740	SLS3C50	7-30
196048	SLK15PROMOPACK	7-29	196565	SLK15L1SEM8	7-16	196741	SLS2L1	7-22
196500	SLK15L1AB	7-9	196566	SLK15L2SEM6	7-16	196742	SLS2L2	7-22
196501	SLK15L2AB	7-9	196567	SLK15L2SEM8	7-16	196743	SLS2L3	7-22
196502	SLK15L3AB	7-9	196568	SLK15L3SEM6	7-16	196744	SLS2L5	7-22
196503	SLK15L5AB	7-9	196570	SLK15L3SEM8	7-16	196745	SLS2L7	7-22
196504	SLK15L3DH	7-12	196600	SLK2C200	7-30	196746	SLS2L10	7-22
196505	SLK15L5DH	7-12	196601	SLK15L1LP	7-15	196747	SLS3L1	7-22
196506	SLK15L34H24	7-13	196602	SLK15L7LP	7-15	196748	SLS3L2	7-22
196507	SLK15L34H58	7-13	196603	SLK15L10LP	7-15	196749	SLS3L3	7-22
196508	SLK15L1	7-14	196604	SLK2L1LP	7-15	196750	SLS3L5	7-22
196509	SLK15L2	7-14	196605	SLK2L7LP	7-15	196751	SLS3L7	7-22
196510	SLK15L3	7-14	196606	SLK2L10LP	7-15	196752	SLS3L10	7-22
196511	SLK15L5	7-14	196614	SLK15L2R2	7-14	196753	SLS2L3DH	7-21
196512	SLK15L7	7-14	196615	SLK15L3R2	7-14	196754	SLS2L5DH	7-21
196513	SLK15L10	7-14	196616	SLK15L5R2	7-14	196755	SLS2L7DH	7-21
196514	SLK15L2LP	7-15	196619	SLK2L2R2	7-14	196756	SLS2L2SEM8	7-23
196515	SLK15L3LP	7-15	196620	SLK2L3R2	7-14	196757	SLS2L3SEM8	7-23
196516	SLK15L5LP	7-15	196625	SLK3L3R2	7-14	196759	SLS2L3WA6	7-24
196517	SLK15L1SF	7-10	196626	SLK3L5R2	7-14	196760	SLS2L5WA6	7-24
196518	SLK15L2SF	7-10	196628	SLK15L1LPR2	7-15	196761	SLS2L7WA6	7-24
196519	SLK15L3SF	7-10	196629	SLK15L2LPR2	7-15	196800	SLK6L5	7-5
196520	SLK15L5SF	7-10	196630	SLK15L3LPR2	7-15	196801	SLK6L10	7-5
196521	SLK15L1T	7-18	196631	SLK15L5LPR2	7-15	196802	SLK6L15	7-5
196522	SLK15L2T	7-18	196644	SLK15L2TR2	7-18	196803	SLK6L20	7-5
196523	SLK15L3T	7-18	196645	SLK15L3TR2	7-18	196804	SLK6L25	7-5
196524	SLK15L5T	7-18	196648	SLK15Y300L3R2	7-20	196805	SLK6L30	7-5
196525	SLK15L7T	7-18	196670	SLK15L1WA6	7-17	196806	SLK6L40	7-5
196526	SLK15L10T	7-18	196671	SLK15L2WA6	7-17	196807	SLK6L50	7-5
196528	SLK15Y500L3	7-20	196672	SLK15L3WA6	7-17	196819	SLC6CTO	7-6
196529	SLK2L2AB	7-9	196673	SLK15L5WA6	7-17	196820	SLK6C2	7-6
196530	SLK2L3AB	7-9	196676	SLK15L1DH	7-12	196821	SLC6L50	7-6
196531	SLK2L5AB	7-9	196677	SLK15L2DH	7-12	196822	SLDW6	7-6

E. Index – Article Number / Part Number

Article Number	Part Number	Page	Article Number	Part Number	Page	Article Number	Part Number	Page
196830	SLK15L1DW6	7-7	311401	KAA25H0300HD	11-15	313070	ZE107	11-19
196831	SLK15L2DW6	7-7	311419	KAA25H0500HD	11-15	313080	ZE108	11-20
196832	SLK15L3DW6	7-7	311431	KAA25H0750HD	11-15	313120	ZU400	11-38
196833	SLK15L5DW6	7-7	311451	KAA25H1050HD	11-15	313260	ZT605HD	11-29
196834	SLK15L7DW6	7-7	311649	KC25H0150HD	11-15	313270	ZT606HDEG	11-30
196835	SLK15L10DW6	7-7	311657	KC25H0150EG	11-15	313280	ZT607	11-30
196836	SLK2L1DW6	7-7	311659	KC25H0300HD	11-15	313301	ADKE0L	11-44
196837	SLK2L2DW6	7-7	311667	KC25H0300EG	11-15	313302	ADKE0	11-44
196838	SLK2L3DW6	7-7	311669	KC25H0450HD	11-15	313303	ADKE4	11-44
196839	SLK2L5DW6	7-7	311677	KC25H0450EG	11-15	313304	ADKE2	11-44
196840	SLK2L7DW6	7-7	311693	KA25H0150S6	11-14	313305	ADK421	11-7
196841	SLK2L10DW6	7-7	311694	KA25H0300S6	11-14	313310	CL3000PS	11-7
196842	SLK3L1DW6	7-7	311695	KA25H0450S6	11-14	313330	ZW200	11-21
196843	SLK3L2DW6	7-7	311696	KA25H0600S6	11-14	313340	ZW201	11-21
196844	SLK3L3DW6	7-7	311702	KA25H0150HD	11-14	313350	ZW202	11-23
196845	SLK3L5DW6	7-7	311703	KA25H0200HD	11-14	313380	ZW205	11-25
196846	SLK3L7DW6	7-7	311707	KA25H0150EG	11-14	313400	ZW207	11-26
196847	SLK3L10DW6	7-7	311708	KA25H0200EG	11-14	313640	ZW219A45	11-22
196850	SL6T	7-8	311713	KA25H0300HD	11-14	313700	ZW220	11-26
196852	SLBM12	7-8	311717	KA25H0300EG	11-14	313821	ZGA505	11-35
196855	196855	7-8	311718	KA25H0450HD	11-14	313822	ZGA506	11-33
197812	SLK15L2GBSF	7-11	311728	KA25H0450EG	11-14	313823	ZGA507	11-34
197813	SLK15L3GBSF	7-11	311729	KA25H0500EG	11-14	313824	ZGA508	11-33
197814	SLK2L2GBSF	7-11	311731	KA25H0600EG	11-14	313825	ZGA509	11-32
197815	SLK2L3GBSF	7-11	311732	KA25H0500HD	11-14	313826	ZGA510	11-33
310061	CC25H3000PG	11-5	311733	KA25H0600HD	11-14	313828	ZGA512	11-34
310071	CC25H6000PG	11-5	311756	KA25H0750EG	11-14	313850	ZZ702	11-28
310111	CC25H6000HD	11-5	311757	KA25H0750HD	11-14	313870	ZZ704HDEG	11-30
310181	AA25H3000PG	11-3	311758	KA25H1000HD	11-14	314995	NUTM6EG	11-9
310191	AA25H6000PG	11-3	311759	KA25H1200HD	11-14	315000	NUTM6HD	11-9
310221	AA25H3000HD	11-3	311760	KA25H1500HD	11-14	315010	NUTM8HD	11-9
310231	AA25H6000HD	11-3	311761	KA25H2000HD	11-14	315015	NUTM8EG	11-9
310241	C25H3000PG	11-4	311805	KCC25H0300HD	11-16	315020	NUTM10HD	11-9
310255	C25H6000PG	11-4	311815	KCC25H0450HD	11-16	315025	NUTM10EG	11-9
310256	C20L2000PG	11-4	311825	KCC25H0600HD	11-16	315030	NUTM12HD	11-9
310257	C20L3000PG	11-4	311840	ZWA223	11-27	315031	NUTM12THD	11-9
310265	C25H6000S6	11-4	311842	ZWA225	11-27	315035	NUTM12EG	11-9
310281	C25H3000HD	11-4	311900	SNAHD	11-36	315036	NUTM16EG	11-9
310283	C25H4000PG	11-4	311905	SNAEG	11-36	315037	NUTM16HD	11-9
310291	C25H6000HD	11-4	311920	CTRI120HD	11-16	315040	SPRCM6HD	11-11
310293	A20L2000PG	11-2	311925	CTRI160HD	11-16	315045	SPRCM6EG	11-11
310299	A25H3000PG	11-2	311930	CTRI210HD	11-16	315050	SPRCM8HD	11-11
310303	A20L3000PG	11-2	311935	CTRI260HD	11-16	315055	SPRCM8EG	11-11
310311	A25H6000PG	11-2	311940	CTRI310HD	11-16	315060	SPRCM10HD	11-11
310313	A20L6000PG	11-2	311945	CTRI410HD	11-16	315065	SPRCM10EG	11-11
310322	A25H2000S6	11-2	311950	CTRI510HD	11-16	315070	SPRCM12HD	11-11
310326	A25H6000S6	11-2	311955	CTRI810HD	11-16	315075	SPRCM12EG	11-11
310333	A25H4000PG	11-2	312110	CUCS0250HD	11-57	315080	SPRAM6HD	11-10
310339	A25H3000HD	11-2	312120	CUCS0300HD	11-57	315085	SPRAM6EG	11-10
310358	A25H6000HD	11-2	312140	CUCS0400HD	11-57	315090	SPRAM8HD	11-10
310360	A25S3000PG	11-3	312160	CUCS0500HD	11-57	315095	SPRAM8EG	11-10
310370	A25S6000PG	11-3	312170	CUCS0600HD	11-57	315100	SPRAM10HD	11-10
310400	A25S3000HD	11-3	312180	CUCS0800HD	11-57	315105	SPRAM10EG	11-10
310410	A25S6000HD	11-3	312190	CUCS1000HD	11-57	315110	SPRAM12HD	11-10
310600	E12H1000PG	11-6	312195	CUCS1300HD	11-57	315115	SPRAM12EG	11-10
310605	E25H6000PG	11-6	312198	SCT03	5-26	315120	SPRAM10S6	11-10
310620	EE25H6000PG	11-6	312200	UC202000PG	11-56	315140	NUTM6S6	11-9
310630	D25H3000PG	11-5	313000	ZE100	11-17	315150	NUTM8S6	11-9
310635	D25H6000PG	11-5	313020	ZE102	11-18	315160	NUTM10S6	11-9
310650	DD25H6000PG	11-6	313040	ZE104	11-19	315170	NUTM12S6	11-9

E. Index – Article Number / Part Number

Article Number	Part Number	Page	Article Number	Part Number	Page	Article Number	Part Number	Page
315180	SPRAM6S6	11-10	335570	E530H3000HD	11-43	337140	C70ES	1-23
315190	SPRAM8S6	11-10	335580	E530H6000HD	11-43	337150	C76ES	1-23
315210	SPRCM6S6	11-11	335600	E530H0400S4	11-43	337160	C82ES	1-23
315220	SPRCM8S6	11-11	335620	E530H0600S4	11-43	337300	C12EU	1-22
315230	SPRCM10S6	11-11	335640	E530H1000S4	11-43	337310	C16EU	1-22
315330	E4CNM8	11-47	335650	E530H2000S4	11-43	337320	C20EU	1-22
315340	E01CNM8	11-47	335660	E530H3000S4	11-43	337330	C24EU	1-22
315350	E01CNM10	11-47	335670	E530H6000S4	11-43	337340	C28EU	1-22
315360	E4CNM10	11-47	335980	ISOSTRUT	11-61	337350	C32EU	1-22
315370	E01CNM6	11-47	336000	6300SWHDEG	5-8	337360	C36EU	1-22
315450	STS	11-7	336020	6500SWHDEG	5-8	337370	C40EU	1-22
317096	A15L2000PG	11-2	336030	HB2	5-4	337380	C44EU	1-22
317099	A15L3000PG	11-2	336040	HB2HD	5-4	337390	C48EU	1-22
317111	A15L6000PG	11-2	336050	OSM8X25	5-41	337400	C52EU	1-22
317116	C15L2000PG	11-4	336060	OSM10X30	5-41	337410	C56EU	1-22
317118	C25H2000S6	11-4	336100	C20HD	1-26	337420	C60EU	1-22
317119	C15L3000PG	11-4	336110	C30HD	1-26	337430	C64EU	1-22
317131	C15L6000PG	11-4	336120	C45HD	1-26	337440	C70EU	1-22
317241	A15L3000HD	11-2	336130	C20S4	1-26	337450	C76EU	1-22
317251	A15L6000HD	11-2	336140	C30S4	1-26	337460	C82EU	1-22
330000	6300CCHD	5-7	336150	C45S4	1-26	337600	C12EC	1-21
330010	6400CCHD	5-7	336160	CNM6	1-27	337610	C16EC	1-21
330020	6500CCHD	5-7	336170	CNM8	1-27	337620	C20EC	1-21
330030	6600CCHD	5-7	336180	CNM6S4	1-27	337630	C24EC	1-21
330100	6300AAHD	5-7	336190	CNM8S4	1-27	337640	C28EC	1-21
330110	6400AAHD	5-7	336200	SPPM6HD	1-26	337650	C32EC	1-21
330120	6500AAHD	5-7	336210	SPPM8HD	1-26	337660	C36EC	1-21
330130	6600AAHD	5-7	336220	SPPM6S4	1-26	337670	C40EC	1-21
330140	6800AAHD	5-7	336230	SPPM8S4	1-26	337680	C44EC	1-21
330210	CC25H0400HD	11-5	336280	D1	5-8	337690	C48EC	1-21
330220	CC25H0500HD	11-5	336290	INC8	11-32	337700	C52EC	1-21
330230	CC25H0600HD	11-5	336300	CR037HD	1-25	337710	C56EC	1-21
330390	AA25H0400HD	11-3	336310	CR050HD	1-25	337720	C60EC	1-21
330410	AA25H0600HD	11-3	336320	CR075HD	1-25	337730	C64EC	1-21
330420	AA25H0800HD	11-3	336322	CR087HD	1-25	337740	C70EC	1-21
330430	AA25H1000HD	11-3	336330	CR100HD	1-25	337750	C76EC	1-21
330440	AA25H2000HD	11-3	336340	CR125HD	1-25	337760	C82EC	1-21
330600	6120HD	11-31	336350	CR150HD	1-25	337770	C88EC	1-21
330610	6120S4	11-31	336360	CR200HD	1-25	337780	C94EC	1-21
335000	5300HD	5-7	336400	CR037S4	1-25	337790	C100EC	1-21
335010	5400HD	5-7	336410	CR050S4	1-25	337800	C12GW	1-24
335020	5500HD	5-7	336420	CR075S4	1-25	337810	C16GW	1-24
335030	5600HD	5-7	336430	CR100S4	1-25	337820	C20GW	1-24
335060	5400S4	5-7	336440	CR125S4	1-25	337830	C24GW	1-24
335080	5600S4	5-7	336450	CR150S4	1-25	337840	C28GW	1-24
335100	5120HD	11-54	336460	CR200S4	1-25	337850	C32GW	1-24
335150	5190HD	11-48	337000	C12ES	1-23	337860	C36GW	1-24
335160	5190S6	11-48	337010	C16ES	1-23	337870	C40GW	1-24
335170	E5CN6HD	11-48	337020	C20ES	1-23	337890	C48GW	1-24
335180	E5CN8HD	11-48	337030	C24ES	1-23	339500	C12LW	1-24
335190	E5CN10HD	11-48	337040	C28ES	1-23	339510	C16LW	1-24
335200	E5CN6S4	11-48	337050	C32ES	1-23	350000	350000	5-13
335210	E5CN8S4	11-48	337060	C36ES	1-23	350100	FXB20S2	9-52
335500	E530H0300HD	11-43	337070	C40ES	1-23	350110	FXB21S2	9-53
335510	E530H0400HD	11-43	337080	C44ES	1-23	350120	FXB22S2	9-53
335520	E530H0500HD	11-43	337090	C48ES	1-23	350130	FXB23S2	9-53
335530	E530H0600HD	11-43	337100	C52ES	1-23	350140	FXB24S2	9-54
335540	E530H0800HD	11-43	337110	C56ES	1-23	350150	FXB25S2	9-54
335550	E530H1000HD	11-43	337120	C60ES	1-23	360420	PHK	8-8
335560	E530H2000HD	11-43	337130	C64ES	1-23	360421	PHKR	8-8

E. Index – Article Number / Part Number

Article Number	Part Number	Page	Article Number	Part Number	Page	Article Number	Part Number	Page
360422	PHB	8-8	387500	ZEA100	11-17	388370	ZGA503	11-32
360423	PHBR	8-8	387510	ZEA101	11-17	388380	ZGA504	11-32
360424	HFRMHDW	8-9	387520	ZEA102	11-18	388390	ZZA700	11-27
360425	PEB	8-11	387522	ZEA102S6	11-18	388421	ZZA705	11-28
360426	PEK4B	8-9	387530	ZEA103	11-18	388422	ZZA706	11-27
360427	PEK6B	8-10	387532	ZEA103S6	11-18	388670	ZWA200S6	11-21
360428	PEC	8-12	387540	ZEA104	11-19	388701	ZEA108S6	11-20
360460	PTF6	8-14	387542	ZEA104S6	11-19	388710	ZEA100S6	11-17
360461	PTF10	8-14	387550	ZEA105	11-20	388761	ZWA205S6	11-25
360462	PTF16	8-14	387560	ZEA106	11-18	388890	310M12	5-2
360463	PSF6C	8-4	387570	ZEA107	11-19	388901	ZAA180	11-37
360464	PSF10C	8-4	387572	ZEA107S6	11-19	388906	ZRA180	11-37
360465	PSF10D	8-4	387580	ZEA108	11-20	389001	389001	9-33
360466	PSF16C	8-4	387590	ZEA109	11-21	389002	389002	9-33
360467	PSF16D	8-4	387600	ZWA200	11-21	389003	389003	9-33
360468	PSA10CH13	8-5	387610	ZWA201	11-21	389004	389004	9-33
360469	PSA16AH18	8-5	387620	ZWA202	11-23	389005	389005	9-33
360470	PRF2	8-6	387625	ZWA202S6	11-23	389006	389006	9-33
360472	PRF6	8-6	387630	ZWA203	11-22	389007	389007	9-33
360474	PRA6H16	8-7	387640	ZWA204	11-22	389008	389008	9-33
360475	PSB24A	8-5	387650	ZWA205	11-25	389009	389009	9-33
360476	PSB30A	8-5	387660	ZWA206	11-24	389011	389011	9-33
360477	PSB36A	8-5	387670	ZWA207	11-26	389013	389013	9-33
360478	PSB42A	8-5	387675	ZWA207L	11-26	389017	389017	9-33
360479	PSB48A	8-5	387690	ZWA209	11-25	389018	389018	9-33
360480	PSB60A	8-5	387701	ZTA601HD	11-29	389051	389051	9-34
360483	PRS6	8-7	387710	ZTA601S6	11-29	389052	389052	9-34
360484	PTF1C	8-14	387720	ZZA702	11-28	389500	30009MM	5-2
360485	PTF2C	8-14	387730	ZSA300	11-40	389505	30017MM	5-2
360493	PEKEF	8-10	387740	ZSA301	11-39	389510	30011MM	5-2
360494	PEH31	8-11	387742	ZSA301S6	11-39	389520	30013MM	5-2
360495	PBU6M	8-13	387750	ZUA400	11-38	389890	310M10	5-2
360496	PBU10M	8-13	387760	ZUA401	11-39	390001	CRLBM8EG	6-5
360497	PBU16M	8-13	387770	ZUA402	11-38	390002	CRLBM10EG	6-5
360518	PTF6P	8-15	387780	ZUA403	11-39	390003	CRLSM8EG	6-10
360519	PTF10P	8-15	387790	ZUA404	11-36	390004	CRLSM10EG	6-10
360521	PTFP	8-15	387800	ZUA405	11-36	390005	SNM6	6-10
360522	PTF16P	8-15	387805	ZU405PG	11-36	390006	SNM8	6-10
366593	TSR1220N	11-59	387810	ZUA406	11-35	390007	SNM10	6-10
366594	TSR1220R	11-59	387820	ZUA407	11-35	390008	SNM12	6-10
366595	TSR1220SLS3	7-25	387830	ZUA408	11-36	390009	CRLAM8EG	6-6
380050	KN30EG	2-4	387850	ZWA218A45	11-22	390010	CRLAM10EG	6-6
380060	KN40EG	2-4	387870	ZWA212	11-25	390012	CRLLM10EG	6-7
380070	KN50EG	2-4	387880	ZWA213	11-26	390029	CRLP1M8L550	6-8
385505	A25H2000PG	11-2	387890	ZWA214	11-24	390030	CRLP1M8L750	6-8
385860	CHK22K	2-3	387900	ZWA215	11-24	390035	CRLP1M10L550	6-8
385870	CHK25K	2-3	387910	ZWA216	11-23	390036	CRLP1M10L750	6-8
385880	CHK27K	2-3	387920	ZWA219A45	11-22	390037	CRLP2M10L550	6-8
385890	CHK30K	2-3	387930	ZWA217	11-23	390038	CRLP2M10L750	6-8
385900	CHK32K	2-3	387960	ZSA302	11-40	390039	CRLP2M10L950	6-8
385910	CHN15K	2-3	387970	ZSA303	11-40	390040	CRLP2M10L1050	6-8
385920	CHN17K	2-3	387975	ZB11MM35X35	5-29	390101	SNSWM8	6-11
386780	CHN13K	2-3	387976	AB11MM35X35	5-28	390102	SNSWM10	6-11
386805	300M6	5-2	387980	ZWA220	11-26	390105	TSR3050M8RL	6-9
386810	300M8	5-2	388006	ZTA602HD	11-29	390106	TSR3050M10RL	6-9
386820	300M10	5-2	388066	ZTA603HD	11-29	400046	CE4SBEG	11-52
386830	300M12	5-2	388080	ZTA605	11-29	400047	CE4SCEG	11-51
387190	ZTA605S6	11-29	388270	ZGA501	11-35	400055	SXE014	9-15
387365	C25H2000PG	11-4	388350	6000HBEG	11-37	400056	SXE019	9-15
387450	ZEA110	11-20	388360	ZGA502	11-34	400057	SXE023	9-15

E. Index – Article Number / Part Number

Article Number	Part Number	Page	Article Number	Part Number	Page	Article Number	Part Number	Page
400058	SXE028	9-15	400188	DIN406PL	9-20	400660	MDS019	9-19
400059	SXE035	9-15	400190	DIN457PL	9-20	400661	MDS023	9-19
400060	SXE043	9-15	400191	DIN508PL	9-20	400662	MDS028	9-19
400061	SXE049	9-15	400193	DIN610PL	9-20	400663	MDS035	9-19
400062	SXE052	9-15	400197	DIN021HD	9-20	400664	MDS043	9-19
400063	SXD014	9-16	400199	DIN027HD	9-20	400676	DPS025	9-36
400064	SXD019	9-16	400201	DIN034HD	9-20	400678	008017EG	9-35
400065	SXD023	9-16	400203	DIN042HD	9-20	400679	008021EG	9-35
400066	SXD028	9-16	400205	DIN048HD	9-20	400680	008027EG	9-35
400067	SXD035	9-16	400208	DIN060HD	9-20	400681	008034EG	9-35
400068	SXD043	9-16	400210	DIN076HD	9-20	400682	008042EG	9-35
400069	SXD049	9-16	400212	DIN089HD	9-20	400683	008048EG	9-35
400070	SXD052	9-16	400214	DIN102HD	9-20	400684	008060EG	9-35
400071	SXD061	9-16	400216	DIN114HD	9-20	400810	RADTOP260EG	9-44
400072	SXD067	9-16	400219	DIN140HD	9-20	400812	RADTOP300EG	9-44
400073	SXD073	9-16	400222	DIN168HD	9-20	400813	RADTOP330EG	9-44
400074	SXD080	9-16	400225	DIN219HD	9-20	400816	RADTOPWS	9-44
400075	SXD091	9-16	400229	DIN273HD	9-20	400914	ISOE01	11-61
400076	SXD106	9-16	400233	DIN323HD	9-20	400916	MPE4	11-55
400077	SXD114	9-16	400234	DIN355HD	9-20	401121	VDFTM8	5-35
400078	MPD014	9-12	400236	DIN406HD	9-20	401122	VDFTM10	5-35
400079	MPD019	9-12	400238	DIN457HD	9-20	401126	LLSM8X30	5-40
400080	MPD023	9-12	400239	DIN508HD	9-20	401129	LLSH6X30	5-40
400081	MPD028	9-12	400241	DIN610HD	9-20	401145	025DM8S4	5-33
400082	MPD035	9-12	400313	UPH0050PL	9-36	401146	025DM10S4	5-33
400083	MPD043	9-12	400314	UPH0075PL	9-36	401150	SABM8010S6	5-43
400084	MPD049	9-12	400320	UPH0050EG	9-36	401151	SABM8050S6	5-43
400085	MPD056	9-12	400321	UPH0075EG	9-36	401152	SABM10010S6	5-43
400086	MPD061	9-12	400332	050M161000	5-31	401153	SABM10050S6	5-43
400087	MPD067	9-12	400336	051M8025	5-30	401154	CAM8030S6	5-47
400088	MPD073	9-12	400337	051M8040	5-30	401155	CAM10040S6	5-47
400089	MPD080	9-12	400338	051M8060	5-30	401158	SABM12050	5-43
400090	MPD091	9-12	400340	051M8080	5-30	401161	MXOVDN1012EG	9-29
400091	MPD106	9-12	400342	051M8100	5-30	401244	MXOVDN1215EG	9-29
400092	MPD114	9-12	400345	051M10025	5-30	401245	MXOVDN1618EG	9-29
400093	MPD116	9-12	400346	051M10040	5-30	401246	MXOVDN20EG	9-29
400094	MPD127	9-12	400347	051M10060	5-30	401903	MPK028	9-13
400095	MPD135	9-12	400349	051M10080	5-30	401904	MPK035	9-13
400096	MPD139	9-12	400351	051M10100	5-30	401905	MPK043	9-13
400097	MPD144	9-12	400355	051M12040	5-30	401906	MPK049	9-13
400098	MPD163	9-12	400403	VDFM12120	5-36	401907	MPK056	9-13
400099	MPD169	9-12	400405	042H8065	5-35	401908	MPK061	9-13
400100	MPD200	9-12	400408	SABM8010	5-43	401911	MPK080	9-13
400101	MPD212	9-12	400409	SABM8050	5-43	401912	MPK091	9-13
400149	DIN021PL	9-20	400410	SABM10010	5-43	401914	MPK114	9-13
400151	DIN027PL	9-20	400411	SABM10050	5-43	401918	MPK139	9-13
400153	DIN034PL	9-20	400415	CAM12050	5-47	401920	MPK163	9-13
400155	DIN042PL	9-20	400420	TCAM12050	5-48	401921	MPK169	9-13
400157	DIN048PL	9-20	400421	TCAM16065	5-48	401922	MPK200	9-13
400160	DIN060PL	9-20	400426	NAIL04X14	5-41	402170	SABM12015	5-43
400162	DIN076PL	9-20	400427	NAIL04X18	5-41	402171	SABM16025	5-43
400164	DIN089PL	9-20	400428	NAILTOOL	5-41	402190	CSB12CBL	10-16
400166	DIN102PL	9-20	400429	SBP17	9-50	402191	CSB18CBL	10-16
400168	DIN114PL	9-20	400430	SBPC19	9-51	402192	CSB36CBL	10-16
400171	DIN140PL	9-20	400444	010M16	5-37	402194	CSB12SLVB	10-16
400174	DIN168PL	9-20	400448	01116EG	5-38	402195	CSB18SLVB	10-16
400177	DIN219PL	9-20	400477	VDFM8050S4	5-36	402196	CSB36SLVB	10-16
400181	DIN273PL	9-20	400478	VDFM8080S4	5-36	402198	CSBURC38	10-17
400185	DIN323PL	9-20	400482	VDFM10100S4	5-36	402199	CSBURC12	10-17
400186	DIN355PL	9-20	400659	MDS015	9-19	402200	CSBURC58	10-17

E. Index – Article Number / Part Number

Article Number	Part Number	Page	Article Number	Part Number	Page	Article Number	Part Number	Page
402201	CSBURCR38	10-17	403715	MXZ184	9-27	570580	3003EG	11-57
402202	CSBURCR12	10-17	403720	MXZ195	9-27	570590	3004EG	11-57
402203	CSBURCR58	10-17	403730	MXZ218	9-27	570710	FPN6	5-52
402207	CSBRS1	10-22	403800	MXOVDN25EG	9-29	570720	FPN8	5-52
402208	CSBNPC12	10-18	404300	CSBT1	10-15	570730	FPN10	5-52
402209	CSB3346SB	10-19	404301	CSBT2	10-15	570740	FPN12	5-52
402239	CSBBRS1MEG	10-20	404350	CSBBC075EG	10-6	570800	NPN640	5-51
402240	CSBBRS2MEG	10-21	404354	CSBBARJEG	10-4	570810	NPN660	5-51
402241	CSBBRS3MEG	10-21	404365	CSBIB075085EG	10-5	570820	NPN680	5-51
402268	VS200000	9-58	404366	CSBIB075145EG	10-5	570830	NPN860	5-51
402446	SABM20030	5-43	404367	CSBIB125180EG	10-5	571130	FRF014	9-34
402500	CSBIBSN37EG	10-9	404371	CSBMA050050EG	10-7	571140	FRF016	9-34
402501	CSBIBSB50EG	10-8	404372	CSBMA050075EG	10-7	571150	FRF018	9-34
402502	CSBBARJSB50EG	10-8	404373	CSBQIKCL0100EG	10-12	571160	FRF020	9-34
402503	CSBUNIVSB62EG	10-8	404374	CSBQIKCL0125EG	10-12	571170	FRF022	9-34
402505	CSBQIKCLSN37EG	10-9	404375	CSBQIKCL0150EG	10-12	571180	FRF025	9-34
402510	CSB12CBLSS	10-16	404376	CSBQIKCL0200EG	10-12	571190	FRF028	9-34
402511	CSB18CBLSS	10-16	404385	CSBSTU0100EG	10-10	571200	FRF016X2	9-35
402512	CSB36CBLSS	10-16	404386	CSBSTU0125EG	10-10	571210	FRF018X2	9-35
402514	CSB12SLVBSS	10-16	404387	CSBSTU0150EG	10-10	571220	FRF020X2	9-35
402515	CSB18SLVBSS	10-16	404388	CSBSTU0200EG	10-10	571230	FRF022X2	9-35
402516	CSB36SLVBSS	10-16	404389	CSBSTU0250EG	10-10	571240	FRF025X2	9-35
402522	CSBURC38SS	10-17	404390	CSBSTU0300EG	10-10	571250	FRF028X2	9-35
402523	CSBURC12SS	10-17	404391	CSBSTU0400EG	10-10	571270	PWM	5-52
402528	CSBNPC38	10-18	404392	CSBSTU0500EG	10-10	571280	PWMS	5-52
402529	CSBNPC58	10-18	404393	CSBSTU0600EG	10-10	571290	PWN	5-52
402536	CSBC48	10-18	404394	CSBSTU0800EG	10-10	571300	PWNS	5-52
402564	CSBURC58SS	10-17	404395	CSBSTU1000EG	10-10	571460	MFV433	5-49
402601	N6T5X10L49	5-46	404407	CSBUNIV050EG	10-8	571470	MFV537	5-49
402605	BSZSU06040ZL	5-44	404409	CSBUNIV075EG	10-8	571510	MFV650	5-49
402606	BSZSU06050ZL	5-44	404461	CSB12SBHS	10-19	571520	MFT1	5-50
402610	BSZSU08070ZL	5-44	404463	CSBSH00375EG	10-7	571530	MFT2	5-50
402615	BSZSU10100ZL	5-44	404464	CSBSH00500EG	10-7	574170	STRC012CU	9-30
402620	BSZSU10120ZL	5-44	404465	CSBSH00625EG	10-7	574180	STRC015CU	9-30
402625	BSZSU12110ZL	5-44	404466	CSBSH00750EG	10-7	574190	STRC018CU	9-30
402655	SZB12010EG	5-45	404467	CSBRS37EG	10-22	574200	STRC022CU	9-30
402660	SZB12030EG	5-45	404469	CSBQG0300EG	10-14	574210	STRC028CU	9-30
402665	SZB15015EG	5-45	404470	CSBQG0400EG	10-14	574250	EYESM6EG	5-40
402670	SZB18010EG	5-45	404472	CSBQG0600EG	10-14	574260	EYESM8EG	5-40
402675	SZB18020EG	5-45	404473	CSBQG0800EG	10-14	574270	EYESM10EG	5-40
402690	BSZM6X35EG	5-45	404475	CSBQG0250MEG	10-14	574310	EYEBH5065EG	5-39
403600	MXZ018	9-27	404477	CSBBRP0100EG	10-20	574320	EYEBH6075EG	5-39
403605	MXZ026	9-27	404478	CSBBRP0125EG	10-20	574340	EYEBH6100EG	5-39
403610	MXZ030	9-27	404479	CSBBRP0150EG	10-20	574360	EYEBH6150EG	5-39
403615	MXZ040	9-27	404480	CSBBRP0200EG	10-20	574410	LAM830	5-48
403620	MXZ047	9-27	404538	CSBRS2	10-22	574420	LAM1040	5-48
403625	MXZ054	9-27	404539	CSBRS3	10-22	574430	LAM1250	5-48
403630	MXZ062	9-27	570140	2200EG	5-6	574600	SSG022RO	9-21
403635	MXZ069	9-27	570160	2300EG	5-6	574610	SSG028RO	9-21
403645	MXZ078	9-27	570180	2400EG	5-6	574620	SSG035RO	9-21
403650	MXZ084	9-27	570240	2025EG	11-58	574630	SSG043RO	9-21
403655	MXZ091	9-27	570310	2002EG	11-56	574640	SSG049RO	9-21
403660	MXZ098	9-27	570350	2006EG	11-56	574650	SSG061RO	9-21
403665	MXZ107	9-27	570410	3300EG	5-6	574660	SSG077RO	9-21
403670	MXZ110	9-27	570420	3400EG	5-6	574670	SSG090RO	9-21
403675	MXZ116	9-27	570430	3500EG	5-6	574680	SSG115RO	9-21
403680	MXZ126	9-27	570440	3600EG	5-6	574685	SSG141RO	9-21
403690	MXZ141	9-27	570500	3025EG	11-58	574690	SSG170RO	9-21
403695	MXZ154	9-27	570560	3001EG	11-57	574700	SSG222RO	9-21
403705	MXZ168	9-27	570570	3002EG	11-57	574710	SSG276RO	9-21

E. Index – Article Number / Part Number

Article Number	Part Number	Page	Article Number	Part Number	Page	Article Number	Part Number	Page
574720	SSG327RO	9-21	577041	HDI065	9-17	578040	PXI118EG	9-18
574725	SSG0359RO	9-21	577043	HDI078	9-17	578080	PXI145EG	9-18
574730	SSG410RO	9-21	577045	HDI093	9-17	578120	PXI170EG	9-18
575001	HDN019HD	9-23	577048	HDI116	9-17	578180	PXI220EG	9-18
575002	HDN024HD	9-23	577050	HDI129	9-17	578250	PXI013S6	9-18
575003	HDN030HD	9-23	577051	HDI137	9-17	578260	PXI018S6	9-18
575004	HDN035HD	9-23	577052	HDI145	9-17	578270	PXI022S6	9-18
575006	HDN045HD	9-23	577053	HDI154	9-17	578280	PXI028S6	9-18
575007	HDN053HD	9-23	577054	HDI162	9-17	578290	PXI034S6	9-18
575008	HDN059HD	9-23	577055	HDI171	9-17	578310	PXI045S6	9-18
575009	HDN065HD	9-23	577058	HDI203	9-17	578320	PXI050S6	9-18
575011	HDN081HD	9-23	577059	HDI214	9-17	578340	PXI061S6	9-18
575013	HDN094HD	9-23	577060	PXN025EG	9-24	578370	PXI081S6	9-18
575016	HDN116HD	9-23	577061	HDI225	9-17	578390	PXI093S6	9-18
575018	HDN129HD	9-23	577064	HDI250	9-17	578400	PXI099S6	9-18
575020	HDN146HD	9-23	577066	HDI273	9-17	578410	PXI105S6	9-18
575022	HDN165HD	9-23	577067	HDI316	9-17	578420	PXI111S6	9-18
575023	HDN173HD	9-23	577068	HDN316	9-22	578430	PXI118S6	9-18
575028	HDN226HD	9-23	577070	PXN031EG	9-24	578440	PXI125S6	9-18
575032	HDN273HD	9-23	577080	PXN036EG	9-24	578470	PXI145S6	9-18
576940	4G16M16WH	2-6	577100	PXN046EG	9-24	578480	PXI151S6	9-18
576950	4G16HWH	2-6	577110	PXN052EG	9-24	578500	PXI164S6	9-18
577001	HDN019	9-22	577130	PXN063EG	9-24	578510	PXI170S6	9-18
577002	HDN024	9-22	577150	PXN073EG	9-24	578520	PXI180S6	9-18
577003	HDN030	9-22	577160	PXN079EG	9-24	578540	PXI194S6	9-18
577004	HDN035	9-22	577180	PXN092EG	9-24	578550	PXI201S6	9-18
577005	HDN041	9-22	577220	PXN117EG	9-24	578570	PXI220S6	9-18
577006	HDN045	9-22	577260	PXN143EG	9-24	578680	IHT20	9-58
577007	HDN053	9-22	577300	PXN169EG	9-24	578695	IHT30	9-58
577008	HDN059	9-22	577370	PXN219EG	9-24	578730	PTC050EG	5-33
577009	HDN065	9-22	577400	PXN252EG	9-24	578800	PTC050S6	5-33
577010	HDN072	9-22	577460	PXN025S6	9-24	580091	SCLI1310010	9-45
577011	HDN081	9-22	577470	PXN031S6	9-24	580092	SCLI1310012	9-45
577013	HDN094	9-22	577480	PXN036S6	9-24	580093	SCLI1310016	9-45
577014	HDN102	9-22	577500	PXN046S6	9-24	580100	SCLI1310017	9-45
577015	HDN108	9-22	577510	PXN052S6	9-24	580105	SCLI1310018	9-45
577016	HDN116	9-22	577530	PXN063S6	9-24	580110	SCLI1310021	9-45
577018	HDN129	9-22	577560	PXN079S6	9-24	580111	SCLI1310022	9-45
577019	HDN140	9-22	577570	PXN086S6	9-24	580112	SCLI1310025	9-45
577020	HDN146	9-22	577580	PXN092S6	9-24	580120	SCLI1310027	9-45
577021	HDN155	9-22	577600	PXN105S6	9-24	580121	SCLI1310028	9-45
577022	HDN165	9-22	577620	PXN117S6	9-24	580122	SCLI1310030	9-45
577023	HDN173	9-22	577640	PXN129S6	9-24	580130	SCLI1310034	9-45
577024	HDN182	9-22	577660	PXN143S6	9-24	580135	SCLI1310035	9-45
577025	HDN194	9-22	577690	PXN163S6	9-24	580140	SCLI1310042	9-45
577026	HDN205	9-22	577700	PXN169S6	9-24	580145	SCLI1310044	9-45
577027	HDN216	9-22	577710	PXN175S6	9-24	580150	SCLI1310049	9-45
577028	HDN226	9-22	577720	PXN182S6	9-24	580151	SCLI1310054	9-45
577029	HDN236	9-22	577750	PXN205S6	9-24	580152	SCLI1310057	9-45
577030	HDN250	9-22	577770	PXN219S6	9-24	580160	SCLI1310060	9-45
577031	HDN261	9-22	577800	PXN252S6	9-24	580170	SCLI1310064	9-45
577032	HDN273	9-22	577870	PXI018EG	9-18	580270	SCLI1910010	9-45
577033	HDI018	9-17	577880	PXI022EG	9-18	580280	SCLI1910012	9-45
577034	HDI023	9-17	577890	PXI028EG	9-18	580290	SCLI1910016	9-45
577035	HDI028	9-17	577900	PXI034EG	9-18	580300	SCLI1910017	9-45
577036	HDI033	9-17	577920	PXI045EG	9-18	580305	SCLI1910018	9-45
577037	HDI037	9-17	577930	PXI050EG	9-18	580310	SCLI1910021	9-45
577038	HDI045	9-17	577950	PXI061EG	9-18	580311	SCLI1910022	9-45
577039	HDI052	9-17	577980	PXI081EG	9-18	580312	SCLI1910025	9-45
577040	HDI058	9-17	578000	PXI093EG	9-18	580320	SCLI1910027	9-46

E. Index – Article Number / Part Number

Article Number	Part Number	Page	Article Number	Part Number	Page	Article Number	Part Number	Page
580321	SCLI19I0028	9-46	584410	MTSB4	5-53	586006	MFD044	9-10
580322	SCLI19I0030	9-46	584430	MTSH4	5-53	586007	MFD050	9-10
580330	SCLI19I0034	9-46	584455	MTVB8100	5-54	586008	MFD058	9-10
580335	SCLI19I0035	9-46	584456	MTVB8200	5-54	586009	MFD068	9-10
580340	SCLI19I0042	9-46	584465	MTVB10100	5-54	586010	MFD078	9-10
580345	SCLI19I0044	9-46	584466	MTVB10200	5-54	586011	MFD088	9-10
580350	SCLI19I0049	9-46	584510	CFIXM8	11-44	586012	MFD098	9-10
580351	SCLI19I0054	9-46	584520	CFIXM10	11-44	586013	MFD108	9-10
580352	SCLI19I0057	9-46	584530	CFIXM8030	11-45	586014	MFD118	9-10
580360	SCLI19I0060	9-46	584540	CFIXM8040	11-45	586015	MFD128	9-10
580365	SCLI19I0064	9-46	584550	CFIXM8060	11-45	586016	MFD138	9-10
580560	PESMO	9-42	584560	CFIXM10040	11-45	586017	MFD148	9-10
580561	PESMOS	9-42	584596	120828	5-39	586018	MFD160	9-10
580562	PESMT	9-43	584597	121028	5-39	586019	MFD170	9-10
580563	PESMTS	9-43	584600	120840	5-39	586020	MFD200	9-10
580564	PESHO	9-40	584610	121040	5-39	586021	MFD215	9-10
580565	PESHOS	9-40	584611	121340	5-39	586022	MFD225	9-10
580566	PESHT	9-41	584612	121740	5-39	586023	MFD250	9-10
580567	PESHTS	9-41	584660	EBS25A090	11-52	586024	MFD275	9-10
581600	SCLI13I0070	9-45	584666	EBL250A90	11-53	586025	MFD319	9-10
581610	SCLI13I0076	9-45	584668	EBL25A135	11-53	586101	MFN019EG	9-25
581620	SCLI13I0089	9-45	584670	SHSGE03	11-55	586102	MFN023EG	9-25
581630	SCLI13I0102	9-45	584671	SHSGE4	11-55	586103	MFN029EG	9-25
581640	SCLI13I0108	9-45	584672	SHLGE03	11-54	586104	MFN035EG	9-25
581650	SCLI13I0114	9-45	584673	SHLGE4	11-54	586105	MFN041EG	9-25
581660	SCLI19I0070	9-46	584710	APXE23EG	11-62	586106	MFN048EG	9-25
581670	SCLI19I0076	9-46	584715	APXE01EG	11-62	586107	MFN054EG	9-25
581680	SCLI19I0089	9-46	584725	APXE4STRUTEG	11-62	586108	MFN062EG	9-25
581690	SCLI19I0102	9-46	584740	APYE23EG	11-62	586109	MFN072EG	9-25
581700	SCLI19I0108	9-46	584751	APYE4STRUTEG	11-62	586110	MFN083EG	9-25
581710	SCLI19I0114	9-46	584758	APYE01EG	11-62	586111	MFN093EG	9-25
581715	SCLI19I0125	9-46	584820	APXSTRUTS6	11-62	586112	MFN103EG	9-25
581720	SCLI19I0133	9-46	584840	APYSTRUTS6	11-62	586113	MFN113EG	9-25
581725	SCLI19I0139	9-46	585010	KP3408060	11-46	586114	MFN123EG	9-25
581730	SCLI19I0160	9-46	585050	KP3408030	11-46	586115	MFN133EG	9-25
581735	SCLI19I0168	9-46	585060	KP3408050	11-46	586116	MFN143EG	9-25
583550	ETP050	5-32	585110	BCE4	11-54	586117	MFN153EG	9-25
583570	ETP100	5-32	585120	BCE03	11-54	586118	MFN165EG	9-25
583580	RTUM8	5-34	585200	120628	5-39	586119	MFN175EG	9-25
583590	RTUM10	5-34	585250	E23CNM6	11-47	586120	MFN205EG	9-25
583600	RTUM8L15	5-34	585260	E23CNM8	11-47	586121	MFN220EG	9-25
583610	RTUM10L18	5-34	585270	E23CNM10	11-47	586122	MFN230EG	9-25
583620	RTUM12L20	5-34	585380	ADKE1	11-44	586123	MFN255EG	9-25
583630	RTUM10L30	5-34	585400	ADKE3	11-44	586124	MFN280EG	9-25
583710	RMFM6M8	5-34	585430	ECNUNI06	11-46	586125	MFN324EG	9-25
583720	RMFM8M6	5-34	585440	ECNUNI08	11-46	586201	MFE015	9-9
583730	RMFM8M10	5-34	585450	ECNUNI10	11-46	586202	MFE019	9-9
583740	RMFM8M12	5-34	585480	E2L15H2000PG	11-42	586203	MFE025	9-9
583750	RMFM10M8	5-34	585500	E120H2000PG	11-41	586204	MFE031	9-9
583760	RMFM10M12	5-34	585550	E320H3000PG	11-42	586205	MFE037	9-9
583770	RMFM12M8	5-34	585560	E320H2000PG	11-42	586206	MFE044	9-9
583780	RMFM12M10	5-34	585780	RACE3	11-55	586207	MFE050	9-9
583850	VDFCM8040	5-35	585860	CE320H0250EG	11-50	586208	MFE058	9-9
583870	RFFM8M10	5-33	585870	CE320H0500EG	11-50	586209	MFE068	9-9
583880	RFFM8M12	5-33	585880	CE320H0750EG	11-50	586301	MFD015S6	9-11
583890	RFFM10M12	5-33	586001	MFD015	9-10	586302	MFD019S6	9-11
583920	ABP12PG	9-49	586002	MFD019	9-10	586303	MFD025S6	9-11
583930	ABP17PG	9-49	586003	MFD025	9-10	586304	MFD031S6	9-11
583940	ABP26PG	9-49	586004	MFD031	9-10	586305	MFD037S6	9-11
584020	ABP12S4	9-49	586005	MFD037	9-10	586306	MFD044S6	9-11

E. Index – Article Number / Part Number

Article Number	Part Number	Page	Article Number	Part Number	Page	Article Number	Part Number	Page
586307	MFD050S6	9-11	586523	MFVN0710EG	9-48	588670	ITP075	5-32
586308	MFD058S6	9-11	586524	MFVN0800EG	9-48	589295	325M10HD	5-18
586309	MFD068S6	9-11	586525	MFVN0900EG	9-48	589296	325M12HD	5-18
586310	MFD078S6	9-11	586526	MFVN1000EG	9-48	589300	ABCM8M10	5-24
586311	MFD088S6	9-11	586527	MFVN1120EG	9-48	589310	SXE058	9-15
586312	MFD098S6	9-11	586528	MFVN1250EG	9-48	589320	SXE061	9-15
586313	MFD108S6	9-11	586601	MFVI0080EG	9-47	589350	SXD058	9-16
586314	MFD118S6	9-11	586602	MFVI0090EG	9-47	589890	LAM625	5-48
586315	MFD128S6	9-11	586603	MFVI0100EG	9-47	589921	PLN13S6	11-17
586316	MFD138S6	9-11	586604	MFVI0112EG	9-47	589925	PLN8	11-17
586317	MFD148S6	9-11	586605	MFVI0125EG	9-47	589927	PLN10S6	11-17
586318	MFD160S6	9-11	586606	MFVI0140EG	9-47	589928	PLN11S6	11-17
586319	MFD170S6	9-11	586607	MFVI0150EG	9-47	589930	PLN10	11-17
586320	MFD200S6	9-11	586608	MFVI0160EG	9-47	589940	PLN13	11-17
586321	MFD215S6	9-11	586609	MFVI0180EG	9-47	589949	PLN13HD	11-17
586322	MFD225S6	9-11	586610	MFVI0200EG	9-47	589990	KIT600ISO	11-60
586401	MFN019S6	9-26	586611	MFVI0224EG	9-47	590010	KIT600	11-60
586402	MFN023S6	9-26	586612	MFVI0250EG	9-47	590074	KP2708020	11-45
586403	MFN029S6	9-26	586613	MFVI0280EG	9-47	590076	KP2708030	11-45
586404	MFN035S6	9-26	586614	MFVI0300EG	9-47	590077	KP2708040	11-45
586405	MFN041S6	9-26	586615	MFVI0315EG	9-47	590080	TMN08040EG	11-12
586406	MFN048S6	9-26	586616	MFVI0355EG	9-47	590082	KP2708080	11-45
586407	MFN054S6	9-26	586617	MFVI0400EG	9-47	590087	KP2710030	11-45
586408	MFN062S6	9-26	586618	MFVI0450EG	9-47	590090	TMN10040EG	11-12
586409	MFN072S6	9-26	586619	MFVI0500EG	9-47	590093	TMN08040S4	11-12
586410	MFN083S6	9-26	586620	MFVI0560EG	9-47	590094	TMN10040S4	11-12
586411	MFN093S6	9-26	586621	MFVI0600EG	9-47	590095	TMN12040S4	11-12
586412	MFN103S6	9-26	586622	MFVI0630EG	9-47	590100	TMN12040EG	11-12
586413	MFN113S6	9-26	586623	MFVI0710EG	9-47	590201	KP3808025	11-46
586414	MFN123S6	9-26	586624	MFVI0800EG	9-47	590207	KP3810035	11-46
586415	MFN133S6	9-26	586625	MFVI0900EG	9-47	590210	KP3808040	11-46
586416	MFN143S6	9-26	586626	MFVI1000EG	9-47	590218	TMN10030EG	11-12
586417	MFN153S6	9-26	586627	MFVI1120EG	9-47	590220	TMN08030EG	11-12
586418	MFN165S6	9-26	586628	MFVI1250EG	9-47	590221	TMN08050EG	11-12
586419	MFN175S6	9-26	587120	PBT050L120	5-25	590222	TMN08060EG	11-12
586420	MFN205S6	9-26	587125	PBT050L80	5-25	590223	TMN08100EG	11-12
586421	MFN220S6	9-26	587135	PBRM10L80	5-25	590224	TMN10050EG	11-12
586422	MFN230S6	9-26	587140	PBRM8M10L120	5-25	590225	TMN10060EG	11-12
586501	MFVN0080EG	9-48	587145	PBRM8M10L80	5-25	590227	TMN10080EG	11-12
586502	MFVN0090EG	9-48	587160	PBRM10L120	5-25	590240	035RS300	5-4
586503	MFVN0100EG	9-48	587165	PBRM12L120	5-25	590330	KP3810050	11-46
586504	MFVN0112EG	9-48	587175	PBRM8M10L70S6	5-25	591070	FXBC10S2	9-54
586505	MFVN0125EG	9-48	587510	EBL35A090	11-53	591080	FXBC20S2	9-54
586506	MFVN0140EG	9-48	587520	EBL35A135	11-53	591200	FXBF10X50MS2	9-55
586507	MFVN0150EG	9-48	587530	EBS35A090	11-52	591210	FXBF12X50MS2	9-55
586508	MFVN0160EG	9-48	588170	PCG	9-44	591220	FXBF16X50MS2	9-55
586509	MFVN0180EG	9-48	588240	PLNE008	11-52	591230	FXBF20X50MS2	9-55
586510	MFVN0200EG	9-48	588250	PLNE010	11-52	591250	FXBB10S2	9-54
586511	MFVN0224EG	9-48	588260	PLNE1208	11-52	591260	FXBB12S2	9-54
586512	MFVN0250EG	9-48	588280	PLNE3408	11-52	591270	FXBB16S2	9-54
586513	MFVN0280EG	9-48	588285	PLNE3410	11-52	591280	FXBB20S2	9-54
586514	MFVN0300EG	9-48	588290	PLUN10	11-52	591290	FXBTOOL	9-55
586515	MFVN0315EG	9-48	588440	ISOF08F08EG	9-56	591350	BP17PG	9-50
586516	MFVN0355EG	9-48	588500	ISOHD16EG	9-58	591360	BP25PG	9-50
586517	MFVN0400EG	9-48	588560	ISOF08M08EG	9-57	591410	CHN13KSP	2-3
586518	MFVN0450EG	9-48	588580	ISOF10M10EG	9-57	591500	CHN15KS4	2-3
586519	MFVN0500EG	9-48	588610	SBMKM8	9-57	591510	CHN17KS4	2-3
586520	MFVN0560EG	9-48	588620	SBFKM8	9-57	591570	S30EG	2-4
586521	MFVN0600EG	9-48	588630	SBMKM10	9-57	591580	S40EG	2-4
586522	MFVN0630EG	9-48	588660	ITP050	5-32	591590	S50EG	2-4

E. Index – Article Number / Part Number

Article Number	Part Number	Page	Article Number	Part Number	Page	Article Number	Part Number	Page
591650	S40S4	2-4	593150	TCAM6030	5-48	596010	MDC023	9-19
591660	S50S4	2-4	593160	TCAM8030	5-48	596020	MDC028	9-19
592040	010M6	5-37	593165	TCAM8040	5-48	596030	MDC035	9-19
592050	010M8	5-37	593170	TCAM10040	5-48	596040	DUPLON15EG	9-28
592060	010M10	5-37	593180	CAM6030	5-47	596041	DUPLON22EG	9-28
592065	010M10HD	5-37	593190	CAM8030	5-47	596042	DUPLON28EG	9-28
592070	010M12	5-37	593195	CAM8040	5-47	597500	CE224H0200EG	11-50
592075	010M12HD	5-37	593200	CAM10040	5-47	597510	CE224H0300EG	11-50
592140	010M8S4	5-37	593210	CFH838	5-49	597575	TBHS	9-52
592150	010M10S4	5-37	593220	CFH1060	5-49	597581	TBHK	5-21
592160	010M12S4	5-37	593270	VDFM8050	5-36	597582	TBHKM8	5-21
592305	025M6EG	5-32	593280	VDFM8060	5-36	597583	TBHKM10	5-21
592335	025M12EG	5-32	593290	VDFM8070	5-36	597615	UB4N027M8S6	9-39
592336	025M16EG	5-32	593300	VDFM8080	5-36	597625	UB4N034M8S6	9-39
592340	025M8EG	5-32	593310	VDFM8100	5-36	597635	UB4N042M8S6	9-39
592350	025M10EG	5-32	593330	VDFM10060	5-36	597645	UB4N049M8S6	9-39
592390	01106EG	5-38	593340	VDFM10080	5-36	597655	UB4N060M8S6	9-39
592400	01108EG	5-38	593350	VDFM10100	5-36	597665	UB4N076M8S6	9-39
592410	01110EG	5-38	593370	VDFM10120	5-36	597770	EQVS	9-52
592415	01110HD	5-38	593400	VDFM8120	5-36	597780	EQLS85	9-51
592420	01112EG	5-38	593410	VDFM8150	5-36	597790	EQZS	9-51
592425	01112HD	5-38	593420	VDFM8200	5-36	597791	EQLS50	9-51
592480	01106S4	5-38	593440	051SM8030	5-31	597792	EQLS130	9-51
592490	01108S4	5-38	593450	051SM8050	5-31	597805	SOSR075	9-38
592500	01110S4	5-38	593465	051M8070	5-30	597806	SOSR100	9-38
592510	01112S4	5-38	593476	051M8120	5-30	597807	SOSR125	9-38
592570	050M61000	5-31	593477	051M8150	5-30	597808	SOSR150	9-38
592580	050M62000	5-31	593490	051SM10050	5-31	597809	SOSR200	9-38
592590	050M81000	5-31	593505	051M10090	5-30	597816	1070075EG	9-37
592600	050M82000	5-31	593516	051M10150	5-30	597817	1070100EG	9-37
592610	050M101000	5-31	593560	VDFM10050	5-36	597818	1070125EG	9-37
592615	050M101000HD	5-31	593570	VDFM10150	5-36	597819	1070150EG	9-37
592620	050M102000	5-31	593580	VDFM10200	5-36	597821	1070200EG	9-37
592630	050M121000	5-31	593680	HSCRM825EG	5-36	597822	1080075EG	9-37
592635	050M121000HD	5-31	593745	HSCRM1025HD	5-36	597823	1080100EG	9-37
592640	050M122000	5-31	593755	HSCRM1030HD	5-36	597824	1080125EG	9-37
592650	050M63000	5-31	593765	HSCRM1230HD	5-36	597825	1080150EG	9-37
592660	050M83000	5-31	595035	MPL016	9-14	597826	1080200EG	9-37
592670	050M103000	5-31	595036	MPL020	9-14	597827	1090075EG	9-38
592680	050M123000	5-31	595037	MPL025	9-14	597828	1090100EG	9-38
592700	050M61000S4	5-31	595038	MPL032	9-14	597829	1090125EG	9-38
592710	050M62000S4	5-31	595039	MPL040	9-14	597831	1090150EG	9-38
592720	050M81000S4	5-31	595040	MPL050	9-14	597832	1090200EG	9-38
592730	050M82000S4	5-31	595042	MPL063	9-14	597860	115M0050EG	9-4
592740	050M101000S4	5-31	595043	MPL075	9-14	597865	SR6	9-8
592750	050M102000S4	5-31	595044	MPL090	9-14	597866	SR0100EG	9-8
592760	050M121000S4	5-31	595045	MPL110	9-14	597867	SR0125EG	9-8
592850	THMFM816	5-37	595046	MPL125	9-14	597868	SR0150EG	9-8
592900	QSNM6EG	11-8	595047	MPL140	9-14	597869	SR0200EG	9-8
592910	QSNM8EG	11-8	595048	MPL160	9-14	597870	115M0075EG	9-4
592912	QSNM8040EG	11-8	595052	MPZ020	9-28	597880	115M0100EG	9-4
592914	QSNM8060EG	11-8	595053	MPZ025	9-28	597890	115M0125EG	9-4
592920	QSNM10EG	11-8	595054	MPZ032	9-28	597900	115M0150EG	9-4
592922	QSNM10040EG	11-8	595056	MPZ040	9-28	597910	115M0200EG	9-4
592924	QSNM10060EG	11-8	595057	MPZ050	9-28	597920	115M0250EG	9-4
592930	QSNM12EG	11-8	595059	MPZ063	9-28	597930	115M0300EG	9-4
593090	CLM6030	5-49	595061	MPZ075	9-28	597940	115M0400EG	9-4
593100	CLM8040	5-49	595062	MPZ090	9-28	597950	115M0500EG	9-4
593110	CLM10040	5-49	595063	MPZ110	9-28	597960	115M0600EG	9-4
593145	TCAM6025	5-48	596000	MDC019	9-19	597962	FCS0075M8	9-6

E. Index – Article Number / Part Number

Article Number	Part Number	Page	Article Number	Part Number	Page	Article Number	Part Number	Page
597963	FCS0100M8	9-6	599343	UB4N323M10	9-39	712280	USC159EG	9-32
597964	FCS0125M8	9-6	599345	UB4N017M8S6	9-39	712290	USC168EG	9-32
597965	FCS0150M8	9-6	599346	UB4N021M8S6	9-39	712300	USC178EG	9-32
597966	FCS0200M8	9-6	599348	UB4N114M8S6	9-39	712340	USC218EG	9-32
597968	FCS0075M10	9-6	599350	UB4N140M8S6	9-39	712405	USC021HD	9-33
597969	FCS0100M10	9-6	599351	UB4N160M8S6	9-39	712410	USC022HD	9-33
597970	115M0800EG	9-4	599352	UB4N168M8S6	9-39	712422	USC026HD	9-33
597971	FCS0125M10	9-6	599354	UB4N219M10S6	9-39	712428	USC033HD	9-33
597972	FCS0150M10	9-6	599355	UB4N273M10S6	9-39	712430	USC036HD	9-33
597973	FCS0200M10	9-6	599356	UB4N323M10S6	9-39	712445	USC042HD	9-33
597974	FCS0250M10	9-6	599357	UB4N090M8S6	9-39	712452	USC048HD	9-33
597975	FCS0300M10	9-6	599500	ESSUHS	9-55	712460	USC058HD	9-33
597976	FCS0400M10	9-6	599501	ESSUH	9-56	712465	USC060HD	9-33
597977	FCS0500M12	9-6	599504	ESSST	9-56	712475	USC076HD	9-33
597978	FCS0600M12	9-6	599879	CE0L13H0180EG	11-49	712480	USC086HD	9-33
597979	FCS0800M16	9-6	599880	CE0L13H0300EG	11-49	712490	USC113HD	9-33
597981	FCS1000M20	9-6	599885	CE015H0180EG	11-49	712520	USC218HD	9-33
597982	NUTFLM8	9-7	599890	CE015H0240EG	11-49	712530	USC277HD	9-33
597983	NUTFLM10	9-7	599900	CE015H0300EG	11-49	800070	SCMDSN	5-51
598151	FCSNUT8	9-7	599905	CE015H0360EG	11-49	800071	SCMND	5-50
598152	FCSNUT10S	9-7	599910	CE015H0420EG	11-49	-	CSBBS121836	10-19
598153	FCSNUT10L	9-7	599920	CE015H0540EG	11-49	-	CRLAKITA	6-6
598154	FCSNUT12	9-7	599925	CE015H0660EG	11-49			
598155	FCSNUT16	9-7	599930	CE015H0780EG	11-49			
598156	FCSNUT20	9-7	599935	CE420H0200EG	11-51			
598290	038M0010EG	5-19	599950	CE420H0300EG	11-51			
598883	CCC0037	9-31	599960	CE420H0350EG	11-51			
598884	CCC0050	9-31	599970	CE420H0450EG	11-51			
598886	CCC0062	9-31	599980	CE420H0550EG	11-51			
598888	CCC0075	9-31	599990	CE420H0650EG	11-51			
598891	CCC0087	9-31	599995	CE420H0800EG	11-51			
598892	CCC0100	9-31	599996	E0L13H2000PG	11-41			
598894	CCC0112	9-31	599997	E015H2000PG	11-41			
598895	CCC0125	9-31	599998	E420H2000PG	11-43			
598899	CCC0162	9-31	599999	E420H6000PG	11-43			
598903	CCC0187	9-31	600000	E420H3000PG	11-43			
598906	CCC0212	9-31	702065	7000250S4	9-30			
598908	CCC0237	9-31	712030	USC016EG	9-32			
598957	CCC0450	9-31	712035	USC060EG	9-32			
598984	DHM0100EG	9-5	712040	USC020EG	9-32			
598985	DHM0125EG	9-5	712045	USC021EG	9-32			
598994	DHM0150EG	9-5	712050	USC022EG	9-32			
598995	DHM0200EG	9-5	712060	USC025EG	9-32			
599110	UB4N017M6	9-39	712065	USC026EG	9-32			
599120	UB4N021M6	9-39	712070	USC028EG	9-32			
599130	UB4N027M8	9-39	712080	USC031EG	9-32			
599140	UB4N034M8	9-39	712085	USC033EG	9-32			
599150	UB4N042M8	9-39	712090	USC036EG	9-32			
599160	UB4N049M8	9-39	712100	USC040EG	9-32			
599170	UB4N060M8	9-39	712105	USC042EG	9-32			
599180	UB4N076M8	9-39	712110	USC046EG	9-32			
599190	UB4N090M10	9-39	712115	USC048EG	9-32			
599200	UB4N114M10	9-39	712120	USC053EG	9-32			
599240	UB4N168M14	9-39	712140	USC063EG	9-32			
599250	UB4N219M16	9-39	712160	USC073EG	9-32			
599260	UB4N273M16	9-39	712165	USC076EG	9-32			
599334	UB4N090M8	9-39	712180	USC086EG	9-32			
599337	UB4N140M8	9-39	712200	USC101EG	9-32			
599338	UB4N160M8	9-39	712220	USC113EG	9-32			
599341	UB4N219M10	9-39	712260	USC143EG	9-32			

F. Index – Part Number / Article Number

Part Number	Article Number	Page	Part Number	Article Number	Page	Part Number	Article Number	Page
008017EG	400678	9-35	051M10025	400345	5-30	4H24CTR5	191021	1-13
008021EG	400679	9-35	051M10040	400346	5-30	4H24CTS1	160500	1-13
008027EG	400680	9-35	051M10060	400347	5-30	4H24I	170150	5-14
008034EG	400681	9-35	051M10080	400349	5-30	4H24IM11	170140	5-14
008042EG	400682	9-35	051M10090	593505	5-30	4H24R5	191018	5-13
008048EG	400683	9-35	051M10100	400351	5-30	4H24S1	179610	5-13
008060EG	400684	9-35	051M10150	593516	5-30	4H24SP25	172320	5-13
010M10	592060	5-37	051M12040	400355	5-30	4H24ST3	171500	1-15
010M10HD	592065	5-37	051M8025	400336	5-30	4H24ST3SP25	172340	1-15
010M10S4	592150	5-37	051M8040	400337	5-30	4H58	170030	5-13
010M12	592070	5-37	051M8060	400338	5-30	4H58CT	178530	1-13
010M12HD	592075	5-37	051M8070	593465	5-30	4H58CTBB	170240	1-12
010M12S4	592160	5-37	051M8080	400340	5-30	4H58CTBRS1	170300	1-12
010M16	400444	5-37	051M8100	400342	5-30	4H58CTBW	170190	1-12
010M6	592040	5-37	051M8120	593476	5-30	4H58CTIN	160480	1-14
010M8	592050	5-37	051M8150	593477	5-30	4H58CTR5	191022	1-13
010M8S4	592140	5-37	051SM10050	593490	5-31	4H58CTS1	170430	1-13
01106EG	592390	5-38	051SM8030	593440	5-31	4H58CTSP25	172360	1-13
01106S4	592480	5-38	051SM8050	593450	5-31	4H58I	170250	5-14
01108EG	592400	5-38	2H4	170010	5-13	4H58IM11	170160	5-14
01108S4	592490	5-38	2H41214A	170470	1-14	4H58R5	191019	5-13
01110EG	592410	5-38	2H41214B	170840	1-15	4H58S1	179620	5-13
01110HD	592415	5-38	2H4CT	178510	1-13	4H58SP25	172350	5-13
01110S4	592500	5-38	2H4CTBB	170210	1-12	4H58ST3	171530	1-15
01112EG	592420	5-38	2H4CTBW	170170	1-12	4H58ST3SP25	172370	1-15
01112HD	592425	5-38	2H4ST3	173420	1-15	4H912	170040	5-13
01112S4	592510	5-38	4G16H	170230	2-6	4H912CT	178540	1-13
01116EG	400448	5-38	4G16HWH	576950	2-6	4H912CTBB	170260	1-12
025DM10S4	401146	5-33	4G16LS	171670	2-5	4H912CTBRS1	170310	1-12
025DM8S4	401145	5-33	4G16M11	178600	2-6	4H912CTBW	170200	1-12
025M10EG	592350	5-32	4G16M11WH	178620	2-6	4H912CTIN	160490	1-14
025M12EG	592335	5-32	4G16M16	171900	2-6	4H912CTR5	191023	1-13
025M16EG	592336	5-32	4G16M16WH	576940	2-6	4H912CTS1	170700	1-13
025M6EG	592305	5-32	4G16M25	176880	2-6	4H912CTSP25	172390	1-13
025M8EG	592340	5-32	4G16M7	178590	2-6	4H912R5	191045	5-13
035RS300	590240	5-4	4G16WN	176710	2-6	4H912S1	179630	5-13
038M0010EG	598290	5-19	4G24H	170490	2-8	4H912SP25	172380	5-13
042H8065	400405	5-35	4G24HWH	170500	2-8	4H912ST3	171640	1-15
050M101000	592610	5-31	4G24HWHSP25	172280	2-8	4H912ST3S1	171550	1-15
050M101000HD	592615	5-31	4G24M11	171680	2-7	4H912ST3SP25	172400	1-15
050M101000S4	592740	5-31	4G24M11WH	171840	2-7	4J15M	178860	2-8
050M102000	592620	5-31	4G24M16	171710	2-7	4QTI	174801	5-26
050M102000S4	592750	5-31	4G24M16WH	171860	2-7	4QTI24	174841	5-16
050M103000	592670	5-31	4G24M16WHSP25	172290	2-7	4QTI4	174842	5-16
050M121000	592630	5-31	4G24M25	171730	2-7	4QTI58	174843	5-16
050M121000HD	592635	5-31	4G24M25WHSP25	172300	2-7	4QTI912	174844	5-16
050M121000S4	592760	5-31	4G24WN	160290	2-7	4QTIBC	170381	5-15
050M122000	592640	5-31	4H1318	170045	5-13	4QTIGBSF	170896	5-27
050M123000	592680	5-31	4H1318CT	178545	1-13	4Z34	170650	5-30
050M161000	400332	5-31	4H1318ST3	171775	1-15	4Z34812M	171060	1-18
050M61000	592570	5-31	4H24	170020	5-13	4Z34CTS	172950	1-28
050M61000S4	592700	5-31	4H241012A	170480	1-14	6EM24	173550	1-4
050M62000	592580	5-31	4H241012B	170850	1-15	6EM58	171750	1-4
050M62000S4	592710	5-31	4H241214A	170630	1-14	6M	170790	1-19
050M63000	592650	5-31	4H241214B	170640	1-15	6M24SM	173640	1-5
050M81000	592590	5-31	4H24CT	178520	1-13	6M58SM	171980	1-5
050M81000S4	592720	5-31	4H24CTBB	170220	1-12	6M912SM	173650	1-5
050M82000	592600	5-31	4H24CTBRS1	170280	1-12	6WN	171560	2-8
050M82000S4	592730	5-31	4H24CTBW	170180	1-12	6Z34	170720	5-30
050M83000	592660	5-31	4H24CTIN	160470	1-14	6Z34812M	171090	1-18

F. Index – Part Number / Article Number

Part Number	Article Number	Page	Part Number	Article Number	Page	Part Number	Article Number	Page
6Z34CTS	172960	1-28	2300EG	570160	5-6	325M12HD	589296	5-18
8EM24S1	179780	1-4	2400EG	570180	5-6	812EM1318	160075	1-4
8EM58S1	179790	1-4	24EM24	171960	1-4	812EM24	160120	1-4
8EM912S1	179800	1-4	24EM58	171970	1-4	812EM58	160130	1-4
8M24SMS1	179650	1-5	24EM912	173590	1-4	812EM912	160140	1-4
8M58SMS1	179660	1-5	24M	170120	1-19	812M	177130	1-19
8M912SMS1	179670	1-5	24M24SM	176690	1-5	812M1318SM	160145	1-5
8MS1	179900	1-19	24M4SM	173790	1-5	812M24SM	160050	1-5
8P	171130	1-19	24M58SM	173800	1-5	812M58SM	160060	1-5
8P12P	171230	1-20	24M912SM	173810	1-5	812M912SM	160070	1-5
8P24	172150	1-2	24SC1011	187550	1-10	812MATA	177190	2-2
8P24IN	175300	1-3	24SC1214	187570	1-10	812MATS	177200	2-3
8P24SM	175180	1-3	24SC1518	187590	1-10	812SC1011	187660	1-10
8P4SM	175170	1-3	24SC1518R25	191003	1-10	812SC1214	187670	1-10
8P58	172160	1-2	24SC1924	187610	1-10	812SC1518	187680	1-10
8P58IN	175310	1-3	24SC1924R25	191004	1-10	812SC1518R25	191015	1-10
8P58SM	175190	1-3	24SC2530	187630	1-10	812SC1924	187690	1-10
8P912	175100	1-2	24SC2530R25	191005	1-10	812SC1924R25	191016	1-10
8P912SM	175200	1-3	24SC67	187510	1-10	812SC2530	187700	1-10
12EM58S1	179820	1-4	24SC78	187710	1-10	812SC2530R25	191017	1-10
12EM912S1	179830	1-4	24SC89	187530	1-10	812SC67	187640	1-10
12M24SMS1	179690	1-5	24SC910	187750	1-10	812SC78	187730	1-10
12M58SMS1	179700	1-5	32EM24	173600	1-4	812SC89	187650	1-10
12MS1	179910	1-19	32EM58	173610	1-4	812SC910	187770	1-10
12P	171150	1-19	32EM912	173620	1-4	2002EG	570310	11-56
12P12P	171250	1-20	32M	170130	1-19	2006EG	570350	11-56
12P16P	171260	1-20	32M24SM	173830	1-5	2025EG	570240	11-58
12P24	175110	1-2	32M58SM	173840	1-5	3001EG	570560	11-57
12P24SM	175220	1-3	47SC1011	187540	1-10	3002EG	570570	11-57
12P4IN	175320	1-3	47SC1214	187560	1-10	3003EG	570580	11-57
12P4SM	175210	1-3	47SC1518	187580	1-10	3004EG	570590	11-57
12P58	175120	1-2	47SC1518R25	191009	1-10	300M10	386820	5-2
12P58SM	175230	1-3	47SC1924	187600	1-10	300M12	386830	5-2
12P912	175130	1-2	47SC1924R25	191010	1-10	300M6	386805	5-2
12P912SM	175240	1-3	47SC2530	187620	1-10	300M8	386810	5-2
16EM1318	173745	1-4	47SC2530R25	191011	1-10	3025EG	570500	11-58
16EM24	171740	1-4	47SC67	187500	1-10	3300EG	570410	5-6
16EM58	171490	1-4	47SC78	187720	1-10	3400EG	570420	5-6
16EM912	173570	1-4	47SC89	187520	1-10	3500EG	570430	5-6
16M	170100	1-19	47SC910	187760	1-10	3600EG	570440	5-6
16M24SM	173720	1-5	115M0050EG	597860	9-4	5120HD	335100	11-54
16M58SM	173730	1-5	115M0075EG	597870	9-4	5190HD	335150	11-48
16M912SM	173740	1-5	115M0100EG	597880	9-4	5190S6	335160	11-48
16P	171170	1-19	115M0125EG	597890	9-4	5300HD	335000	5-7
16P16P	171270	1-20	115M0150EG	597900	9-4	5400HD	335010	5-7
16P24	175140	1-2	115M0200EG	597910	9-4	5400S4	335060	5-7
16P24SM	175260	1-3	115M0250EG	597920	9-4	5500HD	335020	5-7
16P4SM	175250	1-3	115M0300EG	597930	9-4	5600HD	335030	5-7
16P58	175150	1-2	115M0400EG	597940	9-4	5600S4	335080	5-7
16P58SM	175270	1-3	115M0500EG	597950	9-4	6000HBEG	388350	11-37
16P912	175160	1-2	115M0600EG	597960	9-4	6120HD	330600	11-31
16P912SM	175280	1-3	115M0800EG	597970	9-4	6120S4	330610	11-31
20EM24	171800	1-4	122	171690	5-9	6300AAHD	330100	5-7
20EM58	171950	1-4	122M10TI	175070	5-16	6300CCHD	330000	5-7
20EM912	173580	1-4	122M6TI	174890	5-16	6300SWHDEG	336000	5-8
20M	170110	1-19	122M8TI	174980	5-16	6400AAHD	330110	5-7
20M24SM	171720	1-5	123	171700	5-9	6400CCHD	330010	5-7
20M58SM	173770	1-5	310M10	389890	5-2	6500AAHD	330120	5-7
20M912SM	173780	1-5	310M12	388890	5-2	6500CCHD	330020	5-7
2200EG	570140	5-6	325M10HD	589295	5-18	6500SWHDEG	336020	5-8

F. Index – Part Number / Article Number

Part Number	Article Number	Page	Part Number	Article Number	Page	Part Number	Article Number	Page
6600AAHD	330130	5-7	4010600EG	179428	9-2	APXE01EG	584715	11-62
6600CCHD	330030	5-7	4010800EG	179429	9-2	APXE23EG	584710	11-62
6800AAHD	330140	5-7	4011000EG	179430	9-2	APXE4STRUTEG	584725	11-62
30009MM	389500	5-2	4011200EG	179431	9-2	APXSTRUTS6	584820	11-62
30011MM	389510	5-2	4100100EG	179400	9-3	APYE01EG	584758	11-62
30013MM	389520	5-2	4100125EG	179401	9-3	APYE23EG	584740	11-62
30017MM	389505	5-2	4100150EG	179402	9-3	APYE4STRUTEG	584751	11-62
120628	585200	5-39	4100200EG	179403	9-3	APYSTRUTS6	584840	11-62
120828	584596	5-39	4100250EG	179404	9-3	ATA4I	170400	2-2
120840	584600	5-39	4100300EG	179405	9-3	ATS4I	170420	2-2
121028	584597	5-39	4100400EG	179406	9-3	BARRNOG	187189	3-4
121040	584610	5-39	4100500EG	179407	9-3	BC200CD1B	182220	1-2
121340	584611	5-39	4100600EG	179408	9-3	BC200CD2B	182230	1-2
121740	584612	5-39	4100800EG	179409	9-3	BC200M6	181180	5-3
160000	160000	5-15	7000250S4	702065	9-30	BCE03	585120	11-54
160010	160010	5-15	A15L2000PG	317096	11-2	BCE4	585110	11-54
160030	160030	5-15	A15L3000HD	317241	11-2	BP17PG	591350	9-50
196855	196855	7-8	A15L3000PG	317099	11-2	BP25PG	591360	9-50
350000	350000	5-13	A15L6000HD	317251	11-2	BSZM6X35EG	402690	5-45
389001	389001	9-33	A15L6000PG	317111	11-2	BSZSU06040ZL	402605	5-44
389002	389002	9-33	A20L2000PG	310293	11-2	BSZSU06050ZL	402606	5-44
389003	389003	9-33	A20L3000PG	310303	11-2	BSZSU08070ZL	402610	5-44
389004	389004	9-33	A20L6000PG	310313	11-2	BSZSU10100ZL	402615	5-44
389005	389005	9-33	A25H2000PG	385505	11-2	BSZSU10120ZL	402620	5-44
389006	389006	9-33	A25H2000S6	310322	11-2	BSZSU12110ZL	402625	5-44
389007	389007	9-33	A25H3000HD	310339	11-2	BTF24	160820	1-28
389008	389008	9-33	A25H3000PG	310299	11-2	BTF58	160830	1-28
389009	389009	9-33	A25H4000PG	310333	11-2	BTF912	160840	1-28
389011	389011	9-33	A25H6000HD	310358	11-2	C100EC	337790	1-21
389013	389013	9-33	A25H6000PG	310311	11-2	C12EC	337600	1-21
389017	389017	9-33	A25H6000S6	310326	11-2	C12ES	337000	1-23
389018	389018	9-33	A25S3000HD	310400	11-3	C12EU	337300	1-22
389051	389051	9-34	A25S3000PG	310360	11-3	C12GW	337800	1-24
389052	389052	9-34	A25S6000HD	310410	11-3	C12LW	339500	1-24
1070075EG	597816	9-37	A25S6000PG	310370	11-3	C15L2000PG	317116	11-4
1070100EG	597817	9-37	AA25H0400HD	330390	11-3	C15L3000PG	317119	11-4
1070125EG	597818	9-37	AA25H0600HD	330410	11-3	C15L6000PG	317131	11-4
1070150EG	597819	9-37	AA25H0800HD	330420	11-3	C16EC	337610	1-21
1070200EG	597821	9-37	AA25H1000HD	330430	11-3	C16ES	337010	1-23
1080075EG	597822	9-37	AA25H2000HD	330440	11-3	C16EU	337310	1-22
1080100EG	597823	9-37	AA25H3000HD	310221	11-3	C16GW	337810	1-24
1080125EG	597824	9-37	AA25H3000PG	310181	11-3	C16LW	339510	1-24
1080150EG	597825	9-37	AA25H6000HD	310231	11-3	C20EC	337620	1-21
1080200EG	597826	9-37	AA25H6000PG	310191	11-3	C20ES	337020	1-23
1090075EG	597827	9-38	AB	171120	5-29	C20EU	337320	1-22
1090100EG	597828	9-38	AB11MM35X35	387976	5-28	C20GW	337820	1-24
1090125EG	597829	9-38	ABCM8M10	589300	5-24	C20HD	336100	1-26
1090150EG	597831	9-38	ABGBSF	173446	5-29	C20L2000PG	310256	11-4
1090200EG	597832	9-38	ABP12PG	583920	9-49	C20L3000PG	310257	11-4
4010050EG	179398	9-2	ABP12S4	584020	9-49	C20S4	336130	1-26
4010075EG	179399	9-2	ABP17PG	583930	9-49	C24EC	337630	1-21
4010100EG	179420	9-2	ABP26PG	583940	9-49	C24ES	337030	1-23
4010125EG	179421	9-2	ADK421	313305	11-7	C24EU	337330	1-22
4010150EG	179422	9-2	ADKE0	313302	11-44	C24GW	337830	1-24
4010200EG	179423	9-2	ADKE0L	313301	11-44	C25H2000PG	387365	11-4
4010250EG	179424	9-2	ADKE1	585380	11-44	C25H2000S6	317118	11-4
4010300EG	179425	9-2	ADKE2	313304	11-44	C25H3000HD	310281	11-4
4010350EG	179521	9-2	ADKE3	585400	11-44	C25H3000PG	310241	11-4
4010400EG	179426	9-2	ADKE4	313303	11-44	C25H4000PG	310283	11-4
4010500EG	179427	9-2	AF14	179860	5-9	C25H6000HD	310291	11-4

F. Index – Part Number / Article Number

Part Number	Article Number	Page	Part Number	Article Number	Page	Part Number	Article Number	Page
C25H6000PG	310255	11-4	CAT16HP	181061	4-2	CATHPS4	181068	4-15
C25H6000S6	310265	11-4	CAT16HP24	181213	4-6	CATHPTM	181069	4-15
C28EC	337640	1-21	CAT16HP24SM	181098	4-5	CATHPVF14	181081	4-12
C28ES	337040	1-23	CAT16HP4Z34	181217	4-7	CATMTLS	181995	4-19
C28EU	337340	1-22	CAT16HP58	181001	4-6	CC25H0400HD	330210	11-5
C28GW	337840	1-24	CAT16HP58SM	181151	4-5	CC25H0500HD	330220	11-5
C30HD	336110	1-26	CAT16HPAB	181209	4-9	CC25H0600HD	330230	11-5
C30S4	336140	1-26	CAT16HPBC	181201	4-3	CC25H3000PG	310061	11-5
C32EC	337650	1-21	CAT16HPBCB	181219	4-4	CC25H6000HD	310111	11-5
C32ES	337050	1-23	CAT16HPGBSF	180811	4-8	CC25H6000PG	310071	11-5
C32EU	337350	1-22	CAT16HPTS	181089	4-10	CCC0037	598883	9-31
C32GW	337850	1-24	CAT21HP	181188	4-2	CCC0050	598884	9-31
C36EC	337660	1-21	CAT21HP24SM	181197	4-5	CCC0062	598886	9-31
C36ES	337060	1-23	CAT21HP4Z34	181258	4-7	CCC0075	598888	9-31
C36EU	337360	1-22	CAT21HP58SM	181198	4-5	CCC0087	598891	9-31
C36GW	337860	1-24	CAT21HPAB	181189	4-9	CCC0100	598892	9-31
C40EC	337670	1-21	CAT21HPBC	181238	4-3	CCC0112	598894	9-31
C40ES	337070	1-23	CAT21HPBCB	181245	4-4	CCC0125	598895	9-31
C40EU	337370	1-22	CAT32HP	181062	4-2	CCC0162	598899	9-31
C40GW	337870	1-24	CAT32HP24	181214	4-6	CCC0187	598903	9-31
C44EC	337680	1-21	CAT32HP24SM	181099	4-5	CCC0212	598906	9-31
C44ES	337080	1-23	CAT32HP4Z34	181218	4-7	CCC0237	598908	9-31
C44EU	337380	1-22	CAT32HP58	181002	4-6	CCC0450	598957	9-31
C45HD	336120	1-26	CAT32HP6Z34	181008	4-7	CD1B	181190	1-20
C45S4	336150	1-26	CAT32HPAB	181211	4-9	CE015H0180EG	599885	11-49
C48EC	337690	1-21	CAT32HPBC	181202	4-3	CE015H0240EG	599890	11-49
C48ES	337090	1-23	CAT32HPBCB	181221	4-4	CE015H0300EG	599900	11-49
C48EU	337390	1-22	CAT32HPGBSF	180821	4-8	CE015H0360EG	599905	11-49
C48GW	337890	1-24	CAT425	181130	4-17	CE015H0420EG	599910	11-49
C52EC	337700	1-21	CAT425WM	181880	4-18	CE015H0540EG	599920	11-49
C52ES	337100	1-23	CAT48HP	181063	4-2	CE015H0660EG	599925	11-49
C52EU	337400	1-22	CAT48HP24	181215	4-6	CE015H0780EG	599930	11-49
C56EC	337710	1-21	CAT48HP58	181231	4-6	CE0L13H0180EG	599879	11-49
C56ES	337110	1-23	CAT48HP58SM	181157	4-5	CE0L13H0300EG	599880	11-49
C56EU	337410	1-22	CAT48HP912	181232	4-6	CE224H0200EG	597500	11-50
C60EC	337720	1-21	CAT48HPAB	181212	4-9	CE224H0300EG	597510	11-50
C60ES	337120	1-23	CAT48HPBC	181203	4-3	CE320H0250EG	585860	11-50
C60EU	337420	1-22	CAT48HPBCB	181222	4-4	CE320H0500EG	585870	11-50
C64EC	337730	1-21	CAT64HP	181064	4-2	CE320H0750EG	585880	11-50
C64ES	337130	1-23	CAT64HP24	181216	4-6	CE420H0200EG	599935	11-51
C64EU	337430	1-22	CAT64HP58	181003	4-6	CE420H0300EG	599950	11-51
C70EC	337740	1-21	CAT64HP58SM	181161	4-5	CE420H0350EG	599960	11-51
C70ES	337140	1-23	CAT64HP912	181006	4-6	CE420H0450EG	599970	11-51
C70EU	337440	1-22	CAT64HPAB	181024	4-9	CE420H0550EG	599980	11-51
C76EC	337750	1-21	CAT64HPBCB	181021	4-4	CE420H0650EG	599990	11-51
C76ES	337150	1-23	CATHP24	181091	4-12	CE420H0800EG	599995	11-51
C76EU	337450	1-22	CATHP4Z34	181083	4-13	CE4SBEG	400046	11-52
C82EC	337760	1-21	CATHP58	181071	4-12	CE4SCEG	400047	11-51
C82ES	337160	1-23	CATHP6Z34	181084	4-13	CFEB05	195864	7-33
C82EU	337460	1-22	CATHP912	181072	4-12	CFH1060	593220	5-49
C88EC	337770	1-21	CATHPA4	181066	4-14	CFH838	593210	5-49
C94EC	337780	1-21	CATHPA6	181067	4-14	CFIXM10	584520	11-44
CAM10040	593200	5-47	CATHPAN	181065	4-14	CFIXM10040	584560	11-45
CAM10040S6	401155	5-47	CATHPBC	181078	4-11	CFIXM8	584510	11-44
CAM12050	400415	5-47	CATHPBC200	181079	4-10	CFIXM8030	584530	11-45
CAM6030	593180	5-47	CATHPBCB	181073	4-11	CFIXM8040	584540	11-45
CAM8030	593190	5-47	CATHPCD1B	181086	4-14	CFIXM8060	584550	11-45
CAM8030S6	401154	5-47	CATHPCD2.5B	181088	4-14	CHK22K	385860	2-3
CAM8040	593195	5-47	CATHPESC	181082	4-13	CHK25K	385870	2-3
CAT100CM	181976	4-17	CATHPLR	181093	4-16	CHK27K	385880	2-3

F. Index – Part Number / Article Number

Part Number	Article Number	Page	Part Number	Article Number	Page	Part Number	Article Number	Page
CHK30K	385890	2-3	CSB36CBLSS	402512	10-16	CSBURC12SS	402523	10-17
CHK32K	385900	2-3	CSB36SLVB	402196	10-16	CSBURC38	402198	10-17
CHN13K	386780	2-3	CSB36SLVBSS	402516	10-16	CSBURC38SS	402522	10-17
CHN13KSP	591410	2-3	CSBBARJEG	404354	10-4	CSBURC58	402200	10-17
CHN15K	385910	2-3	CSBBARJSB50EG	402502	10-8	CSBURC58SS	402564	10-17
CHN15KS4	591500	2-3	CSBBC075EG	404350	10-6	CSBURCR12	402202	10-17
CHN17K	385920	2-3	CSBBRP0100EG	404477	10-20	CSBURCR38	402201	10-17
CHN17KS4	591510	2-3	CSBBRP0125EG	404478	10-20	CSBURCR58	402203	10-17
CJ6	176830	3-2	CSBBRP0150EG	404479	10-20	CT	170450	5-42
CJ6S	160880	3-3	CSBBRP0200EG	404480	10-20	CTRI120HD	311920	11-16
CL3000PS	313310	11-7	CSBBRS1MEG	402239	10-20	CTRI160HD	311925	11-16
CLM10040	593110	5-49	CSBBRS2MEG	402240	10-21	CTRI210HD	311930	11-16
CLM6030	593090	5-49	CSBBRS3MEG	402241	10-21	CTRI260HD	311935	11-16
CLM8040	593100	5-49	CSBBS121836	-	10-19	CTRI310HD	311940	11-16
CNM6	336160	1-27	CSBC48	402536	10-18	CTRI410HD	311945	11-16
CNM6S4	336180	1-27	CSBIB075085EG	404365	10-5	CTRI510HD	311950	11-16
CNM8	336170	1-27	CSBIB075145EG	404366	10-5	CTRI810HD	311955	11-16
CNM8S4	336190	1-27	CSBIB125180EG	404367	10-5	CTS1	171600	5-42
CR037HD	336300	1-25	CSBIBSB50EG	402501	10-8	CUCS0250HD	312110	11-57
CR037S4	336400	1-25	CSBIBSN37EG	402500	10-9	CUCS0300HD	312120	11-57
CR050HD	336310	1-25	CSBMA050050EG	404371	10-7	CUCS0400HD	312140	11-57
CR050S4	336410	1-25	CSBMA050075EG	404372	10-7	CUCS0500HD	312160	11-57
CR075HD	336320	1-25	CSBNPC12	402208	10-18	CUCS0600HD	312170	11-57
CR075S4	336420	1-25	CSBNPC38	402528	10-18	CUCS0800HD	312180	11-57
CR087HD	336322	1-25	CSBNPC58	402529	10-18	CUCS1000HD	312190	11-57
CR100HD	336330	1-25	CSBQG0250MEG	404475	10-14	CUCS1300HD	312195	11-57
CR100S4	336430	1-25	CSBQG0300EG	404469	10-14	D1	336280	5-8
CR125HD	336340	1-25	CSBQG0400EG	404470	10-14	D25H3000PG	310630	11-5
CR125S4	336440	1-25	CSBQG0600EG	404472	10-14	D25H6000PG	310635	11-5
CR150HD	336350	1-25	CSBQG0800EG	404473	10-14	DD25H6000PG	310650	11-6
CR150S4	336450	1-25	CSBQIKCL0100EG	404373	10-12	DHM0100EG	598984	9-5
CR200HD	336360	1-25	CSBQIKCL0125EG	404374	10-12	DHM0125EG	598985	9-5
CR200S4	336460	1-25	CSBQIKCL0150EG	404375	10-12	DHM0150EG	598994	9-5
CRLAKITA	-	6-6	CSBQIKCL0200EG	404376	10-12	DHM0200EG	598995	9-5
CRLAM10EG	390010	6-6	CSBQIKCLSN37EG	402505	10-9	DIN021HD	400197	9-20
CRLAM8EG	390009	6-6	CSBRS1	402207	10-22	DIN021PL	400149	9-20
CRLBM10EG	390002	6-5	CSBRS2	404538	10-22	DIN027HD	400199	9-20
CRLBM8EG	390001	6-5	CSBRS3	404539	10-22	DIN027PL	400151	9-20
CRLLM10EG	390012	6-7	CSBRS37EG	404467	10-22	DIN034HD	400201	9-20
CRLP1M10L550	390035	6-8	CSBSH00375EG	404463	10-7	DIN034PL	400153	9-20
CRLP1M10L750	390036	6-8	CSBSH00500EG	404464	10-7	DIN042HD	400203	9-20
CRLP1M8L550	390029	6-8	CSBSH00625EG	404465	10-7	DIN042PL	400155	9-20
CRLP1M8L750	390030	6-8	CSBSH00750EG	404466	10-7	DIN048HD	400205	9-20
CRLP2M10L1050	390040	6-8	CSBSTU0100EG	404385	10-10	DIN048PL	400157	9-20
CRLP2M10L550	390037	6-8	CSBSTU0125EG	404386	10-10	DIN060HD	400208	9-20
CRLP2M10L750	390038	6-8	CSBSTU0150EG	404387	10-10	DIN060PL	400160	9-20
CRLP2M10L950	390039	6-8	CSBSTU0200EG	404388	10-10	DIN076HD	400210	9-20
CRLSM10EG	390004	6-10	CSBSTU0250EG	404389	10-10	DIN076PL	400162	9-20
CRLSM8EG	390003	6-10	CSBSTU0300EG	404390	10-10	DIN089HD	400212	9-20
CSB12CBL	402190	10-16	CSBSTU0400EG	404391	10-10	DIN089PL	400164	9-20
CSB12CBLSS	402510	10-16	CSBSTU0500EG	404392	10-10	DIN102HD	400214	9-20
CSB12SBHS	404461	10-19	CSBSTU0600EG	404393	10-10	DIN102PL	400166	9-20
CSB12SLVB	402194	10-16	CSBSTU0800EG	404394	10-10	DIN114HD	400216	9-20
CSB12SLVBSS	402514	10-16	CSBSTU1000EG	404395	10-10	DIN114PL	400168	9-20
CSB18CBL	402191	10-16	CSBT1	404300	10-15	DIN140HD	400219	9-20
CSB18CBLSS	402511	10-16	CSBT2	404301	10-15	DIN140PL	400171	9-20
CSB18SLVB	402195	10-16	CSBUNIV050EG	404407	10-8	DIN168HD	400222	9-20
CSB18SLVBSS	402515	10-16	CSBUNIV075EG	404409	10-8	DIN168PL	400174	9-20
CSB3346SB	402209	10-19	CSBUNIVSB62EG	402503	10-8	DIN219HD	400225	9-20
CSB36CBL	402192	10-16	CSBURC12	402199	10-17	DIN219PL	400177	9-20

F. Index – Part Number / Article Number

Part Number	Article Number	Page	Part Number	Article Number	Page	Part Number	Article Number	Page
DIN273HD	400229	9-20	EBC20M	172600	1-6	ESSUH	599501	9-56
DIN273PL	400181	9-20	EBC20MSM	172670	1-6	ESSUHS	599500	9-55
DIN323HD	400233	9-20	EBC24M	172610	1-6	ETP050	583550	5-32
DIN323PL	400185	9-20	EBC24MSM	172680	1-6	ETP100	583570	5-32
DIN355HD	400234	9-20	EBC32M	172620	1-6	EYEBH5065EG	574310	5-39
DIN355PL	400186	9-20	EBC32MSM	172690	1-6	EYEBH6075EG	574320	5-39
DIN406HD	400236	9-20	EBC6M	172580	1-6	EYEBH6100EG	574340	5-39
DIN406PL	400188	9-20	EBC6MSM	172650	1-6	EYEBH6150EG	574360	5-39
DIN457HD	400238	9-20	EBC812M	160200	1-6	EYESM10EG	574270	5-40
DIN457PL	400190	9-20	EBC812MSM	160180	1-6	EYESM6EG	574250	5-40
DIN508HD	400239	9-20	EBCM6MA	172990	5-14	EYESM8EG	574260	5-40
DIN508PL	400191	9-20	EBCM8MA	173000	5-14	EZR0250	179231	9-29
DIN610HD	400241	9-20	EBCSP25	172430	5-3	EZR0300	179232	9-29
DIN610PL	400193	9-20	EBL250A90	584666	11-53	EZR0350	179233	9-29
DPS025	400676	9-36	EBL25A135	584668	11-53	EZR0400	179234	9-29
DUPLON15EG	596040	9-28	EBL35A090	587510	11-53	EZR0600	179236	9-29
DUPLON22EG	596041	9-28	EBL35A135	587520	11-53	FCS0075M10	597968	9-6
DUPLON28EG	596042	9-28	EBS25A090	584660	11-52	FCS0075M8	597962	9-6
E015H2000PG	599997	11-41	EBS35A090	587530	11-52	FCS0100M10	597969	9-6
E01CNM10	315350	11-47	ECNUNIO6	585430	11-46	FCS0100M8	597963	9-6
E01CNM6	315370	11-47	ECNUNIO8	585440	11-46	FCS0125M10	597971	9-6
E01CNM8	315340	11-47	ECNUNIO10	585450	11-46	FCS0125M8	597964	9-6
E0L13H2000PG	599996	11-41	EE25H6000PG	310620	11-6	FCS0150M10	597972	9-6
E120H2000PG	585500	11-41	EER	171470	5-22	FCS0150M8	597965	9-6
E12H1000PG	310600	11-6	EERTIM10	173140	5-22	FCS0200M10	597973	9-6
E23CNM10	585270	11-47	EERTIM6	173120	5-22	FCS0200M8	597966	9-6
E23CNM6	585250	11-47	EERTIM8	173130	5-22	FCS0250M10	597974	9-6
E23CNM8	585260	11-47	EM1318	170075	5-11	FCS0300M10	597975	9-6
E25H6000PG	310605	11-6	EM1318SM	171855	5-12	FCS0400M10	597976	9-6
E2L15H2000PG	585480	11-42	EM24	170050	5-11	FCS0500M12	597977	9-6
E320H2000PG	585560	11-42	EM24R5	191026	5-11	FCS0600M12	597978	9-6
E320H3000PG	585550	11-42	EM24S1	179720	5-11	FCS0800M16	597979	9-6
E420H2000PG	599998	11-43	EM24SM	170530	5-12	FCS1000M20	597981	9-6
E420H3000PG	600000	11-43	EM24SM16	160440	5-12	FCSNUT10L	598153	9-7
E420H6000PG	599999	11-43	EM24SM16SP10	172220	5-12	FCSNUT10S	598152	9-7
E4CNM10	315360	11-47	EM24SP25	172170	5-11	FCSNUT12	598154	9-7
E4CNM8	315330	11-47	EM24SS1	179750	5-12	FCSNUT16	598155	9-7
E530H0300HD	335500	11-43	EM58	170060	5-11	FCSNUT20	598156	9-7
E530H0400HD	335510	11-43	EM58R5	191027	5-11	FCSNUT8	598151	9-7
E530H0400S4	335600	11-43	EM58S1	179730	5-11	FPN10	570730	5-52
E530H0500HD	335520	11-43	EM58SM	172060	5-12	FPN12	570740	5-52
E530H0600HD	335530	11-43	EM58SM16	160450	5-12	FPN6	570710	5-52
E530H0600S4	335620	11-43	EM58SM16R5	191044	5-12	FPN8	570720	5-52
E530H0800HD	335540	11-43	EM58SM16SP10	172230	5-12	FRF014	571130	9-34
E530H1000HD	335550	11-43	EM58SMS1	179760	5-12	FRF016	571140	9-34
E530H1000S4	335640	11-43	EM58SP25	172180	5-11	FRF016X2	571200	9-35
E530H2000HD	335560	11-43	EM912	170070	5-11	FRF018	571150	9-34
E530H2000S4	335650	11-43	EM912S1	179740	5-11	FRF018X2	571210	9-35
E530H3000HD	335570	11-43	EM912SM	171850	5-12	FRF020	571160	9-34
E530H3000S4	335660	11-43	EM912SM16	160460	5-12	FRF020X2	571220	9-35
E530H6000HD	335580	11-43	EM912SP25	175760	5-11	FRF022	571170	9-34
E530H6000S4	335670	11-43	EM912SS1	179770	5-12	FRF022X2	571230	9-35
E5CN10HD	335190	11-48	EQLS130	597792	9-51	FRF025	571180	9-34
E5CN6HD	335170	11-48	EQLS50	597791	9-51	FRF025X2	571240	9-35
E5CN6S4	335200	11-48	EQLS85	597780	9-51	FRF028	571190	9-34
E5CN8HD	335180	11-48	EQVS	597770	9-52	FRF028X2	571250	9-35
E5CN8S4	335210	11-48	EQZS	597790	9-51	FXB20S2	350100	9-52
EBC	170380	5-3	ESC4	174560	11-41	FXB21S2	350110	9-53
EBC16M	172590	1-6	ESG1	188470	3-5	FXB22S2	350120	9-53
EBC16MSM	172660	1-6	ESSST	599504	9-56	FXB23S2	350130	9-53

F. Index – Part Number / Article Number

Part Number	Article Number	Page	Part Number	Article Number	Page	Part Number	Article Number	Page
FXB24S2	350140	9-54	HDN094	577013	9-22	ISOF10M10EG	588580	9-57
FXB25S2	350150	9-54	HDN094HD	575013	9-23	ISOHD16EG	588500	9-58
FXBB10S2	591250	9-54	HDN102	577014	9-22	ISOSTRUT	335980	11-61
FXBB12S2	591260	9-54	HDN108	577015	9-22	ISSP	190800	11-38
FXBB16S2	591270	9-54	HDN116	577016	9-22	ITP050	588660	5-32
FXBB20S2	591280	9-54	HDN116HD	575016	9-23	ITP075	588670	5-32
FXBC10S2	591070	9-54	HDN129	577018	9-22	J1	170370	5-10
FXBC20S2	591080	9-54	HDN129HD	575018	9-23	J1CT	170610	1-16
FXBF10X50MS2	591200	9-55	HDN140	577019	9-22	J1M10TI	175050	5-17
FXBF12X50MS2	591210	9-55	HDN146	577020	9-22	J1M6QTI	174881	5-17
FXBF16X50MS2	591220	9-55	HDN146HD	575020	9-23	J1M6TI	174870	5-17
FXBF20X50MS2	591230	9-55	HDN155	577021	9-22	J1M8TI	174960	5-17
FXBTOOL	591290	9-55	HDN165	577022	9-22	J1T10	160220	5-17
GR50	172920	4-18	HDN165HD	575022	9-23	J2	171590	5-10
HB2	336030	5-4	HDN173	577023	9-22	J2CT	170350	1-16
HB2HD	336040	5-4	HDN173HD	575023	9-23	J2M10TI	175060	5-17
HDI018	577033	9-17	HDN182	577024	9-22	J2M6QTI	174882	5-17
HDI023	577034	9-17	HDN194	577025	9-22	J2M6TI	174880	5-17
HDI028	577035	9-17	HDN205	577026	9-22	J2M8TI	174970	5-17
HDI033	577036	9-17	HDN216	577027	9-22	J2T10	160230	5-17
HDI037	577037	9-17	HDN226	577028	9-22	K12	170670	1-17
HDI045	577038	9-17	HDN226HD	575028	9-23	K16	170680	1-17
HDI052	577039	9-17	HDN236	577029	9-22	K20	170690	1-17
HDI058	577040	9-17	HDN250	577030	9-22	KA25H0150EG	311707	11-14
HDI065	577041	9-17	HDN261	577031	9-22	KA25H0150HD	311702	11-14
HDI078	577043	9-17	HDN273	577032	9-22	KA25H0150S6	311693	11-14
HDI093	577045	9-17	HDN273HD	575032	9-23	KA25H0200EG	311708	11-14
HDI116	577048	9-17	HDN316	577068	9-22	KA25H0200HD	311703	11-14
HDI129	577050	9-17	HFRMHDW	360424	8-9	KA25H0300EG	311717	11-14
HDI137	577051	9-17	HK25	187440	1-7	KA25H0300HD	311713	11-14
HDI145	577052	9-17	HK48	187450	1-7	KA25H0300S6	311694	11-14
HDI154	577053	9-17	HK811	187460	1-7	KA25H0450EG	311728	11-14
HDI162	577054	9-17	HSC1011	186020	1-7	KA25H0450HD	311718	11-14
HDI171	577055	9-17	HSC1214	186030	1-7	KA25H0450S6	311695	11-14
HDI203	577058	9-17	HSC1518	186040	1-7	KA25H0500EG	311729	11-14
HDI214	577059	9-17	HSC1924	186050	1-7	KA25H0500HD	311732	11-14
HDI225	577061	9-17	HSC2532	186060	1-7	KA25H0600EG	311731	11-14
HDI250	577064	9-17	HSC67	186000	1-7	KA25H0600HD	311733	11-14
HDI273	577066	9-17	HSC78	187740	1-7	KA25H0600S6	311696	11-14
HDI316	577067	9-17	HSC89	186010	1-7	KA25H0750EG	311756	11-14
HDN019	577001	9-22	HSC910	187780	1-7	KA25H0750HD	311757	11-14
HDN019HD	575001	9-23	HSCRM1025HD	593745	5-36	KA25H1000HD	311758	11-14
HDN024	577002	9-22	HSCRM1030HD	593755	5-36	KA25H1200HD	311759	11-14
HDN024HD	575002	9-23	HSCRM1230HD	593765	5-36	KA25H1500HD	311760	11-14
HDN030	577003	9-22	HSCRM825EG	593680	5-36	KA25H2000HD	311761	11-14
HDN030HD	575003	9-23	HW10	187290	5-24	KAA25H0300HD	311401	11-15
HDN035	577004	9-22	HW10SR	188820	5-24	KAA25H0500HD	311419	11-15
HDN035HD	575004	9-23	HW12	187300	5-24	KAA25H0750HD	311431	11-15
HDN041	577005	9-22	HW6	187270	5-24	KAA25H1050HD	311451	11-15
HDN045	577006	9-22	HW6M	188740	5-24	KBT	170011	1-27
HDN045HD	575006	9-23	HW8	187280	5-24	KC25H0150EG	311657	11-15
HDN053	577007	9-22	HW8M	188780	5-24	KC25H0150HD	311649	11-15
HDN053HD	575007	9-23	IDSM16	173460	2-5	KC25H0300EG	311667	11-15
HDN059	577008	9-22	IGBSF	182052	4-22	KC25H0300HD	311659	11-15
HDN059HD	575008	9-23	IHT20	578680	9-58	KC25H0450EG	311677	11-15
HDN065	577009	9-22	IHT30	578695	9-58	KC25H0450HD	311669	11-15
HDN065HD	575009	9-23	INC8	336290	11-32	KCC25H0300HD	311805	11-16
HDN072	577010	9-22	ISOE01	400914	11-61	KCC25H0450HD	311815	11-16
HDN081	577011	9-22	ISOF08F08EG	588440	9-56	KCC25H0600HD	311825	11-16
HDN081HD	575011	9-23	ISOF08M08EG	588560	9-57	KIT600	590010	11-60

F. Index – Part Number / Article Number

Part Number	Article Number	Page	Part Number	Article Number	Page	Part Number	Article Number	Page
KIT600ISO	589990	11-60	MDS023	400661	9-19	MFE068	586209	9-9
KN30EG	380050	2-4	MDS028	400662	9-19	MFN019EG	586101	9-25
KN40EG	380060	2-4	MDS035	400663	9-19	MFN019S6	586401	9-26
KN50EG	380070	2-4	MDS043	400664	9-19	MFN023EG	586102	9-25
KP2708020	590074	11-45	MFAM6	160310	11-13	MFN023S6	586402	9-26
KP2708030	590076	11-45	MFD015	586001	9-10	MFN029EG	586103	9-25
KP2708040	590077	11-45	MFD015S6	586301	9-11	MFN029S6	586403	9-26
KP2708080	590082	11-45	MFD019	586002	9-10	MFN035EG	586104	9-25
KP2710030	590087	11-45	MFD019S6	586302	9-11	MFN035S6	586404	9-26
KP3408030	585050	11-46	MFD025	586003	9-10	MFN041EG	586105	9-25
KP3408050	585060	11-46	MFD025S6	586303	9-11	MFN041S6	586405	9-26
KP3408060	585010	11-46	MFD031	586004	9-10	MFN048EG	586106	9-25
KP3808025	590201	11-46	MFD031S6	586304	9-11	MFN048S6	586406	9-26
KP3808040	590210	11-46	MFD037	586005	9-10	MFN054EG	586107	9-25
KP3810035	590207	11-46	MFD037S6	586305	9-11	MFN054S6	586407	9-26
KP3810050	590330	11-46	MFD044	586006	9-10	MFN062EG	586108	9-25
LAM1040	574420	5-48	MFD044S6	586306	9-11	MFN062S6	586408	9-26
LAM1250	574430	5-48	MFD050	586007	9-10	MFN072EG	586109	9-25
LAM625	589890	5-48	MFD050S6	586307	9-11	MFN072S6	586409	9-26
LAM830	574410	5-48	MFD058	586008	9-10	MFN083EG	586110	9-25
LB3B	187390	1-8	MFD058S6	586308	9-11	MFN083S6	586410	9-26
LF2	187400	1-8	MFD068	586009	9-10	MFN093EG	586111	9-25
LF3	187410	1-8	MFD068S6	586309	9-11	MFN093S6	586411	9-26
LF5	187430	1-8	MFD078	586010	9-10	MFN103EG	586112	9-25
LLSH6X30	401129	5-40	MFD078S6	586310	9-11	MFN103S6	586412	9-26
LLSM8X30	401126	5-40	MFD088	586011	9-10	MFN113EG	586113	9-25
LR1	187370	1-9	MFD088S6	586311	9-11	MFN113S6	586413	9-26
LR2	187380	1-9	MFD098	586012	9-10	MFN123EG	586114	9-25
M10GTD1217	160340	5-23	MFD098S6	586312	9-11	MFN123S6	586414	9-26
M10GTD1722	160370	5-23	MFD108	586013	9-10	MFN133EG	586115	9-25
M10TI	170910	5-26	MFD108S6	586313	9-11	MFN133S6	586415	9-26
M10TI24	175000	5-15	MFD118	586014	9-10	MFN143EG	586116	9-25
M10TI4	174990	5-15	MFD118S6	586314	9-11	MFN143S6	586416	9-26
M10TI58	175010	5-15	MFD128	586015	9-10	MFN153EG	586117	9-25
M10TI912	175020	5-15	MFD128S6	586315	9-11	MFN153S6	586417	9-26
M10TIB	175030	5-27	MFD138	586016	9-10	MFN165EG	586118	9-25
M10TIBGBSF	170916	5-28	MFD138S6	586316	9-11	MFN165S6	586418	9-26
M10VKR	160660	5-22	MFD148	586017	9-10	MFN175EG	586119	9-25
M6TI	174800	5-26	MFD148S6	586317	9-11	MFN175S6	586419	9-26
M6TI24	174820	5-15	MFD160	586018	9-10	MFN205EG	586120	9-25
M6TI24R5	191024	5-15	MFD160S6	586318	9-11	MFN205S6	586420	9-26
M6TI4	174810	5-15	MFD170	586019	9-10	MFN220EG	586121	9-25
M6TI58	174830	5-15	MFD170S6	586319	9-11	MFN220S6	586421	9-26
M6TI912	174840	5-15	MFD200	586020	9-10	MFN230EG	586122	9-25
M6TIB	174850	5-27	MFD200S6	586320	9-11	MFN230S6	586422	9-26
M6VKR	160640	5-22	MFD215	586021	9-10	MFN255EG	586123	9-25
M8TI	170900	5-26	MFD215S6	586321	9-11	MFN280EG	586124	9-25
M8TI24	174910	5-15	MFD225	586022	9-10	MFN324EG	586125	9-25
M8TI4	174900	5-15	MFD225S6	586322	9-11	MFSE	160991	3-2
M8TI58	174920	5-15	MFD250	586023	9-10	MFT1	571520	5-50
M8TI912	174930	5-15	MFD275	586024	9-10	MFT2	571530	5-50
M8TIB	174940	5-27	MFD319	586025	9-10	MFV433	571460	5-49
M8TIBGBSF	170906	5-28	MFE015	586201	9-9	MFV537	571470	5-49
M8VKR	160650	5-22	MFE019	586202	9-9	MFV650	571510	5-49
MDC019	596000	9-19	MFE025	586203	9-9	MFVI0080EG	586601	9-47
MDC023	596010	9-19	MFE031	586204	9-9	MFVI0090EG	586602	9-47
MDC028	596020	9-19	MFE037	586205	9-9	MFVI0100EG	586603	9-47
MDC035	596030	9-19	MFE044	586206	9-9	MFVI0112EG	586604	9-47
MDS015	400659	9-19	MFE050	586207	9-9	MFVI0125EG	586605	9-47
MDS019	400660	9-19	MFE058	586208	9-9	MFVI0140EG	586606	9-47

F. Index – Part Number / Article Number

Part Number	Article Number	Page	Part Number	Article Number	Page	Part Number	Article Number	Page
MFVI0150EG	586607	9-47	MPD067	400087	9-12	MTVB8100	584455	5-54
MFVI0160EG	586608	9-47	MPD073	400088	9-12	MTVB8200	584456	5-54
MFVI0180EG	586609	9-47	MPD080	400089	9-12	MXOVDN1012EG	401161	9-29
MFVI0200EG	586610	9-47	MPD091	400090	9-12	MXOVDN1215EG	401244	9-29
MFVI0224EG	586611	9-47	MPD106	400091	9-12	MXOVDN1618EG	401245	9-29
MFVI0250EG	586612	9-47	MPD114	400092	9-12	MXOVDN20EG	401246	9-29
MFVI0280EG	586613	9-47	MPD116	400093	9-12	MXOVDN25EG	403800	9-29
MFVI0300EG	586614	9-47	MPD127	400094	9-12	MXZ018	403600	9-27
MFVI0315EG	586615	9-47	MPD135	400095	9-12	MXZ026	403605	9-27
MFVI0355EG	586616	9-47	MPD139	400096	9-12	MXZ030	403610	9-27
MFVI0400EG	586617	9-47	MPD144	400097	9-12	MXZ040	403615	9-27
MFVI0450EG	586618	9-47	MPD163	400098	9-12	MXZ047	403620	9-27
MFVI0500EG	586619	9-47	MPD169	400099	9-12	MXZ054	403625	9-27
MFVI0560EG	586620	9-47	MPD200	400100	9-12	MXZ062	403630	9-27
MFVI0600EG	586621	9-47	MPD212	400101	9-12	MXZ069	403635	9-27
MFVI0630EG	586622	9-47	MPE4	400916	11-55	MXZ078	403645	9-27
MFVI0710EG	586623	9-47	MPK028	401903	9-13	MXZ084	403650	9-27
MFVI0800EG	586624	9-47	MPK035	401904	9-13	MXZ091	403655	9-27
MFVI0900EG	586625	9-47	MPK043	401905	9-13	MXZ098	403660	9-27
MFVI1000EG	586626	9-47	MPK049	401906	9-13	MXZ107	403665	9-27
MFVI1120EG	586627	9-47	MPK056	401907	9-13	MXZ110	403670	9-27
MFVI1250EG	586628	9-47	MPK061	401908	9-13	MXZ116	403675	9-27
MFVN0080EG	586501	9-48	MPK080	401911	9-13	MXZ126	403680	9-27
MFVN0090EG	586502	9-48	MPK091	401912	9-13	MXZ141	403690	9-27
MFVN0100EG	586503	9-48	MPK114	401914	9-13	MXZ154	403695	9-27
MFVN0112EG	586504	9-48	MPK139	401918	9-13	MXZ168	403705	9-27
MFVN0125EG	586505	9-48	MPK163	401920	9-13	MXZ184	403715	9-27
MFVN0140EG	586506	9-48	MPK169	401921	9-13	MXZ195	403720	9-27
MFVN0150EG	586507	9-48	MPK200	401922	9-13	MXZ218	403730	9-27
MFVN0160EG	586508	9-48	MPL016	595035	9-14	N6T5X10L49	402601	5-46
MFVN0180EG	586509	9-48	MPL020	595036	9-14	NAIL04X14	400426	5-41
MFVN0200EG	586510	9-48	MPL025	595037	9-14	NAIL04X18	400427	5-41
MFVN0224EG	586511	9-48	MPL032	595038	9-14	NAILTOOL	400428	5-41
MFVN0250EG	586512	9-48	MPL040	595039	9-14	NPN640	570800	5-51
MFVN0280EG	586513	9-48	MPL050	595040	9-14	NPN660	570810	5-51
MFVN0300EG	586514	9-48	MPL063	595042	9-14	NPN680	570820	5-51
MFVN0315EG	586515	9-48	MPL075	595043	9-14	NPN860	570830	5-51
MFVN0355EG	586516	9-48	MPL090	595044	9-14	NUTFLM10	597983	9-7
MFVN0400EG	586517	9-48	MPL110	595045	9-14	NUTFLM8	597982	9-7
MFVN0450EG	586518	9-48	MPL125	595046	9-14	NUTM10EG	315025	11-9
MFVN0500EG	586519	9-48	MPL140	595047	9-14	NUTM10HD	315020	11-9
MFVN0560EG	586520	9-48	MPL160	595048	9-14	NUTM10S6	315160	11-9
MFVN0600EG	586521	9-48	MPZ020	595052	9-28	NUTM12EG	315035	11-9
MFVN0630EG	586522	9-48	MPZ025	595053	9-28	NUTM12HD	315030	11-9
MFVN0710EG	586523	9-48	MPZ032	595054	9-28	NUTM12S6	315170	11-9
MFVN0800EG	586524	9-48	MPZ040	595056	9-28	NUTM12THD	315031	11-9
MFVN0900EG	586525	9-48	MPZ050	595057	9-28	NUTM16EG	315036	11-9
MFVN1000EG	586526	9-48	MPZ063	595059	9-28	NUTM16HD	315037	11-9
MFVN1120EG	586527	9-48	MPZ075	595061	9-28	NUTM6EG	314995	11-9
MFVN1250EG	586528	9-48	MPZ090	595062	9-28	NUTM6HD	315000	11-9
MLT2HS6	188100	5-42	MPZ110	595063	9-28	NUTM6S6	315140	11-9
MPD014	400078	9-12	MSF	179965	3-2	NUTM8EG	315015	11-9
MPD019	400079	9-12	MSP20	188480	3-5	NUTM8HD	315010	11-9
MPD023	400080	9-12	MSS24	172030	9-49	NUTM8S6	315150	11-9
MPD028	400081	9-12	MSS58	171760	9-49	OCD C68MM	160700	5-23
MPD035	400082	9-12	MSS912	171770	9-49	OCDCTIM6	160710	5-23
MPD043	400083	9-12	MTSB4	584410	5-53	OCDCTIM8	160720	5-23
MPD049	400084	9-12	MTSH4	584430	5-53	OSM10X30	336060	5-41
MPD056	400085	9-12	MTVB10100	584465	5-54	OSM8X25	336050	5-41
MPD061	400086	9-12	MTVB10200	584466	5-54	PBRM10L120	587160	5-25

F. Index – Part Number / Article Number

Part Number	Article Number	Page	Part Number	Article Number	Page	Part Number	Article Number	Page
PBRM10L80	587135	5-25	PSA16AH18	360469	8-5	PXI151S6	578480	9-18
PBRM12L120	587165	5-25	PSB24A	360475	8-5	PXI164S6	578500	9-18
PBRM8M10L120	587140	5-25	PSB30A	360476	8-5	PXI170EG	578120	9-18
PBRM8M10L70S6	587175	5-25	PSB36A	360477	8-5	PXI170S6	578510	9-18
PBRM8M10L80	587145	5-25	PSB42A	360478	8-5	PXI180S6	578520	9-18
PBT050L120	587120	5-25	PSB48A	360479	8-5	PXI194S6	578540	9-18
PBT050L80	587125	5-25	PSB60A	360480	8-5	PXI201S6	578550	9-18
PBU10M	360496	8-13	PSF10C	360464	8-4	PXI220EG	578180	9-18
PBU16M	360497	8-13	PSF10D	360465	8-4	PXI220S6	578570	9-18
PBU6M	360495	8-13	PSF16C	360466	8-4	PXN025EG	577060	9-24
PCG	588170	9-44	PSF16D	360467	8-4	PXN025S6	577460	9-24
PCS1	170880	1-18	PSF6C	360463	8-4	PXN031EG	577070	9-24
PCS2	170881	1-18	PTB6	172921	4-18	PXN031S6	577470	9-24
PEB	360425	8-11	PTB8	172922	4-18	PXN036EG	577080	9-24
PEC	360428	8-12	PTC050EG	578730	5-33	PXN036S6	577480	9-24
PEH31	360494	8-11	PTC050S6	578800	5-33	PXN046EG	577100	9-24
PEK4B	360426	8-9	PTF10	360461	8-14	PXN046S6	577500	9-24
PEK6B	360427	8-10	PTF10P	360519	8-15	PXN052EG	577110	9-24
PEKEF	360493	8-10	PTF16	360462	8-14	PXN052S6	577510	9-24
PESHO	580564	9-40	PTF16P	360522	8-15	PXN063EG	577130	9-24
PESHOS	580565	9-40	PTF1C	360484	8-14	PXN063S6	577530	9-24
PESHT	580566	9-41	PTF2C	360485	8-14	PXN073EG	577150	9-24
PESHTS	580567	9-41	PTF6	360460	8-14	PXN079EG	577160	9-24
PESMO	580560	9-42	PTF6P	360518	8-15	PXN079S6	577560	9-24
PESMOS	580561	9-42	PTFP	360521	8-15	PXN086S6	577570	9-24
PESMT	580562	9-43	PW2	175590	5-10	PXN092EG	577180	9-24
PESMTS	580563	9-43	PW2M10TIIN	175620	5-18	PXN092S6	577580	9-24
PHB	360422	8-8	PW2M6TIIN	175600	5-18	PXN105S6	577600	9-24
PHBR	360423	8-8	PW2M8TIIN	175610	5-18	PXN117EG	577220	9-24
PHK	360420	8-8	PWM	571270	5-52	PXN117S6	577620	9-24
PHKR	360421	8-8	PWMS	571280	5-52	PXN129S6	577640	9-24
PHW8	188850	5-24	PWN	571290	5-52	PXN143EG	577260	9-24
PKM10H3	182044	4-21	PWNS	571300	5-52	PXN143S6	577660	9-24
PKM10H3GBSF	182053	4-22	PXI013S6	578250	9-18	PXN163S6	577690	9-24
PKM10H6	182045	4-21	PXI018EG	577870	9-18	PXN169EG	577300	9-24
PKM10H6IN	182048	4-20	PXI018S6	578260	9-18	PXN169S6	577700	9-24
PKM16H3	182046	4-21	PXI022EG	577880	9-18	PXN175S6	577710	9-24
PKM16H3GBSF	182054	4-22	PXI022S6	578270	9-18	PXN182S6	577720	9-24
PKM16H6	182047	4-21	PXI028EG	577890	9-18	PXN205S6	577750	9-24
PKM16H6IN	182049	4-20	PXI028S6	578280	9-18	PXN219EG	577370	9-24
PKMINSERT	182051	4-21	PXI034EG	577900	9-18	PXN219S6	577770	9-24
PLN10	589930	11-17	PXI034S6	578290	9-18	PXN252EG	577400	9-24
PLN10S6	589927	11-17	PXI045EG	577920	9-18	PXN252S6	577800	9-24
PLN11S6	589928	11-17	PXI045S6	578310	9-18	QSC	182058	4-19
PLN13	589940	11-17	PXI050EG	577930	9-18	QSC4	182059	4-19
PLN13HD	589949	11-17	PXI050S6	578320	9-18	QSNM10040EG	592922	11-8
PLN13S6	589921	11-17	PXI061EG	577950	9-18	QSNM10060EG	592924	11-8
PLN8	589925	11-17	PXI061S6	578340	9-18	QSNM10EG	592920	11-8
PLNE008	588240	11-52	PXI081EG	577980	9-18	QSNM12EG	592930	11-8
PLNE010	588250	11-52	PXI081S6	578370	9-18	QSNM6EG	592900	11-8
PLNE1208	588260	11-52	PXI093EG	578000	9-18	QSNM8040EG	592912	11-8
PLNE3408	588280	11-52	PXI093S6	578390	9-18	QSNM8060EG	592914	11-8
PLNE3410	588285	11-52	PXI099S6	578400	9-18	QSNM8EG	592910	11-8
PLUNI10	588290	11-52	PXI105S6	578410	9-18	RACE3	585780	11-55
PPRPS25H4	182450	8-16	PXI111S6	578420	9-18	RADTOP260EG	400810	9-44
PRA6H16	360474	8-7	PXI118EG	578040	9-18	RADTOP300EG	400812	9-44
PRF2	360470	8-6	PXI118S6	578430	9-18	RADTOP330EG	400813	9-44
PRF6	360472	8-6	PXI125S6	578440	9-18	RADTOPWS	400816	9-44
PRS6	360483	8-7	PXI145EG	578080	9-18	RET16B50	181271	4-16
PSA10CH13	360468	8-5	PXI145S6	578470	9-18	RET21B50	181272	4-16

F. Index – Part Number / Article Number

Part Number	Article Number	Page	Part Number	Article Number	Page	Part Number	Article Number	Page
RET32B50	181273	4-16	SCLI13I0022	580111	9-45	SL1518	195861	7-34
RET48B25	181274	4-16	SCLI13I0025	580112	9-45	SL6T	196850	7-8
RET64B25	181275	4-16	SCLI13I0027	580120	9-45	SLADCP	195851	7-32
RFFM10M12	583890	5-33	SCLI13I0028	580121	9-45	SLADS	195852	7-32
RFFM8M10	583870	5-33	SCLI13I0030	580122	9-45	SLBM12	196852	7-8
RFFM8M12	583880	5-33	SCLI13I0034	580130	9-45	SLC15L1000SP	196001	7-31
RMFM10M12	583760	5-34	SCLI13I0035	580135	9-45	SLC15L50MSP	196023	7-31
RMFM10M8	583750	5-34	SCLI13I0042	580140	9-45	SLC2L1000SP	196002	7-31
RMFM12M10	583780	5-34	SCLI13I0044	580145	9-45	SLC2L100SP	196022	7-31
RMFM12M8	583770	5-34	SCLI13I0049	580150	9-45	SLC3L1000SP	196003	7-31
RMFM6M8	583710	5-34	SCLI13I0054	580151	9-45	SLC6CTO	196819	7-6
RMFM8M10	583730	5-34	SCLI13I0057	580152	9-45	SLC6L50	196821	7-6
RMFM8M12	583740	5-34	SCLI13I0060	580160	9-45	SLD15L10S	195945	7-26
RMFM8M6	583720	5-34	SCLI13I0064	580170	9-45	SLD15L2S	195935	7-26
RPSE1H24	182365	8-13	SCLI13I0070	581600	9-45	SLD15L5S	195940	7-26
RPSE1H57	182370	8-13	SCLI13I0076	581610	9-45	SLD15QT250	196007	7-28
RPSE2H46	182375	8-13	SCLI13I0089	581620	9-45	SLD15Y500	195960	7-28
RPSE4H46	182380	8-13	SCLI13I0102	581630	9-45	SLD2Y500	176870	7-28
RTUM10	583590	5-34	SCLI13I0108	581640	9-45	SLD2YH500	196015	7-27
RTUM10L18	583610	5-34	SCLI13I0114	581650	9-45	SLD3YH800	195998	7-27
RTUM10L30	583630	5-34	SCLI19I0010	580270	9-45	SLDM615L1	196028	7-26
RTUM12L20	583620	5-34	SCLI19I0012	580280	9-45	SLDM615L2	196029	7-26
RTUM8	583580	5-34	SCLI19I0016	580290	9-45	SLDM615L2T	196044	7-27
RTUM8L15	583600	5-34	SCLI19I0017	580300	9-45	SLDW6	196822	7-6
S30EG	591570	2-4	SCLI19I0018	580305	9-45	SLEBM6	195854	7-33
S40EG	591580	2-4	SCLI19I0021	580310	9-45	SLEBM8	195856	7-33
S40EGSP25	172420	2-4	SCLI19I0022	580311	9-45	SLEBWS	195858	7-33
S40S4	591650	2-4	SCLI19I0025	580312	9-45	SLJR200	196008	7-31
S50EG	591590	2-4	SCLI19I0027	580320	9-46	SLK15L1	196508	7-14
S50S4	591660	2-4	SCLI19I0028	580321	9-46	SLK15L10	196513	7-14
SABM10010	400410	5-43	SCLI19I0030	580322	9-46	SLK15L10DW6	196835	7-7
SABM10010S6	401152	5-43	SCLI19I0034	580330	9-46	SLK15L10LP	196603	7-15
SABM10050	400411	5-43	SCLI19I0035	580335	9-46	SLK15L10T	196526	7-18
SABM10050S6	401153	5-43	SCLI19I0042	580340	9-46	SLK15L1AB	196500	7-9
SABM12015	402170	5-43	SCLI19I0044	580345	9-46	SLK15L1DH	196676	7-12
SABM12050	401158	5-43	SCLI19I0049	580350	9-46	SLK15L1DW6	196830	7-7
SABM16025	402171	5-43	SCLI19I0054	580351	9-46	SLK15L1LP	196601	7-15
SABM20030	402446	5-43	SCLI19I0057	580352	9-46	SLK15L1LPR2	196628	7-15
SABM8010	400408	5-43	SCLI19I0060	580360	9-46	SLK15L1SEM6	196564	7-16
SABM8010S6	401150	5-43	SCLI19I0064	580365	9-46	SLK15L1SEM8	196565	7-16
SABM8050	400409	5-43	SCLI19I0070	581660	9-46	SLK15L1SF	196517	7-10
SABM8050S6	401151	5-43	SCLI19I0076	581670	9-46	SLK15L1T	196521	7-18
SBFKM8	588620	9-57	SCLI19I0089	581680	9-46	SLK15L1WA6	196670	7-17
SBMKM10	588630	9-57	SCLI19I0102	581690	9-46	SLK15L2	196509	7-14
SBMKM8	588610	9-57	SCLI19I0108	581700	9-46	SLK15L2AB	196501	7-9
SBP17	400429	9-50	SCLI19I0114	581710	9-46	SLK15L2DH	196677	7-12
SBPC19	400430	9-51	SCLI19I0125	581715	9-46	SLK15L2DW6	196831	7-7
SCA	160510	1-11	SCLI19I0133	581720	9-46	SLK15L2GBSF	197812	7-11
SCB1220	188090	1-11	SCLI19I0139	581725	9-46	SLK15L2LP	196514	7-15
SCB312	188080	1-11	SCLI19I0160	581730	9-46	SLK15L2LPR2	196629	7-15
SCD1217	188170	1-11	SCLI19I0168	581735	9-46	SLK15L2R2	196614	7-14
SCD1217QSC	188175	1-16	SCMDSN	800070	5-51	SLK15L2SEM6	196566	7-16
SCD1722	188180	1-11	SCMND	800071	5-50	SLK15L2SEM8	196567	7-16
SCD1722QSC	188185	1-16	SCSOL1A	187781	1-9	SLK15L2SF	196518	7-10
SCLI13I0010	580091	9-45	SCT03	312198	5-26	SLK15L2T	196522	7-18
SCLI13I0012	580092	9-45	SHLGE03	584672	11-54	SLK15L2TR2	196644	7-18
SCLI13I0016	580093	9-45	SHLGE4	584673	11-54	SLK15L2WA6	196671	7-17
SCLI13I0017	580100	9-45	SHSGE03	584670	11-55	SLK15L3	196510	7-14
SCLI13I0018	580105	9-45	SHSGE4	584671	11-55	SLK15L34H24	196506	7-13
SCLI13I0021	580110	9-45	SL1214	195860	7-34	SLK15L34H58	196507	7-13

F. Index – Part Number / Article Number

Part Number	Article Number	Page	Part Number	Article Number	Page	Part Number	Article Number	Page
SLK15L3AB	196502	7-9	SLK2L3SF	196547	7-10	SLS2C50	196739	7-30
SLK15L3DH	196504	7-12	SLK2L3WA6	196735	7-17	SLS2L1	196741	7-22
SLK15L3DW6	196832	7-7	SLK2L5	196540	7-14	SLS2L10	196746	7-22
SLK15L3GBSF	197813	7-11	SLK2L5AB	196531	7-9	SLS2L2	196742	7-22
SLK15L3LP	196515	7-15	SLK2L5DH	196533	7-12	SLS2L2SEM8	196756	7-23
SLK15L3LPR2	196630	7-15	SLK2L5DW6	196839	7-7	SLS2L3	196743	7-22
SLK15L3R2	196615	7-14	SLK2L5LP	196545	7-15	SLS2L3DH	196753	7-21
SLK15L3SEM6	196568	7-16	SLK2L5SEM6	196562	7-16	SLS2L3SEM8	196757	7-23
SLK15L3SEM8	196570	7-16	SLK2L5SEM8	196563	7-16	SLS2L3WA6	196759	7-24
SLK15L3SF	196519	7-10	SLK2L5SF	196548	7-10	SLS2L5	196744	7-22
SLK15L3T	196523	7-18	SLK2L5WA6	196736	7-17	SLS2L5DH	196754	7-21
SLK15L3TR2	196645	7-18	SLK2L7	196541	7-14	SLS2L5WA6	196760	7-24
SLK15L3WA6	196672	7-17	SLK2L7DH	196534	7-12	SLS2L7	196745	7-22
SLK15L5	196511	7-14	SLK2L7DW6	196840	7-7	SLS2L7DH	196755	7-21
SLK15L500PACK	196045	7-29	SLK2L7LP	196605	7-15	SLS2L7WA6	196761	7-24
SLK15L50MPACK	196046	7-29	SLK2L7WA6	196737	7-17	SLS3C50	196740	7-30
SLK15L5AB	196503	7-9	SLK2Y300L7	196556	7-20	SLS3L1	196747	7-22
SLK15L5DH	196505	7-12	SLK2Y500L3	196554	7-20	SLS3L10	196752	7-22
SLK15L5DW6	196833	7-7	SLK2YH500L2	196549	7-19	SLS3L2	196748	7-22
SLK15L5LP	196516	7-15	SLK2YH500L3	196550	7-19	SLS3L3	196749	7-22
SLK15L5LPR2	196631	7-15	SLK2YH500L7	196551	7-19	SLS3L5	196750	7-22
SLK15L5R2	196616	7-14	SLK3C200	196730	7-30	SLS3L7	196751	7-22
SLK15L5SF	196520	7-10	SLK3L1	196700	7-14	SLWC	195853	7-31
SLK15L5T	196524	7-18	SLK3L10	196705	7-14	SLWC	195853	10-18
SLK15L5WA6	196673	7-17	SLK3L10AB	196716	7-9	SMS8	187197	3-5
SLK15L7	196512	7-14	SLK3L10DW6	196847	7-7	SNAEG	311905	11-36
SLK15L7DW6	196834	7-7	SLK3L10LP	196711	7-15	SNAHD	311900	11-36
SLK15L7LP	196602	7-15	SLK3L10SEM10	196721	7-16	SNM10	390007	6-10
SLK15L7T	196525	7-18	SLK3L10WA6	196727	7-17	SNM12	390008	6-10
SLK15PROMOPACK	196048	7-29	SLK3L1DW6	196842	7-7	SNM6	390005	6-10
SLK15Y300L3R2	196648	7-20	SLK3L1LP	196706	7-15	SNM8	390006	6-10
SLK15Y500L3	196528	7-20	SLK3L1WA6	196722	7-17	SNSWM10	390102	6-11
SLK2C200	196600	7-30	SLK3L2	196701	7-14	SNSWM8	390101	6-11
SLK2L1	196537	7-14	SLK3L2AB	196713	7-9	SOSR075	597805	9-38
SLK2L10	196542	7-14	SLK3L2DW6	196843	7-7	SOSR100	597806	9-38
SLK2L100PACK	196047	7-29	SLK3L2LP	196707	7-15	SOSR125	597807	9-38
SLK2L10DW6	196841	7-7	SLK3L2WA6	196723	7-17	SOSR150	597808	9-38
SLK2L10LP	196606	7-15	SLK3L3	196702	7-14	SOSR200	597809	9-38
SLK2L1DW6	196836	7-7	SLK3L3DW6	196844	7-7	SPPM6HD	336200	1-26
SLK2L1LP	196604	7-15	SLK3L3LP	196708	7-15	SPPM6S4	336220	1-26
SLK2L2	196538	7-14	SLK3L3R2	196625	7-14	SPPM8HD	336210	1-26
SLK2L2AB	196529	7-9	SLK3L5	196703	7-14	SPPM8S4	336230	1-26
SLK2L2DW6	196837	7-7	SLK3L5AB	196715	7-9	SPRAM10EG	315105	11-10
SLK2L2GBSF	197814	7-11	SLK3L5DW6	196845	7-7	SPRAM10HD	315100	11-10
SLK2L2LP	196543	7-15	SLK3L5LP	196709	7-15	SPRAM10S6	315120	11-10
SLK2L2R2	196619	7-14	SLK3L5R2	196626	7-14	SPRAM12EG	315115	11-10
SLK2L2SEM8	196559	7-16	SLK3L5WA6	196725	7-17	SPRAM12HD	315110	11-10
SLK2L2SF	196546	7-10	SLK3L7	196704	7-14	SPRAM6EG	315085	11-10
SLK2L2WA6	196734	7-17	SLK3L7AB	196728	7-9	SPRAM6HD	315080	11-10
SLK2L3	196539	7-14	SLK3L7DW6	196846	7-7	SPRAM6S6	315180	11-10
SLK2L34H24	196535	7-13	SLK3L7WA6	196726	7-17	SPRAM8EG	315095	11-10
SLK2L34H58	196536	7-13	SLK6C2	196820	7-6	SPRAM8HD	315090	11-10
SLK2L3AB	196530	7-9	SLK6L10	196801	7-5	SPRAM8S6	315190	11-10
SLK2L3DH	196532	7-12	SLK6L15	196802	7-5	SPRCM10EG	315065	11-11
SLK2L3DW6	196838	7-7	SLK6L20	196803	7-5	SPRCM10HD	315060	11-11
SLK2L3GBSF	197815	7-11	SLK6L25	196804	7-5	SPRCM10S6	315230	11-11
SLK2L3LP	196544	7-15	SLK6L30	196805	7-5	SPRCM12EG	315075	11-11
SLK2L3R2	196620	7-14	SLK6L40	196806	7-5	SPRCM12HD	315070	11-11
SLK2L3SEM6	196560	7-16	SLK6L5	196800	7-5	SPRCM6EG	315045	11-11
SLK2L3SEM8	196561	7-16	SLK6L50	196807	7-5	SPRCM6HD	315040	11-11

F. Index – Part Number / Article Number

Part Number	Article Number	Page	Part Number	Article Number	Page	Part Number	Article Number	Page
SPRCM6S6	315210	11-11	SZB15015EG	402665	5-45	UB4N090M10	599190	9-39
SPRCM8EG	315055	11-11	SZB18010EG	402670	5-45	UB4N090M8	599334	9-39
SPRCM8HD	315050	11-11	SZB18020EG	402675	5-45	UB4N090M8S6	599357	9-39
SPRCM8S6	315220	11-11	T1058	160020	5-15	UB4N114M10	599200	9-39
SR0100EG	597866	9-8	TBHK	597581	5-21	UB4N114M8S6	599348	9-39
SR0125EG	597867	9-8	TBHKM10	597583	5-21	UB4N140M8	599337	9-39
SR0150EG	597868	9-8	TBHKM8	597582	5-21	UB4N140M8S6	599350	9-39
SR0200EG	597869	9-8	TBHS	597575	9-52	UB4N160M8	599338	9-39
SR6	597865	9-8	TCAM10040	593170	5-48	UB4N160M8S6	599351	9-39
SSG022RO	574600	9-21	TCAM12050	400420	5-48	UB4N168M14	599240	9-39
SSG028RO	574610	9-21	TCAM16065	400421	5-48	UB4N168M8S6	599352	9-39
SSG0359RO	574725	9-21	TCAM6025	593145	5-48	UB4N219M10	599341	9-39
SSG035RO	574620	9-21	TCAM6030	593150	5-48	UB4N219M10S6	599354	9-39
SSG043RO	574630	9-21	TCAM8030	593160	5-48	UB4N219M16	599250	9-39
SSG049RO	574640	9-21	TCAM8040	593165	5-48	UB4N273M10S6	599355	9-39
SSG061RO	574650	9-21	TDH	179920	5-19	UB4N273M16	599260	9-39
SSG077RO	574660	9-21	TDHM10	179950	5-20	UB4N323M10	599343	9-39
SSG090RO	574670	9-21	TDHM6	179930	5-20	UB4N323M10S6	599356	9-39
SSG115RO	574680	9-21	TDHM8	179940	5-20	UBH350M8	190490	5-5
SSG141RO	574685	9-21	TDHP2	159441	5-20	UBH500M8	190500	5-5
SSG170RO	574690	9-21	TDHP2PR10	159442	5-20	UBHBTC	190620	5-5
SSG222RO	574700	9-21	THMFM816	592850	5-37	UBHT350	190510	5-5
SSG276RO	574710	9-21	TMN08030EG	590220	11-12	UBHT500	190520	5-5
SSG327RO	574720	9-21	TMN08040EG	590080	11-12	UC202000PG	312200	11-56
SSG410RO	574730	9-21	TMN08040S4	590093	11-12	UPH0050EG	400320	9-36
STCB10M	181580	11-31	TMN08050EG	590221	11-12	UPH0050PL	400313	9-36
STRC012CU	574170	9-30	TMN08060EG	590222	11-12	UPH0075EG	400321	9-36
STRC015CU	574180	9-30	TMN08100EG	590223	11-12	UPH0075PL	400314	9-36
STRC018CU	574190	9-30	TMN10030EG	590218	11-12	USC016EG	712030	9-32
STRC022CU	574200	9-30	TMN10040EG	590090	11-12	USC020EG	712040	9-32
STRC028CU	574210	9-30	TMN10040S4	590094	11-12	USC021EG	712045	9-32
STS	315450	11-7	TMN10050EG	590224	11-12	USC021HD	712405	9-33
SXD014	400063	9-16	TMN10060EG	590225	11-12	USC022EG	712050	9-32
SXD019	400064	9-16	TMN10080EG	590227	11-12	USC022HD	712410	9-33
SXD023	400065	9-16	TMN12040EG	590100	11-12	USC025EG	712060	9-32
SXD028	400066	9-16	TMN12040S4	590095	11-12	USC026EG	712065	9-32
SXD035	400067	9-16	TSGB16	187190	3-4	USC026HD	712422	9-33
SXD043	400068	9-16	TSGB1624	187199	3-4	USC028EG	712070	9-32
SXD049	400069	9-16	TSGB24	187191	3-4	USC031EG	712080	9-32
SXD052	400070	9-16	TSR1220N	366593	11-59	USC033EG	712085	9-32
SXD058	589350	9-16	TSR1220R	366594	11-59	USC033HD	712428	9-33
SXD061	400071	9-16	TSR1220SLS3	366595	7-25	USC036EG	712090	9-32
SXD067	400072	9-16	TSR3050M10RL	390106	6-9	USC036HD	712430	9-33
SXD073	400073	9-16	TSR3050M8RL	390105	6-9	USC040EG	712100	9-32
SXD080	400074	9-16	UB4N017M6	599110	9-39	USC042EG	712105	9-32
SXD091	400075	9-16	UB4N017M8S6	599345	9-39	USC042HD	712445	9-33
SXD106	400076	9-16	UB4N021M6	599120	9-39	USC046EG	712110	9-32
SXD114	400077	9-16	UB4N021M8S6	599346	9-39	USC048EG	712115	9-32
SXE014	400055	9-15	UB4N027M8	599130	9-39	USC048HD	712452	9-33
SXE019	400056	9-15	UB4N027M8S6	597615	9-39	USC053EG	712120	9-32
SXE023	400057	9-15	UB4N034M8	599140	9-39	USC058HD	712460	9-33
SXE028	400058	9-15	UB4N034M8S6	597625	9-39	USC060EG	712035	9-32
SXE035	400059	9-15	UB4N042M8	599150	9-39	USC060HD	712465	9-33
SXE043	400060	9-15	UB4N042M8S6	597635	9-39	USC063EG	712140	9-32
SXE049	400061	9-15	UB4N049M8	599160	9-39	USC073EG	712160	9-32
SXE052	400062	9-15	UB4N049M8S6	597645	9-39	USC076EG	712165	9-32
SXE058	589310	9-15	UB4N060M8	599170	9-39	USC076HD	712475	9-33
SXE061	589320	9-15	UB4N060M8S6	597655	9-39	USC086EG	712180	9-32
SZB12010EG	402655	5-45	UB4N076M8	599180	9-39	USC086HD	712480	9-33
SZB12030EG	402660	5-45	UB4N076M8S6	597665	9-39	USC101EG	712200	9-32

F. Index – Part Number / Article Number

Part Number	Article Number	Page	Part Number	Article Number	Page	Part Number	Article Number	Page
USC113EG	712220	9-32	ZEA105	387550	11-20	ZWA205S6	388761	11-25
USC113HD	712490	9-33	ZEA106	387560	11-18	ZWA206	387660	11-24
USC143EG	712260	9-32	ZEA107	387570	11-19	ZWA207	387670	11-26
USC159EG	712280	9-32	ZEA107S6	387572	11-19	ZWA207L	387675	11-26
USC168EG	712290	9-32	ZEA108	387580	11-20	ZWA209	387690	11-25
USC178EG	712300	9-32	ZEA108S6	388701	11-20	ZWA212	387870	11-25
USC218EG	712340	9-32	ZEA109	387590	11-21	ZWA213	387880	11-26
USC218HD	712520	9-33	ZEA110	387450	11-20	ZWA214	387890	11-24
USC277HD	712530	9-33	ZGA501	388270	11-35	ZWA215	387900	11-24
UTS150	182031	1-29	ZGA502	388360	11-34	ZWA216	387910	11-23
UTS200	182032	1-29	ZGA503	388370	11-32	ZWA217	387930	11-23
UTS300	182033	1-29	ZGA504	388380	11-32	ZWA218A45	387850	11-22
VAFT	190330	5-11	ZGA505	313821	11-35	ZWA219A45	387920	11-22
VDFCM8040	583850	5-35	ZGA506	313822	11-33	ZWA220	387980	11-26
VDFM10050	593560	5-36	ZGA507	313823	11-34	ZWA223	311840	11-27
VDFM10060	593330	5-36	ZGA508	313824	11-33	ZWA225	311842	11-27
VDFM10080	593340	5-36	ZGA509	313825	11-32	ZZ702	313850	11-28
VDFM10100	593350	5-36	ZGA510	313826	11-33	ZZ704HDEG	313870	11-30
VDFM10100S4	400482	5-36	ZGA512	313828	11-34	ZZA700	388390	11-27
VDFM10120	593370	5-36	ZRA180	388906	11-37	ZZA702	387720	11-28
VDFM10150	593570	5-36	ZSA300	387730	11-40	ZZA705	388421	11-28
VDFM10200	593580	5-36	ZSA301	387740	11-39	ZZA706	388422	11-27
VDFM12120	400403	5-36	ZSA301S6	387742	11-39			
VDFM8050	593270	5-36	ZSA302	387960	11-40			
VDFM8050S4	400477	5-36	ZSA303	387970	11-40			
VDFM8060	593280	5-36	ZT605HD	313260	11-29			
VDFM8070	593290	5-36	ZT606HDEG	313270	11-30			
VDFM8080	593300	5-36	ZT607	313280	11-30			
VDFM8080S4	400478	5-36	ZTA601HD	387701	11-29			
VDFM8100	593310	5-36	ZTA601S6	387710	11-29			
VDFM8120	593400	5-36	ZTA602HD	388006	11-29			
VDFM8150	593410	5-36	ZTA603HD	388066	11-29			
VDFM8200	593420	5-36	ZTA605	388080	11-29			
VDFTM10	401122	5-35	ZTA605S6	387190	11-29			
VDFTM8	401121	5-35	ZU400	313120	11-38			
VF14	179850	5-10	ZU405PG	387805	11-36			
VKM10	187330	5-38	ZUA400	387750	11-38			
VKM6	187310	5-38	ZUA401	387760	11-39			
VKM8	187320	5-38	ZUA402	387770	11-38			
VS200000	402268	9-58	ZUA403	387780	11-39			
WBS1	182015	1-30	ZUA404	387790	11-36			
WBS2	182019	1-29	ZUA405	387800	11-36			
WC812	160890	1-21	ZUA406	387810	11-35			
WCTM	181996	1-28	ZUA407	387820	11-35			
ZAA180	388901	11-37	ZUA408	387830	11-36			
ZB11MM35X35	387975	5-29	ZW200	313330	11-21			
ZE100	313000	11-17	ZW201	313340	11-21			
ZE102	313020	11-18	ZW202	313350	11-23			
ZE104	313040	11-19	ZW205	313380	11-25			
ZE107	313070	11-19	ZW207	313400	11-26			
ZE108	313080	11-20	ZW219A45	313640	11-22			
ZEA100	387500	11-17	ZW220	313700	11-26			
ZEA100S6	388710	11-17	ZWA200	387600	11-21			
ZEA101	387510	11-17	ZWA200S6	388670	11-21			
ZEA102	387520	11-18	ZWA201	387610	11-21			
ZEA102S6	387522	11-18	ZWA202	387620	11-23			
ZEA103	387530	11-18	ZWA202S6	387625	11-23			
ZEA103S6	387532	11-18	ZWA203	387630	11-22			
ZEA104	387540	11-19	ZWA204	387640	11-22			
ZEA104S6	387542	11-19	ZWA205	387650	11-25			

Our powerful portfolio of brands:

CADDY ERICO HOFFMAN RAYCHEM SCHROFF TRACER



[nVent.com/CADDY](https://www.nVent.com/CADDY)