

CONNECT AND PROTECT

Solutions for Electrical Power & Earth Connections

- Insulators
- Copper Busbars
- Busbar Supports
- Connecting Clamps
- Earthing Products
- Cabling Sleeves

nvent

ERIFLEX

Table of Contents

Advantages and Markets.....	2
Certificates & nVent ERIFLEX Software.....	4
Product Overview.....	5
Copper Busbars.....	6-7
Connecting Clamps and Accessories.....	8-9
nVent ERIFLEX Connecting, Earthing and Neutral Busbars.....	10
Universal Connecting Bars.....	11
CB Connecting Bars.....	12
Earthing and Neutral Busbar	13-20
Busbar Supports	21-29
Spacers and Accessories.....	30
Insulators	31-32
Sleeves	33-34
Profiles / DIN Rail	35-36
Cross Reference List	37-39

Advantages and Markets

nVENT OFFERS

- A strong worldwide expertise in different markets
- A worldwide team of experts in electrical power connections
- Global solutions manufacturing
- Complete range of high-quality, reliable, certified products
- Innovative and compatible product solutions

ENERGY

- Electrical Power Generators and Distribution
 - Transformers
 - Generators
- Renewable Energies
 - Windmills
 - Solar
 - Hydropower
- Oil, Gas and Petrochemical
- Telecom
- Power Stations



BEFORE



TRANSPORTATION

- Marine
- Aircraft
- Ground Transportation
- Automotive





INDUSTRY & BUILDINGS

- Air Conditioning
- Elevators, Escalators & Automatic Doors



PANELBOARD

- Power
- Control & Command Applications:
 - Power Switchboards
 - Distribution Panel
 - UPS
 - Power Factory Correction



MACHINERY

- Tunneling
- Crunchers
- Printing
- Welding
- Packaging
- Woodworking

AFTER



Certificates & nVent ERIFLEX Software

TESTS & CERTIFICATES

nVent ERIFLEX components are compliant with several agencies and standards to meet all requirements

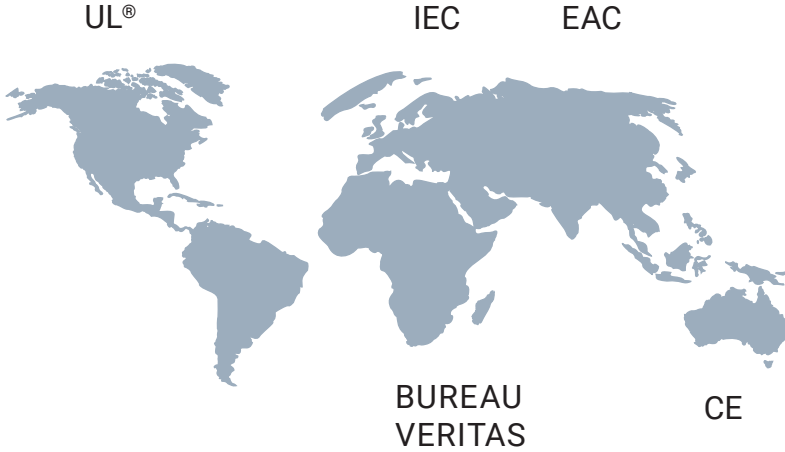

DEDICATED NVENT ERIFLEX SOFTWARE AVAILABLE











nVent has designed an interactive software that allows drawing your technical panel layout with all components and relevant information on them.

The software is developed according to the new IEC 61439-1 standard. Inside, you will discover: updated pricing, products information and project calculator.

Whether you're interested in making a complete low-voltage busbar system, a distribution kit, or if you need to determine a flexible connection with nVent ERIFLEX Flexibar, you can trust nVent ERIFLEX software to help simplify the process.

The software will also provide you with technical and commercial datasheets dedicated to your project.

For more information or to request your personal login information, contact your local nVent representative or visit eriflex-configurator.nVent.com/eriflex

-  International Electrotechnic Commission
IEC 60439.1 Standard
IEC 61439.1 Standard
-  Underwriters Laboratories
UL Recognized, File No. E125470
UL Recognized, File No. E322841
-  UL Listed, File No. E220029
-  European Conformity
-  Bureau VERITAS
Certificate No. 02859 / DO BV for
shipboard use
-  EAC
Certificate compliance for Russia
-  RoHS Compliant
-  Halogen free material as per UL and IEC
-  Flame retardant
-  Low smoke

A COMPLETE SOLUTION FOR:

- Optimal design
- Standard compliance
- Cost effective
- Quality environment



<https://eriflex-configurator.nVent.com/eriflex/>

Product Overview

Product Range	Typical Uses	Typical Market
Copper busbars 	<ul style="list-style-type: none"> • Heavy-duty power connection • Circuit breaker, generator & prefabricated power network conductor • Alternative to large & multiple cables • Earth/ground connection • Power distribution 	<ul style="list-style-type: none"> • Power distribution switchgear • Marine transportation • Machinery manufacturing • Busduct • Power generation
Connecting clamps 	<ul style="list-style-type: none"> • Heavy-duty power connection • Connection between busbar/flexible busbar/cable • Power distribution • "On site" installation/modification 	<ul style="list-style-type: none"> • Power distribution switchgear • Power generation • Telecom • Machinery manufacturing • Busduct
Universal connecting bars 	<ul style="list-style-type: none"> • 450A power distribution bar • Unipolar distribution from busbar to cable • "On site" installation/modification 	<ul style="list-style-type: none"> • Power distribution switchgear • Telecom • Machinery manufacturing • Industry & buildings
Earthing / Grounding products 	<ul style="list-style-type: none"> • Power, earthing/grounding and equipotential connections • Numerous connections • Electrical bonding interconnection 	<ul style="list-style-type: none"> • Switchgear & control equipment • Electrical equipment manufacturers • Power generation (Wind, solar) • Data center
Busbar supports 	<ul style="list-style-type: none"> • Heavy-duty power connection support • Flat, on edge, inclined busbar support • Universal versatile support • Fixed or adjustable busbar support 	<ul style="list-style-type: none"> • Power distribution switchgear • Marine transportation • Machinery manufacturing • Busduct • Power generation
Spacer & accessories 	<ul style="list-style-type: none"> • Insulated or non-insulated spacer • Accessories for easy distribution block assembly 	<ul style="list-style-type: none"> • Power distribution switchgear • Machinery manufacturing
Insulators 	<ul style="list-style-type: none"> • Heavy-duty power connection insulator • Flat, on edge, busbar insulator • Universal versatile insulator 	<ul style="list-style-type: none"> • Power distribution switchgear • Marine transportation • Machinery manufacturing
Sleeves 	<ul style="list-style-type: none"> • Expandable cabling sleeves • Wiring mechanical protection • Wiring temperature protection 	<ul style="list-style-type: none"> • Switchgear & control equipment • Transportation • Machinery manufacturing
DIN Rail profiles 	<ul style="list-style-type: none"> • Symmetric/asymmetric profiles • Perforated or non-perforated profiles • Rapid assembly of all kinds of frameworks 	<ul style="list-style-type: none"> • Switchgear & control equipment • Transportation • Machinery manufacturing

Copper Busbars

THREADED BUSBAR

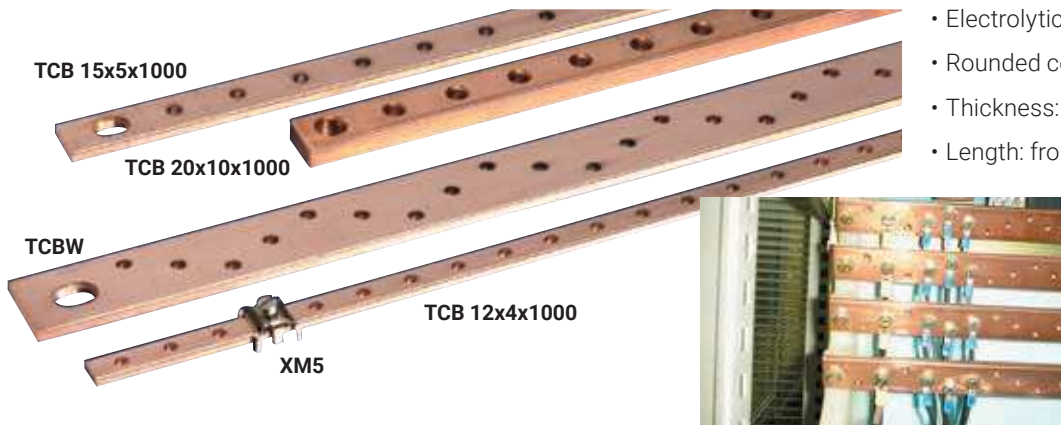

- Electrolytic copper
- Rounded corners
- Thickness: from 2 to 10 mm
- Length: from 1000 to 2000 mm

TCB

..X 5 X 1000 MM

- **Threaded Busbars**
- Thickness 5 mm
- Threaded M5, M6
- Length 1000 mm

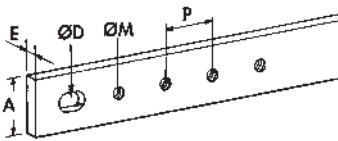

Article No.	Description	A mm	E mm	P mm	ØD mm	ØM	kg
549220	TCB 12 x 5	12	5	18	-	M5	0.50
550210	TCB 15 x 5	15	5	25	8 x 12	M6	0.65
550220	TCB 20 x 5	20	5	25	10 x 14	M6	0.85
550230	TCB 32 x 5	32	5	25	12 x 16	M6	1.35

TCB

..X 5 X 2000 MM

- **Threaded Busbars**
- Thickness 5 mm
- Threaded M6
- Length 2000 mm

Article No.	Description	A mm	E mm	P mm	ØD mm	ØM	kg
549000	TCBS 15 x 5	15	5	17.5	8 x 12	M6	1.19
549010	TCB 20 x 5	20	5	25	10 x 14	M6	1.67
549020	TCB 30 x 5	30	5	25	12 x 16	M6	2.50

TCB

..X 2/4 X 1000 MM

- **Threaded Busbars**
- Thickness 2 - 4 mm
- Threaded M5, M6, M8
- Length 990 mm

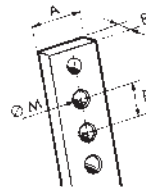

Article No.	Description	A mm	E mm	P mm	ØM	kg
549230	TCB 12 x 2 x 1000	12	2	18	M5	0.300
550200	TCB 12 x 4 x 1000	12	4	18	M5	0.430
549200	TCB 18 x 4 x 1000	18	4	20	M8	0.600
549210	TCB 25 x 4 x 1000	25	4	20	M6	0.800

TCB

12 X 4 X 2000 MM

- **Threaded Busbars 12 x 4**
- Thickness 4 mm
- Threaded M5
- Length 1985 mm

Article No.	Description	A mm	E mm	P mm	ØM	kg
550190	TCB 12 x 4 x 2000	12	4	18	M5	0.850

CONNECTOR XM5

FOR 12 X 4 THREADED BUSBARS

Article No.	Description	kg
550250	Connector XM5	0.010

TCBW

• Threaded Busbars 32 x 5W

- Connections: 40% more
- Thickness 5 mm
- Threaded M6
- Length 2000 mm

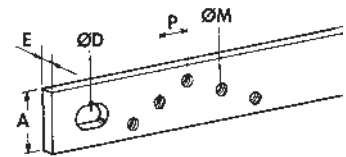

Article No.	Description	A mm	E mm	P mm	ØD mm	ØM	kg
549030	TCBW 32 x 5 x 2000	32	5	17.5	12 x 16	M6	2.65

TCB

..X 10 X 1000/2000 MM

- **Threaded Busbars**
- Thickness 10 mm
- Threaded M8
- Length 1000 and 2000 mm

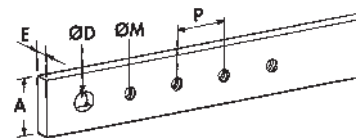

Article No.	Description	A mm	E mm	P mm	ØD mm	ØM	kg
550290	TCB 20 x 10 x 1000	20	10	25	10	M8	1.67
550180	TCB 30 x 10 x 1000	30	10	25	10	M8	2.50

Article No.	Description	A mm	E mm	P mm	ØD mm	ØM	kg
550160	TCB 30 x 10 x 2000	30	10	25	10	M8	5.4

OTHER THREADED BARS ON REQUEST

Copper Busbars

PUNCHED AND PLAIN BUSBARS

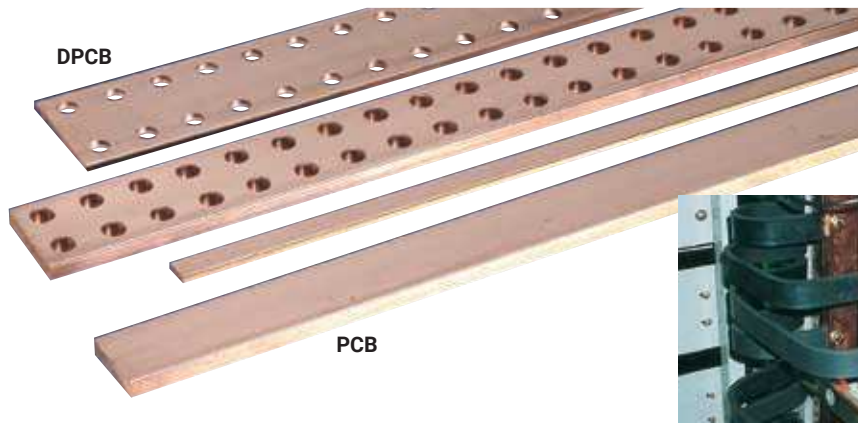

- Design and assembly time saving
- Current: up to 7400 A
- Thickness: from 4 to 10 mm
- Length: from 1000 to 4000 mm

DPCB

PUNCHED BUSBARS

Thickness 5 mm

- Length 1750 mm
- Width 25 to 125 mm

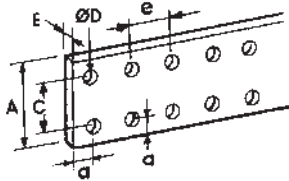

Article No.	Description	A mm	C mm	a mm	e mm	ØD mm	kg
550400	DPCB 25 x 5	25		12.5	25	10.5	2
550410	DPCB 50 x 5	50	25	12.5	25	10.5	2
550420	DPCB 63 x 5	63	38	12.5	25	10.5	2
550430	DPCB 80 x 5	80	55	12.5	25	10.5	2
550440	DPCB 100 x 5	100	75	12.5	25	10.5	2
550450	DPCB 125 x 5	125	100	12.5	25	10.5	2

Thickness 10 mm

- Length 1750 mm
- Width 50 to 120 mm

Article No.	Description	A mm	C mm	a mm	e mm	ØD mm	kg
550350	DPCB 50 x 10	50	25	12.5	25	10.5	2
550360	DPCB 60 x 10	60	35	12.5	25	10.5	2
550370	DPCB 80 x 10	80	55	12.5	25	10.5	2
550380	DPCB 100 x 10	100	75	12.5	25	10.5	2
550390	DPCB 120 x 10	120	95	12.5	25	10.5	2

PCB

PLAIN BUSBARS

Thickness 4 or 5 mm

- Length 1000 and 2000 mm

Article No.	Description	L mm	A mm	E mm	kg
550780	PCB 12 X 4 X 1000	1000	12	4	10
550790	PCB 12 X 4 X 2000	2000	12	4	10
550770	PCB 12 X 5 X 2000	2000	12	5	10

Thickness 5 mm

- Length 2000 - 4000 mm
- Width 20 to 125 mm

Article No.	Description	L mm	A mm	E mm	kg
549600	PCB 2 m 25 x 5	2000	25	5	2
549610	PCB 2 m 50 x 5	2000	50	5	2
549620	PCB 2 m 63 x 5	2000	63	5	2
549630	PCB 2 m 80 x 5	2000	80	5	2
549640	PCB 2 m 100 x 5	2000	100	5	2
550600	PCB 4 m 20 x 5	4000	20	5	10
550610	PCB 4 m 25 x 5	4000	25	5	10
550620	PCB 4 m 30 x 5	4000	30	5	10
550630	PCB 4 m 40 x 5	4000	40	5	10
550640	PCB 4 m 50 x 5	4000	50	5	10
550650	PCB 4 m 60 x 5	4000	60	5	10
550660	PCB 4 m 80 x 5	4000	80	5	10
550670	PCB 4 m 100 x 5	4000	100	5	10



Thickness 10 mm

- Length 2000–4000 mm
- Width 30 to 200 mm

Article No.	Description	L mm	A mm	E mm	kg
549700	PCB 2 m 30 x 10	2000	30	10	2
549710	PCB 2 m 40 x 10	2000	40	10	2
549720	PCB 2 m 50 x 10	2000	50	10	2
549730	PCB 2 m 60 x 10	2000	60	10	2
549740	PCB 2 m 80 x 10	2000	80	10	2
549750	PCB 2 m 100 x 10	2000	100	10	2
549760	PCB 2 m 120 x 10	2000	120	10	2
550970	PCB 4 m 30 x 10	4000	30	10	5
550980	PCB 4 m 40 x 10	4000	40	10	5
550990	PCB 4 m 50 x 10	4000	50	10	5
550910	PCB 4 m 60 x 10	4000	60	10	5
550920	PCB 4 m 80 x 10	4000	80	10	5
550930	PCB 4 m 100 x 10	4000	100	10	2
550940	PCB 4 m 120 x 10	4000	120	10	2
550950	PCB 4 m 160 x 10	4000	160	10	2

Connecting Clamps and Accessories

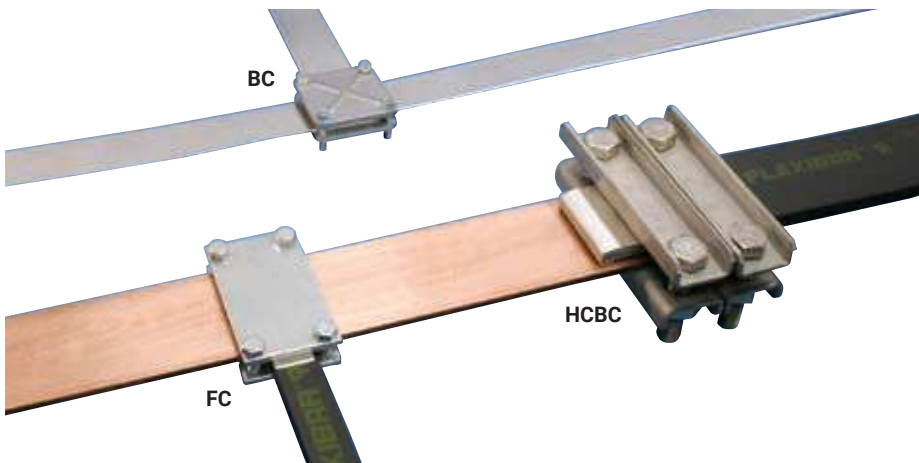

CONNECTING CLAMPS

- Allows excellent electrical contact
- Very compact: space saving
- Quick installation
- Ideal for "on site" modifications

FC

FLEXIBAR CLAMP

- Clamping capacity: 20 mm
- 2 zinc plated steel plates complete with M8 screws 8.8 class

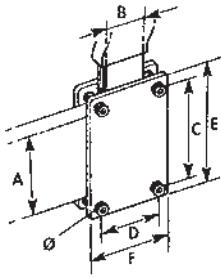

Article No.	Description	A mm	B mm	C mm	D mm	E mm	F mm	Torque N.m	kg
553020	FC 50 x 24	50	20-25	60	36	75	52	10	0.319
553030	FC 50 x 32	50	32	60	44	75	60	10	0.362
553040	FC 50 x 40	50	40	60	52	75	68	10	0.412
553050	FC 80 x 24	80	20-25	90	36	105	52	10	0.432
553060	FC 80 x 32	80	32	90	44	105	60	10	0.492
553070	FC 80 x 50	80	50	90	62	105	68	10	0.412
568700	FC 100 x 32	100	32	110	44	125	52	10	0.432
568730	FC 120 x 32	120	32	130	44	145	60	10	0.492

BC

RIBBED-STEEL BUSBAR CLAMP

- Clamping capacity: 20 mm
- 2 ribbed zinc-plated hardened-steel plates complete with screws
- Maximum clamping capacity is 50 mm using longer screws 8.8 class
- UL® 67 recognized

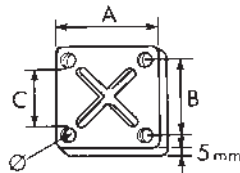

Article No.	Description	A mm	B mm	C mm	Ø mm	Torque N.m	kg
553200	BC 30	56	42	30	M6	7	0.31
553210	BC 40	66	52	40	M6	7	0.37
553220	BC 50	83	64	50	M8	20	0.59
553230	BC 63	93	74	63	M8	20	0.74
553250	BC 80	118	96	80	M10	40	1.118
553260	BC 100	144	118	100	M10	40	1.72



HCBC

HIGH CURRENT BUSBAR CLAMP

- Clamping capacity: 40 mm
- This modular busbar clamp is designed with non-magnetic materials for high current connections between Flexibar and rigid busbars such as transformer terminals
- Its mechanical design assures rigidity and even contact pressure
- Use 2 clamps to guarantee the contact pressure

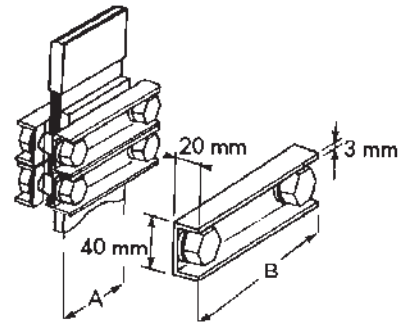

Article No.	Description	A mm	B mm	Torque N.m	kg
553100	HSBC 80	80	140	100	0.84
553110	HSBC 100	100	160	100	0.92
553120	HSBC 120	120	180	100	1.00

Connecting Clamps and Accessories

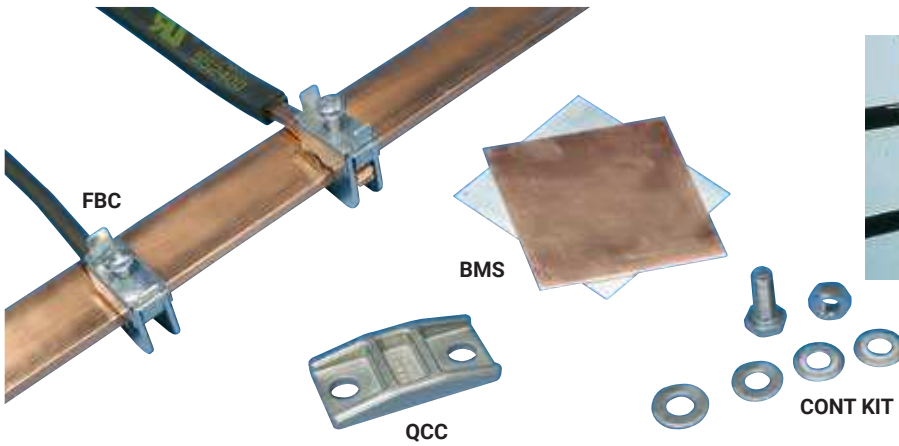

FBC

CONNECTORS FOR CONNECTING WITHOUT DRILLING

- Very compact connector for connecting without drilling to a 5 or 10 mm thick busbar:
- Cables from 1 mm² up to 185 mm² or Flexibar width 6 to 20 mm
- Self-support of connector during mounting procedure
- IEC 60999

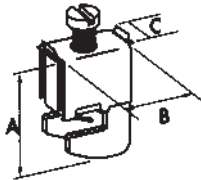

FLEXIBAR TYPE

CONNECTORS FOR BUSBARS THICKNESS 5 MM

Article No.	Description	A mm	B mm	C mm	Flexibar type	Torque N.m	Cable Size mm ²	kg
553405	FBC 5 x 4	23	29	11		2	1-4	0.016
553400	FBC 5 x 6	28	31	14	6 mm	3	2.5-16	0.028
553410	FBC 5 x 9	36	40	19	9 mm	6-8	16-50	0.068
553510	FBC 5 x 15.5	44	40	25	15.5 mm	10-12	35-70	0.110
553520	FBC 5 x 20	48	40	31	20 mm	12-15	70-185	0.132

CONNECTORS FOR BUSBARS THICKNESS 10 MM

Article No.	Description	A mm	B mm	C mm	Flexibar type	Torque N.m	Cable Size mm ²	kg
553505	FBC 10 x 4	28	29	12		2	1-4	0.018
553430	FBC 10 x 6	33	31	14	6 mm	3	2.5-16	0.030
553440	FBC 10 x 9	42	40	19	9 mm	6-8	16-50	0.070
553530	FBC 10 x 15.5	49	40	25	15.5 mm	10-12	35-70	0.112
553540	FBC 10 x 20	54	40	31	20 mm	12-15	70-185	0.138

BMS

BIMETAL PLATE

- For high performance contact between an aluminum busbar and a copper busbar.
- 70% aluminum-30% copper

Article No.	Description	Size	kg
553080	BMS 100	100 x 100 x 1	0.058
553090	BMS 500	500 x 500 x 1	1.45

QCC

CLAMPS ERIFLEX FLEXIBAR

- For Flexibar thickness ≤ 5 mm = 1 clamp
- For Flexibar thickness > 5 mm = 2 clamps

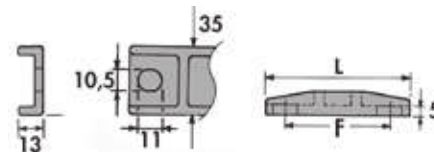

Article No.	Description	Flexibar width		L mm	F mm	kg
		min. mm	max. mm			
561210	QCC 15.5/32	15.5	32	70	50	0.112
561220	QCC 40/63	40	63	95	75	0.158

CONT KIT

METAL NUTS AND BOLTS CONTACT KITS

- For good electrical contact:
- 100 nuts - 100 bolts
- 200 flat washers
- 200 contact washers (class 8/8 ZN8C protection)

Article No.	Description	Dimensions	Torque N.m	kg
558310	CONT KIT M 6 x 16	HM 6 x 16	13	0.012
558340	CONT KIT M 8 x 30	HM 8 x 30	30	0.028
558370	CONT KIT M 10 x 30	HM 10 x 30	60	0.052
558410	CONT KIT M 10 x 50	HM 10 x 50	60	0.062
558440	CONT KIT M 12 x 30	HM 12 x 30	110	0.081
558460	CONT KIT M 12 x 40	HM 12 x 40	110	0.090
558480	CONT KIT M 12 x 50	HM 12 x 50	110	0.097
567880	CONT KIT M 12 x 60	HM 12 x 60	110	0.116
558490	CONT KIT M 12 x 80	HM 12 x 80	110	0.150

CLAMPING TORQUE CALCULATION

With a class 8.8 zinc plated bolt. Using contact washers tightened with a torque wrench. Without lubrication.

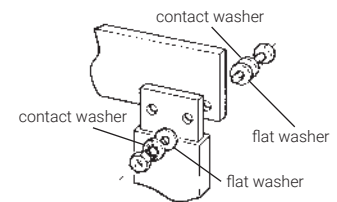

Ø	M6	M8	M10	M12	M14	M16
F (daN)	800	1450	2300	3700	4400	6000
Clamping torque Nm	13	30	60	110	174	274

nVent ERIFLEX Connecting, Earthing and Neutral Busbars



nVent ERIFLEX Connecting, Earthing and Neutral Busbars range are used to connect several earthing conductors within a panel and can be used in a variety of different applications including switchgear and control equipment, electrical equipment, wind and solar power generation and data centers.

Some bars can be used as power distribution bars or be used to collect DC current from Solar Panels.

nVent ERIFLEX Connecting, Earthing and Neutral Busbars range offers solutions for a wide variety of applications:

- Bars made of different materials such as Tinned aluminum, Brass, Nickel plated Brass and Copper
- Wide range of different fixed lengths, or ability to be cut to length if desired
- Many connection possibilities ranging from 2 to 260 conductors on the same bar

- A variety of conductor cross sections ranging from 1.5mm² (#16) to 50mm² (#1/0)
- A large range of mounting support which can be for insulation or conductors, for DIN rail or mounting plates and for one or two bars
- Meets worldwide standards with IEC and/or UL certification

Universal Connecting Bars





UNIVERSAL CONNECTING BAR





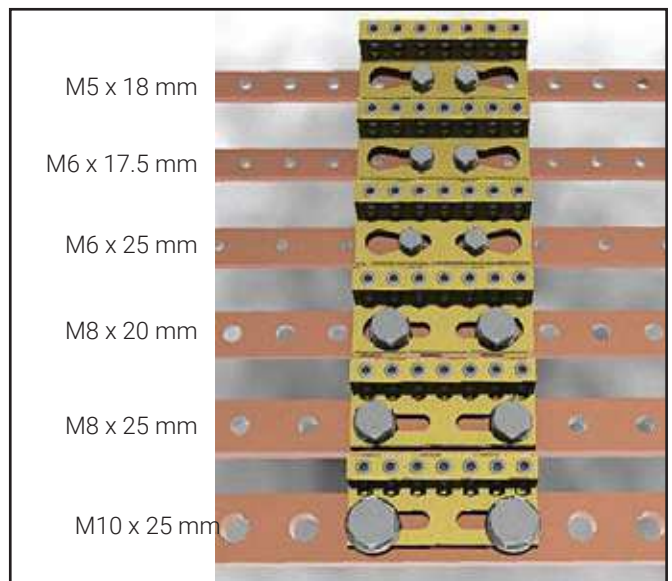
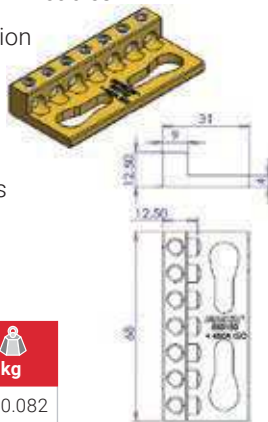





CB 7X16²-450A

- Offers a current rating up to 450A
- Easy to wire with a hexagonal key
- Allows visual inspection of wire and confirmation of connection
- For use with punched or threaded copper busbar
- Can connect up to seven 1.5 to 16 mm² cables
- High fill ratio allows output connection with or without terminal
- Features high-conductivity brass material
- UL Listed for grounding applications



Article No.	Description	Diameter mm		 kg
553150	CB 7x16 ²	7.5	10	0.082

	Metric mm ²	Imperial AWG			r' (N.m)	Torque inch/lbs		
	1.5 ➤ 16	8 ➤ 1/0	x7	3.5	31			

 with terminal
 without terminal, rigid cable

The connecting bar is a 450 A power distribution bar that is designed to be connected to threaded or perforated copper or tinned aluminum busbar. Part of the nVent ERIFLEX line of low-voltage power distribution products from nVent, this compact system is only 68 mm long and allows for the connection of up to seven 1.5 to 16 mm² output cables.

Featuring high-conductivity brass material, the connecting bar is quick and easy to install, requiring only two M5 to M10 screws with a pitch from 18 mm to 25 mm. The hexagonal key helps simplify wiring, and the convenient design allows visual inspection of the wire and confirmation of the connection. The high fill ratio allows an output connection with or without a terminal.

CB Connecting Bars



FEATURES

- Ideal for solar applications
- Tinned aluminum bar allows for copper or aluminum conductor connections
- Design allows for visual inspection of conductor and confirmation of connection
- Can be fixed on standoff insulators or punched or threaded copper busbar
- High fill ratio allows output connection with or without terminal

Material: Aluminum
Finish: Tinned



Description	CB14X10AL	CB20X10AL	CB32X10AL
Article Number	553152	553153	553151
Max Current Rating, IEC	450 A	640 A	1 020 A
Number of Connections	14	20	32
Conductor Size, IEC	(14) 1.5–6 mm ² Stranded	(20) 1.5–6 mm ² Stranded	(32) 1.5–6 mm ² Stranded
Ferrule Conductor Size, IEC	(14) 2.5–6 mm ²	(20) 2.5–6 mm ²	(32) 2.5–6 mm ²
Conductor Size, UL	(14) #14 - #6 Solid (14) #16 - #6 Stranded	(20) #14 - #6 Solid (20) #16 - #6 Stranded	(32) #14 - #6 Solid (32) #16 - #6 Stranded
Depth (D)	22 mm		
Height (H)	72 mm		
Width (W)	61.5 mm	88.0 mm	141.5 mm
Thickness (T)	2.5 mm		
Hole Size 1 (HS1)	6.6 mm		
Hole Size 2 (HS2)	–		13.5 mm
A	9.5 mm		
B	31.8 mm		
C	36.0 mm	62.8 mm	122.5 mm
E	–		44.5 mm
Torque (TQ)	2 N·m		
Unit Weight	0.07 kg	0.10 kg	0.16 kg
Complies With	IEC® 60947-1 IEC® 60998-2-1		
Packing Unit	10pc		

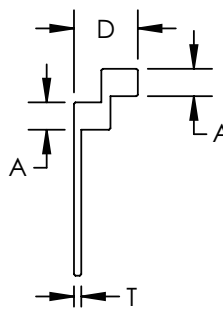
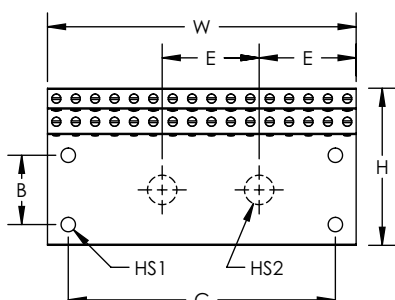

Earthing Products

EB 60
EB 20
EB 44

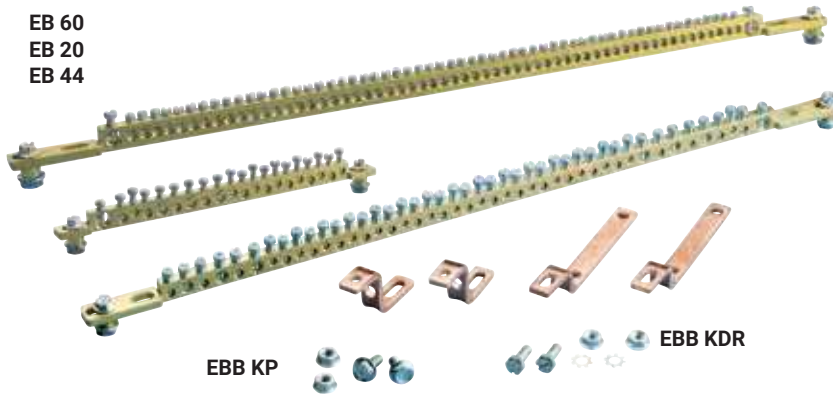

- Universal fixing
- Numerous connections
- Easy connections due to chamfer
- Rigid bar
- High conductivity brass quality
- Copper Brackets kit for easy fixing
- UL Listed for grounding applications



Fixing on Copper Bar

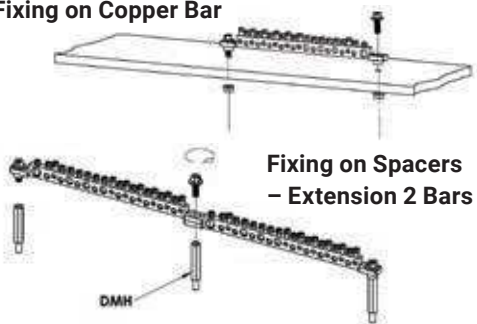

Direct Fixing

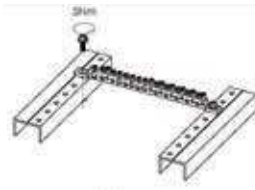

Fixing on Spacers - Extension 2 Bars

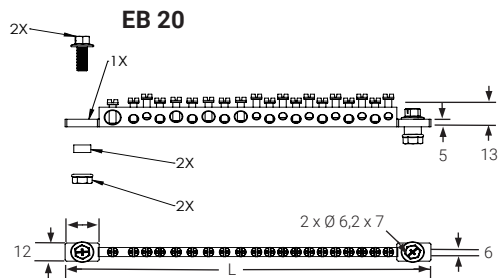

Ø	<12 mm			EB20	EB44	EB60
9.1 mm	16 - 35 mm ²	10 - 35 mm ²	2 Nm	x 1	x 1	x 1
7.0 mm	4 - 16 mm ²	2.5 - 16 mm ²	2 Nm	x 3	x 6	x 1
5.3 mm	2.5 - 6 mm ²	1.5 - 6 mm ²	1.5 Nm	x 9	x 21	
4.5 mm	1.5 - 4 mm ²	0.75 - 4 mm ²	1.5 Nm	x 7	x 17	x 58

Article No.	Description	L		kg
568660	EARTH BAR EB 44	462	1	0.300
568661	EARTH BAR EB 60	462	1	0.311
568662	EARTH BAR EB 20	215	1	0.193

EB 44

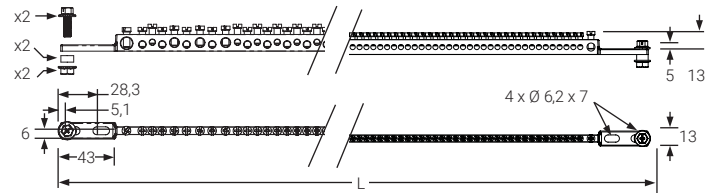

EB 60

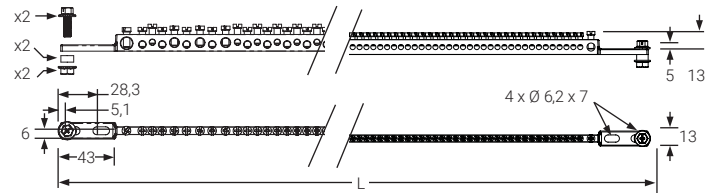

Fixing on DIN Rail Using EBB KDR Kit 568665

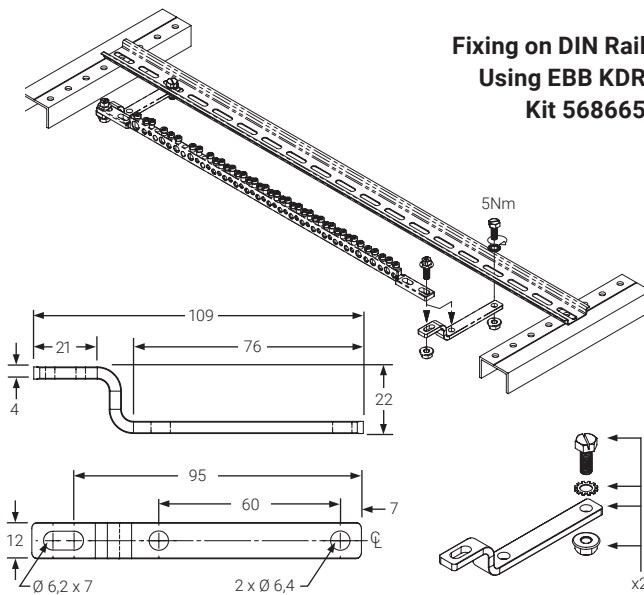

Fixing 2 Bars Using EBB KP Kit 568666

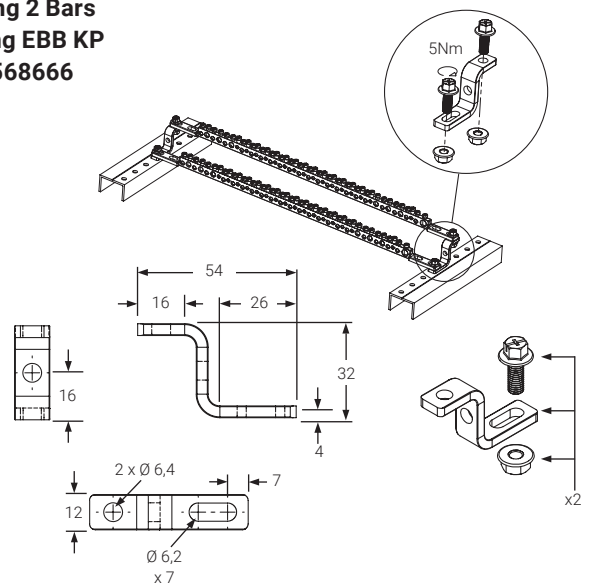

Article No.	Description		kg
568665	EBB KDR KIT DIN RAIL	1	0.064

Article No.	Description		kg
568666	EBB KP KIT PLATE	1	0.102

Earthing Products

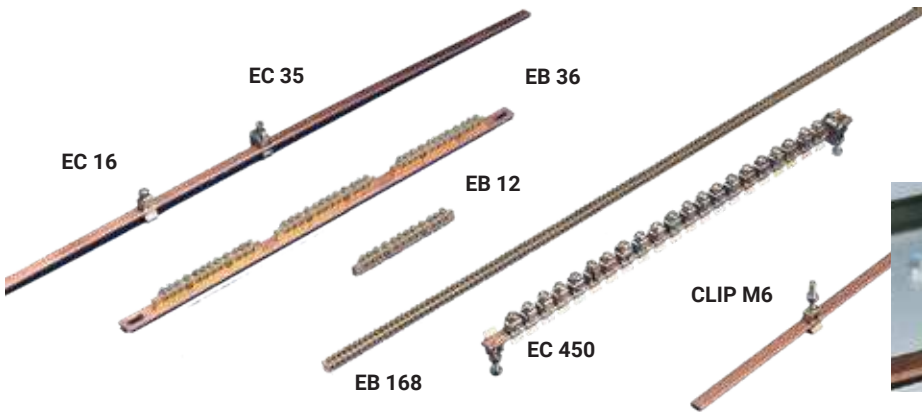

- Quick and easy connections
- Large and versatile range
- Connections: from 2,5 to 35 mm²



EC

EARTHING CONNECTORS

- FOR PLAIN BARS 12 x 4 and 12 x 5 with rounded corners
- Conductor is clamped through a pressure plate
- Connectors will slide and self-support before fixing of conductor
- Single screw locks clamp and makes connection
- Connections can be added after bar has been mounted

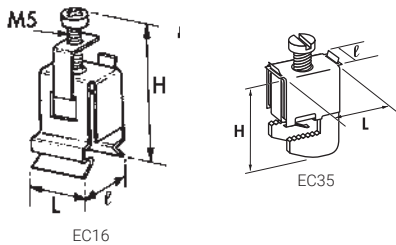

16 mm² flexible cable
35 mm² rigid cable

Article No.	Description	L mm	I mm	H mm	kg
553460	EC 16-4	17	14	38	0.010
553480	EC 16-5	17	14	38	0.010
553470	EC 35	31	11.5	27	0.025

EB

EARTHING AND NEUTRAL BUSBAR

- EB 12 : earthing brass busbar 13 x 6 for 10 connections 16 mm² and 2 connections 35 mm²
- EB 36 : earthing copper busbar 15 x 4 equipped with 3 EB12
- EB 168 : earthing brass busbar 8 x 8 for 168 connections 10 mm²

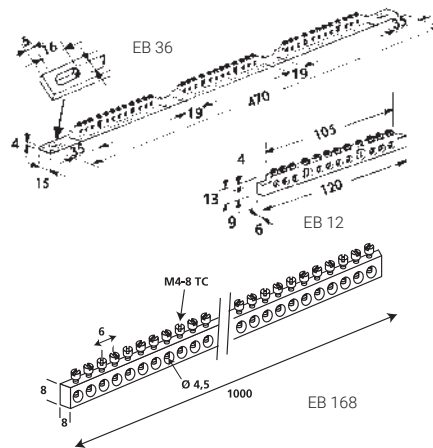

Article No.	Description	kg
568610	EB 12	0.068
568611	EB 12	0.068
568620	EB 36	0.456
568630	EB 168	0.454



KIT EC 450

EARTHING KIT

- Plain bar 12 x 4 x 475 mm long.
- 1 connector 35 mm²
- 20 connectors 16 mm² + 2 mounting clips

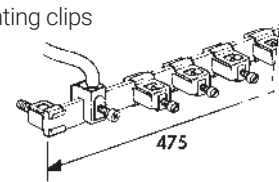

Article No.	Description	kg
562100	KIT EC 450	0.362

CLIP M6

MOUNTING CLIP

- FOR PLAIN BARS 12 x 4 and 12 x 5

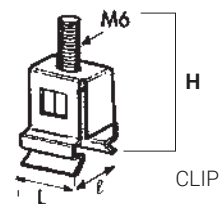

Article No.	Description	L mm	I mm	H mm	kg
553450	CLIP M6-4	17	14	38	0.010
553490	CLIP M6-5	17	14	38	0.010

MBJ



Article No.	Description	Intensity A	Thick. mm	Section mm ²	L mm	Ø mm	J mm	T mm	kg
563410	MBJ 6-200-6	40	1.1	6	200	6.5	13	23	0.0167
556640	MBJ 16-200-8	120	1.5	16	200	8.5	15	25	0.033
556740	MBJ 30-200-10	180	2	30	200	10.5	23	33	0.062

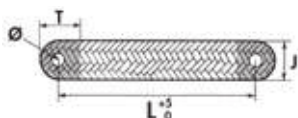
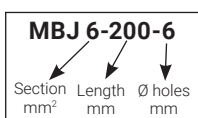

BJ

Article No.	Description	Section mm ²	L mm	Ø D mm	Intensity A	kg
556910	BJ 6-200 S	6	200	6.5	45	0.015



EB-142 and EB-166 Earthing and Neutral Busbar & Accessories



FEATURES

- Use to connect several earthing conductors
- Chamfered holes allow for easy connections
- Nickel plating is corrosion resistant
- Rigid bar
- Cut to length as needed
- Quick and easy installation
- RoHS compliant

Material: Brass
Finish: Nickel Plated



Description	EB142	EB166
Article Number	568668	568667
Number of Connections	142	166
Conductor Size, IEC	1.5 - 16 mm ² Stranded	1.5 - 10 mm ² Stranded
Max Current Rating	63 A	40 A
Cross Section	80 mm ²	64 mm ²
Depth (D)	8 mm	
Height (H)	10 mm	8 mm
Width (W)	1 000 mm	
Hole Size (HS)	5.5 mm	4.5 mm
Thread Size (TS)	M5	M4
A	7 mm	6 mm
Torque (TQ)	2.0 N-m	1.2 N-m
Unit Weight	0.583 kg	0.468 kg
Complies With	IEC® 60998-2-1	
Packing Unit	10pc	

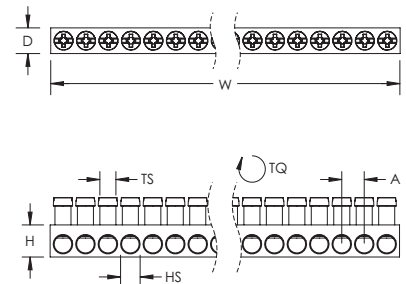

EB-142/166 SINGLE NEUTRAL BUSBAR SUPPORT

- Provides support for one EB-142 or EB-166 Earthing and Neutral Busbar
- Quick and easy installation
- Halogen free
- RoHS compliant



Description	Article Number	Packing Unit
EB142-166SUP1	568669	10pc

EB-142/166 DUAL NEUTRAL BUSBAR SUPPORT

- Provides support for two EB-142 or EB-166 Earthing & Neutral Busbars
- Quick and easy installation
- Halogen free
- RoHS compliant



Description	Article Number	Packing Unit
EB142-166SUP2	568670	10pc

EB-142 MAIN TERMINAL CLAMP

- For conductor up to 35mm²



Description	Article Number	Packing Unit
EB142CON35	568672	10pc

EB-166 MAIN TERMINAL CLAMP

- For conductor up to 25mm²

Description	Article Number	Packing Unit
EB166CON25	568671	10pc

EB-130 and EB-2X130 Earthing and Neutral Busbar & Accessories



FEATURES

- Use to connect several earthing conductors
- Chamfered holes allow for easy connections
- Nickel plating is corrosion resistant
- Rigid bar
- Cut to length as needed
- Quick and easy installation
- RoHS compliant

Material: Brass
Finish: Nickel Plated



Description	EB130	EB2X130
Article Number	568673	568674
Number of Connections	130	260
Conductor Size, IEC	1.5 - 25 mm ² Stranded	1.5 - 25 mm ² Stranded
Max Current Rating	125 A	200 A
Cross Section	150 mm ²	225 mm ²
Depth (D)	15 mm	15 mm
Height (H)	10 mm	15 mm
Width (W)	1 000 mm	1 000 mm
Hole Size (HS)	6.5 mm	6.5 mm
Thread Size (TS)	M5	M5
A	7 mm	7 mm
Torque (TQ)	2 N-m	2 N-m
Unit Weight	1.035 kg	1.589 kg
Complies With	IEC® 60998-2-1	IEC® 60998-2-1
Packing Unit	5pc	1pc

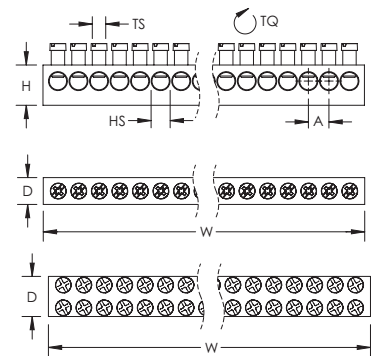

EB-130 DUAL NEUTRAL BUSBAR SUPPORT

- Provides support for two EB-130 or EB-2X130 Earthing and Neutral Busbars
- Quick and easy installation
- Halogen free
- RoHS compliant



Description	Article Number	Packing Unit
EB130SUP2	568675	10pc

EB-130 MAIN TERMINAL CLAMP

- For use with EB-130 or EB-2X130 Earthing and Neutral Busbars
- Quick and easy installation
- RoHS compliant
- For conductor up to 35mm²
- For conductor up to 70mm²



Description	Article Number	Packing Unit
EB130CON35	568676	10pc
EB130CON70	568677	10pc

Earthing and Neutral Busbars with Green/Yellow DIN Rail Clip



FEATURES

- Use to connect several earthing conductors
- Easy for the installer to add connections
- Chamfered holes allow for easy connections
- Rigid bar
- Quick and easy installation on DIN rail
- Halogen free

Material: Brass; Polyethylene



Description	EB7GYSUP	EB12GYSUP	EB15GYSUP
Article Number	568678	568679	568680
Number of Connections	7	12	15
Conductor Size, IEC	(1) 6 - 25 mm ² Stranded (6) 1.5 - 16 mm ² Stranded	(1) 6 - 25 mm ² Stranded (11) 1.5 - 16 mm ² Stranded	(1) 6 - 25 mm ² Stranded (14) 1.5 - 16 mm ² Stranded
Max Current Rating	40 A		
Cross Section	63 mm ²		
Depth (D)	7 mm		
Height (H)	9 mm		
Width (W)	57 mm	92 mm	113 mm
Hole Size 1 (HS1)	6.5 mm		
Hole Size 2 (HS2)	5.5 mm		
Thread Size (TS)	M5		
Torque (TQ)	2 N-m		
Unit Weight	0.030 kg	0.047 kg	0.057 kg
Complies With	IEC® 60998-2-1		
Packing Unit	10pc		

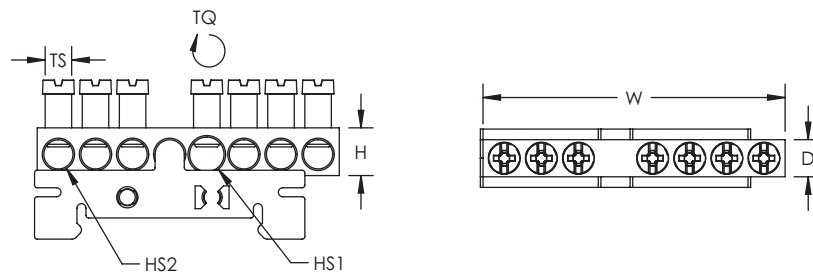

EBC-133 Earthing and Neutral Busbars



FEATURES

- Easy for the installer to add connections
- Clamps are fully assembled
- Clamps follow the screw vertically, making it quick and easy to mount the conductor
- Cut to length as needed
- Main terminal clamp available for thicker conductors
- Can be connected to IBSB25 Insulated Braided Conductor, MBJ Grounding and Bonding Braid, and nVent ERIFLEX Flexibar up to 9 mm (0.354")
- Quick and easy installation
- RoHS compliant

Material: Copper; Steel
Finish: Electrogalvanized



Description	EBC133-10X3X2000	EBC133-15X5X2000
Article Number	568612	568613
Number of Connections	133	
Conductor Size, IEC	(133) 0.5 - 16 mm ² Solid (133) 0.5 - 10 mm ² Stranded	
Conductor Width	9 mm Max	
Max Current Rating	108 A	218 A
Cross Section	30 mm ²	75 mm ²
Depth (D)	10 mm	15 mm
Width (W)	2 000 mm	
Thickness (T)	3 mm	5 mm
A	15 mm	
B	4.8 mm	6.8 mm
Thread Size (TS)	M5	
Torque (TQ)	2.5 N-m	4.5 N-m
Unit Weight	1.0 kg	1.8 kg
Packing Unit	1pc	

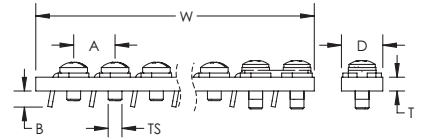

EBC-133 MAIN TERMINAL CLAMP KIT

- Kit includes 10 clamps and 20 screws
- Used to connect thicker conductors including IBSB25 Insulated Braided Conductor, MBJ Grounding and Bonding Braid, and nVent ERIFLEX Flexibar up to 9 mm (0.354")
- For conductors from 16 to 35mm²
- Quick and easy installation
- RoHS compliant

Description	Article Number	Packing Unit
KIT-EBC133-15	568614	10pc

Tinned Aluminum Earthing and Neutral Busbars



FEATURES

- Tinned aluminum bar allows for copper or aluminum conductor connections
- Use to connect several earthing conductors
- Chamfered holes allow for easy connections
- Tin plating is corrosion resistant
- Rigid bar
- Can be fixed using IRS Angle Support Bracket, DMH Metallic Spacer or DH Distance Holder and Spacer
- Quick and easy installation
- RoHS compliant

Material: Aluminum
 Finish: Tinned
 Certification Details: UL® 467



Description	EB2AL	EB4AL	EB6AL	EB10AL	EB12AL	EB20AL
Article Number	568710	568711	568712	568713	568714	568715
Number of Connections	2	4	6	10	12	20
Number of Holes	3	6	8	12	14	22
Conductor Size, IEC	2.5 - 16 mm ² Stranded					
Conductor Size, UL	#14 - #4 Stranded					
Max Current Rating	85 A					
Height (H)	11.2 mm					
Width (W)	24.1 mm	47.8 mm	65.0 mm	96.8 mm	112.5 mm	176.0 mm
Depth (D)	7.9 mm					
Unit Weight	0.003 kg	0.006 kg	0.017 kg	0.026 kg	0.030 kg	0.046 kg
Packing Unit	20 pc					

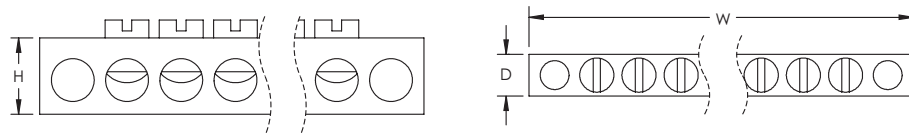

Tinned Aluminum Earthing and Neutral Double Busbars



FEATURES

- Tinned aluminum bar allows for copper or aluminum conductor connections
- Use to connect several earthing conductors
- Chamfered holes allow for easy connections
- Tin plating is corrosion resistant
- Rigid bar
- Can be fixed using IRS Angle Support Bracket, DMH Metallic Spacer or DH Distance Holder and Spacer
- Quick and easy installation
- RoHS compliant

Material: Aluminum
Finish: Tinned



Description	EBD8AL	EBD10AL	EBD14AL	EBD20AL
Article Number	568716	568717	568718	568719
Number of Connections	8	10	14	20
Conductor Size, IEC	(1) 16 - 35 mm ² Stranded (4) 6 - 10 mm ² Stranded (3) 1.5 - 6 mm ² Stranded	(1) 16 - 35 mm ² Stranded (5) 6 - 10 mm ² Stranded (4) 1.5 - 6 mm ² Stranded	(1) 16 - 35 mm ² Stranded (7) 6 - 10 mm ² Stranded (6) 1.5 - 6 mm ² Stranded	(1) 16 - 35 mm ² Stranded (1) 16 - 50 mm ² Stranded (9) 1.5 - 6 mm ² Stranded (9) 6 - 10 mm ² Stranded
Conductor Size, UL	(1) #4 - #2 Stranded (3) #16 - #10 Stranded (4) #8 - #6 Stranded	(1) #4 - #2 Stranded (4) #16 - #10 Stranded (5) #8 - #6 Stranded	(1) #4 - #2 Stranded (6) #16 - #10 Stranded (7) #8 - #6 Stranded	(1) #1 - #1/0 Stranded (1) #4 - #2 Stranded (9) #16 - #10 Stranded (9) #8 - #6 Stranded
Max Current Rating	115 A			
Height (H)	12.7 mm			
Width (W)	63.5 mm	76.2 mm	89.6 mm	123.4 mm
Depth (D)	12.7 mm			
Unit Weight	0.034 kg	0.040 kg	0.048 kg	0.067 kg
Certification Details	UL [®] 486A UL [®] 486B			
Packing Unit	10pc			

Description	EBD26AL	EBD34AL	EBD44AL
Article Number	568720	568721	568722
Number of Connections	26	34	44
Conductor Size, IEC	(1) 16 - 35 mm ² Stranded (1) 16 - 50 mm ² Stranded (12) 1.5 - 6 mm ² Stranded (12) 6 - 10 mm ² Stranded	(1) 16 - 35 mm ² Stranded (1) 16 - 50 mm ² Stranded (16) 1.5 - 6 mm ² Stranded (16) 6 - 10 mm ² Stranded	(1) 16 - 35 mm ² Stranded (1) 16 - 50 mm ² Stranded (21) 1.5 - 6 mm ² Stranded (21) 6 - 10 mm ² Stranded
Conductor Size, UL	(1) #1 - #1/0 Stranded (1) #4 - #2 Stranded (12) #8 - #6 Stranded (12) #16 - #10 Stranded	(1) #1 - #1/0 Stranded (1) #4 - #2 Stranded (16) #8 - #6 Stranded (16) #16 - #10 Stranded	(1) #1 - #1/0 Stranded (1) #4 - #2 Stranded (21) #16 - #10 Stranded (21) #8 - #6 Stranded
Max Current Rating	150 A		
Height (H)	12.7 mm		
Width (W)	149.3 mm	187.7 mm	229.6 mm
Depth (D)	12.7 mm		
Unit Weight	0.082 kg	0.101 kg	0.123 kg
Certification Details	UL [®] 486A UL [®] 486B		
Packing Unit	10pc		

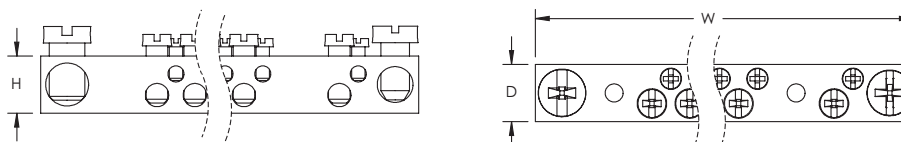

Busbar Supports

FLAT BUSBAR SUPPORTS

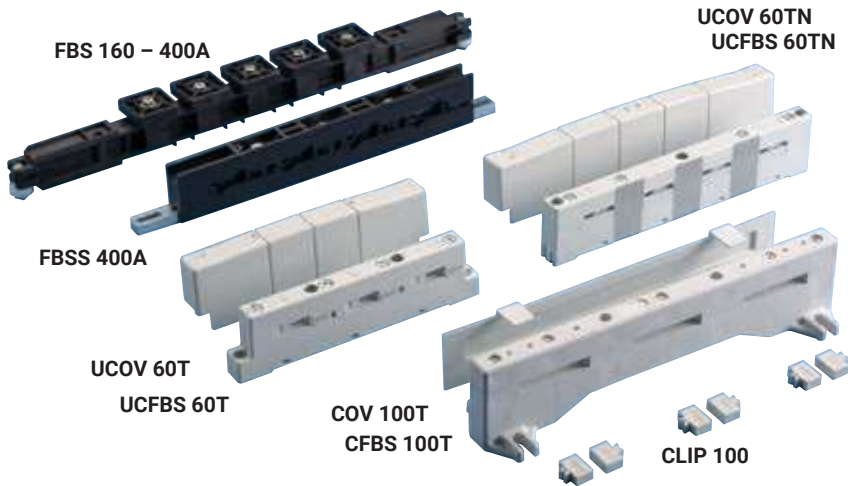

- Universal versatile support
- Minimum space requirement
- Working temperature: -40°C up to 130°C
- Self extinguishing UL® 94 V0

FBS

160 – 400A

- For threaded bars 15-20-32 x 5 mm, 3 phase & neutral circuit
- Plastic positioning pin for bar location
- A screen can be fixed using spacers
- An earth can be mounted on either right or left side
- Halogen free

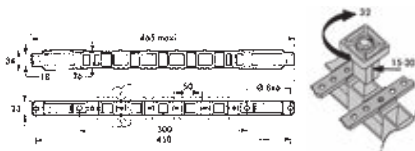

Article No.	Description	Bar width mm	Bar thickness mm		
551350	FBS 400A	15-20-32	5	1	0.30

FBSS

400A

- For bars 32 x 5 without drilling
- Easy connection (inclined bars)
- Adjustable arms for an easy mounting and M6 screw included in the packaging
- Provision for fixing protective screen with self-tapping screws
- Halogen free

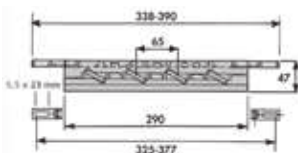

Article No.	Description		
551190	FBSS 32 x 5	2	0.316

UCFBS 60 T-TN

160 – 630A

- Bar thickness 5 & 10 mm
- Versatile support for bars 15, 20, 25 and 30 mm
- UL 94 V0
- Max. temp.: 130°C
- End cover 562710 and 562760 to cover busbar ends

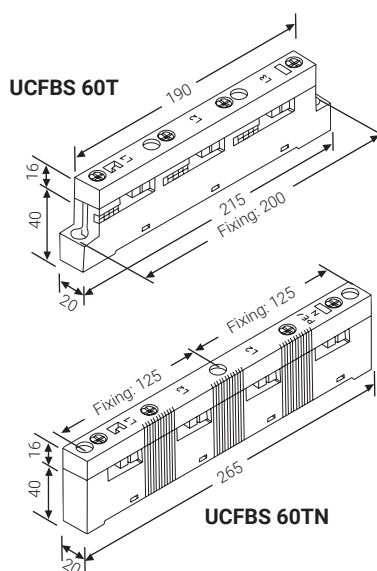

Article No.	Description				
562700	UCFBS 60 T	15-30 x 5	15-30 x 10	4	0.190
562710	UCOV 60 T			2	0.028
562750	UCFBS 60 TN	15-30 x 5	15-30 x 10	4	0.262
562760	UCOV 60 TN			2	0.034

CFBS 100 T

630 – 1200A

- Bar thickness 10 mm
- Versatile support for bars 30, 40, 50 and 60 – using the clips
- UL 94 V0
- Max. temp.: 130°C
- End cover 562810 to cover busbar ends

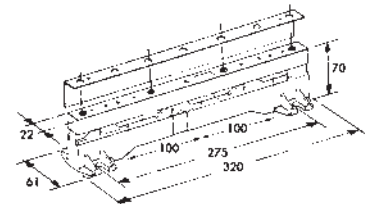

Article No.	Description		Number clip per phase		
562800	CFBS 100T	60 x 10		4	0.436
562810	COV 100T			10	0.050
562830	CLIP 100 40 x 10	40 x 10	2	24	0.004
562840	CLIP 100 50 x 10	50 x 10	2	24	0.002

Busbar Supports

ADJUSTABLE FLAT BUSBAR SUPPORTS

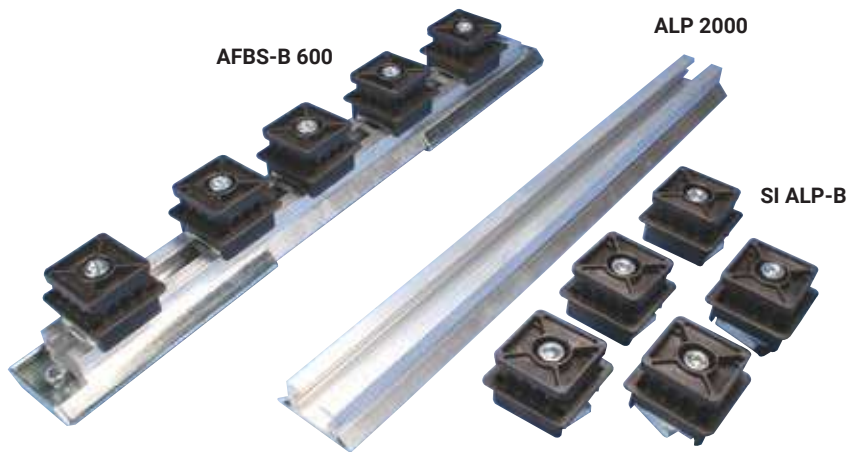

- Adjustable distance between phases
- Quick adjustment to busbar thickness 5 or 10 mm
- High resistance to short-circuit forces
- Excellent security of equipment
- Universal fixing
- Working temperature: -40°C up to 130°C
- Self extinguishing UL® 94 V0

AFBS-B 600

UP TO 1600A

- Versatile support for bars 30 to 80 mm
- For busbar thickness: 5 or 10 mm
- 3 phase + neutral circuit
- Halogen free
- See below for some applications

AFBS 600

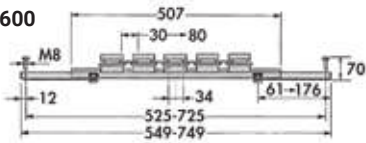

AFBS

UP TO 2300A

- Versatile support for bars 30 to 125 mm to build with: ALP 2000 aluminium rail length 2000 mm + SI ALP-B insulator blocks
- 3 phase + neutral circuit
- For busbar thickness 5 or 10 mm
- Halogen free

SI ALP-B

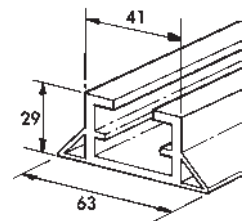

Article No.	Description		kg
504971	AFBS-B 600	1	2.200

Article No.	Description		kg
504980	ALP 2000	2	2.950
504991	SI ALP-B	12	0.258

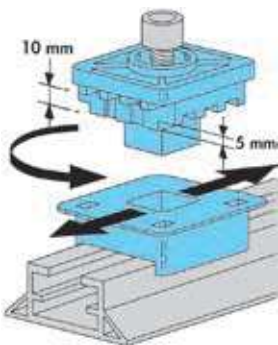

Slide and adjust to busbar thickness (5 or 10 mm) by simply rotating the insulator.

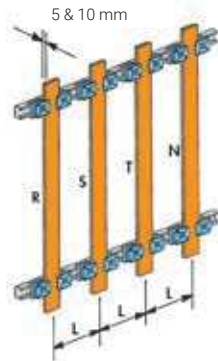

2 insulators per bar. Distance between phases can be adjusted by sliding. See nVent ERIFLEX Software.

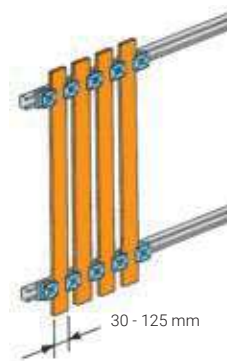

1 insulator can support 2 bars. Fixed distance between bars: 34 mm.

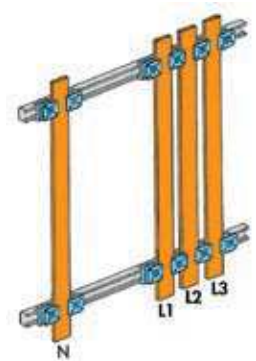

The 2 applications can be combined.

Busbar Supports

COMPACT AND REINFORCED BUSBAR SUPPORTS

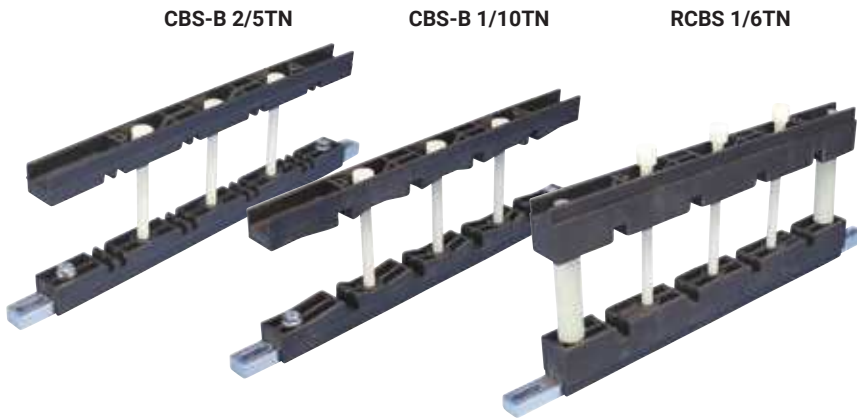

- Minimum space requirement
- Easy and quick assembly
- Fits within 400 mm depth panelboard
- Provision for direct fixing of a screen
- Halogen free
- Working temperature: -40°C up to 130°C
- Self extinguishing UL® 94 V0

CBS-B 2/5TN

250-1600A

- For bar thickness 5

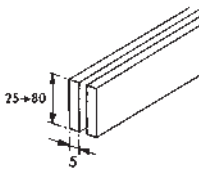
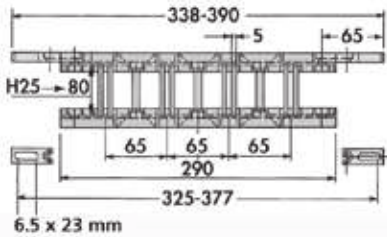

CBS-B 1/10TN

250-1600A

- For bar thickness 10 mm

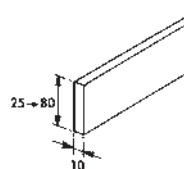
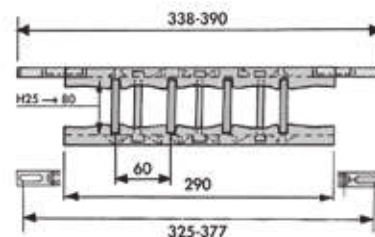

RCBS 1/6TN-1/10TN

MECHANICALLY REINFORCED

- Distance between copper bars and frame : 24 mm
- RCBS 1/6TN
- 500-1200A
- for bar thickness : 6.35 mm

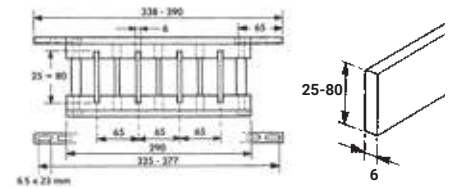

Article No.	Description	Bar thickness mm	Busbars per phase			kg
551151	CBS-B 2/5 TN	5	2	1		0.200

Article No.	Description	Bar thickness mm	Busbars per phase			kg
551181	CBS-B 1/10 TN	10	1	1		0.260

Article No.	Description	Bar thickness mm	Number of busbars per phase			kg
552050	RCBS 1/6 TN*	6	1	1		0.650

- RCBS 1/10TN
- 500-1600A
- for bar thickness : 10 mm

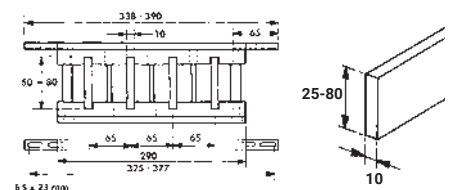

Article No.	Description	Bar thickness mm	Number of busbars per phase			kg
552070	RCBS 1/10 TN*	10	1	1		0.620

Busbar Supports

COMPACT AND ADJUSTABLE BUSBAR SUPPORTS

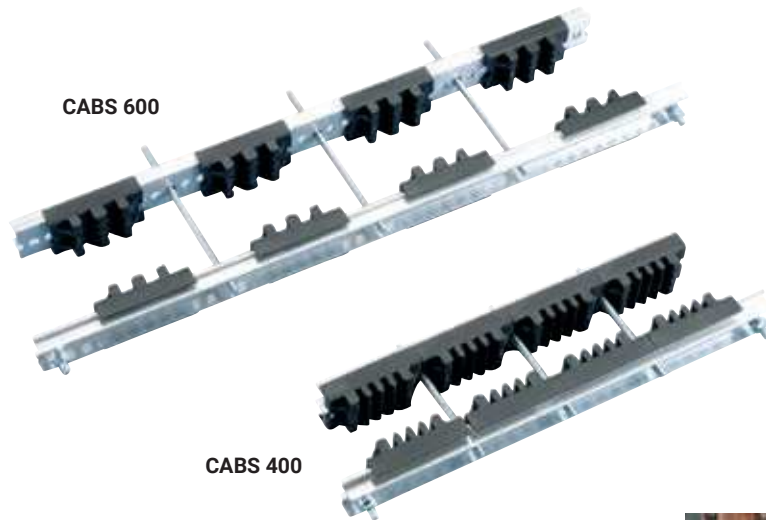

- Universal fixing support
- Easy to install
- Adjustable distance between each phase (12,5 mm pitch)
- Standard or customised support
- Cost-effective
- For all busbar types and Erilink busducts
- Halogen Free
- Working temperature: -40°C up to 130°C
- Self extinguishing UL® 94 V0



Bureau VERITAS
Certificate No. 419419 / DO BV for
shipboard use



TECHNICAL FEATURES

- Panels: 300 to 800 mm
- Bars: 30 to 125 mm
- Thickness: 5 or 10 mm
- From 400A up to 4500 A

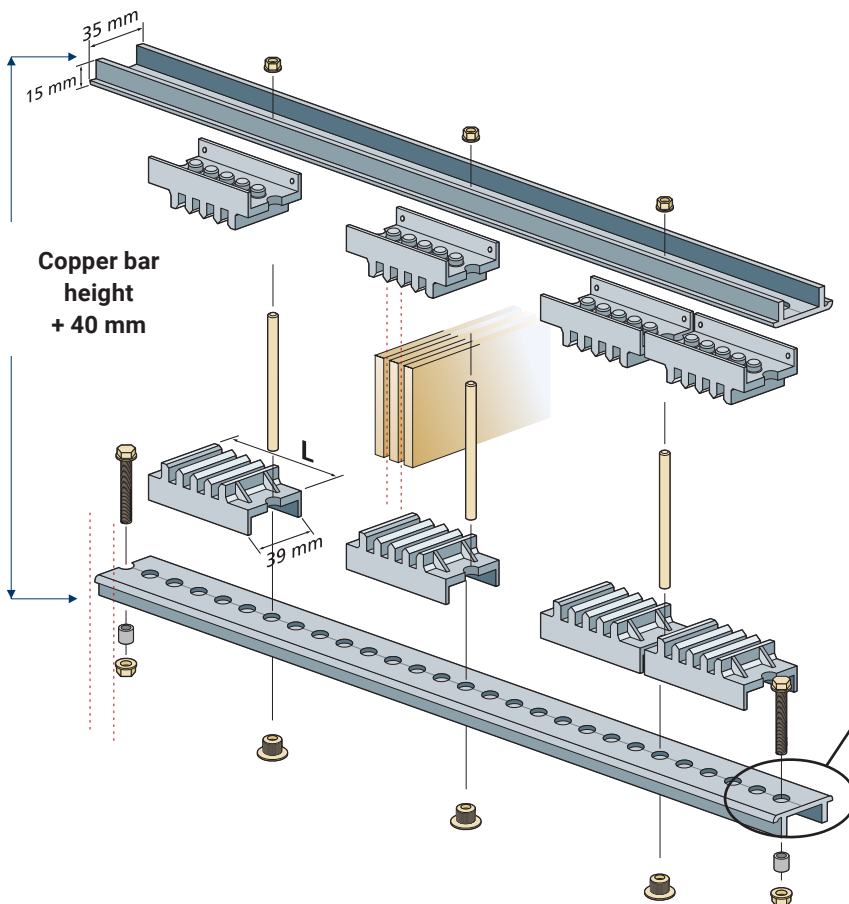

Aluminum Profile Rigidity
How to improve the Bending
Resistance, according to
your configuration:

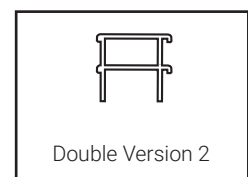
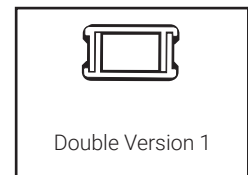
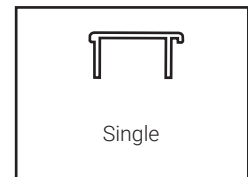

For calculation purpose:
see nVent ERIFLEX Software

Busbar Supports

COMPACT AND ADJUSTABLE BUSBAR SUPPORTS (CABS)

STANDARD CABS SUPPORTS READY TO USE:

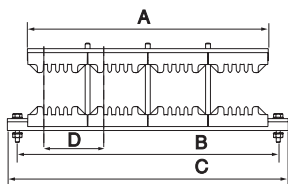

	CABS400	CABS600
A	300	500
B	325	525
C	350	550
D	75	75 → 125
4/5TN	549310	549260
2/10TN	549320	549270

Article No.	Description	Box	kg	L
549310	CABS 4/5 TN 400	1	0.800	75
549320	CABS 2/10 TN 400	1	0.770	75
549260	CABS 4/5 TN 600	1	0.840	75
549270	CABS 2/10 TN 600	1	0.810	75

CUSTOMIZED SUPPORT: JUST 3 PARTS

LESS PARTS... MORE CONFIGURATIONS:

1 Aluminum Profile 2M (CABS App)

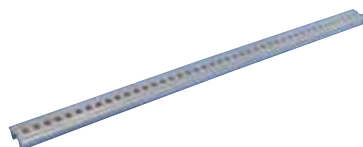

Article No.	Description	Box	kg
549300	CABS APP	2	0.90

2 6 CABS Modules:

CABS 4/5 T MODULE:
1 to 4 BARS
30 → 125 x 5 mm

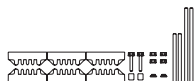

CABS 2/10 T MODULE:
1 to 2 BARS
30 → 120 x 10 mm

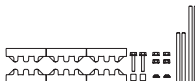

CABS 3/10 T MODULE:
1 to 3 BARS
30 → 120 x 10 mm

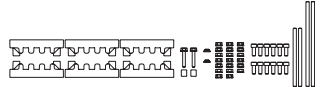

CABS 4/5 TN MODULE:
1 to 4 BARS
30 → 125 x 5 mm

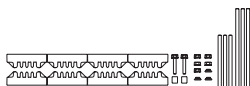

CABS 2/10 TN MODULE:
1 to 2 BARS
30 → 120 x 10 mm

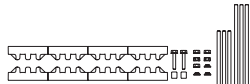

CABS 3/10 TN MODULE:
1 to 3 BARS
30 → 120 x 10 mm

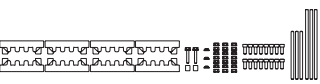

T = 3 Phases

Article No.	Description	Box	kg	L
549370	CABS 4/5 T MOD	1	0.39	75
549380	CABS 2/10 T MOD	1	0.37	75
549390	CABS 3/10 T MOD	1	0.45	100

TN = 3 Phases + Neutral

Article No.	Description	Box	kg	L
549340	CABS 4/5 TN MOD	1	0.50	75
549350	CABS 2/10 TN MOD	1	0.48	75
549360	CABS 3/10 TN MOD	1	0.58	100

3 ACCESSORIES: BRACKETS FOR SUPPORTS FIXING

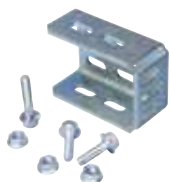

BRACKET CABS M



BRACKET CABS T KIT



BRACKET CABS E

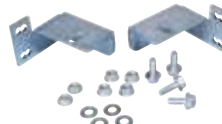

BRACKET CABS TH KIT



BRACKET CABS SV



BRACKET CABS RV



ADD. KIT CABS Fixing

Article No.	Description	Box	kg
549450	CABS Bracket TH Kit	5	0.250
549470	CABS Bracket SV	10	0.050
549480	CABS Bracket RV	10	0.060
549400	CABS T SET	5	0.110
549410	CABS E	10	0.046
549420	CABS M	10	0.200
549430	ADD. Kit CABS Fixing	1	0.310

Busbar Supports

COMPACT AND ADJUSTABLE BUSBAR SUPPORTS (CABS)

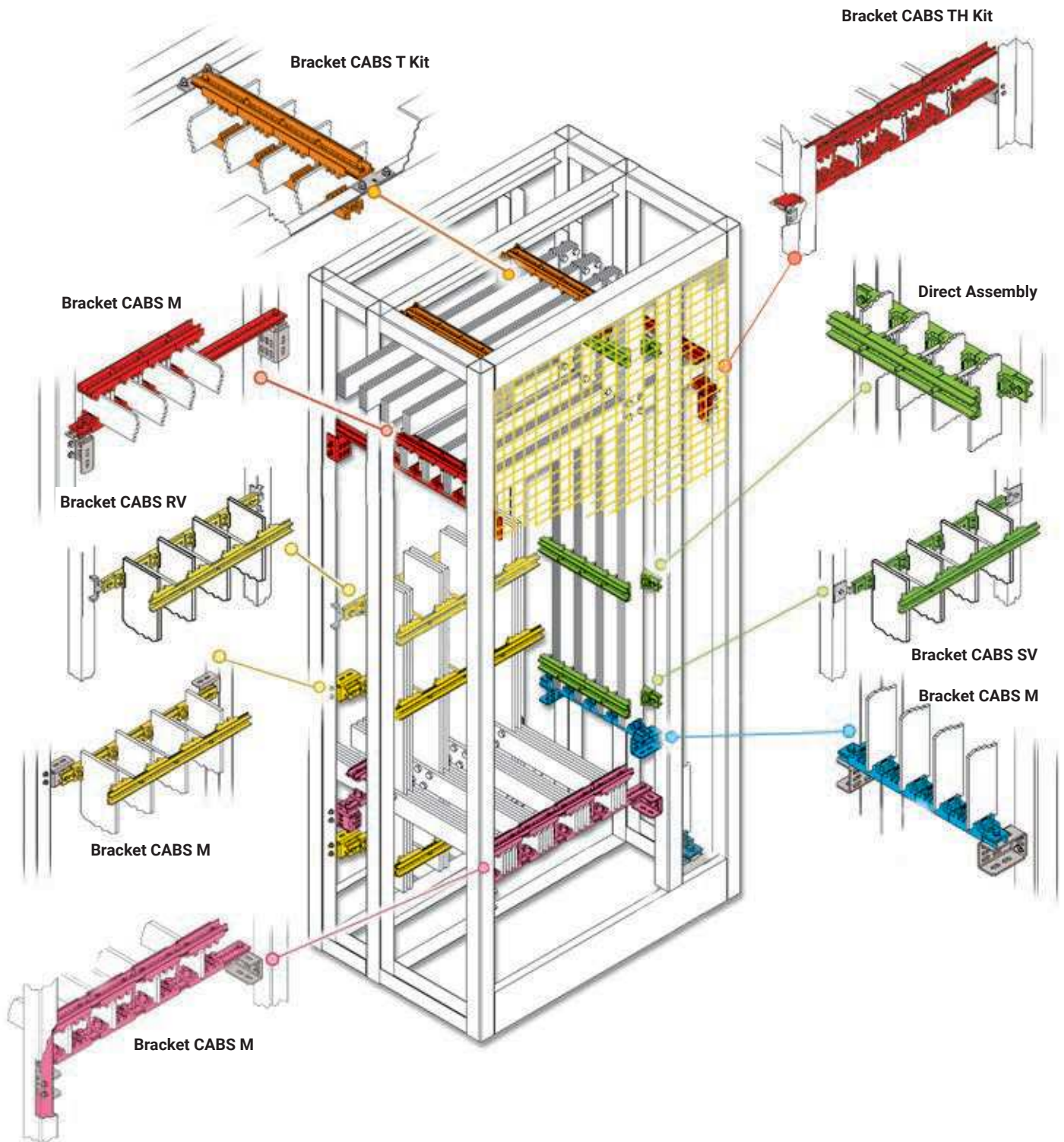

Busbar Supports

UNIVERSAL BUSBAR SUPPORTS

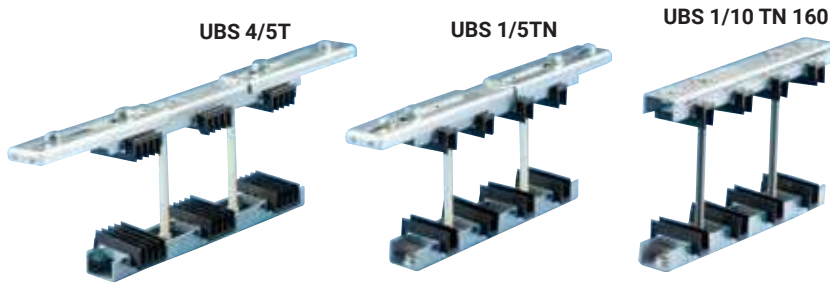

- Complete range of 15 supports
- Extremely robust construction
- Universal fixing system
- Time saving during mounting procedure
- Halogen free insulators
- Working temperature: -40°C up to 130°C
- Self extinguishing UL® 94 VO

 Bureau VERITAS
Certificate No. 419419 / DO BV for
shipboard use

TECHNICAL CHARACTERISTICS



- (1) 2,5 mm reinforced and formed zinc plated steel sheet
- (2) Insulators in polyamide, glass fiber reinforced, halogen free
- (3) Busbars fixed and tightened using reinforced polyamide M10 screws (in stainless steel for bars 160 and 200 mm)
- (4) Adjustable distance between fixing centers
- (5) Distance between lateral fixing centers: 25 mm
- (6) Provision for direct fixing of a screen using 2 M10 integrated flush nuts

UBS 1/5TN

1700A

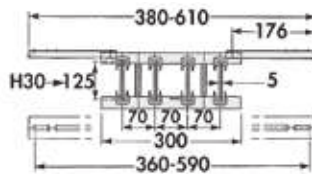
- 3 phase + neutral circuit
- Busbar thickness: 5 mm
- Busbar width: 30 to 125 mm





Article No.	Description	Number of busbars per phase		
551000	UBS 1/5 TN	1	1	1.86

UBS 1/10TN

2250A

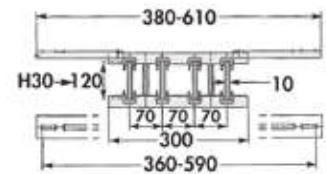
- 3 phase + neutral circuit
- Busbar thickness: 10 mm
- Busbar width: 30 to 120 mm



Article No.	Description	Number of busbars per phase		
551060	UBS 1/10 TN*	1	1	1.86

T = 3 phases
TN = 3 phases + neutral

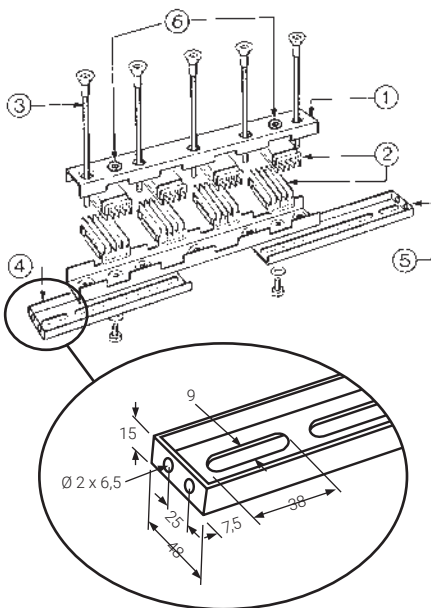



UBS 4/5T & 4/5TN

3500A

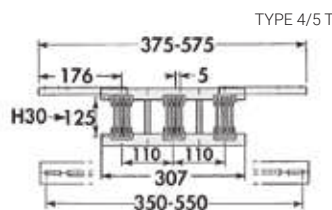
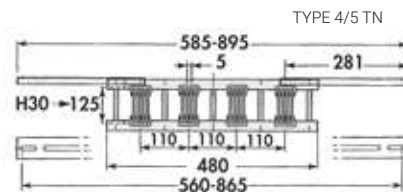
- 3 phase (4/5 T)
- 3 phase + neutral circuit (4/5 TN)
- Busbar thickness: 5 mm
- Busbar width: 30 to 125 mm



Article No.	Description	Number of busbars per phase		
551010	UBS 4/5 TN	1-4	1	2.88
551020	UBS 4/5 T	1-4	1	2.22

UBS 1/10TN 160 & 200

3500A

- 3 phase + neutral circuit
- Busbar thickness: 10 mm
- Busbar width: 160 to 200 mm
- Assembling without extension arms

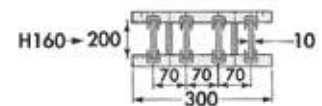

Article No.	Description	Number of busbars per phase		
561500	UBS 1/10 TN 160	1	1	2.30

Busbar Supports

UNIVERSAL BUSBAR SUPPORTS



UBS 2/10TN 200



UBS 2/10TN



UBS 2/10T



UBS 2/10T

3600A

- 3 phase
- Busbar thickness: 10 mm
- Busbar width: 30 to 120 mm

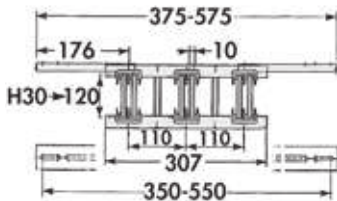

UBS 2/10TN

3600A

- 3 phase + neutral circuit
- Busbar thickness: 10 mm
- Busbar width: 30 to 120 mm

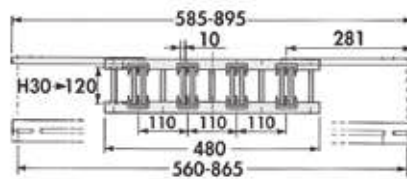

UBS 3/10TN

4500A

- 3 phase + neutral
- Busbar thickness: 10 mm
- Busbar width: 30 to 120 mm

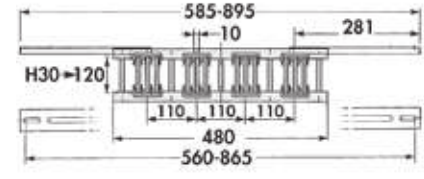

Article No.	Description	Number of busbars per phase			kg
551080	UBS 2/10 T	1-2	1		2.18

Article No.	Description	Number of busbars per phase			kg
551070	UBS 2/10 TN	1-2	1		2.86

Article No.	Description	Number of busbars per phase			kg
551090	UBS 3/10 TN	1-3	1		2.90

UBS 2/10T 160 & 200

5700A

- 3 phase
- Busbar thickness: 10 mm
- Busbar width: 160 to 200 mm
- Assembling without extension arms

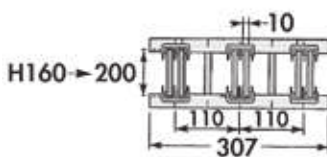

UBS 2/10TN 160 & 200

5700A

- 3 phase + neutral circuit
- Busbar thickness: 10 mm
- Busbar width: 160 to 200 mm
- Assembly without extension arms

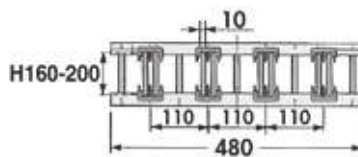

UBS 3/10TN 160 & 200

7400A

- 3 phase + neutral circuit
- Busbar thickness: 10 mm
- Busbar width: 160 to 200 mm
- Assembling without extension arms

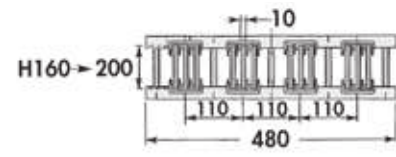

Article No.	Description	Number of busbars per phase			kg
561520	UBS 2/10 T 160	1-2	1		2.60

Article No.	Description	Number of busbars per phase			kg
561870	UBS 2/10 TN 160	1-2	1		3.40
561880	UBS 2/10 TN 200	1-2	1		3.50

Article No.	Description	Number of busbars per phase			kg
561540	UBS 3/10 TN 160	1-3	1		3.40

Busbar Supports

ADJUSTABLE BUSBAR SUPPORT

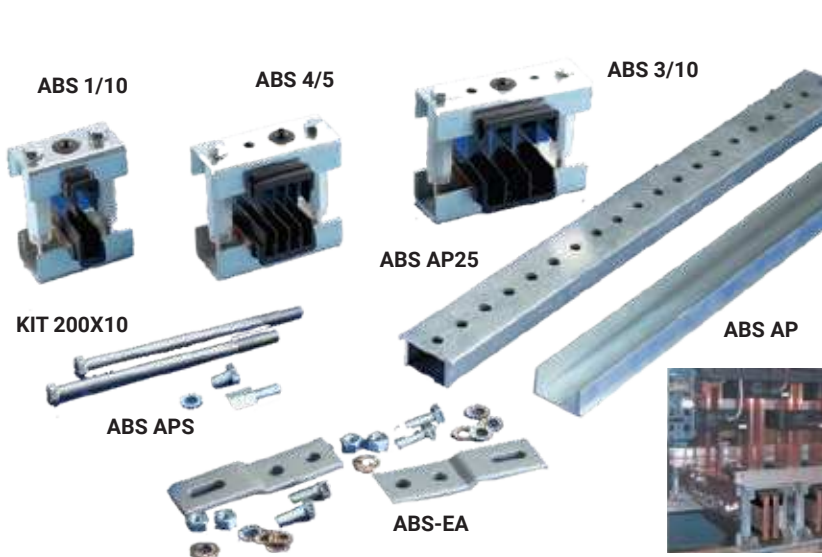

- Freedom to select the desired distance
- Extremely robust construction
- Universal fixing system
- Time saving due to rapid assembly process
- Working temperature: -40°C up to 130°C
- Halogen free
- Self extinguishing UL® 94 V0

ABS

OFFERING REAL SIMPLICITY WITH JUST 2 COMPONENTS:

- 1 – Aluminum profiles 2 m
- 2 – Single kits enabling phase assembly

• Up To 7400 A

- Panels: 300 to 900 mm
- Bars: 50 to 200 mm
- Thickness: 5 or 10 mm
- Busbars IP 00 / Erilink

FREEDOM WITH WHICH TO SELECT:

- The desired distance between each phase
- The desired configuration: bipolar, tripolar, tetrapolar

1 Aluminum Profiles 2M 2 different options:

- Punched 25 mm holes pitch
- Plain to be drilled

2 Single Kits Enabling Phase Assembly 5 different modules:

- 1/5: 1 bar 50-125 x 5 mm per phase
- 4/5: 2,3,4 bars 50-125 x 5 mm per phase
- 1/10: 1 bar 50-120 x 10 mm per phase*
- 2/10: 2 bars 50-120 x 10 mm per phase*
- 3/10: 3 bars 50-120 x 10 mm per phase*

Aluminum Profile Rigidity
How to improve the Bending Resistance, according to your configuration:

For calculation purpose: see nVent ERIFLEX Software

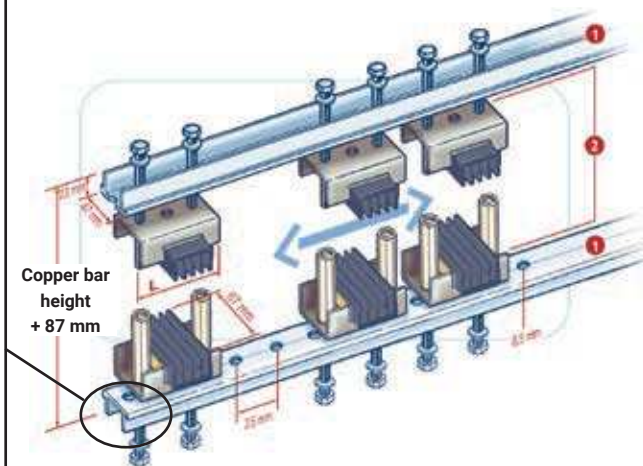

Article No.	Description	Designation	kg	L
560930	ABS AP25	ABS perfo alu profile 25	2	1.35
560940	ABS AP	ABS alu profile	2	1.37
560860	ABS 1/5	ABS module 1/5	1	0.64 74
560870	ABS 4/5	ABS module 4/5	1	0.73 99
560880	ABS 1/10	ABS module 1/10	1	0.64 74
560890	ABS 2/10	ABS module 2/10	1	0.73 99
560900	ABS 3/10	ABS module 3/10	1	0.81 124
560910	ABS 160 x 10	ABS kit 160 x 10	1	0.12
560920	ABS 200 x 10	ABS kit 200 x 10	1	0.16
560950	ABS APS	ABS profile stiffener kit	1	0.045
560960	ABS-EA	ABS Erilink Erilink adaptor	1	0.170

ACCESSORIES

*In Addition To The Above Modules

- Kit 160 x 10 (for 160 x 10 copper bar)
- Kit 200 x 10 (for 200 x 10 copper bar)

In Addition To The Above Aluminum Profiles:

- Profile stiffener kit (ABS APS)
- Combined profile reinforced
- Aluminum profile fixing with panel

Spacers and Accessories

- A complete range of accessories for easy distribution block assembly

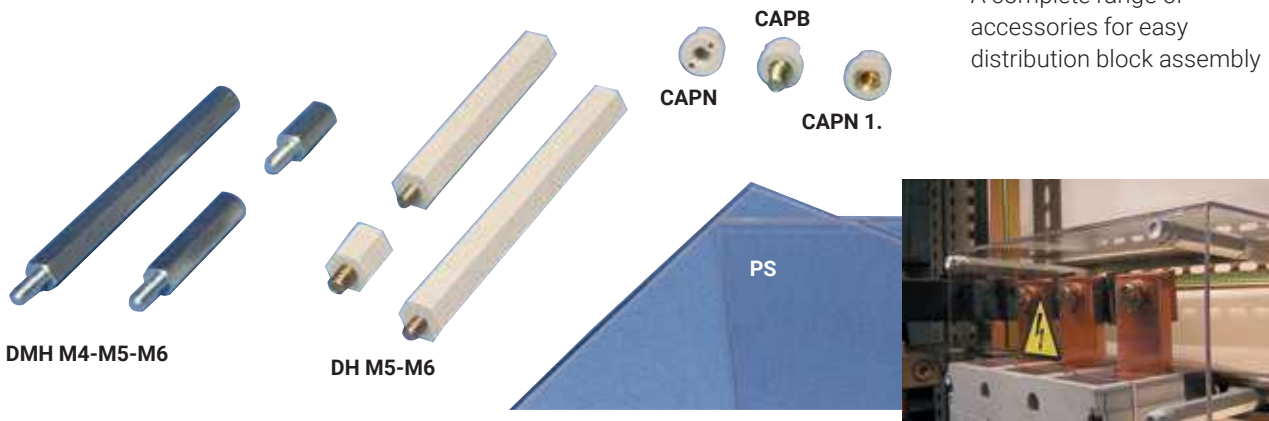

DMH M4-M5-M6

METALLIC SPACERS

- Metallic hexagonal spacers
- Zinc plated steel
- To make higher plates, screens or profiles
- Male-female allowing stable mounting
- See drawing on DH

Article No.	Description	L mm	Ø mm	A mm	B mm	kg
561560	DMH 10M4	10	M4	8-10	7	100
561570	DMH 15M4	15	M4	8-10	7	100
561580	DMH 20M4	20	M4	8-10	7	100
561590	DMH 25M4	25	M4	8-10	7	50
561600	DMH 30M4	30	M4	8-10	7	50
561610	DMH 35M4	35	M4	8-10	7	50
561620	DMH 40M4	40	M4	8-10	7	50
561630	DMH 50M4	50	M4	8-10	7	50
561640	DMH 60M4	60	M4	8-10	7	25

561660	DMH 15M5	15	M5	10	8	50
561670	DMH 20M5	20	M5	10	8	50
561680	DMH 25M5	25	M5	10	8	50
561690	DMH 30M5	30	M5	10	8	50
561700	DMH 35M5	35	M5	10	8	25
561710	DMH 40M5	40	M5	10	8	25
561720	DMH 50M5	50	M5	10	8	25
561730	DMH 60M5	60	M5	10	8	25
561740	DMH 70M5	70	M5	10	8	25
561750	DMH 80M5	80	M5	10	8	25

561760	DMH 15M6	15	M6	10	10	50
561770	DMH 20M6	20	M6	12	10	50
561780	DMH 30M6	30	M6	12	10	25
561790	DMH 40M6	40	M6	12	10	25
561800	DMH 50M6	50	M6	12	10	25
561810	DMH 60M6	60	M6	12	10	25
561820	DMH 70M6	70	M6	12	10	25
561830	DMH 80M6	80	M6	12	10	25
561840	DMH 90M6	90	M6	12	10	25
561850	DMH 100M6	100	M6	12	10	10

DH M5-M6

SPACERS

- Male-female
- Electrotechnical applications
- Insulating part made from polystyrol
- Threaded-end, made from zinc-plated steel
- Working temperature up to 80°C
- Insulation voltage 1000 V

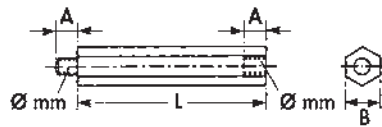

Article No.	Description	L mm	Ø mm	A mm	B mm	kg
560660	DH 15M5	15	M5	7	13	100
560670	DH 20M5	20	M5	7	13	100
560600	DH 30M5	30	M5	7	13	100
560610	DH 45M5	45	M5	7	13	100
560620	DH 55M5	55	M5	7	13	100
560630	DH 70M5	70	M5	7	13	100
560640	DH 85M5	85	M5	7	13	100
560650	DH 120M5	120	M5	7	13	100

560740	DH 15M6	15	M6	7-8	13	100
560750	DH 20M6	20	M6	7-8	13	100
560700	DH 30M6	30	M6	7-8	13	100
560710	DH 45M6	45	M6	7-8	13	100
560720	DH 70M6	70	M6	7-8	13	100
560730	DH 120M6	120	M6	7-8	13	100

CAPN-CAPB

CAP NUTS

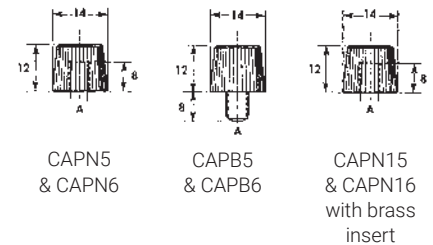

Article No.	Description	A	kg
560800	CAPN5	M5	100
560810	CAPN6	M6	100
560820	CAPN15	M5	100
560830	CAPN16	M6	100
560840	CAPB5	M5	100
560850	CAPB6	M6	100

PS

PROTECTION SCREEN (MADE FROM PVC)

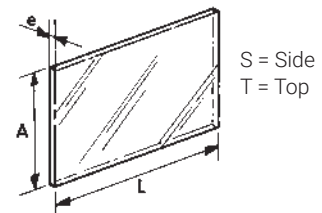

Article No.	Description	L mm	A mm	e mm	Mounts to	kg
563120	PS1000 x 60 x 3	1000	60	3	BSC 125A/S	10
551330	PS500 x 126 x 3	500	126	3	BS 125A/T	10
551260	PS1000 x 250 x 3	1000	250	3	BS 400/T	1
551280	PS1000 x 2000 x 3	1000	2000	3	-	1

Insulators

ISO-TP LOW VOLTAGE METRIC INSULATORS



- Working temperature -40°C up to 130°C
- Polyamide material reinforced with glass fiber
- Halogen free
- Zinc plated steel inserts, threaded to ISO standard
- Great stability of electrical and mechanical parameters
- Self-extinguishing: UL® 94 V0

Article No.	Description	Dimensional characteristics						Nominal Voltage		Mechanical		kg	
		H mm	Ch mm	ØF mm	h1 mm	ØD mm	P mm	Alternating V	Direct V	Tensile strength ▲ daN	Bending strength ► daN		
548400	ISO TP 15M4	15	14	M4 X 0.7	4	12	16	500	500	150	100	50	0.005
548410	ISO TP 20M4	20	17	M4 X 0.7	4	15	20	1000	1500	150	100	50	0.008
548420	ISO TP 20M6	20	17	M6 X 1	6	15	20	1000	1500	150	100	50	0.012
548700	ISO TP 25M5	25	19	M5 X 0.8	6	18	20	1000	1500	300	160	50	0.016
548430	ISO TP 25M6	25	19	M6 X 1	6	18	20	1000	1500	300	160	50	0.016
548440	ISO TP 30M6	30	30	M6 X 1	8	26	34	1000	1500	600	300	25	0.034
548450	ISO TP 30M8	30	30	M8 X 1.25	8	26	34	1000	1500	600	300	25	0.046
548451	ISO TP 30M10	30	30	M10 X 1.5	10	26	34	1000	1500	600	300	25	0.046
548470	ISO TP 35M6L	35	41	M6 X 1	8	34	46	1000	1500	1100	500	25	0.062
548480	ISO TP 35M8	35	41	M8 X 1.25	8	34	46	1000	1500	1100	800	25	0.074
548490	ISO TP 35M10	35	41	M10 X 1.5	10	34	46	1000	1500	1100	800	25	0.092
548500	ISO TP 40M6	40	46	M6 X 1	9	40	53	1000	1500	1100	800	25	0.098
548510	ISO TP 40M8	40	46	M8 X 1.25	8	40	53	1000	1500	1100	800	25	0.104
548520	ISO TP 40M10	40	46	M10 X 1.5	10	40	53	1000	1500	1100	450	25	0.102
548511	ISO TP 40M12	40	46	M12 X 1.75	14.5	40	53	1000	1500	1100	450	25	0.102
548530	ISO TP 45M6	45	41	M6 X 1	9	34	47	1000	1500	1100	650	25	0.104
548540	ISO TP 45M8	45	41	M8 X 1.25	15	34	47	1000	1500	1100	650	25	0.136
548550	ISO TP 45M8L	45	50	M8 X 1.25	15	41	57	1000	1500	1800	1000	25	0.132
548560	ISO TP 45M10	45	50	M10 X 1.5	10	41	57	1000	1500	1800	700	25	0.116
548570	ISO TP 50M6	50	50	M6 X 1	9	41	57	1000	1500	2000	700	25	0.152
548580	ISO TP 50M8	50	50	M8 X 1.25	15	41	57	1000	1500	2000	1000	25	0.148
548590	ISO TP 50M10	50	50	M10 X 1.5	10	41	57	1000	1500	2000	1000	25	0.196
548581	ISO TP 50M12	50	50	M12 X 1.75	14.5	41	57	1000	1500	2000	1000	25	0.190
548600	ISO TP 60M8	60	55	M8 X 1.25	15	44	63	1000	1500	2200	1000	25	0.192
548610	ISO TP 60M10	60	55	M10 X 1.5	10	44	63	1000	1500	2200	1000	25	0.380
548601	ISO TP 60M12	60	55	M12 X 1.75	14.5	44	63	1000	1500	2200	1000	25	0.360
548602	ISO TP 60M16	60	55	M16 X 2	20	44	63	1000	1500	2200	1000	25	0.350
548609	ISO TP 70M10	70	65	M10 X 1.5	10	52	75	1000	1500	2200	1000	10	0.480
548620	ISO TP 70M12	70	65	M12 X 1.75	20	52	75	1000	1500	2500	1600	10	0.470
548630	ISO TP 70M16	70	65	M16 X 2	20	52	75	1000	1500	2500	1600	10	0.374
548629	ISO TP 75M10	75	65	M10 X 1.5	10	51	75	1000	1500	2200	1000	10	0.530
548640	ISO TP 75M12	75	65	M12 X 1.75	20	51	75	1000	1500	3000	1600	10	0.470
548650	ISO TP 75M16	75	65	M16 X 2	20	51	75	1000	1500	3000	1600	10	0.382
548660	ISO TP 80M12	80	65	M12 X 1.75	20	52	75	1000	1500	3000	1600	10	0.510
548670	ISO TP 80M16	80	65	M16 X 2	20	52	75	1000	1500	3000	1600	10	0.404
548680	ISO TP 100M12	100	65	M12 X 1.75	14	46	75	1000	1500	3000	1000	10	0.476
548690	ISO TP 100M16	100	65	M16 X 2	20	46	75	1000	1500	3000	1500	10	0.508

- CE Conformity
- RoHS 2002/95/EC Compliance
- IEC compliance
- UL Recognized in E125470 and evaluated for dielectric withstand rating of 1500 Vac/Vdc
- EAC

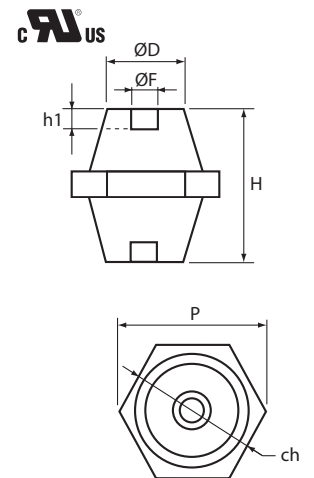

ISOBOLT

INSULATOR MOUNTING KITS

- Complete with stud, washer, lock washer, nut
- ISO® M sizes
- Zinc plated steel

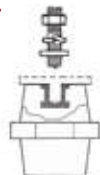

Article No.	Description	Thread	Length mm	kg
552200	ISOBOLT 25 M6	M6	25	0.008
552220	ISOBOLT 30 M8	M8	30	0.017

Insulators

LOW VOLTAGE METRIC MALE / FEMALE INSULATORS



- Working temperature -40°C up to 130°C
- Polyamide material reinforced with glass fiber
- Halogen free
- Zinc plated steel inserts, threaded to ISO standard
- Great stability of electrical and mechanical parameters
- Self-extinguishing: UL® 94 VO

Article No.	Description	Dimensional characteristics								Nominal Voltage		Mechanical		kg	
		H mm	Ch mm	$\varnothing F1$ mm	H1 mm	$\varnothing F2$ mm	H2 mm	$\varnothing D$ mm	P mm	Alternating V	Direct V	Tensile strength \uparrow daN	Bending strength \rightarrow daN		
542030	ISO TP 30 MM8X17/FM8X8	30	30	M 8 X 1.25	8	M 8 X 1.25	17	26	34	1000	1500	600	300	25	0.05
542050	ISO TP 40 MM8X17/FM8X8	40	46	M 8 X 1.25	8	M 8 X 1.25	17	40	53	1000	1500	1100	650	25	0.11
542070	ISO TP 50 MM8X17/FM8X15	50	50	M 8 X 1.25	15	M 8 X 1.25	17	41	57	1000	1500	2000	1000	25	0.15
542080	ISO TP 60 MM8X17/FM8X15	60	55	M 8 X 1.25	15	M 8 X 1.25	17	44	63	1000	1500	2200	1000	25	0.19
542110	ISO TP 80 MM8X17/FM8X15	80	65	M 8 X 1.25	15	M 8 X 1.25	17	52	75	1000	1500	2200	1000	10	0.35
542120	ISO TP 100 MM12X25/FM12X20	100	65	M12 X 1.75	20	M12 X 1.75	20	46	75	1000	1500	3000	1000	10	0.51

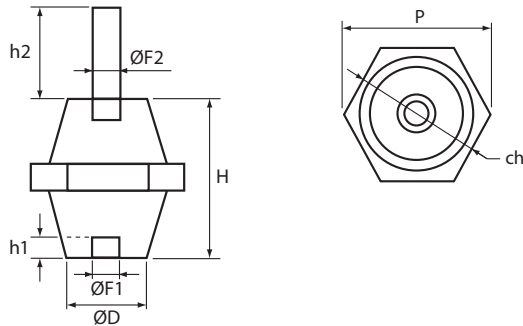

- CE Conformity
- RoHS 2002/95/EC Compliance
- IEC compliance
- UL Recognized in E125470 and evaluated for dielectric withstand rating of 1500 Vac/Vdc
- EAC



Sleeves

CABLING SLEEVES

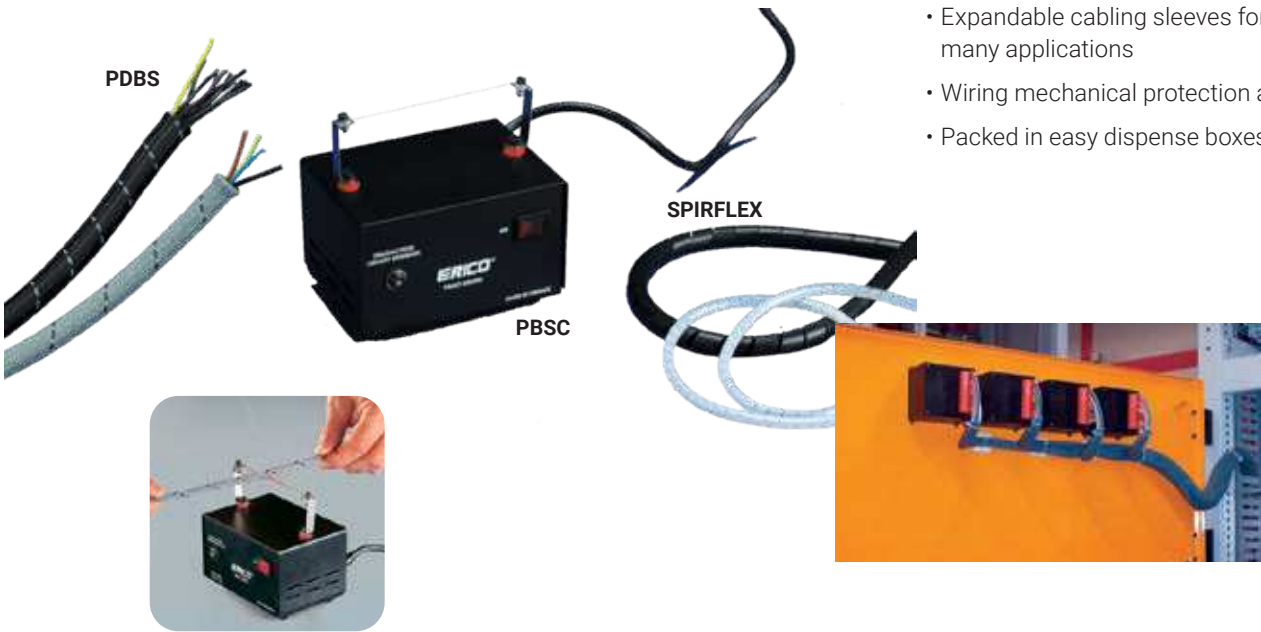

- Expandable cabling sleeves for many applications
- Wiring mechanical protection aesthetic
- Packed in easy dispense boxes

PDBS

POLYAMIDE 6/6 BRAIDED SLEEVES

- Highly expandable
- Provide complete wire coverage up to Ø 80 mm
- Halogen free
- Compact range: 10 parts only
- 2 colors: grey or black

	Polyamide
Density (Kg/dm ³)	1,14
Min. working T°	- 40°C
Max. working T°	+ 120°C
Max. T° 1s	240°C
Self-extinguishing	UL 94 V2

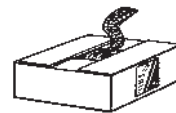

PBSC

CUTTING TOOL FOR BRAIDED SLEEVES

- Hot-wire cutter for clean cutting
- The wire ends are welded together 230 V supply

Article No.	Description	Size		kg
559590	PBSC	125 x 90 x H60 mm	1	0.45
559580	PBSCW (wire)	length 5 m	1	0.01

SPIRFLEX

SPIRFLEX SPIRAL SLEEVES

- Expandable cabling sleeves for many applications
- Spiral structure allow cables to branch out at any point
- Flexible bundling and mechanical protection of electrical cables and wires
- Packed in easy dispense boxes
- Halogen free
- Working Temperature: -50 to 85 °C
- Flammability Rating: UL® 94V-0

Article No.	Description Grey	Part No.	Description Black	Diameter (mm)							kg
				Nom.	Covering %	Min.	Covering %	Max.	Covering %		
554430	PDBS 5G	554730	PDBS 5B	5	97%	4	100%	8	90%	100	0.004
554450	PDBS 8G	554750	PDBS 8B	8	94%	6	100%	10	91%	100	0.006
554460	PDBS 10G	554760	PDBS 10B	10	95%	8	100%	14	94%	100	0.008
554470	PDBS 12G	554770	PDBS 12B	12	96%	10	100%	16	94%	50	0.010
554490	PDBS 16G	554790	PDBS 16B	16	96%	14	100%	18	98%	50	0.013
554510	PDBS 20G	554810	PDBS 20B	20	95%	16	100%	25	99%	50	0.018
554530	PDBS 30G	554830	PDBS 30B	30	90%	20	100%	35	92%	50	0.027
554550	PDBS 40G	554850	PDBS 40B	40	90%	30	100%	45	94%	50	0.036

* ON REQUEST:

- Polyester Sleeves
- Rilsan Sleeves
- Other Material On Study

Article No.	Description	Internal dia. mm	Color		kg
556000	Spirflex I 6	6	black	50 m	0.017
556010	Spirflex I 12	12	black	25 m	0.042
556020	Spirflex I 16	16	black	25 m	0.11
556030	Spirflex I 22	22	black	25 m	0.12
556100	Spirflex X 6	6	white	50 m	0.017
556110	Spirflex X 12	12	white	25 m	0.042

Sleeves

CABLING SLEEVES

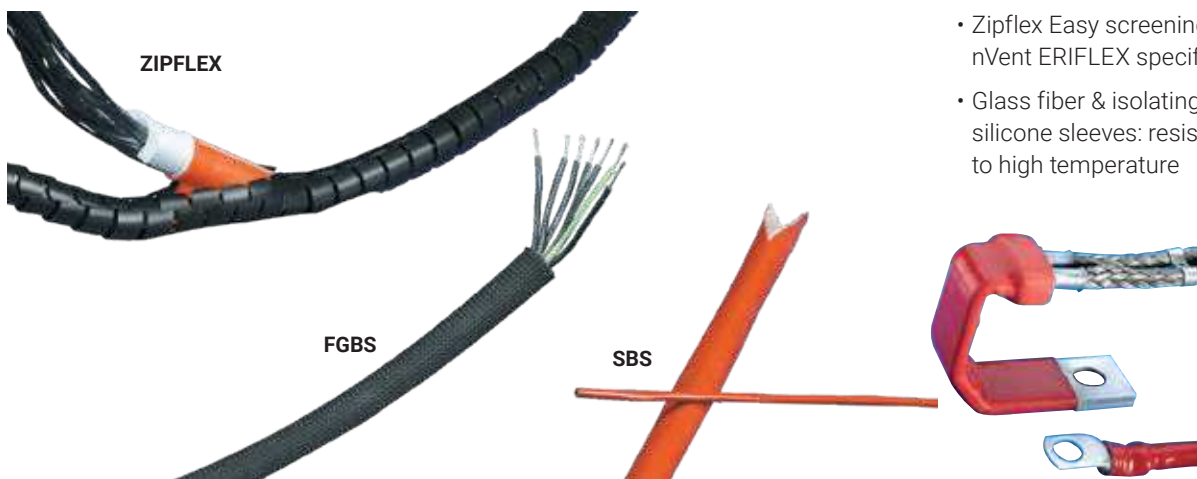

- Zipflex Easy screening using nVent ERIFLEX specific tool
- Glass fiber & isolating silicone sleeves: resistant to high temperature

ZIPFLEX

ZIPFLEX SLEEVES

- Polypropylene
- Easy and quick screening
- Practical tool included in every box
- Color: black
- Usage maxi: T° 140°C
- Usage mini: T° -30°C
- Continue: T° -30 till + 110°C
- Halogen free
- UL 94HB



FGBS

GLASS FIBER BRAIDED SLEEVES

- Glass fiber impregnated with high temperature varnish
- Thermal insulation and mechanical protection
- Working temperature: -70°C up to 400°C
- Halogen free
- Flammability UL 1441 VW1
- Expandable on a 1 to 3 ratio basis

Article No.	Description	Nominal dia. mm	Max expanded dia. mm	Box	kg
556200	FGBS 4	4	12	100 m	0.010
556210	FGBS 8	8	24	100 m	0.014
556220	FGBS 10	10	30	100 m	0.016
556230	FGBS 12	12	36	100 m	0.018
556240	FGBS 15	15	45	50 m	0.030
556250	FGBS 20	20	60	50 m	0.044

SBS



ISOLATING SILICONE SLEEVES

- Glass fiber coated with silicone
- Cost effective sleeve for insulation
- High flexibility
- Dielectric voltage: 2.5 Kv
- Working temperature: -60° up to 220°C
- Halogen free
- Flammability UL 1441 VW1
- Max Working Voltage, IEC and UL: 690 VAC/DC

Article No.	Description	Internal dia. mm	Box	kg
554000	SBS 4	4	100 m	0.020
554010	SBS 6	6	100 m	0.038
554020	SBS 8	8	100 m	0.050
554030	SBS 10	10	100 m	0.054
554040	SBS 12	12	100 m	0.070
554050	SBS 15	15	25 m	0.111
554060	SBS 20	20	25 m	0.148
554070	SBS 25	25	30 m	0.185
554080	SBS 30	30	30 m	0.222

Article No.	Description	Internal dia. mm	Box	kg
554880	Zipflex 8	8	100 m	0.015
554890	Zipflex 15	15	50 m	0.044
554900	Zipflex 20	20	30 m	0.070
554910	Zipflex 25	25	20 m	0.100

Profiles / DIN Rail

STEEL PROFILES

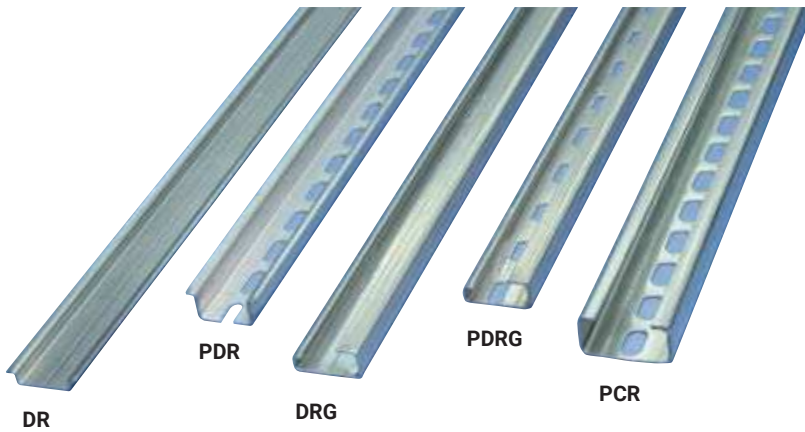

- Zinc plated steel
- Rapid assembly of all kinds of frameworks
- High mechanical resistance
- High corrosion resistance
- Conforms to EN60715, EN50022, EN50035 and DIN46277
- RoHS Compliant

DR

SYMMETRIC PROFILES

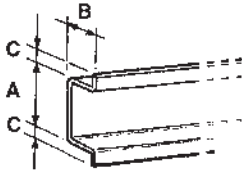

Article No.	Description	Thickness mm	A mm	B mm	C mm	Lg mm	kg	
557700	DR 5.5 2 m	1	10.5	5.5	2	2	15	0.33
557800	DR 7 2 m	1	27	7.5	4	2	15	0.66
557810	DR 7 3 m	1	27	7.5	4	3	10	0.99
557900	DR 15 2 m	1.5	27	15	4	2	15	1.30
557910	DR 15 3 m	1.5	27	15	4	3	10	1.95

DRG

ASYMMETRIC PROFILES

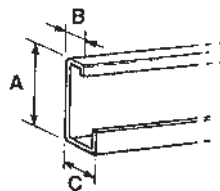

Article No.	Description	Thickness mm	A mm	B mm	C mm	Lg mm	kg	
558000	DRG 2 m	1.5	32	9	15	2	15	1.40
558010	DRG 3 m	1.5	32	9	15	3	10	2.10

PCR

PERFORATED C-SHAPED PROFILES

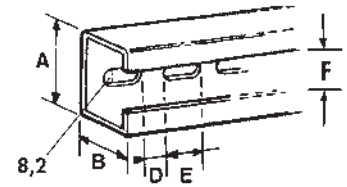

Article No.	Description	Thickness mm	A mm	B mm	C mm	D mm	E mm	Lg mm	kg	
557520	PCR 35 x 35 2 m	2	35	35	7	18	16	2	10	3
557500	PCR 40 x 20 2 m	1.5	40	20	7	18	24	2	12	2.5
557780	PCR 30 x 15 3 m	1.5	30	15	7	18	15	3	10	2.4
557790	PCR 35 x 35 3 m	2	35	35	7	18	16	3	10	4.5

PDR

PERFORATED SYMMETRIC PROFILES

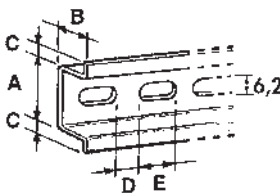

Article No.	Description	Thickness mm	A mm	B mm	C mm	D mm	E mm	Lg mm	kg	
557750	PDR 5.5 2 m	1	10.5	5.5	2	7.8	12.22	15	0.28	
557850	PDR 7 2 m	1	27	7.5	4	7	18	2	15	0.62
557855	PDR 7 2 m*	1	27	7.5	4	11	25	2	15	0.62
557860	PDR 7 3 m	1	27	7.5	4	7	18	3	10	0.92
557950	PDR 15 2 m	1.5	27	15	4	7	18	2	15	1.20
557960	PDR 15 3 m	1.5	27	15	4	7	18	3	10	1.81

* New Parts, slot width 5.2 mm

PDRG

PERFORATED ASYMMETRIC PROFILES

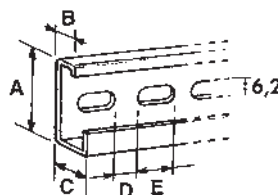

Article No.	Description	Thickness mm	A mm	B mm	C mm	D mm	E mm	Lg mm	kg	
558050	PDRG 2 m	1.5	32	9	15	7	18	2	15	1.30
558060	PDRG 3 m	1.5	32	9	15	7	18	3	10	1.96

Profiles

ACCESSORIES AND TOOL

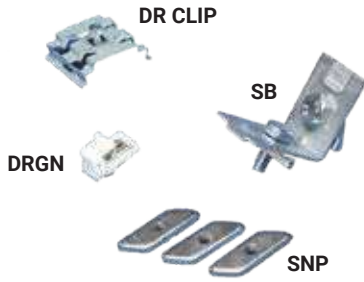

DR CLIP

CLIP-NUTS FOR SYMMETRIC DIN RAILS

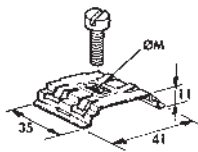

Article No.	Description	Ø M	Box	kg
563100	DR CLIP M4	M4	10	0.01
563110	DR CLIP M6	M6	10	0.01

DRGN

CLIP-NUTS FOR ASYMMETRIC DIN RAILS

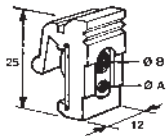

Article No.	Description	Ø A	Ø B	Box	kg
558070	DRGN M5	M3	M5	100	0.038
558080	DRGN M6	M4	M6	100	0.038

SNP

STRUTAL NUTS

• Zinc plated steel

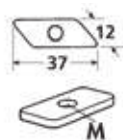

Article No.	Description	M	Box	kg
560500	SNP-M4	M4	100	0.02
560510	SNP-M5	M5	100	0.02
560520	SNP-M6	M6	100	0.02
560530	SNP-M8	M8	100	0.02

SB

STEEL ANGLE BRACKET

- With pre-assembled M8 nut
- Thickness 2 mm (zinc plated steel)

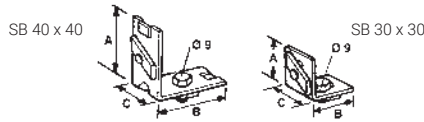

Article No.	Description	A mm	B mm	C mm	Box	kg
557770	SB 30 x 30	30	30	28	25	0.06
557720	SB 40 x 40	40	40	28	25	0.07

IRS

ANGLE SUPPORT BRACKET

• Zinc plated steel

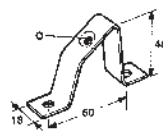

Article No.	Description	Ø M	Box	kg
557970	IRS 5	5	50	0.038
557980	IRS 6	6	50	0.038

MDRCPT-2

MANUAL DIN RAIL CUTTING AND PUNCHING TOOL

- Punches slots and cuts DIN rail without burrs or deformation
- Punches horizontal and vertical slots
- Works with five different types of DIN rail and M6 threaded rod
- Includes ruler, guide and end stops
- RoHS compliant

Overall Dimensions

Length: 100 mm - Depth : 165 mm

Height: 200 mm - Slot Size : 6.5 x 9.5 mm

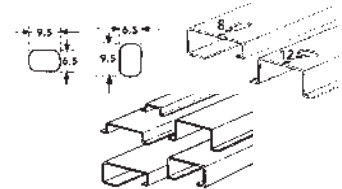

Article No.	Description	Box	kg
559142	MDRCPT-2	1	13

Cross Reference List

Article Number	Page	Article Number	Page	Article Number	Page
549000	6	550950	7	557800	35
549010	6	550970	7	557810	35
549020	6	550980	7	557850	35
549030	6	550180	6	557855	35
549200	6	550190	6	557860	35
549210	6	550200	6	557900	35
549220	6	550210	6	557910	35
549230	6	550220	6	557950	35
550160	6	550230	6	557960	35
549600	7	550250	6	558000	35
549610	7	550290	6	558010	35
549620	7	553020	8	558050	35
549630	7	553030	8	558060	35
549640	7	553040	8	558310	9
549700	7	553050	8	558340	9
549710	7	553060	8	558370	9
549720	7	553070	8	558410	9
549730	7	553400	9	558440	9
549740	7	553405	9	558460	9
549750	7	553410	9	558480	9
549760	7	553430	9	558490	9
550350	7	553440	9	504971	22
550360	7	553505	9	504980	22
550370	7	553510	9	504991	22
550380	7	553520	9	542030	32
550390	7	553530	9	542050	32
550400	7	553540	9	542070	32
550410	7	553080	9	542080	32
550420	7	553090	9	542110	32
550430	7	557500	35	542120	32
550440	7	557520	35	548400	31
550450	7	557700	35	548410	31
550600	7	557750	35	548420	31
550610	7	557780	35	548430	31
550620	7	557790	35	548440	31
550630	7	557720	36	548450	31
550640	7	557770	36	548451	31
550650	7	557970	36	548470	31
550660	7	557980	36	548480	31
550670	7	558070	36	548490	31
550770	7	558080	36	548500	31
550780	7	559142	36	548510	31
550790	7	560500	36	548511	31
550900	7	560510	36	548520	31
550910	7	560520	36	548530	31
550920	7	560530	36	548540	31
550930	7	563100	36	548550	31
550940	7	563110	36	548560	31

Cross Reference List

Article Number	Page	Article Number	Page	Article Number	Page
548570	31	551280	30	556640	13
548580	31	551330	30	556740	13
548581	31	551350	21	556910	13
548590	31	552050	23	559580	33
548600	31	552070	23	559590	33
548601	31	552200	31	560600	30
548602	31	552220	31	560610	30
548609	31	553151	11	560620	30
548610	31	553152	11	560630	30
548620	31	553153	11	560640	30
548629	31	553450	13	560650	30
548630	31	553460	13	560660	30
548640	31	553470	13	560670	30
548650	31	553480	13	560700	30
548660	31	553490	13	560710	30
548670	31	554000	34	560720	30
548680	31	554010	34	560730	30
548690	31	554020	34	560740	30
548700	31	554030	34	560750	30
549260	25	554040	34	560800	30
549270	25	554050	34	560810	30
549300	25	554060	34	560820	30
549310	25	554070	34	560830	30
549320	25	554080	34	560840	30
549340	25	554430	33	560850	30
549350	25	554450	33	560860	29
549360	25	554460	33	560870	29
549370	25	554470	33	560880	29
549380	25	554490	33	560890	29
549390	25	554510	33	560900	29
549400	25	554530	33	560910	29
549410	25	554550	33	560920	29
549420	25	554880	34	560930	29
549430	25	554890	34	560940	29
549450	25	554900	34	560950	29
549470	25	554910	34	560960	29
549480	25	556000	33	561500	27
551000	27	556010	33	561520	28
551010	27	556020	33	561540	28
551020	27	556030	33	561560	30
551060	27	556100	33	561570	30
551070	28	556110	33	561580	30
551080	28	556200	34	561590	30
551090	28	556210	34	561600	30
551151	23	556220	34	561610	30
551181	23	556230	34	561620	30
551190	21	556240	34	561630	30
551260	30	556250	34	561640	30

Cross Reference List

Article Number	Page	Article Number	Page
561660	30	568670	15
561670	30	568671	15
561680	30	568672	15
561690	30	568673	16
561700	30	568674	16
561710	30	568675	16
561720	30	568676	16
561730	30	568677	16
561740	30	568678	17
561750	30	568679	17
561760	30	568680	17
561770	30	568710	19
561780	30	568711	19
561790	30	568712	19
561800	30	568713	19
561810	30	568714	19
561820	30	568715	19
561830	30	568716	20
561840	30	568717	20
561850	30	568718	20
561870	28	568719	20
561880	28	568720	20
562100	13	568721	20
562700	21	568722	20
562710	21	561210	9
562750	21	561220	9
562760	21	567880	9
562800	21	568700	8
562810	21	568730	8
562830	21	553100	8
562840	21	553110	8
563120	30	553120	8
563410	13	553200	8
568610	13	553210	8
568611	13	553220	8
568612	18	553230	8
568613	18	553250	8
568614	18	553260	8
568620	13		
568630	13		
568660	12		
568661	12		
568662	12		
568665	12		
568666	12		
568667	15		
568668	15		
568669	15		

OTHER LITERATURE

DISTRIBUTION BLOCKS, POWER BLOCKS AND DISTRIBUTION TERMINAL



HYDRAULIC & MANUAL TOOLS

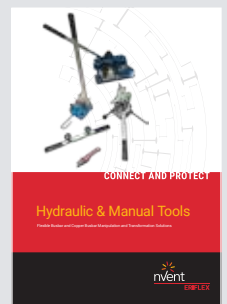

FLEXIBLE CONDUCTORS



READY-TO-USE POWER CONDUCTOR: IBS & IBSB ADVANCED TECHNICAL GUIDE



NVENT ERIFLEX FLEXIBAR TECHNICAL HANDBOOK

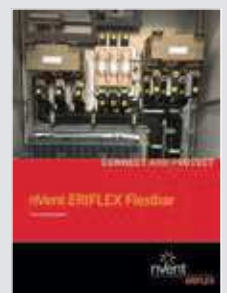

Our powerful portfolio of brands:

CADDY ERICO HOFFMAN RAYCHEM SCHROFF TRACER



[nVent.com/ERIFLEX](https://www.nVent.com/ERIFLEX)