



CONNECT AND PROTECT

Répartiteurs, blocs de
jonction, bornes

nvent

ERIFLEX

Sommaire

nVent ERIFLEX Advanced Technology	3-4
Répartiteurs unipolaires (séries UD)	5-16
Répartiteurs bipolaire et tétrapolaires (séries TD & BD)	17-22
Blocs de jonction (séries SB)	23-38
Bornes (séries SBTT, SBLL & SBLT)	39-45
Répartiteurs et Supports Tétrapolaires Etagés (séries TR & BS)	46-47
Système déconnectable PEN	48-49
Répartiteurs et accessoires	50
Rails DIN	51-52
Index	53-55

nVent ERIFLEX Advanced Technology

RÉPARTITEURS, BLOCS DE JONCTION, BORNES

INTRODUCTION À LA HAUTE TECHNOLOGIE (ADVANCED TECHNOLOGY) :

L'isolant haute technologie est un thermoplastique haute résistance, ignifugé sans halogène ; à faible émission de fumées.

Le produit ne génère pas de gaz corrosifs et produit des fumées de faible opacité relative, en conformité avec les normes CEI 61034-2 et UL 2885. La faible émission de fumées optimise les conditions de visibilité et permet aux personnes de localiser plus facilement les issues de secours, ainsi qu'aux équipes de sauvetage d'évaluer plus précisément une situation d'urgence pour une meilleure intervention. Les blocs de jonction et les répartiteurs sont synonymes d'une plus grande sécurité pour les individus, de moins de dommages pour les équipements électriques et d'un impact environnemental réduit.

L'absence d'halogène permet de réduire la quantité de fumées toxiques. Conformément aux normes CEI 60754-1 et UL 2885, le bloc ne contient pas d'halogène, ce qui minimise sa toxicité et en fait un produit idéal pour les applications en espace confiné, les applications ferroviaires et autres espaces publics tels que les hôpitaux et les écoles. Cela facilite également l'utilisation des blocs de jonction et des répartiteurs dans les applications spécifiques telles que les milieux sous-marins, les appareillages de commutation et les autres environnements confinés qui nécessitent une solution à faibles émissions.

En plus des caractéristiques ci-dessus, les blocs de jonction et les répartiteurs sont également conformes aux normes UL 94-V0 et d'essai au fil incandescent à 960°C. La partie « ignifuge » de l'essai démontre la caractéristique d'autoextinguibilité. Cette caractéristique supérieure du bloc est également illustrée par un indice critique d'oxygène de 30 %. En cas d'incendie, le bloc génère une quantité limitée de fumées, ce qui est moins dommageable pour votre matériel électrique.

<https://go.nvent.com/nvent-eriflex-advance-technology>

Les blocs nVent ERIFLEX à faible émission de fumées :



- Optimise les conditions de visibilité grâce à de faibles émissions de fumée
- Permet aux personnes de localiser plus facilement les issues de secours
- Permet aux équipes de sauvetage d'évaluer plus précisément une situation d'urgence pour une meilleure intervention
- Limite les dommages pour les équipements électriques



Les blocs nVent ERIFLEX sans halogène :



Notre nouvelle technologie contient des matériaux sans halogène et offrent une meilleure protection pour la sécurité du personnel et pour vos installations électriques réduisant la corrosion due à la fumée.

Du matériel sans halogène signifie qu'il ne contient pas :

- Fluor
- Chlore
- Brome
- Iode
- Astatine

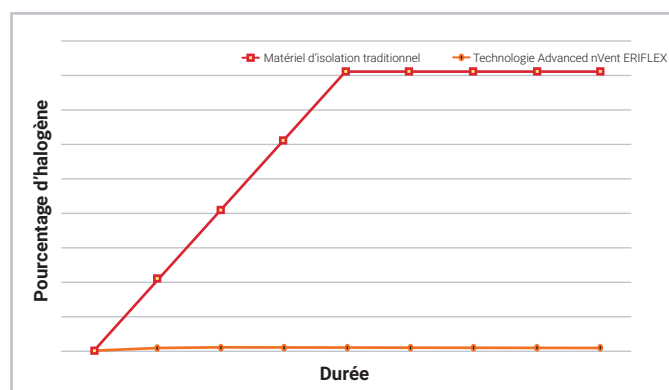

nVent ERIFLEX Advanced Technology

RÉPARTITEURS, BLOCS DE JONCTION, BORNES

Les blocs nVent ERIFLEX ignifugés :



Le matériel ignifugé, aussi appelé matériel autoextinguible, a pour effet de diminuer la propagation du feu et est en accord avec les normes internationales suivantes :

- UL 94-V0
- IEC 60695-2-11 (Test au fil incandescent)

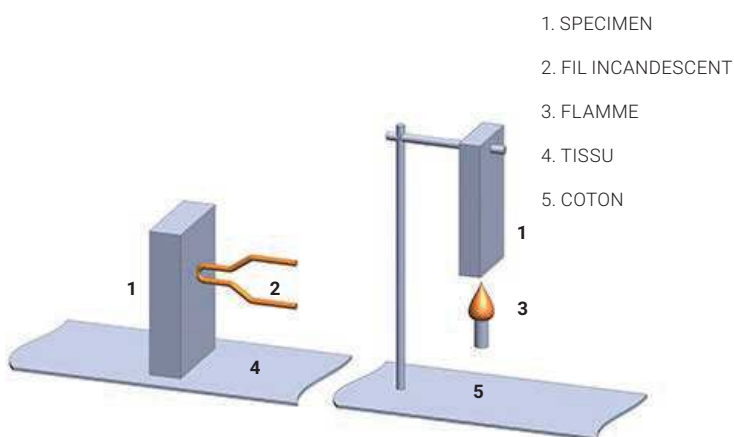

Avec la caractéristique ignifugé, la technologie Advanced est conforme à l'UL 94-V0 et à l'IEC 60695-2-11 Test au fil incandescent 960°. La portion de test ignifugé illustre la caractéristique d'autoextinguibilité et réduit le risque de propagation du feu, et réduit ainsi les dommages causés à vos installations électriques.



Répartiteurs unipolaires

CARACTÉRISTIQUES PRINCIPALES

Une solution compact

Connexion côté ligne avec un câble, deux câbles ou un conducteur plat (nVent ERIFLEX Flexibar ou tresses de puissance prête à l'utilisation IBS/IBSB Advanced)

Système breveté de maintien des vis de fixation, écran de protection bleu transparent

Protection IP20

Écran de protection transparent amovible sur charnière

Fill Ratio > 95% pour une connexion optimale avec ou sans ferrule

Les blocs en cuivre étamé ou en aluminium étamé permettent de connecter des conducteurs en cuivre et en aluminium pour une connexion directe ou en utilisant un embout

Blocs modulaires à assembler pour la construction de blocs de puissance multipolaires

Le suffixe AL sur les numéros d'articles désigne les blocs en Aluminium étamé

Fixation facile sur profil DIN ou sur platine

Système breveté. Permet une inspection visuelle du câblage et la vérification des connexions







Le clapet IP 20 : permet d'utiliser les conducteurs plats de tailles différentes pour un contact mécanique et électrique optimal.

- UL 1059 Recognized ou UL 1953 Listed en fonction du model
- CSA C22.2 NO. 158 en fonction du model
- Testé et certifié suivant IEC 60947-7-1
- Valeur de court-circuit jusqu'à 100 KA (voir dossier UL N° E 198301)
- $U_i = 1000V$ AC/DC IEC minimum 600 V UL ou 1000V UL en fonction du model
- Sans Halogène
- Indice d'inflammabilité : UL 94V-0
- Conforme RoHS



Répartiteurs unipolaires – guide de sélection rapide

GUIDE DE SÉLECTION RAPIDE – RÉPARTITEURS UNIPOLAIRES (TYPE UD)

Référence	N° Article	Intensité max. IEC	Intensité max. UL	Côté ligne : Nbre de connexion	Côté ligne Min et Max taille du conducteur	Côté charge : Nbre de connexion	Côté charge Min et Max taille du conducteur	Max voltage IEC	Max voltage UL
UD-80A	569010	80 A	85 A	 1 Câble	6–16 mm ² #16–# 4 AWG	 6 Câbles	2.5–16 mm ² #16–# 4 AWG	1,000 VAC/DC	600 VAC/DC
UDJ-125A	569020	125 A	150 A	 1 Câble	10–35 mm ² #8–1/0 AWG	 7 Câbles	2.5–16 mm ² #14–# 4 AWG	1,000 VAC/DC	600 VAC/DC
UDJ-160A	569030	160 A	200 A	 1 Câble	10–70 mm ² #8–3/0 AWG	 7 Câbles	2.5–16 mm ² #14–# 4 AWG	1,000 VAC/DC	600 VAC/DC
UD-250A	569040	250 A	255 A	 1 Câble	35–120 mm ² #6 AWG–250 kcmil	 11 Câbles	2.5–35 mm ² #14–# 1 AWG	1,000 VAC/DC	600 VAC/DC
UDF-250A	569041	250 A	255 A	 Conducteur plat	Flexibar 3X9X0.8–6x15.5x0.8	 6 Câbles	2.5–16 mm ² #14–# 4 AWG	1,000 VAC/DC	600 VAC/DC
UD-400112AL	569252	400 A	335 A	 1 Câble	95–185 mm ² 3/0 AWG–400 kcmil	 12 Câbles	2.5–10 mm ² # 14–# 6 AWG	1,000 VAC, 1,500 VDC	1,000 VAC/DC
UD-400112CU	569052	400 A	335 A	 1 Câble	96–185 mm ² 3/0 AWG–400 kcmil	 12 Câbles	2.5–10 mm ² # 14–# 6 AWG	1,000 VAC, 1,500 VDC	1,000 VAC/DC
UD-400212AL	569251	400 A	400 A	 2 Câbles	35–95 mm ² #8–3/0 AWG	 12 Câbles	2.5–10 mm ² # 14–# 6 AWG	1,000 VAC, 1,500 VDC	1,000 VAC/DC
UD-400212CU	569051	400 A	400 A	 2 Câbles	35–95 mm ² #8–3/0 AWG	 12 Câbles	2.5–10 mm ² # 14–# 6 AWG	1,000 VAC, 1,500 VDC	1,000 VAC/DC
UD-400A	569050	400 A	335 A	 1 Câble	95–185 mm ² 3/0 AWG–400 kcmil	 11 Câbles	2.5–35 mm ² #14–# 1 AWG	1,000 VAC/DC	600 VAC/DC
UDF-500A	569060	500 A	335 A	 Conducteur plat	Flex. 4x15.5x0.8–8x24x1	 11 Câbles	2.5–35 mm ² #14–# 1 AWG	1,000 VAC/DC	600 VAC/DC
UD6C500AL	569201	500 A	380 A	 1 Câble	95–240 mm ² 3/0AWG- 500 kcmil	 6 Câbles	10–50 mm ² #8–1/0 AWG	1,000 VAC, 1,500 VDC	1,000 VAC/DC
UDF6C500AL	569202	500 A	475 A	 Conducteur plat	Flex. 2x20x1–10x24x1 IBS/IBSB 50–100 mm ²	 6 Câbles	10–50 mm ² #8–1/0 AWG	1,000 VAC, 1,500 VDC	1,000 VAC/DC
UDF9C500AL	569204	500 A	490 A	 Conducteur plat	Flex. 2x20x1–10x24x1 IBS/IBSB 50–100 mm ²	 9 Câbles	4–25 mm ² #12–# 4 AWG	1,000 VAC, 1,500 VDC	1,000 VAC/DC
UDF12C500AL	569206	500 A	500 A	 Conducteur plat	Flex. 2x20x1–10x24x1 IBS/IBSB 50–100 mm ²	 12 Câbles	4–25 mm ² #12–# 4 AWG	1,000 VAC, 1,500 VDC	1,000 VAC/DC
UD9C630AL	569203	630 A	420 A	 1 Câble	120–300 mm ² 4/0 AWG- 600 kcmil	 9 Câbles	4–25 mm ² #12–# 4 AWG	1,000 VAC, 1,500 VDC	1,000 VAC/DC
UD2C12C630AL	569205	630 A	670 A	 2 Câbles	95–185 mm ² 3/0 AWG–400 kcmil	 12 Câbles	4–25 mm ² #12–# 4 AWG	1,000 VAC, 1,500 VDC	1,000 VAC/DC
UDF12C800AL	569208	800 A	670 A	 Conducteur plat	Flex. 2x20x1–10x32x1 IBS/IBSB 50–240 mm ²	 12 Câbles	4–25 mm ² #12–# 4 AWG	1,000 VAC, 1,500 VDC	1,000 VAC/DC
UD2C12C1000AL	569207	1000 A	760 A	 2 Câbles	35–240 mm ² 2 AWG–500 kcmil	 12 Câbles	4–25 mm ² #12–# 4 AWG	1,000 VAC, 1,500 VDC	1,000 VAC/DC
UDF9C1000AL	569210	1000 A	840 A	 Conducteur plat	Flex. 6x24x1–10x50x1 IBS/IBSB 120–240 mm ²	 9 Câbles	10–95 mm ² #8–3/0 AWG	1,000 VAC, 1,500 VDC	1,000 VAC/DC
UD2C9C1250AL	569209	1250 A	950 A	 2 Câbles	185–400 mm ² 400 kcmil–750 kcmil	 9 Câbles	10–95 mm ² #8–3/0 AWG	1,000 VAC, 1,500 VDC	1,000 VAC/DC

Répartiteurs unipolaires



UD 80 A



UDJ 125 A



UDJ 160 A

UD-80 A
80 A – IEC
85 A –

1 câble – 6 câbles

- Modulaire: Avec une seule arrivée, les répartiteurs peuvent être alimentés en parallèle en utilisant un pont isolé.
- Facilité du doublage du Neutre.

- Icw kA rms 1s: 3
- Ipk kA: 22
- Ui: 1000 VAC/DC IEC
- Vin: 600 VAC/DC UL

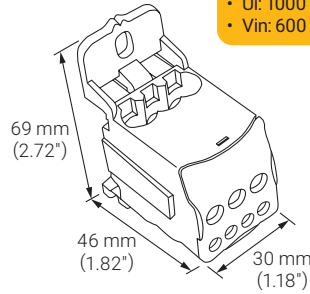

UDJ-125 A
125 A – IEC
150 A –

1 câble – 7 câbles

- Modulaire: Avec une seule arrivée, les répartiteurs peuvent être alimentés en parallèle en utilisant un pont isolé (FSJ). Facilité du doublage du Neutre.

- Icw kA rms 1s: 4.2
- Ipk kA: 30
- Ui: 1000 VAC/DC IEC
- Vin: 600 VAC/DC UL

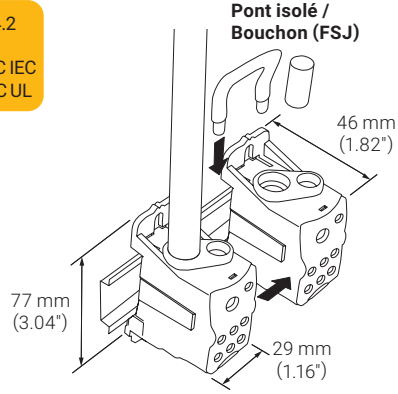

UDJ-160 A
160 A – IEC
200 A –

1 câble – 7 câbles

- Icw kA rms 1s: 11.8
- Ipk kA: 30
- Ui: 1000 VAC/DC IEC
- Vin: 600 VAC/DC UL

Métrique				
	Nbre de sorties	Conducteurs	Section mm ²	Ø mm
	x1		6-16	6.8
	x6		2.5-6 (x4) 2.5-16 (x2)	4.5 6.8

Impérial				
	Nbre de sorties	Conducteurs	Section AWG	Ø in
	x1		#16-#4	0.27
	x6		#16-#8 (x4) #16-#4 (x2)	0.177 0.27

- Câble souple avec embout
- Câble rigide

N° Article	Désignation		kg/lbs
569010	UD-80A	1	0.07 / 0.15

Métrique				
	Nbre de sorties	Conducteurs	Section mm ²	Ø mm
	x1		10-35	10
	x7		6-16 (x1) 2.5-16 (x4-embout)/(x6-embout)	6.8 6.8

Impérial				
	Nbre de sorties	Conducteurs	Section AWG	Ø in
	x1		#8-1/0	0.394
	x7		#14-#2 (x1) #14-#4 (x6-embout)	0.27 0.27

- Câble souple avec embout
- Câble rigide

N° Article	Désignation		kg/lbs
569020	UDJ-125 A	1	0.15/0.33
569150	FSJ*	25	0.03/0.07

* Pas de certification UL®

Métrique				
	Nbre de sorties	Conducteurs	Section mm ²	Ø mm
	x1		10-70	12.3
	x7		6-16 (x1) 2.5-16 (x4-embout)/(x6-embout)	6.8 6.8

Impérial				
	Nbre de sorties	Conducteurs	Section AWG	Ø in
	x1		#8-3/0	0.484
	x7		#14-#2 (x1) #14-#4 (x6-embout)	0.27 0.27

- Câble souple avec embout
- Câble rigide

N° Article	Désignation		kg/lbs
569030	UDJ-160 A	1	0.15/0.33
569150	FSJ*	25	0.03/0.07

* Pas de certification UL®

Répartiteurs unipolaires



UD-250A
250 A – IEC
255 A – cULus

1 câble – 11 câbles

- Icw kA rms 1s: 24.5
- Ipk kA: 51
- Ui: 1000 VAC/DC IEC
- Vin: 600 VAC/DC UL

UDF-250A
250 A – IEC
255 A – cULus

Conducteur plat – 6 câbles

- Icw kA rms 1s: 23.0
- Ipk kA: 23
- Ui: 1000 VAC/DC IEC
- Vin: 600 VAC/DC UL

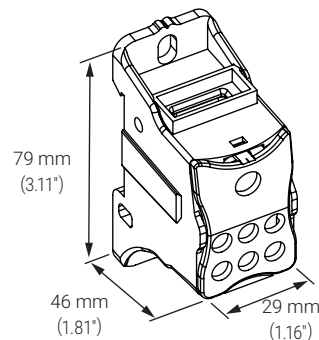
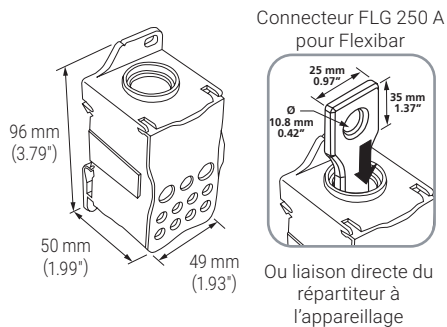

Métrique				
	Nbre de sorties	Conducteurs	Section mm ²	Ø mm
	x1		35-120	15
	x11		6-25 (x2) / 6-35 (x2) 2.5-16 (x5) 2.5-10 (x4)	9 6.8 6.1

Métrique				
	Nbre de sorties	Conducteurs	Section mm ²	Ø mm
	x1	Flexibar Advanced	3x9x0.8-6x15.5x0.8	N/A
	x6		2.5-16 (x6)	6.8

Impérial				
	Nbre de sorties	Conducteurs	Section AWG	Ø in
	x1		#6-250 kcmil	0.59
	x11		#10-#1 (x2) #14-#4 (x5) #14-#6 (x4)	0.354 0.27 0.24

Impérial				
	Nbre de sorties	Conducteurs	Section AWG	Ø in
	x1	Flexibar Advanced	3x9x0.8-6x15.5x0.8	N/A
	x6		#14-#4 (x6)	0.27

Câble souple avec embout

Câble rigide

Câble souple avec embout

Câble rigide

N° Article	Désignation		kg/lbs
569040	UD-250A	1	0.42/0.89
569160	FLG250*	10	0.05/0.12

N° Article	Désignation		kg/lbs
569041	UDF-250A	1	0.15 / 0.33

* Pas de certification UL® et hors IP20

Répartiteurs unipolaires



UD 400 A

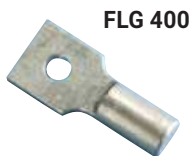

FLG 400

Pour raccordement des nVent ERIFLEX Flexibar Advanced



UDF 500A

UD-400 A
400 A – IEC
335 A – cRU^{US} SB[®]
1 câble – 11 câbles

- Icw kA rms 1s: 24.5
- Ipk kA: 51
- Ui: 1000 VAC/DC IEC
- Vin: 600 VAC/DC UL

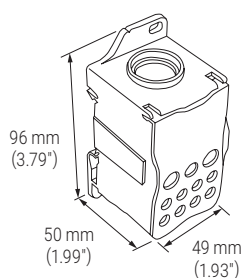

Connecteur FLG 400 A pour Flexibar

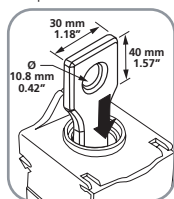

Ou liaison directe du répartiteur à l'appareillage

UDF-500A
500 A – IEC
335 A – cRU^{US}
Conducteur plat – 11 câbles

- Icw kA rms 1s: 24.5
- Ipk kA: 51
- Ui: 1000 VAC/DC IEC
- Vin: 600 VAC/DC UL

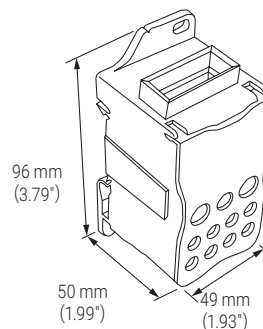

Métrique				
	Nbre de sorties	Conducteurs	Section mm ²	Ø mm
	x1		95–185	19
	x11		6–25 (x2) / 6–35 (x2)	9
			2.5–16 (x5)	6.8
			2.5–10 (x4)	6.1

Métrique				
	Nbre de sorties	Conducteurs	Section mm ²	Ø mm
	x1	Flexibar Advanced	4x15.5x0.8–8x24x1	N/A
	x11		2.5–16 (x5)	6.8
			2.5–10 (x4)	6.1
			6–25 (x2)	9

Impérial				
	Nbre de sorties	Conducteurs	Section AWG	Ø in
	x1		3/0–400 kcmil	0.748
	x11		#10–#1 (x2)	0.354
			#14–#4 (x5)	0.27
			#14–#6 (x4)	0.24

Impérial				
	Nbre de sorties	Conducteurs	Section AWG	Ø in
	x1	Flexibar Advanced	4x15.5x0.8–8x24x1	N/A
	x11		#14–#4 (x5)	0.27
			#14–#6 (x4)	0.24
			#10–#1 (x2)	0.354

Câble souple avec embout

Câble rigide

Câble souple avec embout

Câble rigide

N° Article	Désignation		kg/lbs
569050	UD-400A	1	0.4/0.89
569170	FLG400*	10	0.05 / 0.12

N° Article	Désignation		kg/lbs
569060	UDF-500A	1	0.37 / 0.82

* Pas de certification UL[®] et hors IP20

Répartiteurs unipolaires

DÉDIÉS AUX APPLICATIONS SOLAIRES

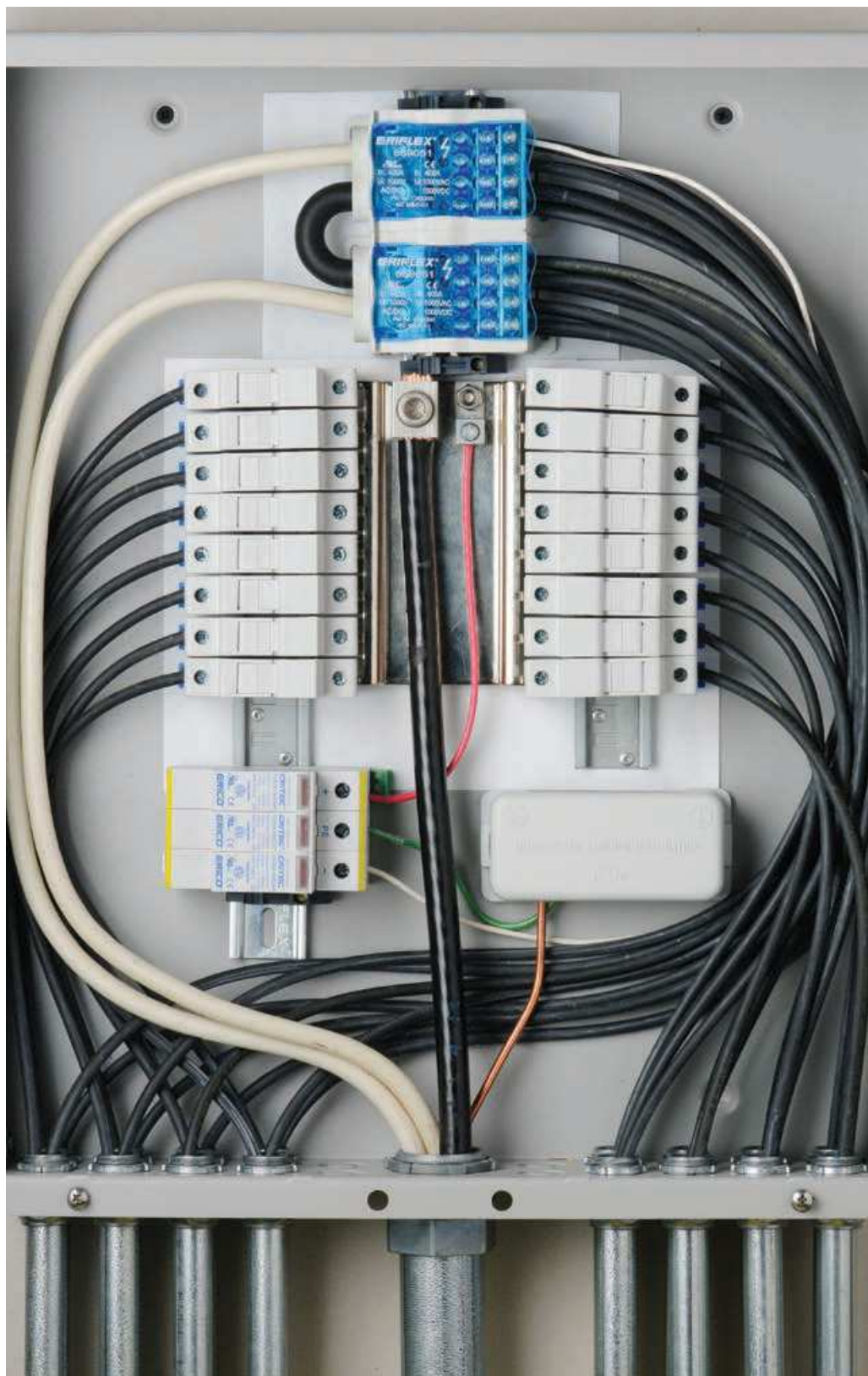

Certification UL® 1000 V AC/DC et IEC® 1000 V AC / 1500V DC –
conforme aux applications solaire photovoltaïque

Répartiteurs unipolaires

DÉDIÉS AUX APPLICATIONS SOLAIRES



UD-400212AL & UD-400212CU
400 A – IEC
400 A – cULus
2 câbles – 12 câbles

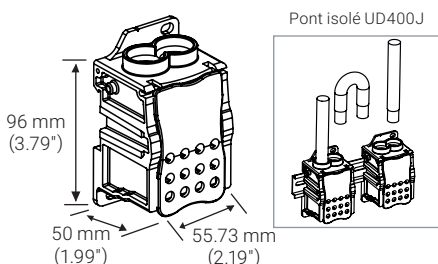

- Icw kA rms 1s: 24.5
- Ipk kA: 51
- Ui: 1000 VAC IEC
- Ui: 1500 VDC IEC
- Vin: 1000 VAC/DC UL



UD-400112AL & UD-400112CU
400 A – IEC
335 A – cULus
1 câble – 12 câbles

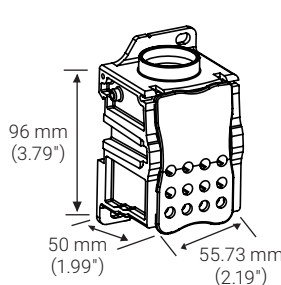

- Icw kA rms 1s: 24.5
- Ipk kA: 51
- Ui: 1000 VAC IEC
- Ui: 1500 VDC IEC
- Vin: 1000 VAC/DC UL

Métrique				
	Nbre de sorties	Conducteurs	Section mm ²	Ø mm
	x2		35–95	13.5
	x12		2.5–10	6.1

Impérial				
	Nbre de sorties	Conducteurs	Section AWG	Ø in
	x2		#8–3/0	0.53
	x12		#14–#6	0.24

- Câble souple avec embout
- Câble rigide

N° Article	Désignation		kg/lbs
569251	UD-400212AL Aluminium étamé	1	0.160 / 0.35
569051	UD-400212CU Cuivre étamé	1	0.38 / 0.84
569200	UD400J (380 A Max)	10	0.06 / 0.13

Métrique				
	Nbre de sorties	Conducteurs	Section mm ²	Ø mm
	x1		95–185	19
	x12		2.5–10	6.1

Impérial				
	Nbre de sorties	Conducteurs	Section AWG	Ø in
	x1		3/0–400 kcmil	0.787
	x12		#14–#6	0.24

- Câble souple avec embout
- Câble rigide

N° Article	Désignation		kg/lbs
569252	UD-400112AL Aluminium étamé	1	0.180 / 0.4
569052	UD-400112CU Cuivre étamé	1	0.4 / 0.88

Répartiteurs unipolaires

UD6C500AL



UDF6C500AL



UD6C500AL
715 A – IEC
380 A –

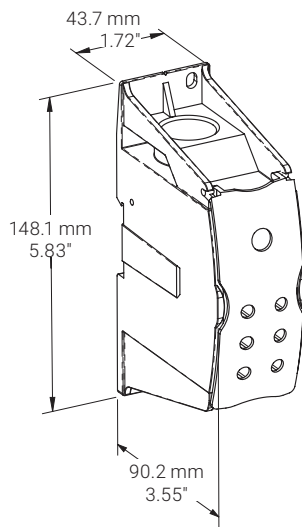

1 câble – 6 câbles

- Icw kA rms 1s : 34.3
- Ipk kA : 52.5
- Ui: 1000 VAC IEC
- Ui: 1500 VDC IEC
- Vin: 1000 VAC/DC UL

UDF6C500AL
775 A – IEC
(Flexibar Advanced)
545 A – IEC
(IBSB Advanced)
475 A –

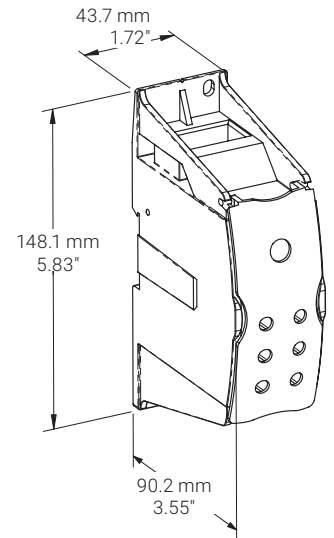

Conducteur plat – 6 câbles

- Icw kA rms 1s : 34.3
- Ipk kA : 52.5
- Ui: 1000 VAC IEC
- Ui: 1500 VDC IEC
- Vin: 1000 VAC/DC UL

Métrique				
	Nbre de sorties	Conducteurs	Section mm ²	Ø mm
	x1		95–240	22
	x6		10–50	10

Impérial				
	Nbre de sorties	Conducteurs	Section AWG	Ø in
	x1		3/0–500 kcmil	0.866
	x6		8–1/0	0.394

- Câble souple avec embout
- Câble rigide

N° Article	Désignation		kg/lbs
569201	UD6C500AL	1	0.34 / 0.75

Métrique				
	Nbre de sorties	Conducteurs	Section mm ²	Ø mm
	x1	Flexibar Advanced IBSB Advanced	2x20x1–10x24x1 50–100	N/A
	x6		10–50	10

Impérial				
	Nbre de sorties	Conducteurs	Section AWG	Ø in
	x1	Flexibar Advanced IBSB Advanced	2x20x1–10x24x1 50–100	N/A
	x6		8–1/0	0.394

- Câble souple avec embout
- Câble rigide

N° Article	Désignation		kg/lbs
569202	UDF6C500AL	1	0.34 / 0.75

Répartiteurs unipolaires



UDF9C500AL



UDF12C500AL

UDF9C500AL
 710 A – IEC (Flexibar Advanced)
 510 A – IEC (IBSB Advanced)
 490 A –

Conducteur plat – 9 câbles

- Icw kA rms 1s: 32.2
- Ipk kA: 52.5
- Ui: 1000 VAC IEC
- Ui: 1500 VDC IEC
- Vin: 1000 VAC/DC UL

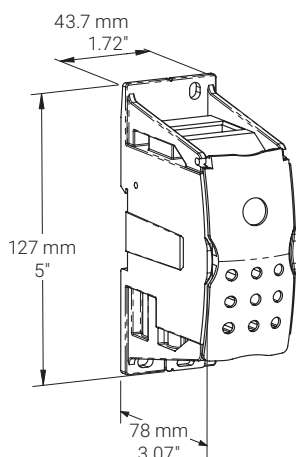

UDF12C500AL
 780 A – IEC (Flexibar Advanced)
 550 A – IEC (IBSB Advanced)
 500 A –

Conducteur plat – 12 câbles

- Icw kA rms 1s: 34.3
- Ipk kA: 52.5
- Ui: 1000 VAC IEC
- Ui: 1500 VDC IEC
- Vin: 1000 VAC/DC UL

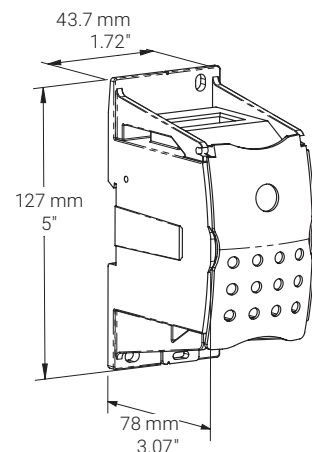

Métrique				
	Nbre de sorties	Conducteurs	Section mm ²	Ø mm
	x1	Flexibar Advanced IBSB Advanced	2x20x1-10x24x1 50-100	N/A
	x9	 	4-25	6.9

Impérial				
	Nbre de sorties	Conducteurs	Section AWG	Ø in
	x1	Flexibar Advanced IBSB Advanced	2x20x1-10x24x1 50-100	N/A
	x9		12-4	0.272

- Câble souple avec embout
- Câble rigide

N° Article	Désignation		kg/lbs
569204	UDF9C500AL	1	0.27 / 0.6

Métrique				
	Nbre de sorties	Conducteurs	Section mm ²	Ø mm
	x1	Flexibar Advanced IBSB Advanced	2x20x1-10x24x1 50-100	N/A
	x12	 	4-25	6.9

Impérial				
	Nbre de sorties	Conducteurs	Section AWG	Ø in
	x1	Flexibar Advanced IBSB Advanced	2x20x1-10x24x1 50-100	N/A
	x12		12-4	0.272

- Câble souple avec embout
- Câble rigide

N° Article	Désignation		kg/lbs
569206	UDF12C500AL	1	0.36 / 0.8

Répartiteurs unipolaires

UD9C630AL



UD2C12C630AL



UD9C630AL
705 A – IEC
420 A –

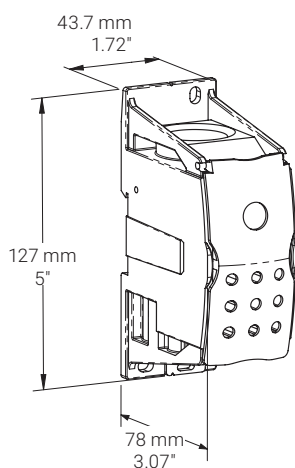

1 câble – 9 câbles

- Icw kA rms 1s: 32.2
- Ipk kA: 52.5
- Ui: 1000 VAC IEC
- Ui: 1500 VDC IEC
- Vin: 1000 VAC/DC UL

UD2C12C630AL
1010 A – IEC
670 A –

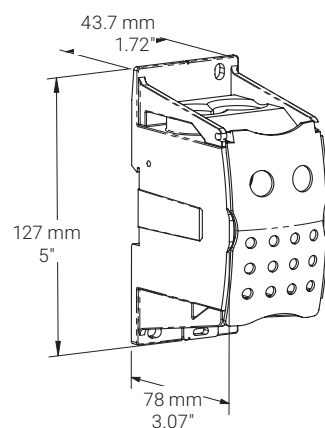

2 câbles – 12 câbles

- Icw kA rms 1s: 42.9
- Ipk kA: 52.5
- Ui: 1000 VAC IEC
- Ui: 1500 VDC IEC
- Vin: 1000 VAC/DC UL

Métrique				
	Nbre de sorties	Conducteurs	Section mm ²	Ø mm
	x1		120–300	23.4
	x9		4–25	6.9

Impérial				
	Nbre de sorties	Conducteurs	Section AWG	Ø in
	x1		4/0–600 kcmil	0.92
	x9		12–4	0.272

- Câble souple avec embout
- Câble rigide

N° Article	Désignation		kg/lbs
569203	UD9C630AL	1	0.27 / 0.6

Métrique				
	Nbre de sorties	Conducteurs	Section mm ²	Ø mm
	x2		95–185	19.1
	x12		4–25	6.9

Impérial				
	Nbre de sorties	Conducteurs	Section AWG	Ø in
	x2		3/0–400 kcmil	0.75
	x12		12–4	0.272

- Câble souple avec embout
- Câble rigide

N° Article	Désignation		kg/lbs
569205	UD2C12C630AL	1	0.34 / 0.75

Répartiteurs unipolaires

UDF12C800AL



UD2C12C1000AL



UDF12C800AL
885 A – IEC
(Flexibar Advanced)
800 A – IEC
(IBSB Advanced)
670 A –

Conducteur plat – 12 câbles

- Icw kA rms 1s: 42.9
- Ipk kA: 73.5
- Ui: 1000 VAC IEC
- Ui: 1500 VDC IEC
- Vin: 1000 VAC/DC UL

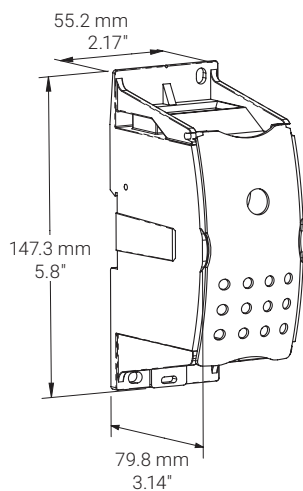

UD2C12C1000AL
1070 A – IEC
760 A –

2 câbles – 12 câbles

- Icw kA rms 1s: 42.9
- Ipk kA: 73.5
- Ui: 1000 VAC IEC
- Ui: 1500 VDC IEC
- Vin: 1000 VAC/DC UL

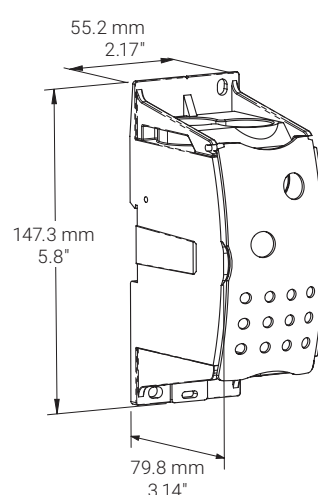

Métrique				
	Nbre de sorties	Conducteurs	Section mm ²	Ø mm
	x1	Flexibar Advanced IBSB Advanced	2x20x1-10x32x1 50-240	N/A
	x12		4-25	6.9

Impérial				
	Nbre de sorties	Conducteurs	Section AWG	Ø in
	x1	Flexibar Advanced IBSB Advanced	2x20x1-10x32x1 50-240	N/A
	x12		12-4	0.272

- Câble souple avec embout
- Câble rigide

N° Article	Désignation		kg/lbs
569208	UDF12C800AL	1	0.45 / 1

Métrique				
	Nbre de sorties	Conducteurs	Section mm ²	Ø mm
	x2		35-240	22
	x12		4-25	6.9

Impérial				
	Nbre de sorties	Conducteurs	Section AWG	Ø in
	x2		2-500 kcmil	0.87
	x12		12-4	0.272

- Câble souple avec embout
- Câble rigide

N° Article	Désignation		kg/lbs
569207	UD2C12C1000AL	1	0.45 / 1

Répartiteurs unipolaires

UDF9C1000AL



UD2C9C1250AL



UDF9C1000AL
1450 A – IEC
(Flexibar Advanced)
1100 A – IEC
(IBSB Advanced)
840 A – 

Conducteur plat – 9 câbles

- Icw kA rms 1s: 71.5
- Ipk kA: 73.5
- Ui: 1000 VAC IEC
- Ui: 1500 VDC IEC
- Vin: 1000 VAC/DC UL

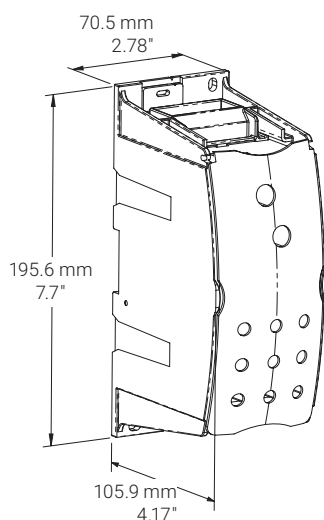







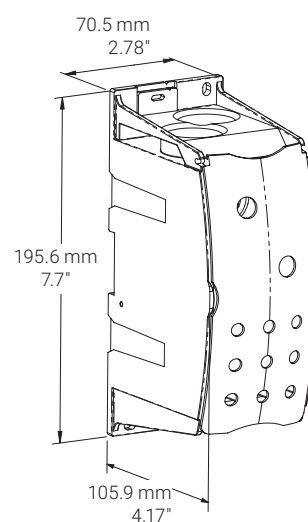



UD2C9C1250AL
1740 A – IEC
950 A – 



2 câbles – 9 câbles

- Icw kA rms 1s: 84
- Ipk kA: 73.5
- Ui: 1000 VAC IEC
- Ui: 1500 VDC IEC
- Vin: 1000 VAC/DC UL















Métrique				
	Nbre de sorties	Conducteurs	Section mm ²	Ø mm
	x1 	Flexibar Advanced IBSB Advanced	6x24x1-10x50x1 120-240	N/A
	x9 		10-95	13.5



Impérial				
	Nbre de sorties	Conducteurs	Section AWG	Ø in
	x1 	Flexibar Advanced IBSB Advanced	6X24X1-10X50X1 120-240	N/A
	x9 		8-3/0	0.53

-  Câble souple avec embout
-  Câble rigide

N° Article	Désignation		 kg/lbs
569210	UDF9C1000AL	1	0.93 / 2.05

Métrique				
	Nbre de sorties	Conducteurs	Section mm ²	Ø mm
	x2 		185-400	27.5
	x9 		10-95	13.5

Impérial				
	Nbre de sorties	Conducteurs	Section AWG	Ø in
	x2 		400-750 kcmil	1.08
	x9 		8-3/0	0.53

-  Câble souple avec embout
-  Câble rigide

N° Article	Désignation		 kg/lbs
569209	UD2C9C1250AL	1	0.93 / 2.05

Répartiteurs bipolaires et tétrapolaires

CARACTÉRISTIQUES COMMUNES

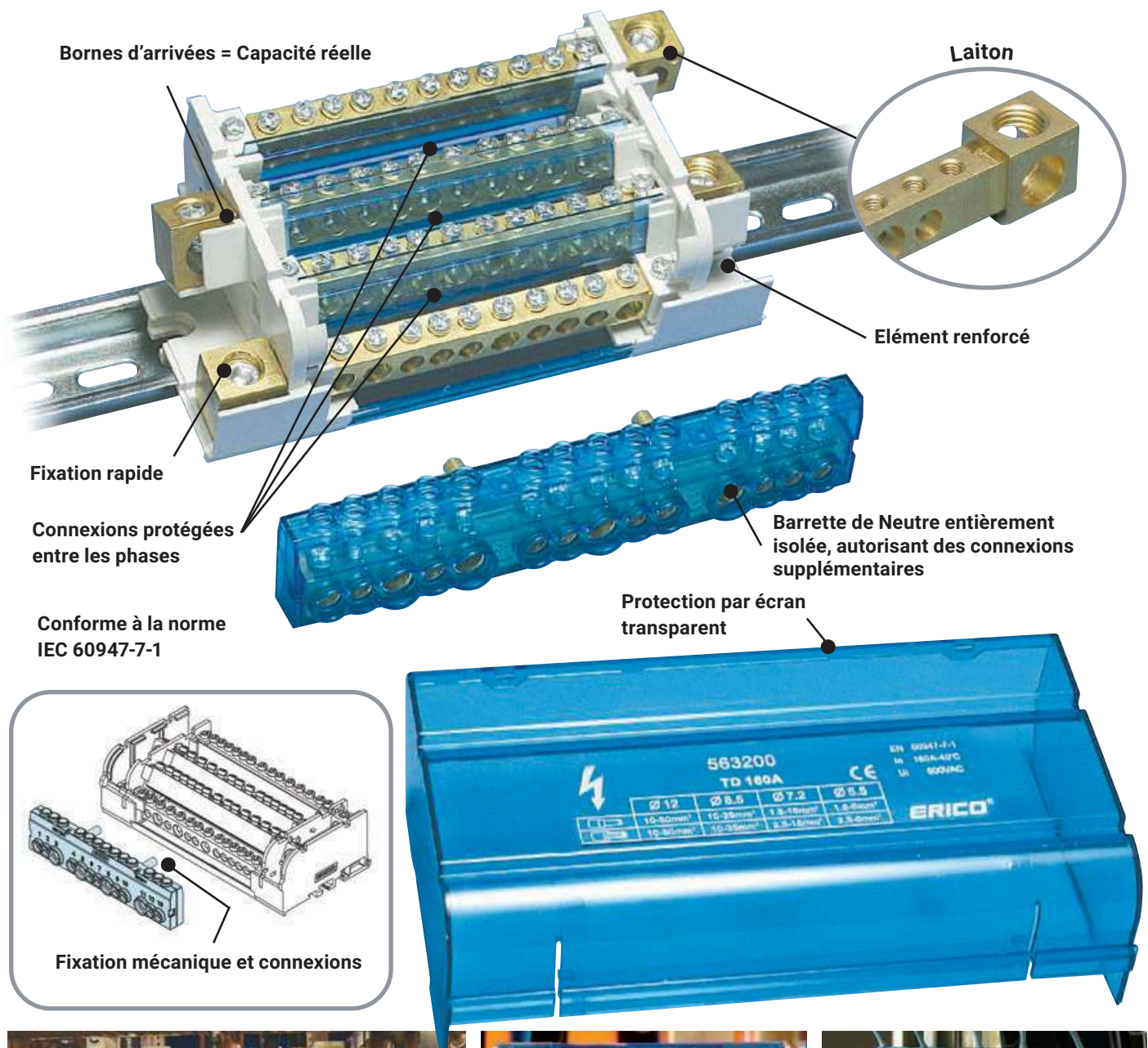

Répartiteurs bipolaires et tétrapolaires

– guide de sélection rapide

GUIDE DE SÉLECTION RAPIDE – BIPOLAIRES (TYPE BD) & TETRAPOLAIRES (TYPE TD)

Référence	N° Article	Intensité max. IEC	Intensité max. UL	Nbre de pôle / phases	Côté ligne : Nbre de connexion par phase	Côté ligne Min et Max taille du conducteur	Côté charge : Nbre de connexion par phase	Côté charge Min et Max taille du conducteur	Max voltage IEC	Max voltage UL
BD-40A	563720	40 A	–	2	2 Câbles	6–16 mm ²	15 Câbles	0.75–4 mm ²	500 VAC/DC	–
TD-40A	563740	40 A	–	4	2 Câbles	6–16 mm ²	11 Câbles	0.75–4 mm ²	500 VAC	–
BD-80-100A	563900	100 A	–	2	1 Câble	10–25 mm ²	6 Câbles	(3) 0.75–4 mm ² (3) 1.5–6 mm ²	500 VAC/DC	–
BD-80-100AL	563910	100 A	–	2	2 Câbles	10–25 mm ²	13 Câbles	(6) 0.75–4 mm ² (7) 1.5–6 mm ²	500 VAC/DC	–
TD-80-100A	563920	100 A	–	4	1 Câble	10–25 mm ²	6 Câbles	(3) 0.75–4 mm ² (3) 1.5–6 mm ²	500 VAC	–
TD-80-100AL	563930	100 A	–	4	2 Câbles	10–25 mm ²	9 Câbles	(4) 0.75–4 mm ² (5) 1.5–6 mm ²	500 VAC	–
TD-80-100ALL	563940	100 A	–	4	2 Câbles	10–25 mm ²	13 Câbles	(6) 0.75–4 mm ² (7) 1.5–6 mm ²	500 VAC	–
BD-100-125A	563800	125 A	–	2	1 Câble	10–35 mm ²	6 Câbles	(5) 1.5–6 mm ² (1) 6–16 mm ²	690 VAC/DC	–
BD-100-125AL	563810	125 A	–	2	1 Câble	10–35 mm ²	14 Câbles	(11) 1.5–6 mm ² (3) 6–16 mm ²	690 VAC/DC	–
TD-100-125A	563820	125 A	–	4	1 Câble	10–35 mm ²	6 Câbles	(5) 1.5–6 mm ² (1) 6–16 mm ²	690 VAC	–
TD-100-125AL	563830	125 A	–	4	1 Câble	10–35 mm ²	10 Câbles	(7) 1.5–6 mm ² (3) 6–16 mm ²	690 VAC	–
TD-100-125ALL	563840	125 A	–	4	1 Câble	10–35 mm ²	14 Câbles	(11) 1.5–6 mm ² (1) 6–16 mm ² (2) 10–25 mm ²	690 VAC	–
TD-160A	563200	160 A	–	4	1 Câble	10–50 mm ²	11 Câbles	(1) 2.5–6 mm ² (7) 2.5–16 mm ² (3) 10–35 mm ²	690 VAC	–
TD-160AL	563990	160 A	–	4	1 Câble	10–50 mm ²	11 Câbles	(8) 2.5–16 mm ² (3) 10–35 mm ²	690 VAC	–
TDL-400A	563995	400 A	400 A	4	1 Câble or 1 Flexibar	35–120 mm ² 1/0–250 kcmil Flexibar 6x24x1 max	14 Câbles	(1) 10–50 mm ² (2) 10–35 mm ² (4) 6–25 mm ² (7) 2.5–16 mm ² (1) #6–1/0 (2) #8–#1 (4) #10–#3 (7) #10–#5	1,000 VAC, 1,500 VDC	600 VAC/DC

Répartiteurs bipolaires et tétrapolaires

BD 40 A
BD 80/100 A



TD 40 A
TD 80/100 A



NB 125 A
NB 160 A

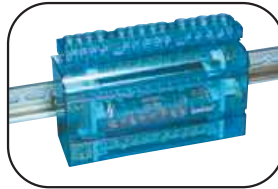
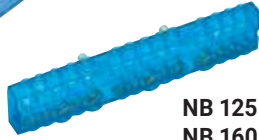

- Encombrement mini pour une puissance maxi
- Connexions faciles
- Protection par écran transparent
- Auto extinguable UL 94V-0
- Connexions protégées
- Montage rapide et simple sur rail ou sur platine*
- Sans Halogène
- Conformité RoHS
- IEC 60947-7-1

BI ET TÉTRA 40 A

Bipolaire BD 40 A

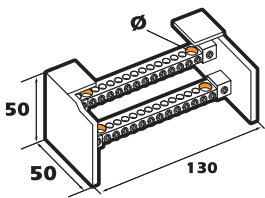

I = 40 A IEC
• I_{cw} kA rms 1s: 4.5
• I_{pk} kA: 22
• U_i: 500 VCA/CC

BD 40 A - 16 DÉPARTS

	mm ²	mm ²		Ø mm
	6-16	4-10	x2	6
	1.5-4	0.75-4	x15	4.3

Tétrapolaire TD 40 A

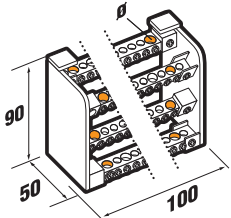

I = 40 A IEC
• I_{cw} kA rms 1s: 4.5
• I_{pk} kA: 22
• U_i: 500 V_{CA}

TD 40 A - 12 DÉPARTS

	mm ²	mm ²		Ø mm
	6-16	4-10	x2	6
	1.5-4	0.75-4	x11	4.3

* Entraxe de perçage :
• BD 40 A = 110 mm
• TD 40 A = 80 mm

N° Article	Désignation			kg/lbs
563720	BD 40 A	1		0.22/0.49
563740	TD 40 A	1		0.33/0.73

- Câble souple avec embout
- Câble rigide

BI ET TÉTRA 80/100 A

Bipolaire BD 80/100 A

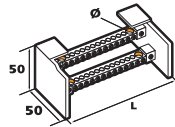

I = 100 A IEC
• I_{cw} kA rms 1s: 4.5
• I_{pk} kA: 20
• U_i: 500 VCA/CC

BD 80/100 A - 6 DÉPARTS

	mm ²	mm ²		Ø mm
	10-25	10-25	x1	8.5
	1.5-4	0.75-4	x3	4.5
	2.5-6	1.5-6	x3	5.5

BD 80/100 AL - 14 DÉPARTS

	10-25	10-25	x2	8.5
	1.5-4	0.75-4	x6	4.5
	2.5-6	1.5-6	x7	5.5

Tétrapolaire TD 80/100 A

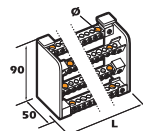

I = 100 A IEC
• I_{cw} kA rms 1s: 4.5
• I_{pk} kA: 20
• U_i: 500 V_{CA}

TD 80/100 A - 6 DÉPARTS

	10-25	10-25	x1	8.5
	1.5-4	0.75-4	x3	4.5
	2.5-6	1.5-6	x3	5.5

TD 80/100 AL - 10 DÉPARTS

	10-25	10-25	x2	8.5
	1.5-4	0.75-4	x4	4.5
	2.5-6	1.5-6	x5	5.5

TD 80/100 ALL - 14 DÉPARTS

	10-25	10-25	x2	8.5
	1.5-4	0.75-4	x6	4.5
	2.5-6	1.5-6	x7	5.5

* Entraxe de perçage :
• BD 80/100 A = 45 mm
• BD 80/100 AL = 110 mm
• TD 80/100 A = 45 mm
• TD 80/100 AL = 80 mm
• TD 80/100 ALL = 110 mm

N° Article	Désignation			L
563900	BD 80/100 A	1	0.11	64
563910	BD 80/100 AL	1	0.21	130
563920	TD 80/100 A	1	0.21	64
563930	TD 80/100 AL	1	0.31	100
563940	TD 80/100 ALL	1	0.40	130

BORNIER NEUTRE

- Augmente la capacité de câblage
- Connexion directe
- Solide assemblage mécanique
- Isolation translucide

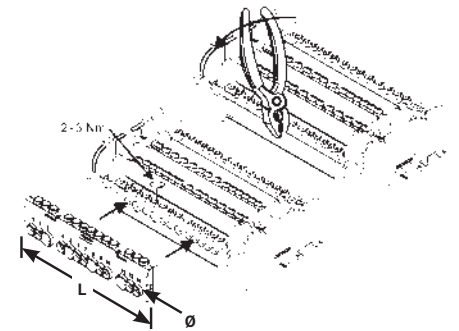

illustration pour installer la barre neutre

Bornier Neutre 563841	→	563830 - Barreau laiton massif
	→	563840 - Barreau laiton massif
Bornier Neutre 563201	→	563200 - Barreau laiton massif
	→	563990 - Barreau laiton massif

NB 125 A

I = 125 A IEC
• I_{cw} kA rms 1s: 4.5
• I_{pk} kA: 30

	mm ²	mm ²		Ø mm
	10-25	6-16	x3	7.5
	2.5-6	1.5-6	x9	5.5

NB 160 A

I = 160 A IEC
• I_{cw} kA rms 1s: 6.2
• I_{pk} kA: 35

	mm ²	mm ²		Ø mm
	10-35	10-25	x4	8.5
	2.5-16	1.5-16	x10	7.2

N° Article	Désignation	L		
563841	NB 125 A	142	10	0.17
563201	NB 160 A	170	10	0.20

Répartiteurs bipolaires et tétrapolaires

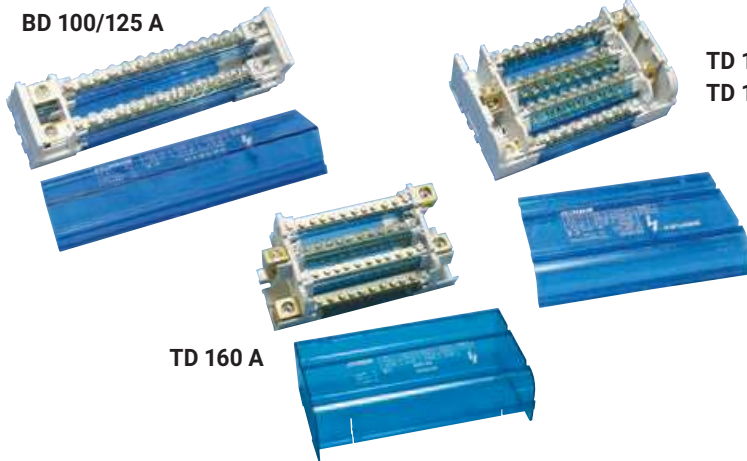

TD 100/125 A
TD 160 AL

- Connexions faciles: entrées séparées des départs
- Borniers de Neutre: 125 & 160 A
- Montage sur rail ou sur platine*
- Bornes d'arrivées: connexions sécurisées
- Barreau en laiton massif
- Amélioration de la résistance aux Icc jusqu'à 35 kA (IPK)
- Assemblage mécanique robuste
- IEC 60947-7-1

BI ET TÉTRA 100/125 A

Bipolaire BD 100/125 A

I = 125 A IEC
• Ui : 690 VCA/CC

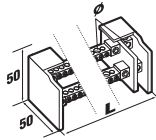

BD 100/125 A - 6 DÉPARTS

	mm ²	mm ²		Ø mm
	10-35	10-35	x1	9.5
	2.5-6	1.5-6	x5	5.5
	10-25	6-16	x1	7.5

BD 100/125 AL - 14 DÉPARTS

	mm ²	mm ²		Ø mm
	10-35	10-35	x1	9.5
	2.5-6	1.5-6	x11	5.5
	10-25	6-16	x3	7.5

TÉTRAPOLAIRE TD 100/125 A

I = 125 A IEC
• Ui : 690 V_{CA}

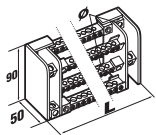

TD 100/125 A - 6 DÉPARTS

	mm ²	mm ²		Ø mm
	10-35	10-35	x1	9.5
	2.5-6	1.5-6	x5	5.5
	10-25	6-16	x1	7.5

TD 100/125 AL - 10 DÉPARTS

	10-35	10-35	x1	9.5
	2.5-6	1.5-6	x7	5.5
	10-25	6-16	x3	7.5

TD 100/125 ALL - 14 DÉPARTS

	10-35	10-35	x1	9.5
	2.5-6	1.5-6	x11	5.5
	10-25	6-16	x1	7.5
	10-35	10-25	x2	8.5

* Entraxe de perçage :

- BD 100/125 A = 74 mm
- BD 100/125 AL = 142 mm

- TD 100/125 A = 89 mm
- TD 100/125 AL = 127 mm
- TD 100/125 ALL = 162 mm

N° Article	Désignation	I _{cw}	I _{pk}			L
563800	BD 100/125 A	4.5	30	1	0.16	94
563810	BD 100/125 AL	4.5	25	1	0.27	162
563820	TD 100/125 A	4.5	30	1	0.33	109
563830	TD 100/125 AL	4.5	30	1	0.44	147
563840	TD 100/125 ALL	4.5	21	1	0.55	182

TÉTRAPOLAIRE 160 A

TD 160 A

I = 160 A IEC
• I_{cw} kA rms 1s : 8.2
• I_{pk} kA : 35
• Ui : 690 V_{CA}

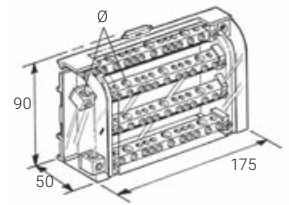

TD 160 A : 11 DÉPARTS

	mm ²	mm ²		Ø mm
	10-50	10-50	x1	12
	10-35	10-25	x3	8.5
	2.5-16	1.5-16	x7	7.2
	2.5-6	1.5-6	x1	5.5

* Entraxe de perçage: 160 mm

N° Article	Désignation		
563200	TD 160A	1	0.606

TÉTRAPOLAIRE 160 A

TD 160 A

I = 160 A IEC
• I_{cw} kA rms 1s : 8.2
• I_{pk} kA : 35
• Ui : 690 V_{CA}

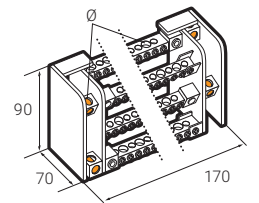

TD 160 AL : 11 DÉPARTS

	mm ²	mm ²		Ø mm
	10-50	10-50	x1	12
	10-35	10-25	x3	8.5
	2.5-16	1.5-16	x8	7

* Entraxe de perçage : 150 mm.

N° Article	Désignation		
563990	TD 160AL	1	0.74

Répartiteurs tétrapolaires – TDL

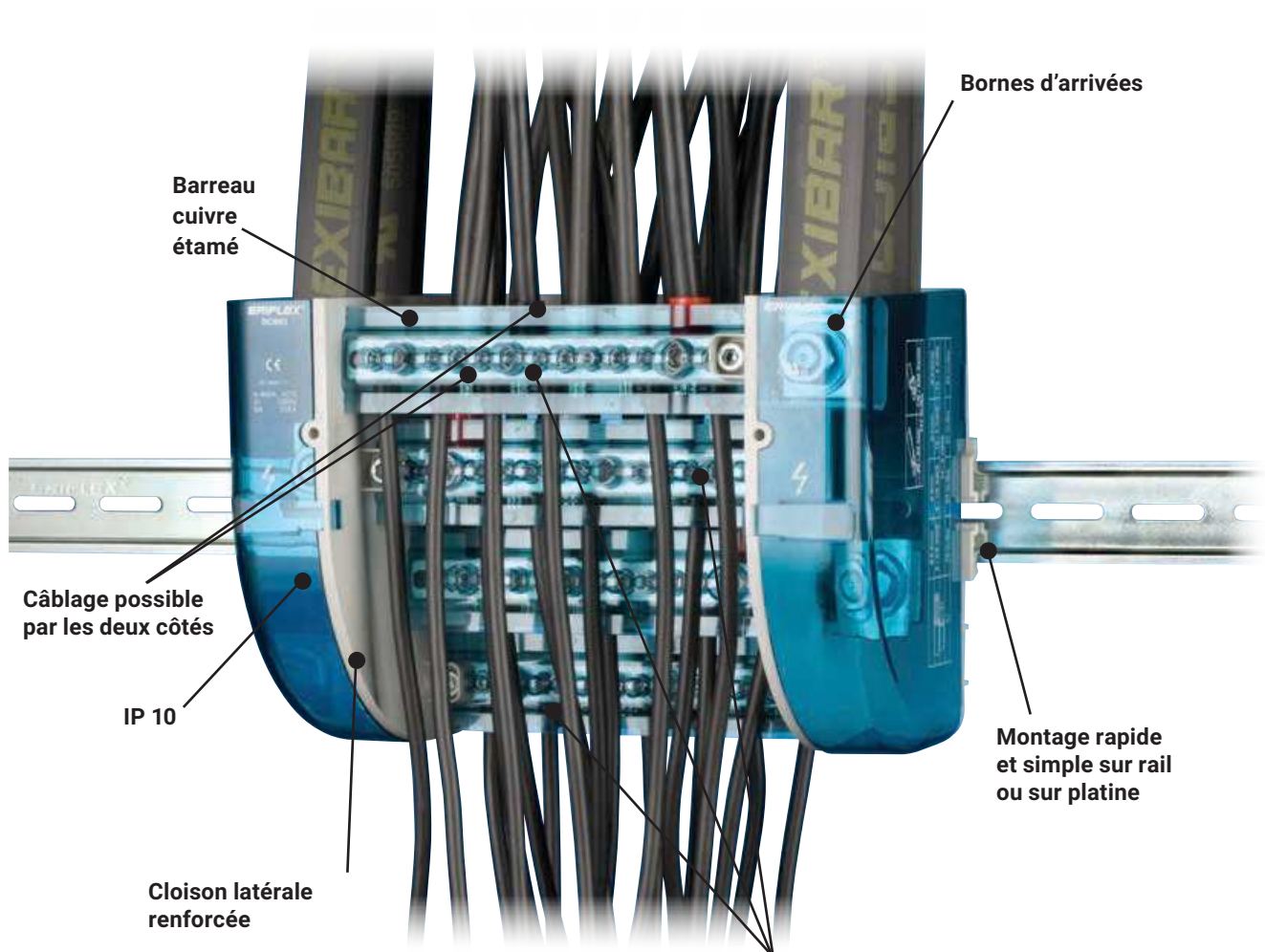

Inspection visuelle du câblage et des connexions



- Testé et certifié suivant CEI 60947-7-1 $U_i = 1000 \text{ V AC}$
- Certifié UL® pour USA & Canada
- UL 1059 $U_i = 600\text{V}$
- Sans Halogène
- UL94 V-0
- Conformité RoHS
- Conformité CE
- Conformité EAC

Répartiteurs tétrapolaires – TDL

TDL 250/400A

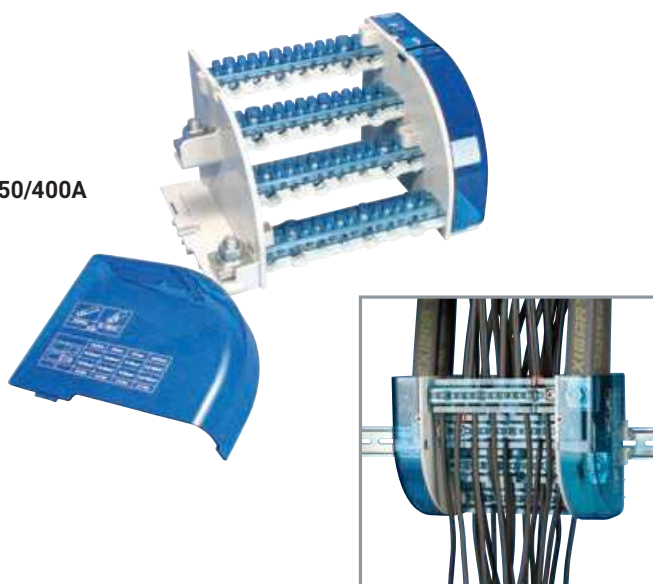







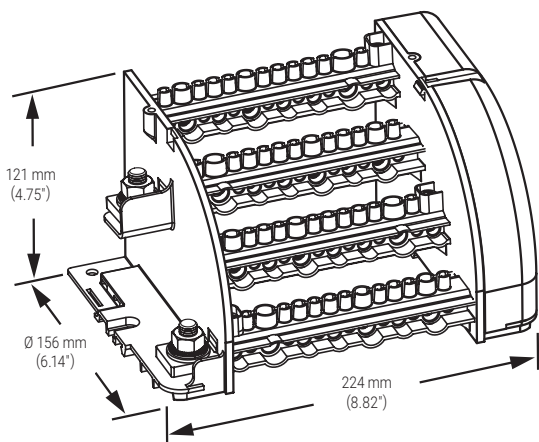
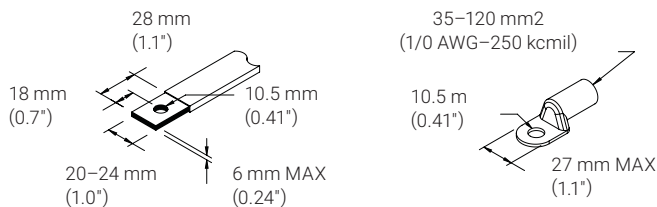





- Connexions faciles: entrées séparées des départs
- Bornes d'arrivées grande capacité: connexions sûres
- Connexions d'arrivée avec Flexibar, IBS, Câbles
- Câblage par les deux côtés
- Barreaux Cuivre étamé: Câbles cuivre ou Aluminium
- Inspection visuelle du câblage et vérification des connexions
- Nouveau concept: les barres cuivre monobloc assurent la fiabilité
- Assemblage robuste
- IP 10 Sécurité contacts involontaires de la main
- Connexions avec ou sans embout de câblage
- Montage rapide et simple sur rail ou sur platine
- Sans Halogène

TDL 250/400A 400 A – IEC /



- Icw kA rms 1s : 23
- Ipk kA : 51
- Ui : 1000 VAC
1500 VDC IEC
- Vin : 600 V UL



Métrique				
	Flexibar, IBS (width)	 mm ²	 mm ²	
	20-24 mm	35-120	35-120	x1
	-	10-50	10-35	x1
	-	10-35	10-25	x2
	-	6-25	6-16	x4
	-	2.5-16	2.5-10	x7

Impérial			
	Flexibar, IBS (width)	AWG	
	20-24 mm	1/0 - 250	x1
	-	6 - 1/0	x1
	-	8 - 1	x2
	-	10 - 3	x4
	-	10 - 5	x7

N° Article	Désignation		 kg/lbs
563995	TDL250A	1	1.69 / 3.73

-  Câble souple avec embout
-  Câble rigide

Blocs de jonction – séries SB

CARACTÉRISTIQUES COMMUNES

Solution économique et compact

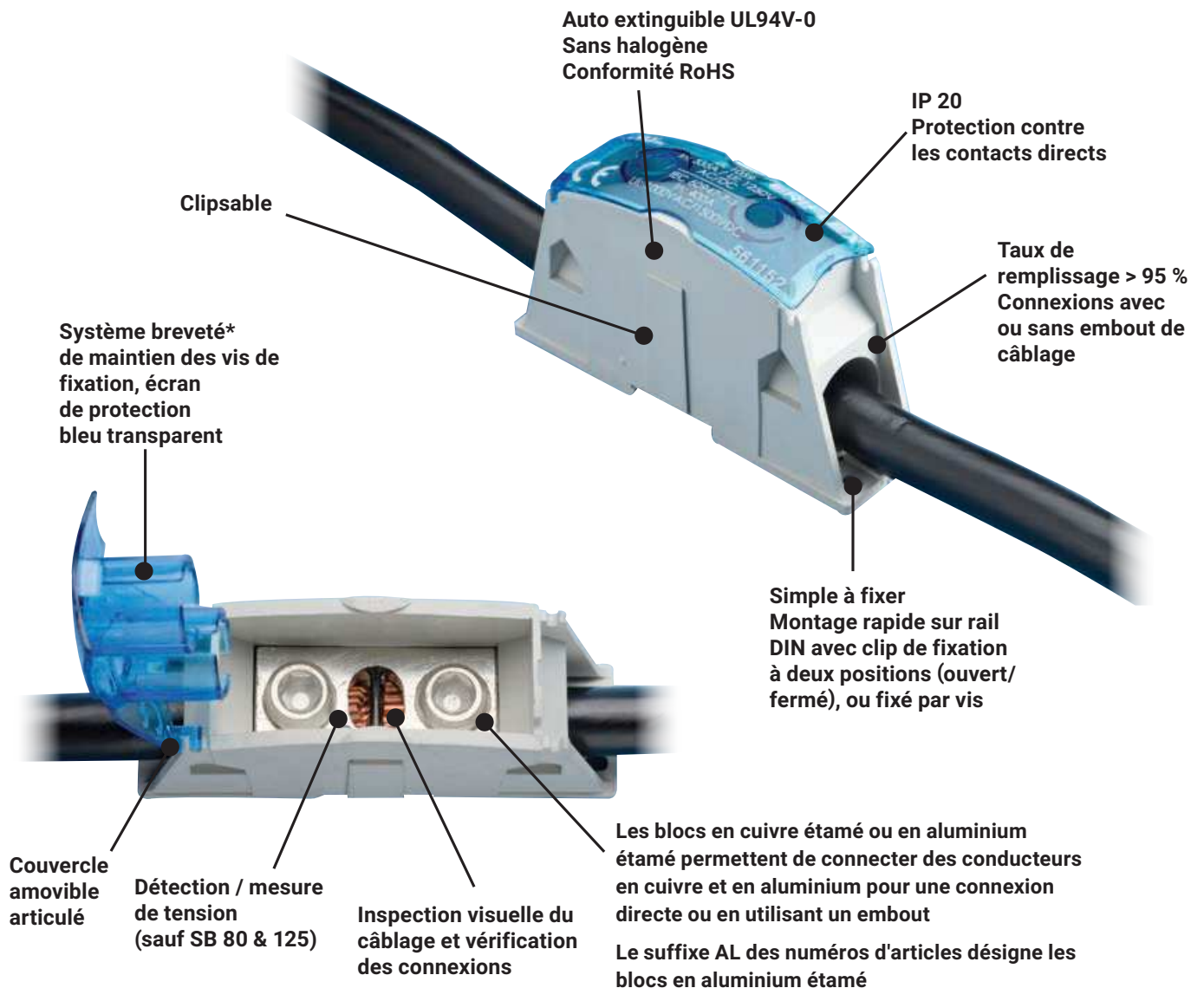

- Testé et certifié suivant CEI 60947-7-1 $U_i = 1000 \text{ V AC} / 1500 \text{ V DC}$
- UL 1059 Recognized ou UL 1953 Listed en fonction du model
- Haute résistance aux courts-circuits – 100 kA SCCR(UL)
- Sans Halogène
- Conformité RoHS



Blocs de jonction – guide de sélection rapide

GUIDE DE SÉLECTION RAPIDE – BLOCS DE JONCTION (TYPE SB)

Référence	N° Article	Intensité max. IEC	Intensité max. UL	Côté ligne : Nbre de connexion		Côté ligne Min et Max taille du conducteur	Côté charge : Nbre de connexion		Côté charge Min et Max taille de conducteur	Max voltage IEC	Max voltage UL
SB80AL	561160	105 A	85 A		1 Câble	6–16 mm ² #16–#4		1 Câble	6–16 mm ² #16–#4	1,000 VAC 1,500 VDC	1,000 VAC/DC
SB80	561150	110 A	85 A		1 Câble	6–16 mm ² #16–#4		1 Câble	6–16 mm ² #16–#4	1,000 VAC 1,500 VDC	1,000 VAC/DC
SB125	561158	170 A	150 A		1 Câble	10–35 mm ² #8–1/0		1 Câble	10–35 mm ² #8–1/0	1,000 VAC 1,500 VDC	1,250 VAC/DC
SB125AL	561161	185 A	150 A		1 Câble	10–35 mm ² #8–1/0		1 Câble	10–35 mm ² #8–1/0	1,000 VAC 1,500 VDC	1,250 VAC/DC
SB160AL	561162	230 A	200 A		1 Câble	35–70 mm ² #2–3/0		1 Câble	35–70 mm ² #2–3/0	1,000 VAC 1,500 VDC	1,000 VAC/DC
SB160	561151	250 A	200 A		1 Câble	35–70 mm ² #2–3/0		1 Câble	35–70 mm ² #2–3/0	1,000 VAC 1,500 VDC	1,000 VAC/DC
SB250AL	561163	400 A	255 A		1 Câble	35–120 mm ² #6–250 kcmil		1 Câble	35–120 mm ² #6–250 kcmil	1,000 VAC, 1,500 VDC	1,250 VAC/DC
SB250	561159	400 A	255 A		1 Câble	35–120 mm ² #6–250 kcmil		1 Câble	35–120 mm ² #6–250 kcmil	1,000 VAC, 1,500 VDC	1,250 VAC/DC
SB2C250	561170	550 A	255 A		1 Câble	35–120 mm ² #6–250 kcmil		2 Câbles	(2) 35–120 mm ² (2) #6–250 kcmil	1,000 VAC, 1,500 VDC	1,000 VAC/DC
SBF250	561171	380 A 330 A	255 A		Conducteur plat	Flexibar 2X20X1– 5X20X1 IBS/IBSB 50–70 mm ²		1 Câble	35–120 mm ² #6–250 kcmil	1,000 VAC, 1,500 VDC	1,000 VAC/DC
SB2C400AL	561166	670 A	335 A		1 Câble	95–240 mm ² 3/0–400 kcmil		2 Câbles	(2) 35–120 mm ² (2) #2–250 kcmil	1,000 VAC, 1,500 VDC	1,000 VAC/DC
SB2C400	561154	600 A	335 A		1 Câble	95–240 mm ² 3/0–400 kcmil		2 Câbles	(2) 35–120 mm ² (2) #2–250 kcmil	1,000 VAC, 1,500 VDC	1,000 VAC/DC
SBF400AL	561165	510 A 450 A	335 A 240 A		Conducteur plat	Flexibar 2x20x1–5x24x1 IBS/IBSB 100 mm ²		1 Câble	95–240 mm ² 3/0–400 kcmil	1,000 VAC, 1,500 VDC	1,000 VAC/DC
SBF400	561153	445 A 405 A	335 A		Conducteur plat	Flexibar 2x20x1–5x24x1 IBS/IBSB 100 mm ²		1 Câble	95–240 mm ² 3/0–400 kcmil	1,000 VAC, 1,500 VDC	1,000 VAC/DC
SBF2C400AL	561167	550 A 480 A	335 A		Conducteur plat	Flexibar 2x20x1–5x24x1 IBS/IBSB 100 mm ²		2 Câbles	(2) 35–120 mm ² (2) #2–250 kcmil	1,000 VAC, 1,500 VDC	1,000 VAC/DC
SBF2C400	561155	560 A 500 A	335 A		Conducteur plat	Flexibar 2x20x1–5x24x1 IBS/IBSB 100 mm ²		2 Câbles	(2) 35–120 mm ² (2) #2–250 kcmil	1,000 VAC, 1,500 VDC	1,000 VAC/DC
SBF2C250	561172	500 A 430 A	255 A		Conducteur plat	Flexibar 2X20X1– 5X20X1 IBS/IBSB 50–70 mm ²		2 Câbles	(2) 35–120 mm ² (2) #6–250 kcmil	1,000 VAC, 1,500 VDC	1,000 VAC/DC
SB400AL	561164	610 A	335 A		1 Câble	95–240 mm ² 3/0–400 kcmil		1 Câble	95–240 mm ² 3/0–400 kcmil	1,000 VAC, 1,500 VDC	1,250 VAC/DC
SB400	561152	500 A	335 A		1 Câble	95–240 mm ² 3/0–400 kcmil		1 Câble	95–240 mm ² 3/0–400 kcmil	1,000 VAC, 1,500 VDC	1,250 VAC/DC
SB630AL	561168	860 A	545 A		1 Câble	240–500 mm ² 400–1,000 kcmil		1 Câble	240–500 mm ² 400–1,000 kcmil	1,000 VAC, 1,500 VDC	1,250 VAC/DC
SB630	561156	870 A	545 A		1 Câble	240–500 mm ² 400–1,000 kcmil		1 Câble	240–500 mm ² 400–1,000 kcmil	1,000 VAC, 1,500 VDC	1,250 VAC/DC
SBF630AL	561169	760 A 750 A	490 A 410 A		Conducteur plat	Flexibar 2x20x1–8x32x1 IBS/IBSB 100–240 mm ²		1 Câble	240–500 mm ² 400–1,000 kcmil	1,000 VAC, 1,500 VDC	1,000 VAC/DC
SBF630	561157	805 A 800 A	545 A		Conducteur plat	Flexibar 2x20x1–8x32x1 IBS/IBSB 100–240 mm ²		1 Câble	240–500 mm ² 400–1,000 kcmil	1,000 VAC, 1,500 VDC	1,000 VAC/DC
SBF2C630AL	561173	930 A 910 A	760 A		Conducteur plat	Flexibar 2x20x1–8x32x1 IBS/IBSB 240 mm ²		2 Câbles	(2) 35–240 mm ² (2) #2–500 kcmil	1,000 VAC, 1,500 VDC	1,000 VAC/DC
SB2C1000AL	561174	1,020 A	545 A		1 Câble	240–500 mm ² 400–1,000 kcmil		2 Câbles	(2) 35–300 mm ² (2) #2–600 kcmil	1,000 VAC, 1,500 VDC	1,000 VAC/DC
SB2C2C1000AL	561175	1,150 A	840 A		2 Câbles	(2) 35–300 mm ² (2) #2–600 kcmil		2 Câbles	(2) 35–300 mm ² (2) #2–600 kcmil	1,000 VAC, 1,500 VDC	1,000 VAC/DC
SBF3C1000AL	561176	1,420 A	1,260 A		Conducteur plat	Flexibar 2X20X1– 10X50X1		3 Câbles	(3) 35–300 mm ² (3) #2–600 kcmil	1,000 VAC, 1,500 VDC	1,000 VAC/DC
SBF4C1600AL	561177	1,940 A	1,680 A		Conducteur plat	Flexibar 6X50X1– 10X80X1		4 Câbles	(4) 35–300 mm ² (4) #2–600 kcmil	1,000 VAC, 1,500 VDC	1,000 VAC/DC

Blocs de jonction de puissance



SB80AL



SB80

SB80AL
105 A – IEC
85 A – US

1 câble – 1 câble

- Icw kA rms 1s: 3.0
- Ipk kA: 22
- Ui: 1000 VAC IEC
- Ui: 1500 VDC IEC
- Vin: 1000 VAC/DC UL

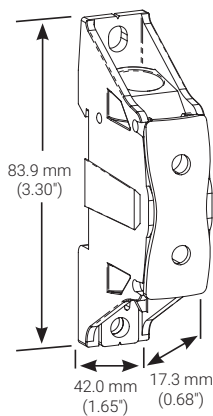

SB80
110 A – IEC
85 A –

1 câble – 1 câble

- Icw kA rms 1s: 3.0
- Ipk kA: 25
- Ui: 1000 V AC IEC
- Ui: 1500 V DC IEC
- Vin: 1000 VAC/DC UL

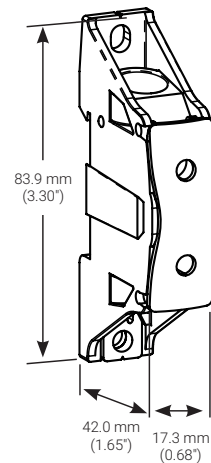

Métrique				
	Nbre de sorties	Conducteurs	Section mm ²	Ø mm
	x1	 	2.5–6 6–16 6–16	8.2
	x1	 	2.5–6 6–16 6–16	8.2

Métrique				
	Nbre de sorties	Conducteurs	Section mm ²	Ø mm
	x1	 	2.5–6 6–16 6–16	8.2
	x1	 	2.5–6 6–16 6–16	8.2

Impérial				
	Nbre de sorties	Conducteurs	Section AWG	Ø in
	x1	 	#16–#10 #16–#4	0.32
	x1	 	#16–#10 #16–#4	0.32

Impérial				
	Nbre de sorties	Conducteurs	Section AWG	Ø in
	x1	 	#16–#10 #16–#4 #16–#4	0.32
	x1	 	#16–#10 #16–#4 #16–#4	0.32

- Câble rigide métrique / AWG
- Câble souple avec embout
- Câble rigide

- Câble rigide métrique / AWG
- Câble souple avec embout
- Câble rigide

N° Article	Désignation		kg/lbs
561160	SB80AL	1	0.036 / 0.08

N° Article	Désignation		kg/lbs
561150	SB 80	1	0.04/0.10

Blocs de jonction de puissance



SB125



SB125AL

SB125
170 A – IEC
150 A –

1 câble – 1 câble

- Icw kA rms 1s : 6.0
- Ipk kA : 25
- Ui : 1000 V AC IEC
- Ui : 1500 V DC IEC
- Vin : 1250 VAC/DC UL

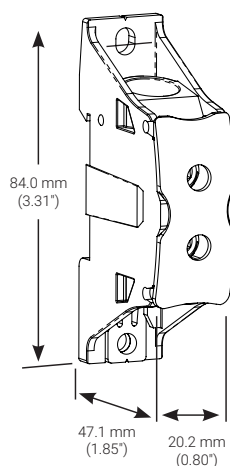

SB125AL
185 A – IEC
150 A –

1 câble – 1 câble

- Icw kA rms 1s : 6.0
- Ipk kA : 22
- Ui : 1000 VAC IEC
- Ui : 1500 VDC IEC
- Vin : 1250 VAC/DC UL

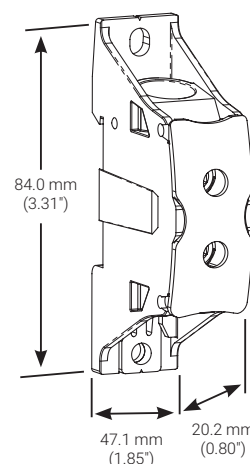

Métrique				
	Nbre de sorties	Conducteurs	Section mm ²	Ø mm
	x1		10–35	10.1
	x1		10–35	10.1

Métrique				
	Nbre de sorties	Conducteurs	Section mm ²	Ø mm
	x1		10–35	10.1
	x1		10–35	10.1

Impérial				
	Nbre de sorties	Conducteurs	Section AWG	Ø in
	x1		#8–1/0	0.40
	x1		#8–1/0	0.40

Impérial				
	Nbre de sorties	Conducteurs	Section AWG	Ø in
	x1		#8–1/0	0.40
	x1		#8–1/0	0.40

Câble souple avec embout

Câble rigide

Câble souple avec embout

Câble rigide

N° Article	Désignation		kg/lbs
561158	SB 125	1	0.07/0.15

N° Article	Désignation		kg/lbs
561161	SB125AL	1	0.045 / 0.1

Blocs de jonction de puissance



SB160AL





SB160

SB160AL
230 A – IEC
200 A – 

1 câble – 1 câble

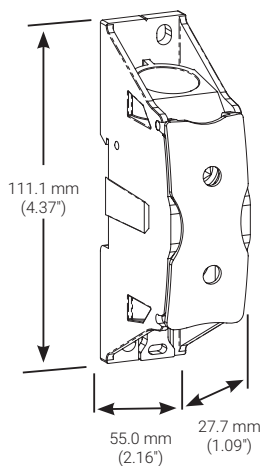
- Icw kA rms 1s: 14.4
- Ipk kA: 42
- Ui: 1000 VAC IEC
- Ui: 1500 VDC IEC
- Vin: 1000 VAC/DC UL









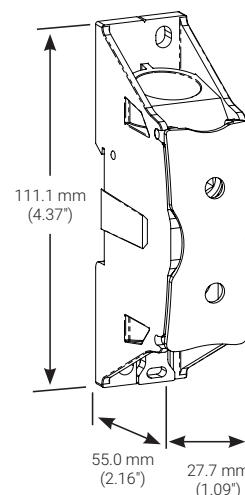





SB160
250 A – IEC
200 A – 







1 câble – 1 câble







- Icw kA rms 1s: 14.4
- Ipk kA: 42
- Ui: 1000 V AC IEC
- Ui: 1500 V DC IEC
- Vin: 1000 VAC/DC UL



Métrique				
	Nbre de sorties	Conducteurs	Section mm ²	Ø mm
	x1 		35-70	14.0
	x1 		35-70	14.0

Métrique				
	Nbre de sorties	Conducteurs	Section mm ²	Ø mm
	x1 		35-70	14.0
	x1 		35-70	14.0

Impérial				
	Nbre de sorties	Conducteurs	Section AWG	Ø in
	x1 		#2-3/0	0.55
	x1 		#2-3/0	0.55

Impérial				
	Nbre de sorties	Conducteurs	Section AWG	Ø in
	x1 		#2-3/0	0.55
	x1 		#2-3/0	0.55

 Câble souple avec embout

 Câble rigide

 Câble souple avec embout

 Câble rigide

N° Article	Désignation		 kg/lbs
561162	SB160AL	1	0.1 / 0.22

N° Article	Désignation		 kg/lbs
561151	SB 160	1	0.18/0.40

Blocs de jonction de puissance

SB250AL



SB250



SB250AL
400 A – IEC
255 A – 

1 câble – 1 câble

- Icw kA rms 1s: 14.4
- Ipk kA: 42
- Ui: 1000 VAC IEC
- Ui: 1500 VDC IEC
- Vin: 1250 VAC/DC UL

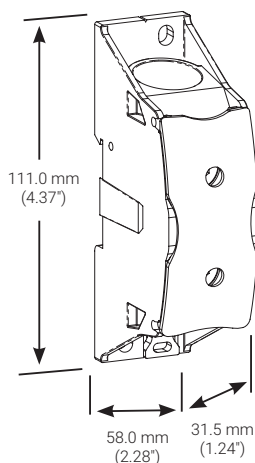







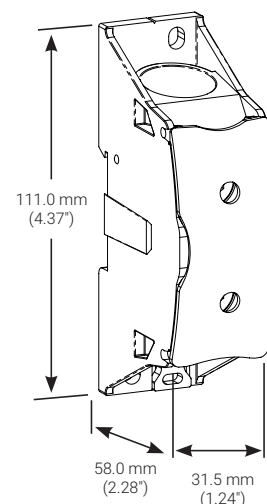

SB250
400 A – IEC
255 A – 

1 câble – 1 câble

- Icw kA rms 1s: 14.4
- Ipk kA: 42
- Ui: 1000 V AC IEC
- Ui: 1500 V DC IEC
- Vin: 1250 VAC/DC UL







Métrique				
	Nbre de sorties	Conducteurs	Section mm ²	Ø mm
	x1		35–120	15.1
	x1		35–120	15.1





Impérial				
	Nbre de sorties	Conducteurs	Section AWG	Ø in
	x1		#6–250 kcmil	0.59
	x1		#6–250 kcmil	0.59

 Câble souple avec embout

 Câble rigide

N° Article	Désignation		 kg/lbs
561163	SB250AL	1	0.13 / 0.29

Métrique				
	Nbre de sorties	Conducteurs	Section mm ²	Ø mm
	x1		35–120	15.1
	x1		35–120	15.1

Impérial				
	Nbre de sorties	Conducteurs	Section AWG	Ø in
	x1		#6–250 kcmil	0.59
	x1		#6–250 kcmil	0.59

 Câble souple avec embout

 Câble rigide

N° Article	Désignation		 kg/lbs
561159	SB 250	1	0.30/0.66

Blocs de jonction de puissance



Pour améliorer la distance d'espacement selon UL1953

SB2C250
550 A – IEC
255 A –

1 câble – 2 câbles

- Icw kA rms 1s: 14.4
- Ipk kA: 42
- Ui: 1000 VAC IEC
- Ui: 1500 VDC IEC
- Vin: 1000 VAC/DC UL

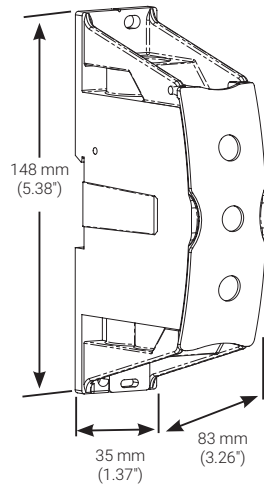

SBF250
380 A – IEC (Flexibar Advanced)
330 A – IEC (IBSB Advanced)
255 A –

Conducteur plat – 1 câble

- Icw kA rms 1s: 14.4
- Ipk kA: 42
- Ui: 1000 VAC IEC
- Ui: 1500 VDC IEC
- Vin: 1000 VAC/DC UL

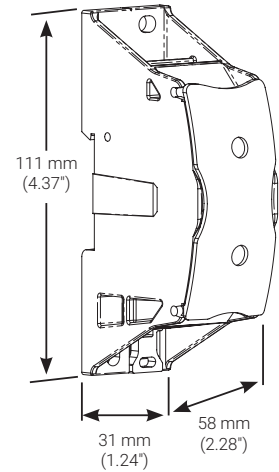

Métrique				
	Nbre de sorties	Conducteurs	Section mm ²	Ø mm
	x1		35–120	15.1
	x2		2x35–120	15.1

Impérial				
	Nbre de sorties	Conducteurs	Section AWG	Ø in
	x1		#6–250 kcmil	0.594
	x2		2x #6–250 kcmil	0.594

- Câble souple avec embout
- Câble rigide

N° Article	Désignation		kg/lbs
561170	SB2C250	1	0.499 / 1.1

Métrique				
	Nbre de sorties	Conducteurs	Section mm ²	Ø mm
	x1	Flexibar Advanced IBSB Advanced	2x20x1–5x20x1 50–70	N/A
	x1		35–120	15.1

Impérial				
	Nbre de sorties	Conducteurs	Section AWG	Ø in
	x1	Flexibar Advanced IBSB Advanced	2x20x1–5x20x1 50–70	N/A
	x1		#6–250 kcmil	0.594

- Câble souple avec embout
- Câble rigide

N° Article	Désignation		kg/lbs
561171	SBF250	1	0.272 / 0.6
561178	SB250SPCR	5	

Blocs de jonction de puissance



SB2C400AL



SB2C400

SB2C400AL
670 A – IEC
335 A – cUL[®]US

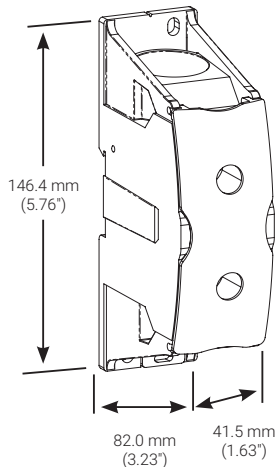

1 câble – 2 câbles

- Icw kA rms 1s: 28.8
- Ipk kA: 51
- Ui: 1000 VAC IEC
- Ui: 1500 VDC IEC
- Vin: 1000 VAC/DC UL

SB2C400
600 A – IEC
335 A – **UL**[®]

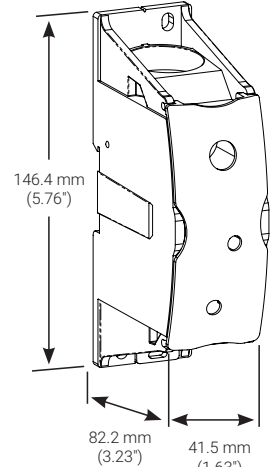

1 câble – 2 câbles

- Icw kA rms 1s: 28.8
- Ipk kA: 51
- Ui: 1000 V AC IEC
- Ui: 1500 V DC IEC
- Vin: 1000 VAC/DC UL

Métrique				
	Nbre de sorties	Conducteurs	Section mm ²	Ø mm
	x1		95–240	21.0
	x2		35–120	15.0

Métrique				
	Nbre de sorties	Conducteurs	Section mm ²	Ø mm
	x1		95–240	21.0
	x2		35–120	15.0

Impérial				
	Nbre de sorties	Conducteurs	Section AWG	Ø in
	x1		3/0–400 kcmil	0.83
	x2		#2–250 kcmil	0.59

Impérial				
	Nbre de sorties	Conducteurs	Section AWG	Ø in
	x1		3/0–400 kcmil	0.83
	x2		#2–250 kcmil	0.59

- Câble souple avec embout
- Câble rigide

- Câble souple avec embout
- Câble rigide

N° Article	Désignation		kg/lbs
561166	SB2C400AL	1	0.3 / 0.66

N° Article	Désignation		kg/lbs
561154	SB2C400	1	0.73/1.61

Blocs de jonction de puissance



SBF400AL



SBF400

SBF400AL
 510 A – IEC
 (Flexibar Advanced)
 450 A – IEC
 (IBSB Advanced)
 335 A – US
 (Flexibar Advanced)
 240 A – US
 (IBSB Advanced)
 Conducteur plat – 1 câble

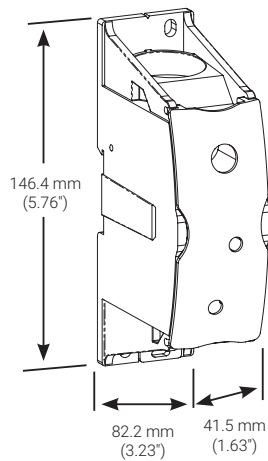

- Icw kA rms 1s: 28.8
- Ipk kA: 51
- Ui: 1000 VAC IEC
- Ui: 1500 VDC IEC
- Vin: 1000 VAC/DC UL

SBF400
 445 A – IEC
 (Flexibar Advanced)
 405 A – IEC
 (IBSB Advanced)
 335 A –

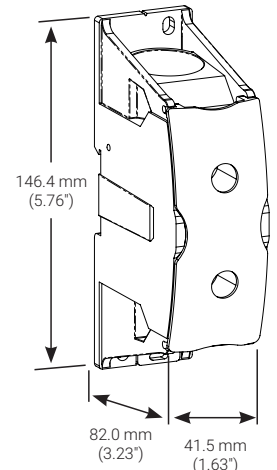

- Icw kA rms 1s: 28.8
- Ipk kA: 51
- Ui: 1000 V AC IEC
- Ui: 1500 V DC IEC
- Vin: 1000 VAC/DC UL

Métrique				
	Nbre de sorties	Conducteurs	Section mm ²	Ø mm
	x1	Flexibar Advanced IBSB Advanced	2x20x1–5x24x1 100	N/A
	x1	Flexibar Advanced IBSB Advanced	95–240	21.0

Métrique				
	Nbre de sorties	Conducteurs	Section mm ²	Ø mm
	x1	Flexibar Advanced IBSB Advanced	2x20x1–5x24x1 100	N/A
	x1	Flexibar Advanced IBSB Advanced	95–240	21.0

Impérial				
	Nbre de sorties	Conducteurs	Section AWG	Ø in
	x1	Flexibar Advanced IBSB Advanced	2x20x1–5x24x1 100	N/A
	x1	Flexibar Advanced IBSB Advanced	3/0–400 kcmil	0.83

Impérial				
	Nbre de sorties	Conducteurs	Section AWG	Ø in
	x1	Flexibar Advanced IBSB Advanced	2x20x1–5x24x1 100	N/A
	x1	Flexibar Advanced IBSB Advanced	3/0–400 kcmil	0.83

- Câble souple avec embout
- Câble rigide

- Câble souple avec embout
- Câble rigide

N° Article	Désignation		kg/lbs
561165	SBF400AL	1	0.267 / 0.59

N° Article	Désignation		kg/lbs
561153	SBF400	1	0.56/1.23

Blocs de jonction de puissance

SBF2C400AL



SBF2C400



SBF2C400AL
 550 A – IEC
 (Flexibar Advanced)
 480 A – IEC
 (IBSB Advanced)
 335 A – US

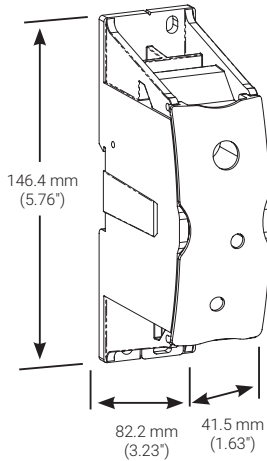

Conducteur plat – 2 câbles

- Icw kA rms 1s : 28.8
- Ipk kA : 51
- Ui : 1000 V AC IEC
- Ui : 1500 V DC IEC
- Vin : 1000 VAC/DC UL

SBF2C400
 560 A – IEC
 (Flexibar Advanced)
 500 A – IEC
 (IBSB Advanced)
 335 A –

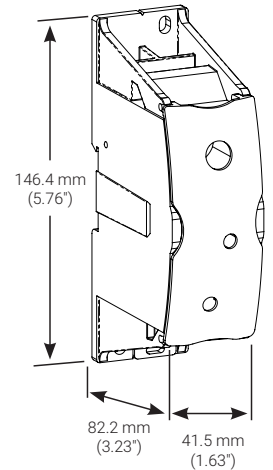

Conducteur plat – 2 câbles

- Icw kA rms 1s : 28.8
- Ipk kA : 51
- Ui : 1000 V AC IEC
- Ui : 1500 V DC IEC
- Vin : 1000 VAC/DC UL

Métrique				
	Nbre de sorties	Conducteurs	Section mm ²	Ø mm
	x1	Flexibar Advanced IBSB Advanced	2x20x1–5x24x1 100	N/A
	x2		35–120	15.0

Impérial				
	Nbre de sorties	Conducteurs	Section AWG	Ø in
	x1	Flexibar Advanced IBSB Advanced	2x20x1–5x24x1 100	N/A
	x2		#2–250 kcmil	0.59

- Câble souple avec embout
- Câble rigide

N° Article	Désignation		kg/lbs
561167	SBF2C400AL	1	0.335 / 0.74

Métrique				
	Nbre de sorties	Conducteurs	Section mm ²	Ø mm
	x1	Flexibar Advanced IBSB Advanced	2x20x1–5x24x1 100	N/A
	x2		35–120	15.0

Impérial				
	Nbre de sorties	Conducteurs	Section AWG	Ø in
	x1	Flexibar Advanced IBSB Advanced	2x20x1–5x24x1 100	N/A
	x2		#2–250 kcmil	0.59

- Câble souple avec embout
- Câble rigide

N° Article	Désignation		kg/lbs
561155	SBF2C400	1	0.76/1.67

Blocs de jonction de puissance

SBF2C250



SB400AL



SBF2C250
 500 A – IEC
 (Flexibar Advanced)
 430 A – IEC
 (IBSB Advanced)
 255 A –

Conducteur plat – 2 câbles

- Icw kA rms 1s: 14.4
- Ipk kA: 42
- Ui: 1000 VAC IEC
- Ui: 1500 VDC IEC
- Vin: 1000 VAC/DC UL

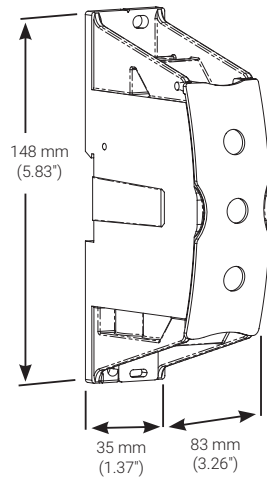

SB400AL
 610 A – IEC
 335 A –

1 câble – 1 câble

- Icw kA rms 1s: 28.8
- Ipk kA: 51
- Ui: 1000 VAC IEC
- Ui: 1500 VDC IEC
- Vin: 1250 VAC/DC UL

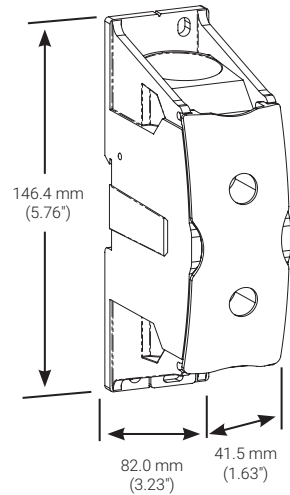

Métrique				
	Nbre de sorties	Conducteurs	Section mm ²	Ø mm
	x1	Flexibar Advanced IBSB Advanced	50–70 IBS/IBSB ADV	N/A
	x2		2x35–120	15.1

Impérial				
	Nbre de sorties	Conducteurs	Section AWG	Ø in
	x1	Flexibar Advanced IBSB Advanced	2x20x1–5x20x1 Flexibar ADV	N/A
	x2		2x #6–250 kcmil	0.594

- Câble souple avec embout
- Câble rigide

N° Article	Désignation		kg/lbs
561172	SBF2C250	1	0.499 / 1.1

Métrique				
	Nbre de sorties	Conducteurs	Section mm ²	Ø mm
	x1		95–240	21.0
	x1		95–240	21.0

Impérial				
	Nbre de sorties	Conducteurs	Section AWG	Ø in
	x1		3/0–400 kcmil	0.83
	x1		3/0–400 kcmil	0.83

- Câble souple avec embout
- Câble rigide

N° Article	Désignation		kg/lbs
561164	SB400AL	1	0.249 / 0.55

Blocs de jonction de puissance

SB400



SB630AL



SB400
500 A – IEC
335 A –

1 câble – 1 câble

- Icw kA rms 1s: 28.8
- Ipk kA: 51
- Ui: 1000 V AC IEC
- Ui: 1500 V DC IEC
- Vin: 1250 VAC/DC UL

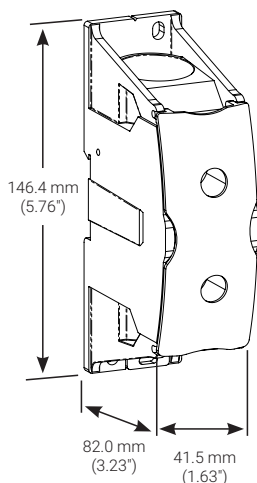

SB630AL
860 A – IEC
545 A –

1 câble – 1 câble

- Icw kA rms 1s: 60
- Ipk kA: 51
- Ui: 1000 VAC IEC
- Ui: 1500 VDC IEC
- Vin: 1250 VAC/DC UL

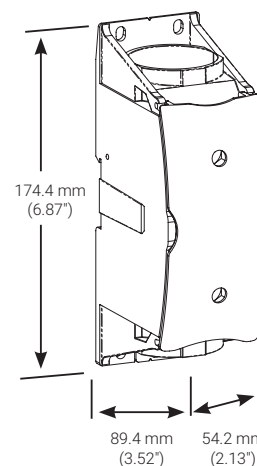

Métrique				
	Nbre de sorties	Conducteurs	Section mm ²	Ø mm
	x1		95–240	21.0
	x1		95–240	21.0

Métrique				
	Nbre de sorties	Conducteurs	Section mm ²	Ø mm
	x1		240–500	31.0
	x1		240–500	31.0

Impérial				
	Nbre de sorties	Conducteurs	Section AWG	Ø in
	x1		3/0–400 kcmil	0.83
	x1		3/0–400 kcmil	0.83

Impérial				
	Nbre de sorties	Conducteurs	Section AWG	Ø in
	x1		400–1000 kcmil	1.22
	x1		400–1000 kcmil	1.22

- Câble souple avec embout
- Câble rigide

- Câble souple avec embout
- Câble rigide

N° Article	Désignation		kg/lbs
561152	SB400	1	0.51/1.13

N° Article	Désignation		kg/lbs
561168	SB630AL	1	0.585 / 1.29

Blocs de jonction de puissance

SB630



SBF630AL



SB630
870 A – IEC
545 A –

1 câble – 1 câble

- Icw kA rms 1s : 60.0
- Ipk kA : 51
- Ui : 1000 V AC IEC
- Ui : 1500 V DC IEC
- Vin: 1250 VAC/DC UL

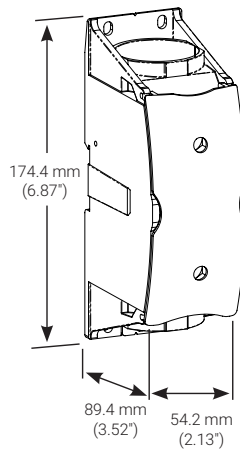

SBF630AL
760 A – IEC (Flexibar Advanced)
750 A – IEC (IBSB Advanced)
490 A – (Flexibar Advanced)
410 A – (IBSB Advanced)

Conducteur plat – 1 câble

- Icw kA rms 1s: 60
- Ipk kA: 51
- Ui: 1000 VAC IEC
- Ui: 1500 VDC IEC
- Vin: 1000 VAC/DC UL

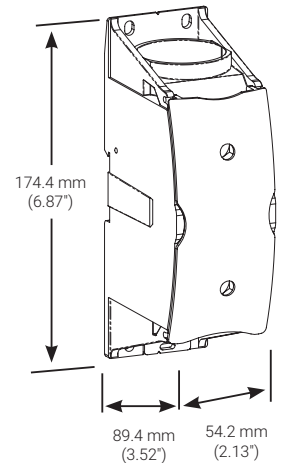

Métrique				
	Nbre de sorties	Conducteurs	Section mm ²	Ø mm
	x1	 	240–500	31.0
	x1	 	240–500	31.0

Métrique				
	Nbre de sorties	Conducteurs	Section mm ²	Ø mm
	x1	Flexibar Advanced IBSB Advanced	2x20x1–8x32x1 100–240	N/A
	x1	 	240–500	31.0

Impérial				
	Nbre de sorties	Conducteurs	Section AWG	Ø in
	x1	 	400–1000 kcmil	1.22
	x1	 	400–1000 kcmil	1.22

Impérial				
	Nbre de sorties	Conducteurs	Section AWG	Ø in
	x1	Flexibar Advanced IBSB Advanced	2x20x1–8x32x1 100–240	N/A
	x1		400–1000 kcmil	1.22

- Câble souple avec embout
- Câble rigide

- Câble souple avec embout
- Câble rigide

N° Article	Désignation		kg/lbs
561156	SB 630	1	1.20/2.64

N° Article	Désignation		kg/lbs
561169	SBF630AL	1	0.64 / 1.41

Blocs de jonction de puissance

SBF630



SBF2C630AL



SBF630
 805 A – IEC
 (Flexibar Advanced)
 800 A – IEC
 (IBSB Advanced)
 545 A –

Conducteur plat – 1 câble

- I_{cw} kA rms 1s : 60.0
- I_{pk} kA : 51
- U_i : 1000 V AC IEC
- U_i : 1500 V DC IEC
- Vin : 1000 VAC/DC UL

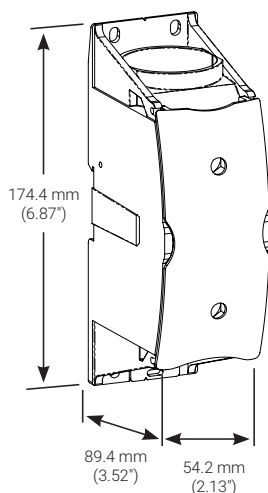

SBF2C630AL
 930 A – IEC
 (Flexibar Advanced)
 910 A – IEC
 (IBSB Advanced)
 760 A –

Conducteur plat – 2 câbles

- I_{cw} kA rms 1s : 60.0
- I_{pk} kA : 52
- U_i : 1000 V AC IEC
- U_i : 1500 VDC IEC
- Vin : 1000 VAC/DC UL

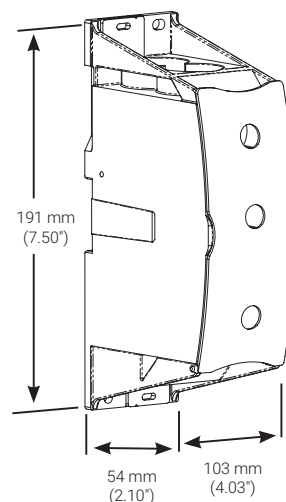

Métrique				
	Nbre de sorties	Conducteurs	Section mm ²	Ø mm
	x1	Flexibar IBS/IBSB	2x20x1–8x32x1 100, 240	N/A
	x1		240–500	31.0

Impérial				
	Nbre de sorties	Conducteurs	Section AWG	Ø in
	x1	Flexibar IBS/IBSB	2x20x1–8x32x1 100–240	N/A
	x1		400–1000 kcmil	1.22

- Câble souple avec embout
- Câble rigide

N° Article	Désignation		kg/lbs
561157	SBF 630	1	1.39/3.07

Métrique				
	Nbre de sorties	Conducteurs	Section mm ²	Ø mm
	x1	Flexibar Advanced IBSB Advanced	240 IBSB/IBSB ADV	N/A
	x2		2x35–240	22

Impérial				
	Nbre de sorties	Conducteurs	Section AWG	Ø in
	x1	Flexibar Advanced IBSB Advanced	2x20x1–8x32x1 Flexibar ADV	N/A
	x2		2x #2–500 kcmil	0.87

- Câble souple avec embout
- Câble rigide

N° Article	Désignation		kg/lbs
561173	SBF2C630AL	1	0.68 / 1.5

Blocs de jonction de puissance

SB2C1000AL



SB2C2C1000AL

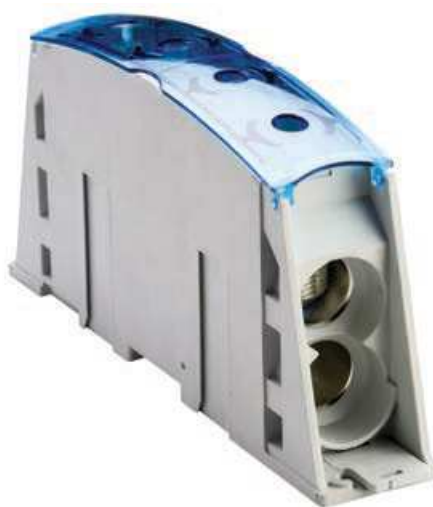

SB2C1000AL
1020 A – IEC
545 A – UL

1 câble – 2 câbles

- Icw kA rms 1s: 72.0
- Ipk kA: 75
- Ui: 1000 VAC IEC
- Ui: 1000 VDC IEC
- Vin: 1000 VAC/DC UL

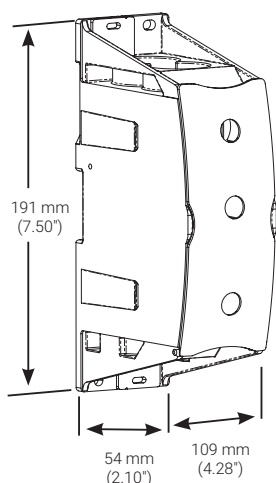

SB2C2C1000AL
1150 A – IEC
840 A – UL

2 câbles – 2 câbles

- Icw kA rms 1s: 72.0
- Ipk kA: 75
- Ui: 1000 VAC IEC
- Ui: 1500 VDC IEC
- Vin: 1000 VAC/DC UL

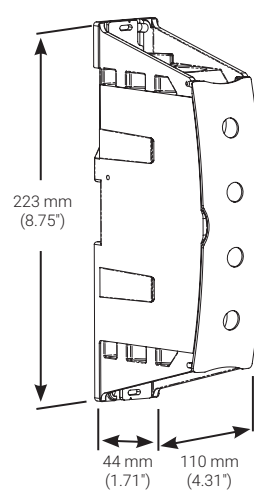

Métrique				
	Nbre de sorties	Conducteurs	Section mm ²	Ø mm
	x1		240–500	31
	x2		2x35–300	23.6

Impérial				
	Nbre de sorties	Conducteurs	Section AWG	Ø in
	x1		400–1000 kcmil	1.22
	x2		2x #2–600 kcmil	0.93

- Câble souple avec embout
- Câble rigide

N° Article	Désignation		kg/lbs
561174	SB2C1000AL	1	0.748 / 1.65

Métrique				
	Nbre de sorties	Conducteurs	Section mm ²	Ø mm
	x2		2x35–300	23.5
	x2		2x35–300	23.5

Impérial				
	Nbre de sorties	Conducteurs	Section AWG	Ø in
	x2		2x #2–600 kcmil	0.92
	x2		2x #2–600 kcmil	0.92

- Câble souple avec embout
- Câble rigide

N° Article	Désignation		kg/lbs
561175	SB2C2C1000AL	1	0.718 / 1.58

Blocs de jonction de puissance

SBF3C1000AL



SBF4C1600AL



SBF3C1000AL
1420 A - IEC
1260 A -

Conducteur plat - 3 câbles

- Icw kA rms 1s: 72.0
- Ipk kA: 75
- Ui: 1000 VAC IEC
- Ui: 1500 VDC IEC
- Vin: 1000 VAC/DC UL

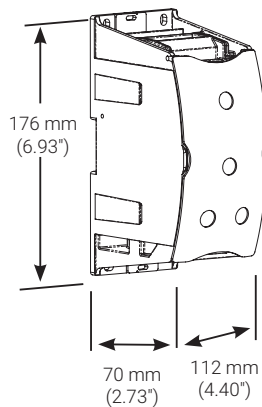

SBF4C1600AL
1940 A - IEC
1680 A -

Conducteur plat - 4 câbles

- Icw kA rms 1s: 96.0
- Ipk kA: 105
- Ui: 1000 VAC IEC
- Ui: 1500 VDC IEC
- Vin: 1000 VAC/DC UL

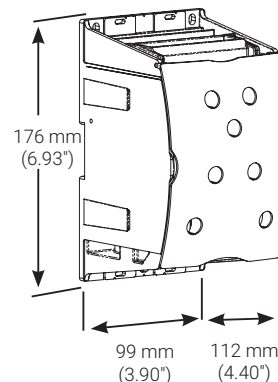

Métrique				
	Nbre de sorties	Conducteurs	Section mm ²	Ø mm
	x1	Flexibar Advanced	2x20x1-10x50x1	N/A
	x3		3x35-300	23.5

Impérial				
	Nbre de sorties	Conducteurs	Section AWG	Ø in
	x1	Flexibar Advanced	2x20x1-10x50x1	N/A
	x3		3x #2-600 kcmil	0.92

- Câble souple avec embout
- Câble rigide

N° Article	Désignation		kg/lbs
561176	SBF3C1000AL	1	0.952 / 2.1

Métrique				
	Nbre de sorties	Conducteurs	Section mm ²	Ø mm
	x1	Flexibar Advanced	6x50x1-10x80x1	
	x4		4x35-300	23.5

Impérial				
	Nbre de sorties	Conducteurs	Section AWG	Ø in
	x1	Flexibar Advanced	6x50x1-10x80x1	
	x4		4x #2-600 kcmil	0.92

- Câble souple avec embout
- Câble rigide

N° Article	Désignation		kg/lbs
561177	SBF4C1600AL	1	1.292 / 2.85

Bornes – SBLL, SBTT, SBLT

CARACTÉRISTIQUES PRINCIPALES

BORNIERES DE PUISSANCE – SBLT

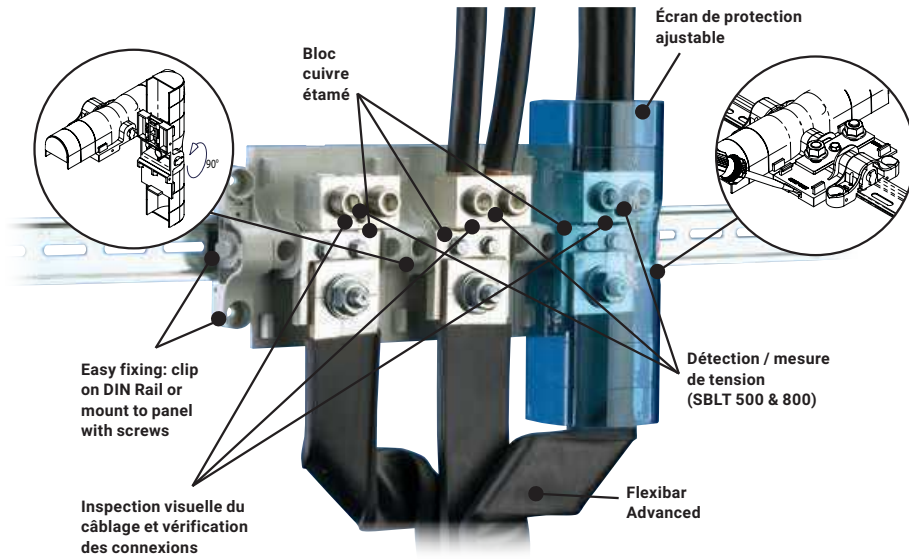

BORNIERES DE PUISSANCE – SBLL

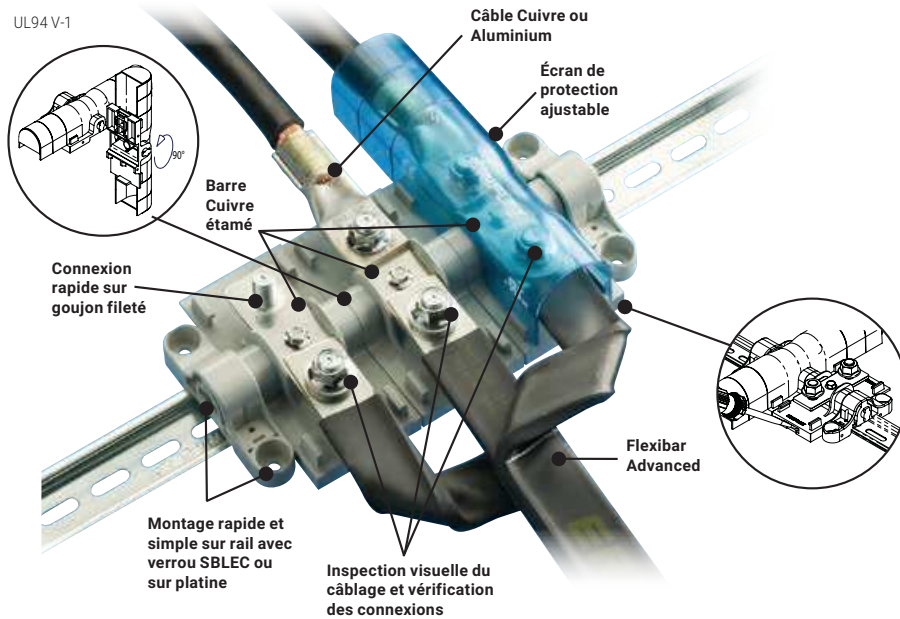

- Testé et certifié suivant CEI 60947-7-1 $U_i=1000$ V AC / 1500 V DC
- Certifié UL® pour USA & Canada
- UL 1059
- CSA Certified
- Valeur de court-circuit jusqu'à 100 KA (voir dossier UL N° E 198301)
- Sans Halogène
- UL94 V-1
- Conformité RoHS
- Conformité CE
- Conformité EAC

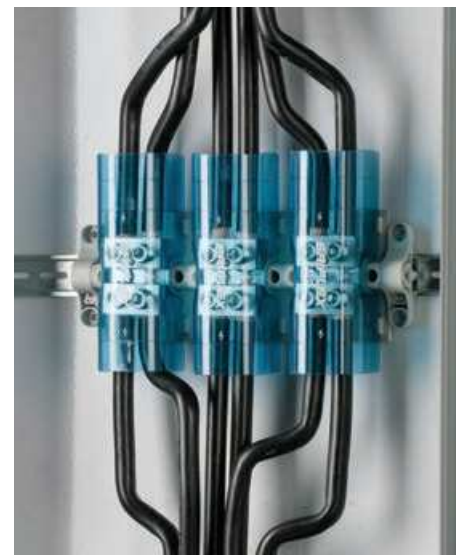



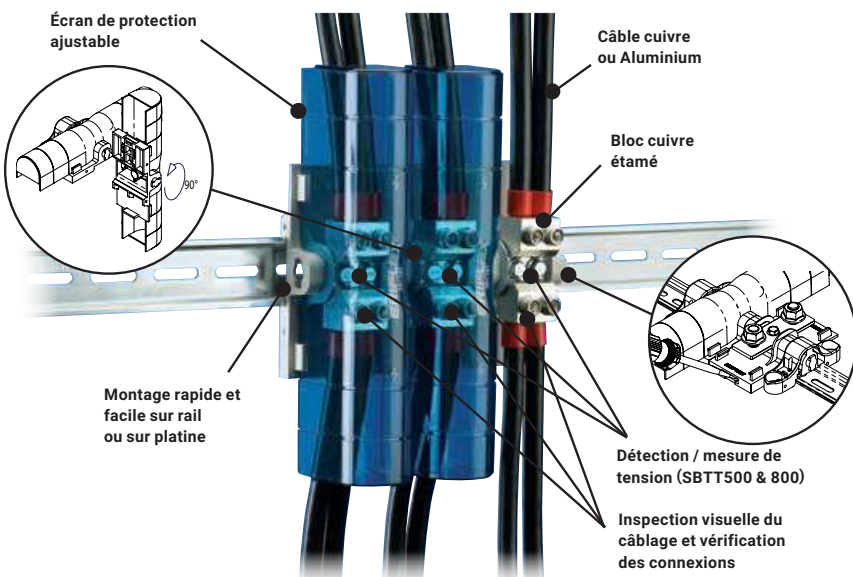



















BORNIERES DE PUISSANCE – SBTT



Borniers de puissance – guide de sélection rapide

GUIDE DE SÉLECTION RAPIDE – BORNERS DE PUISSANCE (SBLL, SBTT, SBLT)

Référence	N° Article	Max IEC Intensité	Max UL Intensité	Côté ligne : Nbre de connexion		Côté ligne Min et Max taille du conducteur	Côté charge : Nbre de connexion		Côté charge Min et Max taille du conducteur	Max voltage IEC	Max voltage UL
SBLL-250	561132	290 A	255 A		Conducteur plat	Flexibar 2x20x1-5x24x1 Lug + Câble 10-120 mm ² #8-250 kcmil		Conducteur plat	Flexibar 2x20x1-5x24x1 Lug + Câble 10-120 mm ² #8-250 kcmil	1,000 VAC, 1,500 VDC	1,000 VAC/DC
SBLL-500	561134	750 A	475 A		Conducteur plat	Flexibar 2x20x1-10x50x1 Lug + Câble 16-400 mm ² #6-700 kcmil		Conducteur plat	Flexibar 2x20x1-10x50x1 Lug + Câble 16-400 mm ² #6-700 kcmil	1,000 VAC, 1,500 VDC	1,000 VAC/DC
SBLL-800	561136	1250 A	800 A		Conducteur plat	Flexibar 2x20x1-8x80x1 (2) Lug + Câble 25-300 mm ² (2) #4-500 kcmil		Conducteur plat	Flexibar 2x20x1-8x80x1 (2) Lug + Câble 25-300 mm ² (2) #4-500 kcmil	1,000 VAC, 1,500 VDC	1,000 VAC/DC
SBLT-250	561140	350 A	300 A		Conducteur plat	Flexibar 2x20x1-5x24x1 Lug + Câble 10-120 mm ² #6-250 kcmil		2 Câbles	(2) 10-50 mm ² (2) #8-1/0	1,000 VAC, 1,500 VDC	1,000 VAC/DC
SBTT-250	561141	350 A	300 A		2 Câbles	(2) 10-50 mm ² (2) #8-1/0		2 Câbles	(2) 10-50 mm ² (2) #8-1/0	1,000 VAC, 1,500 VDC	1,000 VAC/DC
SBLT-350	561142	500 A	310 A		Conducteur plat	Flexibar 2x20x1-8x24x1 Lug + Câble 10-185 mm ² #2-350 kcmil		1 Câble	35-185 mm ² #2-350 kcmil	1,000 VAC, 1,500 VDC	1,000 VAC/DC
SBTT-350	561143	500 A	310 A		1 Câble	35-185 mm ² #2-350 kcmil		1 Câble	35-185 mm ² #2-350 kcmil	1,000 VAC, 1,500 VDC	1,000 VAC/DC
SBLT-500	561144	750 A	500 A		Conducteur plat	Flexibar 2x20x1-10x50x1 Lug + Câble 95-400 mm ² #6-700 kcmil		2 Câbles	(2) 16-120 mm ² (2) #6-250 kcmil	1,000 VAC, 1,500 VDC	1,000 VAC/DC
SBTT-500	561145	750 A	500 A		2 Câbles	(2) 16-120 mm ² (2) #6-250 kcmil		2 Câbles	(2) 16-120 mm ² (2) #6-250 kcmil	1,000 VAC, 1,500 VDC	1,000 VAC/DC
SBLT-800	561146	1250 A	760 A		Conducteur plat	Flexibar 2x20x1-8x80x1 (2) Lug + Câble 35-300 mm ² (2) #1-500 kcmil		2 Câbles	(2) 95-240 mm ² (2) 3/0-500 kcmil	1,000 VAC, 1,500 VDC	1,000 VAC/DC
SBTT-800	561147	1250 A	760 A		2 Câbles	(2) 95-240 mm ² (2) 3/0-500 kcmil		2 Câbles	(2) 95-240 mm ² (2) 3/0-500 kcmil	1,000 VAC, 1,500 VDC	1,000 VAC/DC

Borniers de puissance – SBLL



- Barre Cuivre étamé
- Inspection visuelle du câblage et vérification des connexions
- Connexion des Conducteurs Plats, rapide sur goujon fileté
- Écran de protection ajustable
- Sans Halogène
- Auto Extinguible UL94 V-1
- Montage rapide et facile sur rail ou sur platine avec l'accessoire SBLEC*
- Valeur de court-circuit jusqu'à 100 kA (voir dossier UL N° E 198301)
- Conformité RoHS
- IEC 60947-7-1
- UL 1059

SBLL 250 290 A – IEC 255 A – cULus

- Modulaire: les modules unipolaires sont associables pour des utilisations multipolaires
- Accessoire SBLEC nécessaire pour montage sur platine

- Icw kA rms 1s: 14.4
- Ipk kA: 42
- Ui: 1000 VAC/1500 VDC IEC
- Vin: 1000 VAC/DC UL

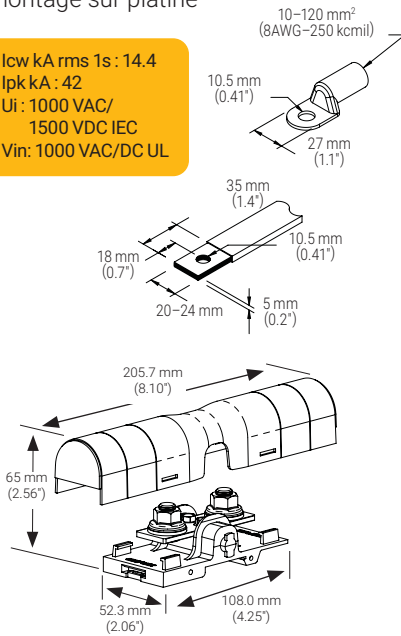

SBLL 500 750 A – IEC 475 A – cULus

- Modulaire: les modules unipolaires sont associables pour des utilisations multipolaires

- Icw kA rms 1s: 36
- Ipk kA: 51
- Ui: 1000 VAC/1500 VDC IEC
- Vin: 1000 VAC/DC UL

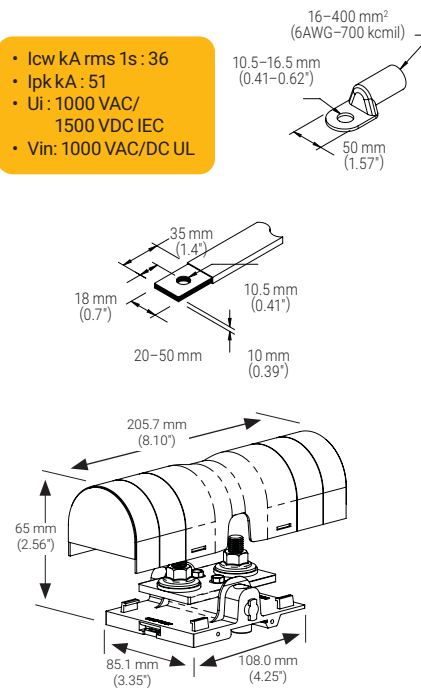

SBLL 800 1250 A – IEC 800 A – cULus

- Modulaire: les modules unipolaires sont associables pour des utilisations multipolaires

- Icw kA rms 1s: 57.6
- Ipk kA: 75
- Ui: 1000 VAC/1500 VDC IEC
- Vin: 1000 VAC/DC UL

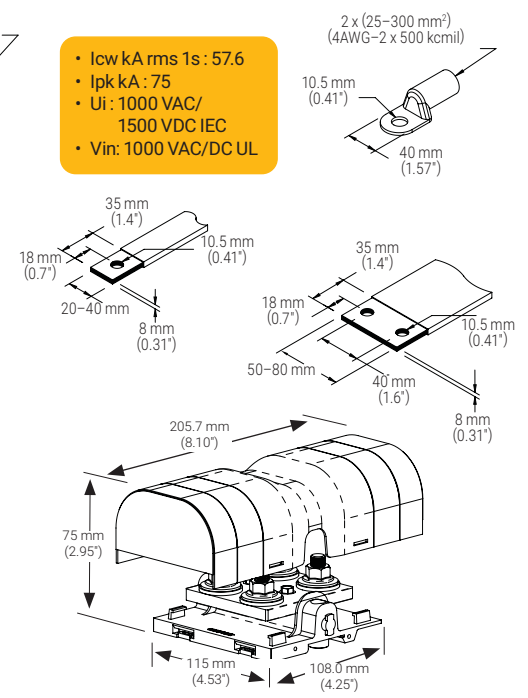

N° Article	Désignation	kg/lbs
561132	SBLL 250	0.16/0.35

N° Article	Désignation	kg/lbs
561134	SBLL 500	0.34/0.75

N° Article	Désignation	kg/lbs
561136	SBLL 800	0.7/1.54

SBLEC

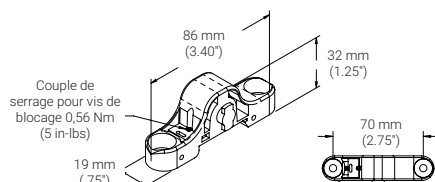

N° Article	Désignation	kg/lbs
561138	SBLEC	0.01/0.02

Borniers de puissance – SBLT

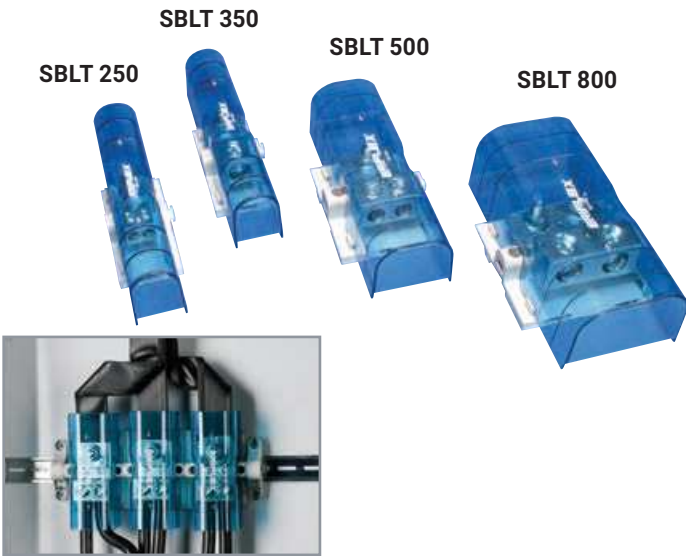

- Bloc cuivre étamé: câbles cuivre ou aluminium
- Inspection visuelle du câblage et vérification des connexions
- Connexion rapide sur goujon fileté ou serre-fils
- Connexion câbles, barres ou Flexibar
- Écran de protection ajustable
- Sans Halogène
- Auto Extinguible UL94 V-1
- Montage rapide et facile sur rail ou sur platine avec l'accessoire SBLEC *
- Valeur de court-circuit jusqu'à 100 KA (voir dossier UL N° E 198301)
- Conformité RoHS

SBLT 250 350 A – IEC 300 A –

- Modulaire: les modules unipolaires sont associables pour des utilisations multipolaires
- Accessoire SBLEC nécessaire pour montage sur platine

- Icw kA rms 1s : 8.4
- Ipk kA : 30
- Ui : 1000 VAC / 1500 VDC IEC
- Vin : 1000 V AC/DC UL

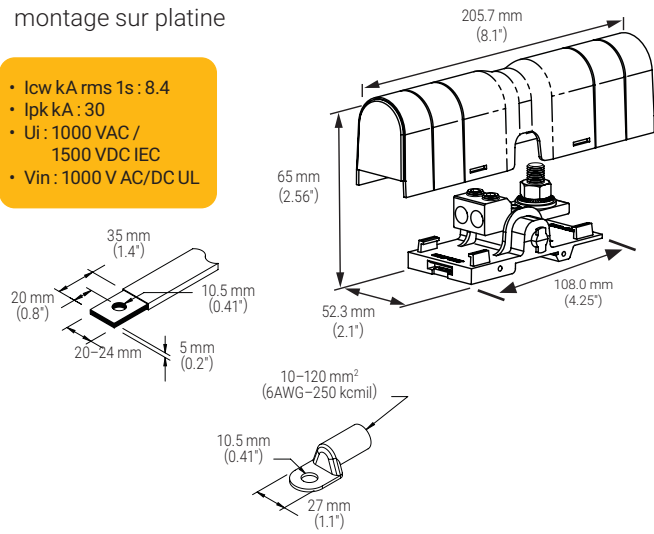

Métrique	mm ²	mm ²		Ø mm
	Flexibar ou câble avec cosse			
	10-50	10-35	x2	10

Impérial	AWG			Ø in
	Flexibar ou câble avec cosse			
	8-1/0	x2		0.394

N° Article	Désignation		kg/lbs
561140	SBLT 250	1	0.27 / 0.60

- Câble souple avec embout
- Câble rigide

SBLT 350 500 A – IEC 310 A –

- Modulaire: les modules unipolaires sont associables pour des utilisations multipolaires
- Accessoire SBLEC nécessaire pour montage sur platine

- Icw kA rms 1s : 22.2
- Ipk kA : 43
- Ui : 1000 VAC / 1500 VDC IEC
- Vin : 1000 V AC/DC UL

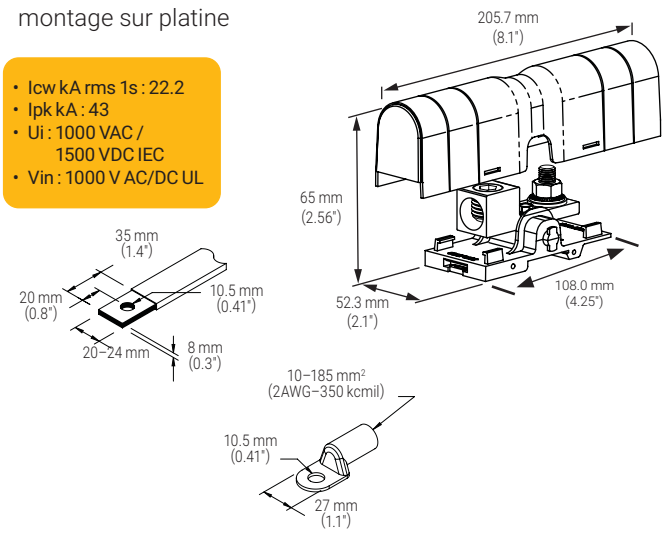

Métrique	mm ²	mm ²		Ø mm
	Flexibar ou câble avec cosse			
	35-185	35-150	x1	20

Impérial	AWG			Ø in
	Flexibar ou câble avec cosse			
	2-350	x1		0.787

N° Article	Désignation		kg/lbs
561142	SBLT 350	1	0.35 / 0.77

Borniers de puissance

SBLT 500
750 A – IEC
500 A – c  

• Modulaire: les modules unipolaires sont associables pour des utilisations multipolaires

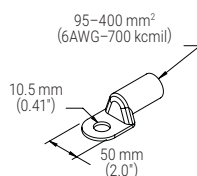
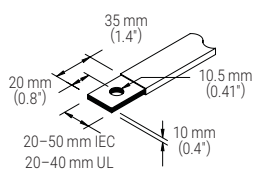
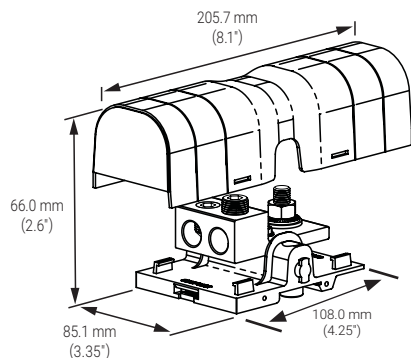

- Icw kA rms 1s : 28.8
- Ipk kA : 52
- Ui : 1000 VAC / 1500 VDC IEC
- Vin : 1000 V AC/DC UL



Métrique	 mm ²	 mm ²	Ø mm	
 	Flexibar ou câble avec cosse			
	16-120	16-120	x2	15

Impérial	AWG	Ø in	
 	Flexibar ou câble avec cosse		
	6-250	x2	0.59

N° Article	Désignation		 kg/lbs
561144	SBLT 500	1	0.61 / 1.34

-  Câble souple avec embout
-  Câble rigide



SBLT 800
1250 A – IEC
760 A – c  

• Modulaire: les modules unipolaires sont associables pour des utilisations multipolaires

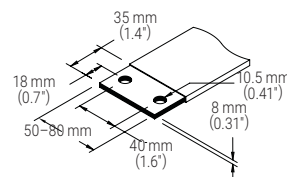
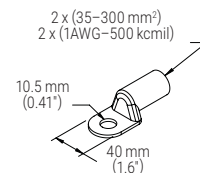
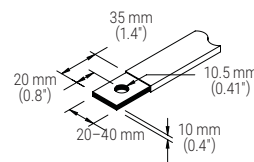
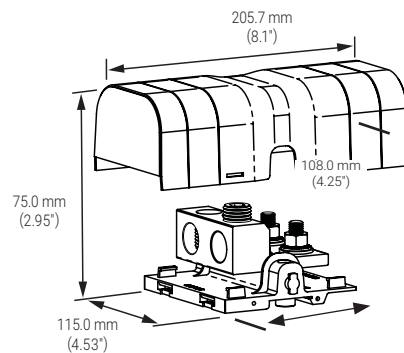
- Icw kA rms 1s : 57.6
- Ipk kA : 75
- Ui : 1000 VAC / 1500 VDC IEC
- Vin : 1000 V AC/DC UL





Métrique	 mm ²	 mm ²	Ø mm	
 	Flexibar ou câble avec cosse			
	95-240	50-185	x2	22

Impérial	AWG	Ø in	
 	Flexibar ou câble avec cosse		
	3/0-500	x2	0.866

N° Article	Désignation		 kg/lbs
561146	SBLT 800	1	1.09 / 2.40

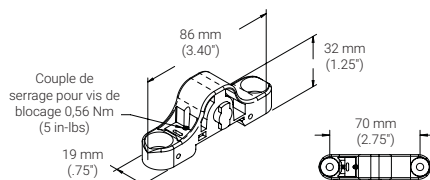
SBLEC



N° Article	Désignation		 kg/lbs
561138	SBLEC	1	0.01/0.02

Borniers de puissance – SBTT

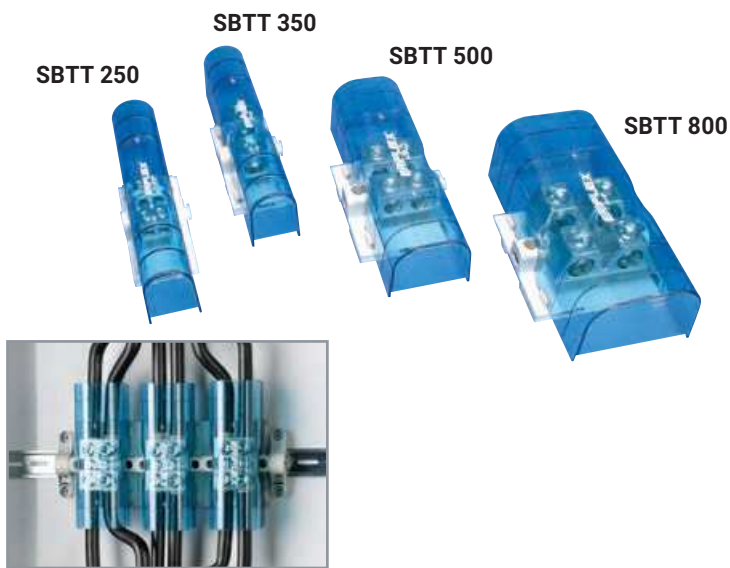

SBTT 250
350 A – IEC
300 A –

- Modulaire: les modules unipolaires sont associables pour des utilisations multipolaires
- Accessoire SBLEC nécessaire pour montage sur platine

• Icw kA rms 1s : 8.4
• Ipk kA : 30
• Ui : 1000 VAC / 1500 VDC IEC
• Vin : 1000 V AC/DC UL

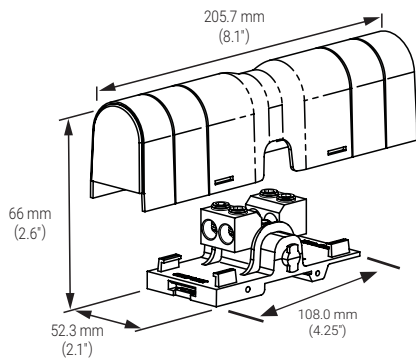

Métrique	mm ²	mm ²		Ø mm
	10–50	10–35	x4	10

Impérial	AWG			Ø in
	8–1/0	x4		0.394

N° Article	Désignation		kg/lbs
561141	SBTT 250	1	0.26 / 0.57

Câble souple avec embout
 Câble rigide

- Bloc cuivre étamé: câbles cuivre ou aluminium
- Inspection visuelle du câblage et vérification des connexions
- Connexion sur câbles
- Écran de protection ajustable
- Sans Halogène
- Auto Extinguible UL94 V-1
- Montage rapide et facile sur rail ou sur platine avec l'accessoire SBLEC *
- Valeur de court-circuit jusqu'à 100 KA (voir dossier UL N° E 198301)
- Conformité RoHS

SBTT 350
500 A – IEC
310 A –

- Modulaire: les modules unipolaires sont associables pour des utilisations multipolaires
- Accessoire SBLEC nécessaire pour montage sur platine

• Icw kA rms 1s : 22.2
• Ipk kA : 43
• Ui : 1000 VAC / 1500 VDC IEC
• Vin : 1000 V AC/DC UL

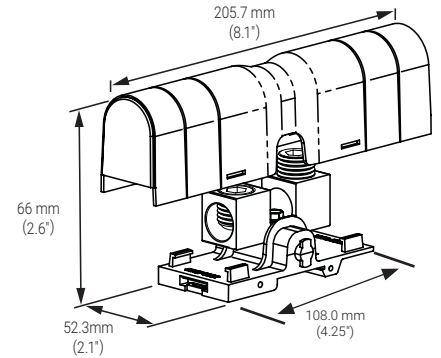

Métrique	mm ²	mm ²		Ø mm
	35–185	35–150	x2	20

Impérial	AWG			Ø in
	2–350	x2		0.787

N° Article	Désignation		kg/lbs
561143	SBTT 350	1	0.33 / 0.73

Blocs de jonction de puissance & borniers de puissance

SBTT 500
 750 A – IEC
 500 A –  

• Modulaire: les modules unipolaires sont associables pour des utilisations multipolaires

- Icw kA rms 1s : 28.8
- Ipk kA : 52
- Ui : 1000 VAC / 1500 VDC IEC
- Vin : 1000 V AC/DC UL

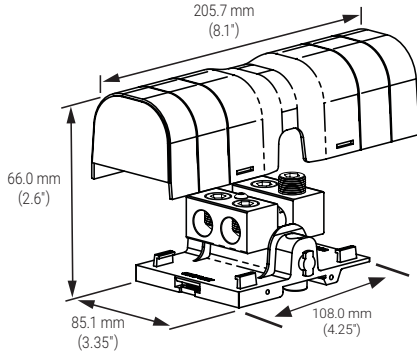







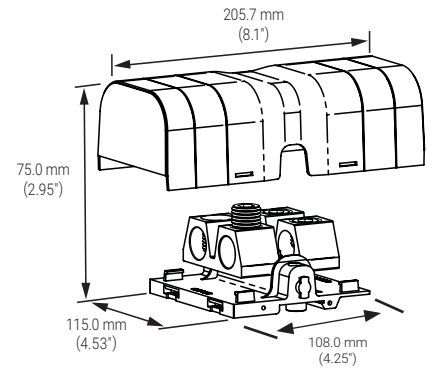

SBTT 800
 1250 A – IEC
 760 A –  

• Modulaire: les modules unipolaires sont associables pour des utilisations multipolaires

- Icw kA rms 1s : 57.6
- Ipk kA : 75
- Ui : 1000 VAC / 1500 VDC IEC
- Vin : 1000 V AC/DC UL



Métrique	 mm ²	 mm ²		Ø mm
 	16-120	16-120	x4	15



Métrique	 mm ²	 mm ²		Ø mm
 	95-240	50-185	x4	22

Impérial	AWG		Ø in
 	6-250	x4	0.59

Impérial	AWG		Ø in
 	3/0-500	x4	0.866

N° Article	Désignation		 kg/lbs
561145	SBTT 500	1	0.60 / 1.32

N° Article	Désignation		 kg/lbs
561147	SBTT 800	1	1.04 / 2.29

-  Câble souple avec embout
-  Câble rigide

SBLEC

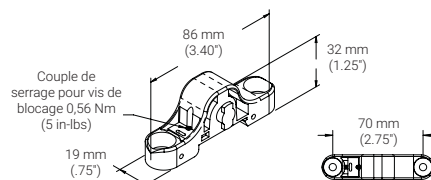

N° Article	Désignation		 kg/lbs
561138	SBLEC	1	0.01/0.02

Répartiteurs tétrapolaires

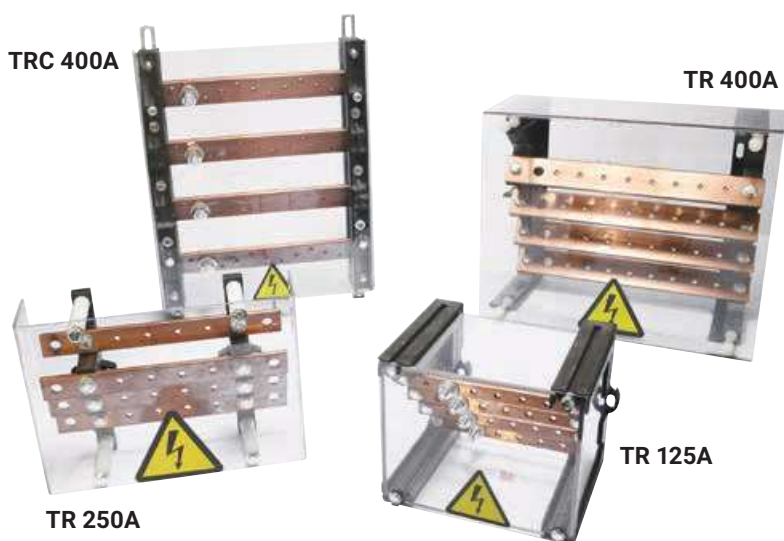

- Gamme de 125 à 630 A
- Écran de protection
- Grande accessibilité pour le câblage
- Pré-monté
- Auto extinguable UL 94V-0
- Conformité RoHS
- IEC 61439.1

TR 125A

Barres taraudées
12 x 4 - I = 125 A

- Montage rapide et facile sur rail DIN ou sur platine
- Écran de protection sur 5 faces
- Arrivée: 1 goujon serti M6
- 5 départs / phase M5

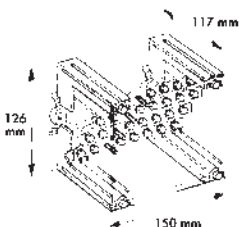

- Icw kA rms 1s: 8,4
- Ipk kA: 40
- Ui = 1000V

TR 250A

Barres taraudées
20 x 5 - I = 250 A

- Montage rapide et facile sur rail DIN asymétrique ou sur platine
- Arrivées: droite ou gauche Ø 8 mm
- 4 départs / phase M6

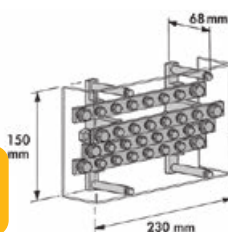

- Icw kA rms 1s: 17
- Ipk kA: 34
- Ui = 630V

TRC 400A

Barres taraudées
32 x 5 - I = 400 A

- Facilité de câblage: barres inclinées
- Arrivée: 1 goujon serti M10
- 10 départs / phase M6



- Icw kA rms 1s: 28
- Ipk kA: 118
- Ui = 1000V

N° Article	Désignation		
563150	TR 125A	1	0.684

N° Article	Désignation		
563170	TR 250A	1	1.30

N° Article	Désignation		
563180	TRC 400A	1	2.65

TRS 160A

Barres taraudées
15 x 5 - I = 160 A

- Montage rapide et facile sur rail DIN asymétrique ou sur platine
- Arrivées: droite ou gauche Ø 8 mm
- 6 départs / phase M6

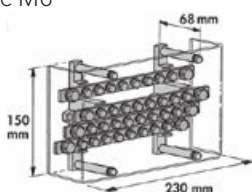

- Icw kA rms 1s: 13,2
- Ipk kA: 34
- Ui = 630V

TR 400A

Barres taraudées
32 x 5 - I = 400 A

- Montage rapide et facile sur rail DIN asymétrique ou sur platine
- 1 arrivée Ø 10 mm
- 8 départs / phase M6

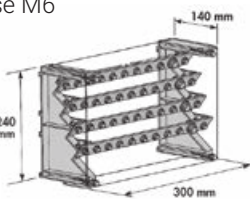

- Icw kA rms 1s: 28
- Ipk kA: 34
- Ui = 1000V

TRC 630A

Barres taraudées
30 x 10 - I = 630 A

- 1 arrivée Ø 10 mm
- 8 départs / phase M8

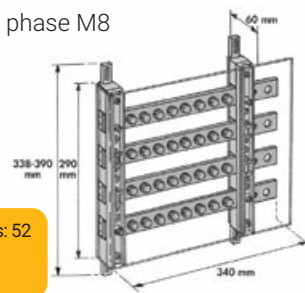

- Icw kA rms 1s: 52
- Ipk kA: 84
- Ui = 1000V

N° Article	Désignation		
563160	TRS 160A	1	1.15

N° Article	Désignation		
562010	TR 400A	1	2.83

N° Article	Désignation		
563190	TRC 630A	1	4.80

Répartiteurs tétrapolaires



Répartiteurs étagés tétrapolaires à composer

- Polyamide renforcé par fibre de verre
- Auto extinguable UL 94V-0
- Fixation d'écran de protection (voir page 50)
- Montage rapide et facile sur rail DIN ou sur platine
- Conformité RoHS
- Sans Halogène
- IEC 61439.1

BS/BSC 125A

125A – 160A

Pour barres taraudées 12 x 4 et 15 x 5

- Facilité de connexion
 - Fixation sur platine par vis M6 ou sur rail DIN à l'aide du clip DR (art. N° 563100)
 - Sans Halogène
- 1) Vis de pression pour bloquer le support sur le rail DIN
 - 2) Fixation directe de l'écran avec vis auto-taraudeuses
 - 3) Fixation sur platine

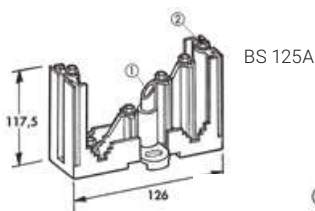

- BS 125A $U_i = 1000\text{ V}$
- BSC 125A $U_i = 630\text{ V}$

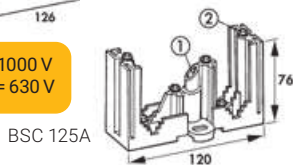

BS 250A

160A – 250A

Pour barres taraudées M6 15 x 5 et 20 x 5

- Encombrement réduit
- Fixation des barres par vis M6
- Montage possible d'un écran de protection par adjonction d'entretoises
- Sans Halogène

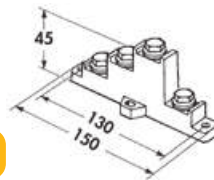

• $U_i = 630\text{ V}$

BS 400A

160A – 630A

Pour barres taraudées 15 x 5 – 20 x 5 – 32 x 5 – 20 x 10 – 30 x 10

- Montage rapide et facile sur rail DIN ou sur platine
- Montage possible d'un écran de protection réglable en hauteur
- Sans Halogène

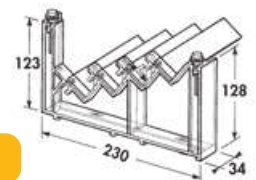

• $U_i = 1000\text{ V}$

N° Article	Désignation		
551300	BS 250A	10	0.050

N° Article	Désignation		
551250	BS 400A	2	0.220

N° Article	Désignation		
551311	BS-B 125A	10	0.100
551321	BSC-B 125A	10	0.100

Voir notre cahier technique pour le calcul de l'espace entre supports en fonction de l'icc

Écran transparent page 50

Système déconnectable PEN

UNE SOLUTION UNIQUE POUR RÉSEAUX TN-C TN-S

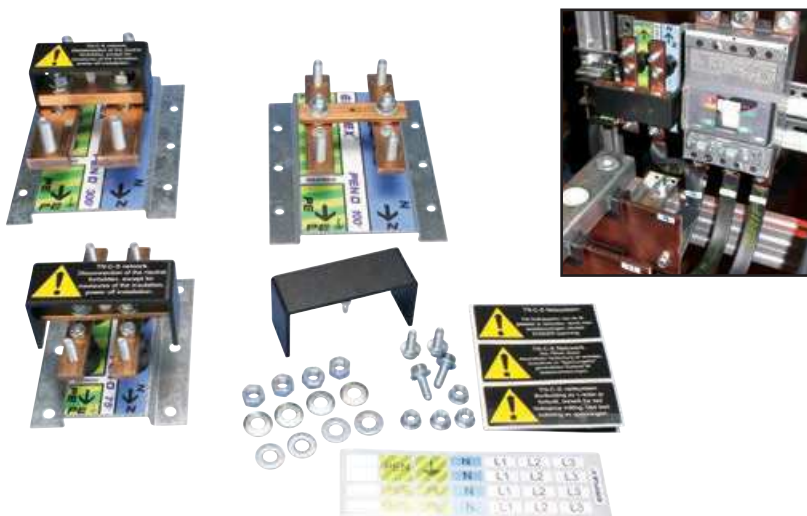

- Application: Produit spécifique permettant la séparation PEN et PE+N
- Système avec barrette de déconnexion sécurisé
- Identification des circuits
- Évite les erreurs de mesure
- Évite les erreurs de connexion
- Répond aux exigences des bureaux de contrôle
- Instructions de sécurité incluses
- CE

PEN-D 75²
I_n : 125A max

PEN-D 100²
I_n : 250A max

PEN-D 300²
I_n : 630A max

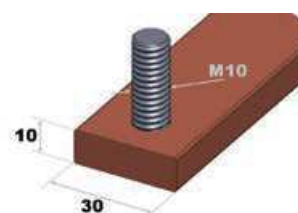
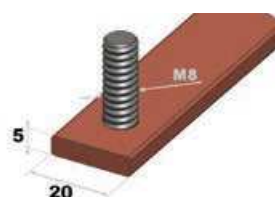
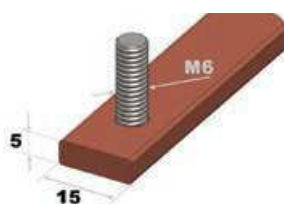
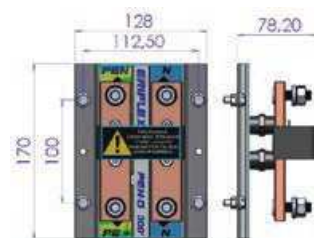
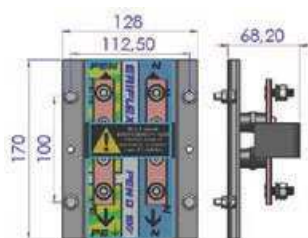
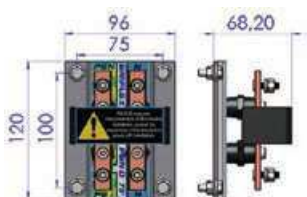

N° Article	Désignation		kg/lbs
568800	PEN-D 75 ²	1	0.55/1.21

N° Article	Désignation		kg/lbs
568805	PEN-D 100 ²	1	0.80/1.76

N° Article	Désignation		kg/lbs
568810	PEN-D 300 ²	1	1.52/3.35

PEN-D SCHÉMA DE CÂBLAGE POUR ARMOIRES DIVISIONNAIRES

Distribution TN-S

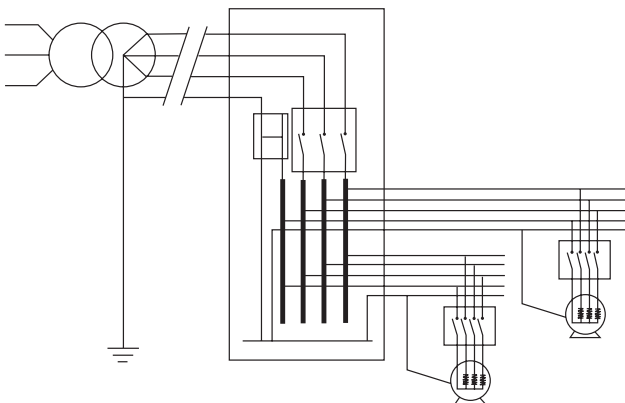

Alimentation dédiée TN-S

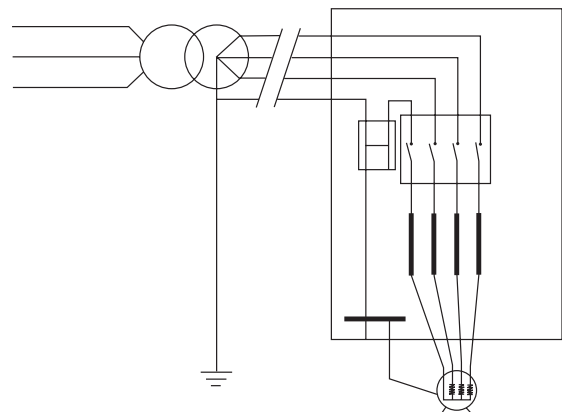

Accessoires



• Une gamme complète pour faciliter le montage des répartiteurs



DMH M4/M5/M6

Entretoises métalliques

- Entretoises métalliques hexagonales
- Acier zingué
- Pour surélever les platines, écrans ou profils
- Fixation stable mâle-femelle
- Voir schéma DH

N° Article	Désignation	L mm	Ø mm	A mm	B mm		
561560	DMH 10M4	10	M4	8-10	7	100	0.003
561570	DMH 15M4	15	M4	8-10	7	100	0.005
561580	DMH 20M4	20	M4	8-10	7	100	0.007
561590	DMH 25M4	25	M4	8-10	7	50	0.008
561600	DMH 30M4	30	M4	8-10	7	50	0.010
561610	DMH 35M4	35	M4	8-10	7	50	0.012
561620	DMH 40M4	40	M4	8-10	7	50	0.0125
561630	DMH 50M4	50	M4	8-10	7	50	0.017
561640	DMH 60M4	60	M4	8-10	7	25	0.019

561660	DMH 15M5	15	M5	10	8	50	0.006
561670	DMH 20M5	20	M5	10	8	50	0.008
561680	DMH 25M5	25	M5	10	8	50	0.010
561690	DMH 30M5	30	M5	10	8	50	0.012
561700	DMH 35M5	35	M5	10	8	25	0.014
561710	DMH 40M5	40	M5	10	8	25	0.016
561720	DMH 50M5	50	M5	10	8	25	0.022
561730	DMH 60M5	60	M5	10	8	25	0.027
561740	DMH 70M5	70	M5	10	8	25	0.029
561750	DMH 80M5	80	M5	10	8	25	0.033

561760	DMH 15M6	15	M6	10	10	50	0.010
561770	DMH 20M6	20	M6	12	10	50	0.012
561780	DMH 30M6	30	M6	12	10	25	0.018
561790	DMH 40M6	40	M6	12	10	25	0.025
561800	DMH 50M6	50	M6	12	10	25	0.032
561810	DMH 60M6	60	M6	12	10	25	0.038
561820	DMH 70M6	70	M6	12	10	25	0.043
561830	DMH 80M6	80	M6	12	10	25	0.052
561840	DMH 90M6	90	M6	12	10	25	0.058
561850	DMH 100M6	100	M6	12	10	10	0.064

DH M5/M6

Entretoises isolantes hexagonales

- Mâle-femelle
- Pour applications électrotechniques
- Isolant en polystyrol
- Embout mâle en acier zingué
- Temp. maxi de fonctionnement: 80°C
- Tension d'isolement 1000 V

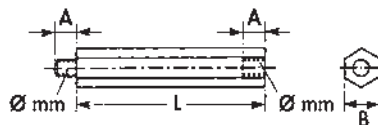

N° Article	Désignation	L mm	Ø mm	A mm	B mm		
560660	DH 15M5	15	M5	7	13	100	0.004
560670	DH 20M5	20	M5	7	13	100	0.005
560600	DH 30M5	30	M5	7	13	100	0.006
560610	DH 45M5	45	M5	7	13	100	0.009
560620	DH 55M5	55	M5	7	13	100	0.011
560630	DH 70M5	70	M5	7	13	100	0.014
560640	DH 85M5	85	M5	7	13	100	0.017
560650	DH 120M5	120	M5	7	13	100	0.024

560740	DH 15M6	15	M6	7-8	13	100	0.004
560750	DH 20M6	20	M6	7-8	13	100	0.005
560700	DH 30M6	30	M6	7-8	13	100	0.009
560710	DH 45M6	45	M6	7-8	13	100	0.013
560720	DH 70M6	70	M6	7-8	13	100	0.020
560730	DH 120M6	120	M6	7-8	13	100	0.035

CAPN-CAPB

Capuchons

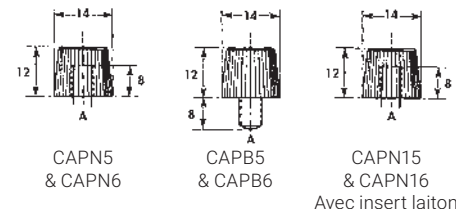

N° Article	Désignation	A		
560800	CAPN5	M5	100	0.001
560810	CAPN6	M6	100	0.001
560820	CAPN15	M5	100	0.003
560830	CAPN16	M6	100	0.003
560840	CAPB5	M5	100	0.004
560850	CAPB6	M6	100	0.004

PS

Écran de protection (PVC)

- U_i = 1000 V

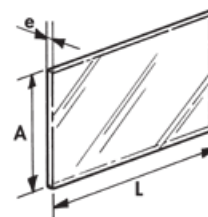

N° Article	Désignation	L mm	Ø mm	A mm	Montage sur		
563120	PS1000x60x3	1000	60	3	BSC 125A/S	10	0.302
551330	PS500x126x3	500	126	3	BS 125A/T	10	0.224
551260	PS1000x250x3	1000	250	3	BS 400/T	1	1.030
551280	PS1000x2000x3	1000	2000	3	-	1	8.4

Rails DIN

PROFIL PERFORÉ ASYMÉTRIQUE PDRG

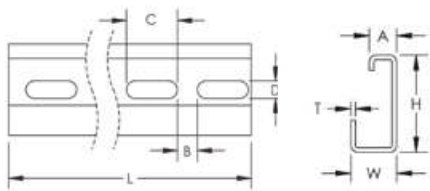

Référence	N° Article	Hauteur H mm	Largeur W mm	Longueur L mm	Épaisseur T mm	A mm	B mm	C mm	D mm	kg
PDRG-2M	558050	32	15	2,000	1.5	9	7	18	6.2	1.30
PDRG-3M	558060	32	15	3,000	1.5	9	7	18	6.2	1.96

PROFIL ASYMÉTRIQUE DRG

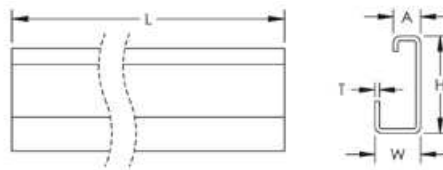

Référence	N° Article	Hauteur H mm	Largeur W mm	Longueur L mm	Épaisseur T mm	A mm	kg
DRG2M	558000	32	15	2,000	1.5	9	1.4
DRG3M	558010	32	15	3,000	1.5	9	2.1

PROFIL PERFORÉ SYMÉTRIQUE PDR

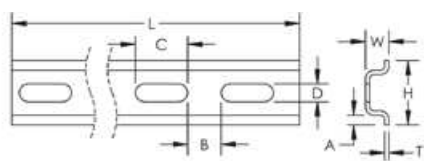

Référence	N° Article	Hauteur H mm	Largeur W mm	Longueur L mm	Épaisseur T mm	A mm	B mm	C mm	D mm	kg
PDR15-2M	557950	35	15.0	2,000	1.5	4.00	7.0	18.0	6.2	1.20
PDR15-3M	557960	35	15.0	3,000	1.5	4.00	7.0	18.0	6.2	1.81
PDR5-2M	557750	15	5.5	2,000	1.0	2.25	7.8	12.2	4.2	0.28
PDR7-2M	557850	35	7.5	2,000	1.0	4.00	7.0	18.0	6.2	0.62
PDR7-2M-5-2	557855	35	7.5	2,000	1.0	4.00	11.0	25.0	5.2	0.62
PDR7-3M	557860	35	7.5	3,000	1.0	4.00	7.0	18.0	6.2	0.92

PROFIL SYMÉTRIQUE DR

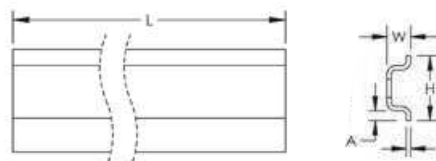

Référence	N° Article	Hauteur H mm	Largeur W mm	Longueur L mm	Épaisseur T mm	A mm	kg
DR15X2M	557900	35	15.0	2,000	1.5	4.00	1.30
DR15X3M	557910	35	15.0	3,000	1.5	4.00	1.95
DR5-5X2M	557700	15	5.5	2,000	1.0	2.25	0.33
DR7X2M	557800	35	7.5	2,000	1.0	4.00	0.66
DR7X3M	557810	35	7.5	3,000	1.0	4.00	0.99

PROFIL PCR PERFORÉ EN FORME DE C

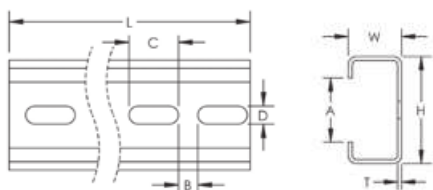

Référence	N° Article	Hauteur H mm	Largeur W mm	Longueur L mm	Épaisseur T mm	A mm	B mm	C mm	D mm	kg
PCR30X15-3M	557780	30	15	3,000	1.5	15	7	18	8.2	2.4
PCR35X35-2M	557520	35	35	2,000	2.0	16	7	18	8.2	3.0
PCR35X35-3M	557790	35	35	3,000	2.0	16	7	18	8.2	4.5
PCR40X20-2M	557500	40	20	2,000	1.5	24	7	18	8.2	2.5



Accessoires de rail DIN

ÉCROU DE COLLIER DR-CLIP POUR RAIL DIN SYMÉTRIQUE

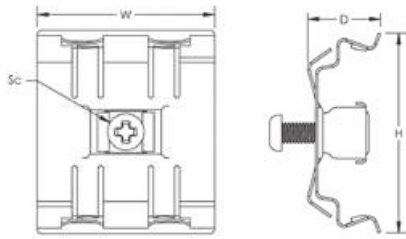

Référence	N° Article	Diamètre de la vis Sc	Largeur W mm	Hauteur H mm	Profondeur D mm	kg
DRCLIPM4	563100	M4	35	41	11	0.01
DRCLIPM6	563110	M6	35	41	11	0.01

ÉCROU DE COLLIER DRGN POUR RAIL DIN ASYMÉTRIQUE

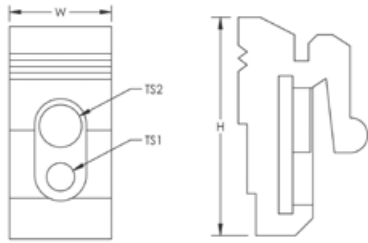

Référence	N° Article	Taille du filetage 1 TS1	Taille du filetage 2 TS2	Largeur W mm	Hauteur H mm	kg
DRGNM5	558070	M3	M5	12	25	0.038
DRGNM6	558080	M4	M6	12	25	0.038

SUPPORT D'ANGLE IRS

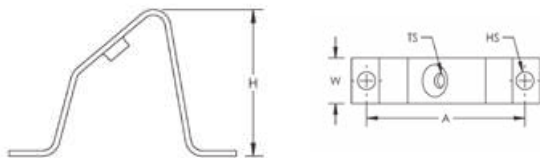

Référence	N° Article	Taille du filetage TS	Dimension du trou HS mm	Largeur W mm	Hauteur H mm	A mm	kg
IRS5	557970	M5	6.5	18	48	60	0.038
IRS6	557980	M6	6.5	18	48	60	0.038

SUPPORT D'ANGLE EN ACIER SB

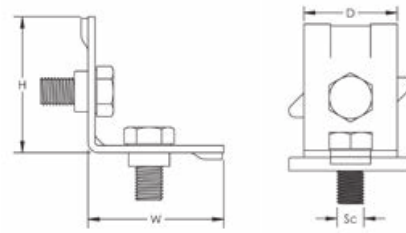

Référence	N° Article	Diamètre de la vis Sc	Largeur W mm	Hauteur H mm	Profondeur D mm	kg
SB30X30	557770	M8	30	30	28	0.06
SB40X40	557720	M8	40	40	28	0.07

ÉCROU POUR PROFIL SN POUR RAIL DIN

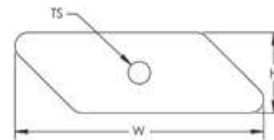

Référence	N° Article	Taille du filetage TS	Largeur W mm	Hauteur H mm	kg
SNP-M4	560500	M4	37	12	0.02
SNP-M5	560510	M5	37	12	0.02
SNP-M6	560520	M6	37	12	0.02
SNP-M8	560530	M8	37	12	0.02

Index

N° Article	Page
569010	6
569020	6
569030	6
569040	6
569041	6
569050	6
569252	6
569052	6
569251	6
569051	6
569060	6
569201	6
569202	6
569204	6
569206	6
569203	6
569205	6
569208	6
569207	6
569210	6
569209	6
569010	7
569020	7
569150	7
569030	7
569150	7
569040	8
569160	8
569041	8
569050	9
569170	9
569060	9
569251	11
569051	11
569200	11
569252	11
569052	11
569201	12
569204	13
569206	13

N° Article	Page
569203	14
569205	14
569208	15
569207	15
569210	16
569209	16
563720	18
563740	18
563900	18
563910	18
563920	18
563930	18
563940	18
563800	18
563810	18
563820	18
563830	18
563840	18
563200	18
563990	18
563995	18
563720	19
563740	19
563900	19
563910	19
563920	19
563930	19
563940	19
563841	19
563201	19
563800	20
563810	20
563820	20
563830	20
563840	20
563990	20
563995	22
561160	24
561150	24
561158	24

N° Article	Page
561161	24
561162	24
561151	24
561171	24
561163	24
561159	24
561170	24
561166	24
561154	24
561165	24
561153	24
561167	24
561155	24
561172	24
561164	24
561152	24
561168	24
561156	24
561169	24
561157	24
561173	24
561174	24
561175	24
561176	24
561177	24
561160	25
561150	25
561158	26
561162	27
561151	27
561171	28
561163	28
561159	29
561170	29
561166	30
561154	30
561165	31
561153	31
561167	32
561155	32

Index

N° Article	Page
561172	33
561164	33
561152	34
561168	34
561156	35
561169	35
561157	36
561173	36
561174	37
561175	37
561176	38
561177	38
561132	40
561134	40
561136	40
561140	40
561141	40
561142	40
561143	40
561144	40
561145	40
561146	40
561147	40
561132	41
561134	41
561138	41
561136	41
561140	42
561142	42
561144	43
561146	43
561138	43
561141	44
561143	44
561145	45
561147	45
561138	45
563150	46
563160	46
563170	46

N° Article	Page
562010	46
563180	46
563190	46
551311	47
551321	47
551300	47
551250	47
568800	48
568805	48
568810	48
561560	50
561570	50
561580	50
561590	50
561600	50
561610	50
561620	50
561630	50
561640	50
561660	50
561670	50
561680	50
561690	50
561700	50
561710	50
561720	50
561730	50
561740	50
561750	50
561760	50
561770	50
561780	50
561790	50
561800	50
561810	50
561820	50
561830	50
561840	50
561850	50
560660	50

N° Article	Page
560670	50
560600	50
560610	50
560620	50
560630	50
560640	50
560650	50
560740	50
560750	50
560700	50
560710	50
560720	50
560730	50
563120	50
551330	50
551260	50
551280	50
560800	50
560810	50
560820	50
560830	50
560840	50
560850	50
558050	51
558060	51
557950	51
557960	51
557750	51
557850	51
557855	51
557860	51
557780	51
557520	51
557790	51
557500	51
558000	51
558010	51
557900	51
557910	51
557700	51

Index

N° Article	Page
557800	51
557810	51
563100	52
563110	52
558070	52
558080	52
557970	52
557980	52
557770	52
557720	52
560500	52
560510	52
560520	52
560530	52

AUTRES DOCUMENTATIONS



CONDUCTEURS FLEXIBLES



OUTILLAGES HYDRAULIQUES ET MANUELS



SOLUTIONS POUR CONNEXIONS DE PUISSANCES ET DE MISE À LA TERRE



NVENT ERIFLEX IBS & IBSB ADVANCED GUIDE TECHNIQUE



NVENT ERIFLEX FLEXIBAR GUIDE TECHNIQUE

Notre éventail complet de marques:

CADDY ERICO HOFFMAN RAYCHEM SCHROFF TRACER



[nVent.com/ERIFLEX](https://www.nVent.com/ERIFLEX)