

A  
These dimensions will be especially checked at delivery  
Only inspection dimensions  
With /E marked dimensions are only valid for internal use

C  
Diese Maße werden bei Abnahme besonders geprüft  
Ausschließlich Prüfmaße  
Mit /E gekennzeichnete Maße sind nur für interne Zwecke gültig

E  
F

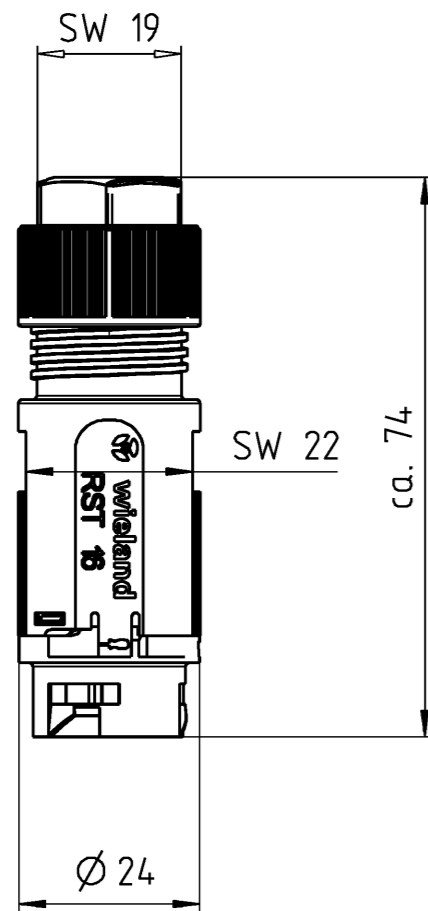

Kodierung/  
coding

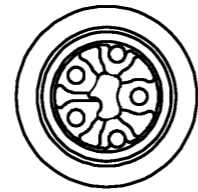

C1

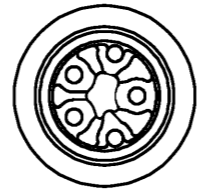

C2

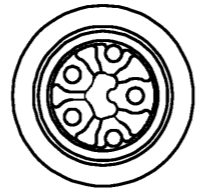

C3

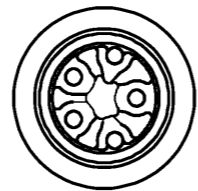

C4

Auslieferungszustand  
delivery condition

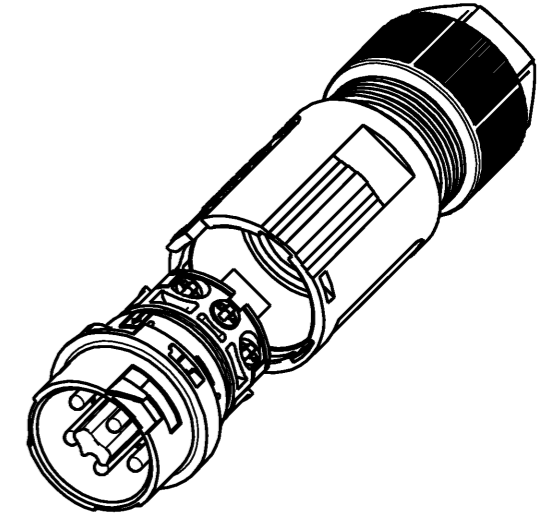
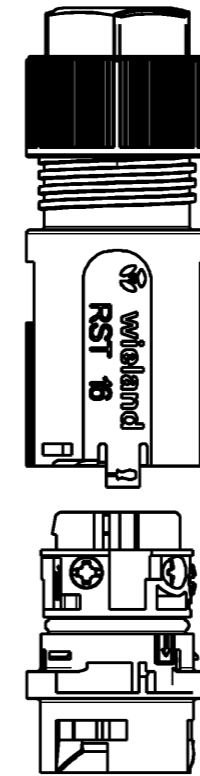

Weitergabe sowie Vervielfältigung dieses Dokuments, Verwertung und Mitteilung seines Inhalts sind verboten, soweit nicht ausdrücklich gestattet. Die Reproduktion, Distribution und Utilization of this document as well as the communication of its contents to others without express authorization is prohibited.

46.052.4553.9	RST16i5	S S1 ZT6S H BL	C4	lichtblau/light blue
46.052.4550.4	RST16i5	S S1 ZT6S L BR	C3	signalbraun/signal brown
46.052.4553.6	RST16i5	S S1 ZT6S A TB	C2	türkisblau/turquoise blue
46.052.4553.1	RST16i5	S S1 ZT6 SW	C1	schwarz/black
46.052.4553.0	RST16i5	S S1 ZT6S GL	C1	lichtgrau/light grey

Bestellnummer/ order number	Typ/type	Kodierung/c oding	Farbe/color
--------------------------------	----------	----------------------	-------------

Tolerierung Size ISO 14405 (E) / Tolerance system Size ISO 14405 (E). (This ISO-standard describes the envelope principle. According to the envelope principle the deviations of form and parallelism are limited by the size tolerances). ja/yes  Stoffverbots- und Deklarationsliste nach WN 5020.010 ist einzuhalten. Conformity with Wieland document WN 5020.010 e (list of prohibited / declarable hazardous substances) to be declared!

Freitoleranz nach General tolerance CAD - Zeichnung, keine manuellen Änderungen CAD - drawing, no manual modifications allowed 1. Verwendung: First Use. Blatt: 1 von 1 Sheet: 1 of 1

Werkstoff / Material	Tag/Date	Name	Zeichnung Nr. / Drawing No.	Index
Maßstab / Scale	gezeichnet/drawn	Treschan		
%	geprüft/checked		T 46.052.4553.013K	a
Vol.. --- mm <sup>3</sup>	OfL./Surf. --- mm <sup>2</sup>	Ersatz für / Replacement for:		
Maße in mm / Dimensions are in mm				

a	05.10.2016	 www.wieland-electric.com	Type	RST16	Benennung/Title	Steckerteil
Index	Datum / Blatt Date / Sheet		mit Zugentlastung, 5-polig, male connector with strain relief, 5 poles			
Änderung / Revision						