

SMALL LINE PL REFLECTOR

Part number 3115685

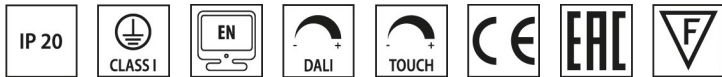
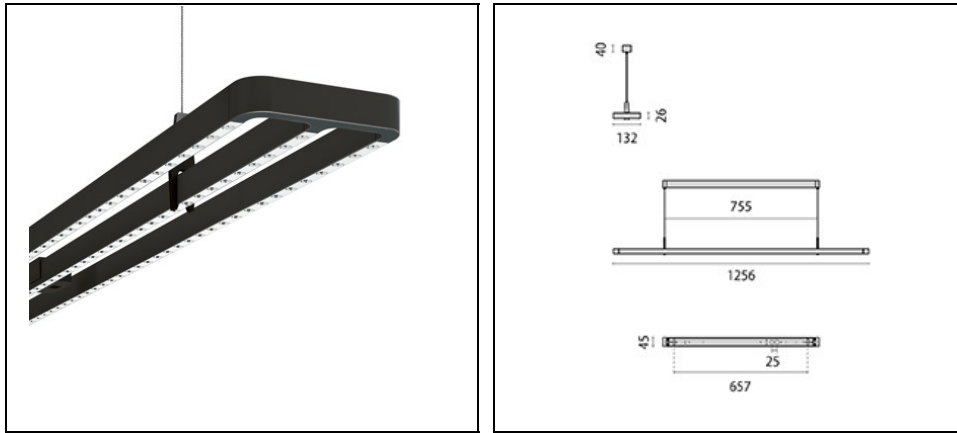

Description

Suspended, LED luminaire for indoor, comprising:

- Extruded aluminium profile housing, die-cast aluminium end caps, steel sheet canopy, painted
- Slender plates with open spaces give the luminaire a uniquely delicate design
- Direct / indirect light distribution
- Gear tray with high-shine multifaceted reflectors made of pure aluminium for maximum luminaire efficiency and neutral colour rendering
- Colour tolerance according to MacAdam ≤ 3 SDCM
- Complete with steel suspension cable (1.5 m) and canopy
- The luminaire unit is attached to the cable suspension without tools using clips
- Power is supplied via the cable suspension, no additional supply cable is required
- VDU application suitable acc. to EN 12464-1
- Sensor device available with task oriented PIR detector and daylight control
- Special colour versions available. Consult factory
- Bluetooth sensor component for use with dimSMART! light control
- Design by BÜRO SOMMER

To maintain the regular updating of our products, PERFORMANCE IN LIGHTING reserves the right to make changes without prior notice. For the most up to date information we always recommend you read the latest version published on the website www.performanceinlighting.com. Delivered luminaire lumen outputs and power consumptions, including losses, are subject to a tolerance of +/- 7%, and unless otherwise stated the values apply to an ambient temperature of 25°C. Terms of warranty are available at www.performanceinlighting.com/qr/qr/company/terms-and-conditions

Product data

ETIM Group:	EG000027	ETIM Class:	EC001743
-------------	----------	-------------	----------

General information

Lampholder:	LED	Light source:	LED
Lightsource lumen output [lm]:	10400	Luminaire lumen output [lm]:	7870
Luminaire wattage [W]:	69 W	Luminous efficacy [lm/W]:	0
CRI:	80	Kelvin:	4000
Colour / Finish:	BK-RAL9005 / Black RAL9005 / Textured	IP degree of protection:	IP20
IK-J-xxIP:	IK03 0.35J xx1	Insulation class:	I
Optic:	SYMMETRIC DIRECT-INDIRECT	Beam angle:	2 x 37°
Net weight [kg]:	2.168		

Mechanical features

Shape:	RECTANGULAR	Housing material:	ALUMINIUM
Glow wire test [°C]:	650 °C		

Electrical features

Voltage type:	AC	Power factor / COS Φ :	>0.9
---------------	----	-----------------------------	------

Installation

Application area:	Indoor	Mounting type:	Suspended
Min. ambient temperature [°C]:	10	Max. ambient temperature [°C]:	40
Min. distance from lighted object [m]:	0.00		

Light features

MacAdam:	3	Lumen maintenance:	L80B10@50000h
Distribution of light emission:	Direct/ Indirect	DFF - Downward Flux Fraction [%]:	40
UFF - Upward Flux Fraction [%]:	60	UGR max.:	8.0

To maintain the regular updating of our products, PERFORMANCE IN LIGHTING reserves the right to make changes without prior notice. For the most up to date information we always recommend you read the latest version published on the website www.performanceinlighting.com. Delivered luminaire lumen outputs and power consumptions, including losses, are subject to a tolerance of +/- 7%, and unless otherwise stated the values apply to an ambient temperature of 25°C. Terms of warranty are available at www.performanceinlighting.com/qr/qr/company/terms-and-conditions

Photometric data



To maintain the regular updating of our products, PERFORMANCE IN LIGHTING reserves the right to make changes without prior notice. For the most up to date information we always recommend you read the latest version published on the website www.performanceinlighting.com. Delivered luminaire lumen outputs and power consumptions, including losses, are subject to a tolerance of +/- 7%, and unless otherwise stated the values apply to an ambient temperature of 25°C. Terms of warranty are available at www.performanceinlighting.com/qr/qr/company/terms-and-conditions