

ART.: 8435164453310

EB435 LED MEDIUM REFLECTOR

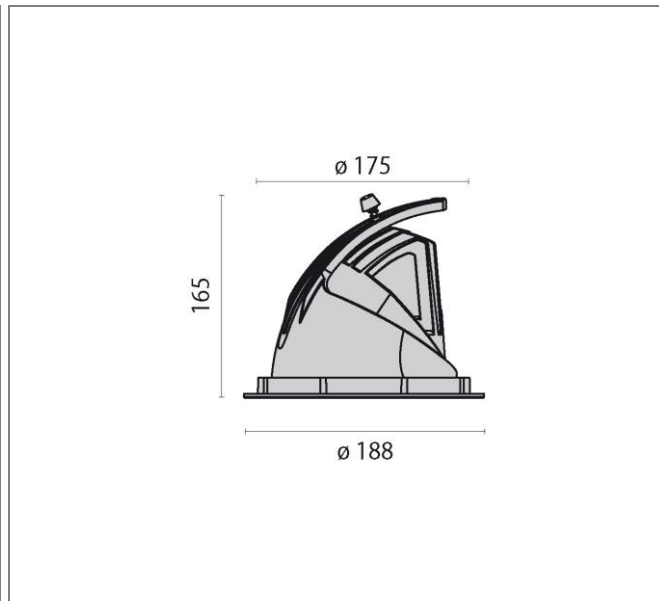

Art.: 8435164453310, EB435 LED, 40W, 3000K, Driver static, Direct / medium (2 x 11°-22°), White, Recessed LED luminaire for indoors, consisting of: Die-cast aluminum spotlight body and ring, powder-coated, Reflector can be swivelled horizontally inwards and outwards thanks to the unique swivel mechanism, Adjustable about 60° (from -15° up to 45°, rotatable about 355°, High-brilliance spherical faceted reflector for maximum lamp performance and neutral colour rendering, Reflector in Medium design, Colour rendering index Ra > 90, Colour tolerance according to MacAdam ≤ 3 SDCM Toolless mounting, Complete with electric converter, Anchor springs, Complete with clear safety glass pane

Connected load	40 W
Luminous flux	4130 lm
Efficiency	103 lm/W
Colour temperature	3000K
Colour rendering (CRI)	80
IP class	20
Nominal voltage	220 – 240 V
Colour	RAL 9010

