

ART.: 8629261406410

SL629 PL PRISM

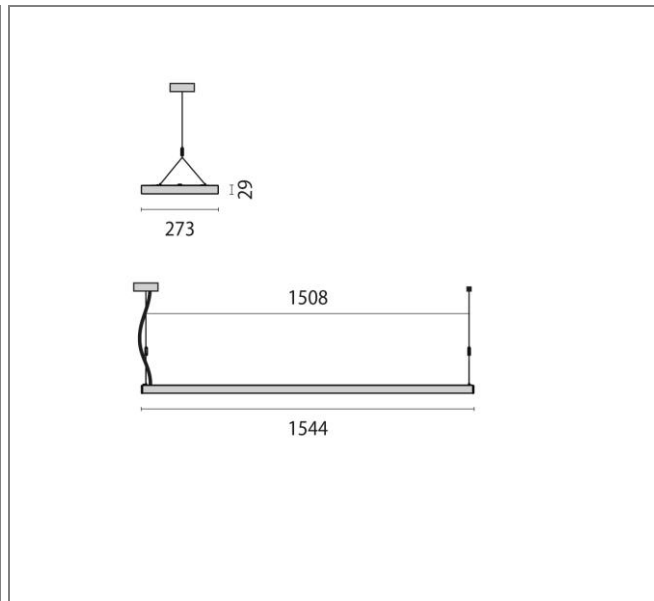

Art.: 8629261406410, SL629 PL, Prismenstruktur, 31W, 4000K, Driver dali, 1544mm, Symmetrical - direct, White, LED suspended luminaire for interior, comprising: Housing made of steel sheet, die-cast aluminium end caps, powder painted / Prismatic cover for efficient light diffusion, glare reduction and a high level of uniformity / Direct light distribution / LED Sidelight-Technology for a homogenous light distribution over the entire area of the cover / Colour rendering index Ra > 80 / Colour tolerance according to MacAdam = 3 SDCM / Dimmable via TouchDIM® / Light engine can be replaced by means of a slide-in mechanism / Complete with steel suspension cable (1.5 m), transparent power cord and ceiling rose / DALI dimmable / VDU application suitable acc. to EN 12464-1 (see table) / Special colour versions available upon request

Connected load	31 W
Luminous flux	4000 lm
Efficiency	129 lm/W
Colour temperature	4000K
Colour rendering (CRI)	80
IP class	20
Nominal voltage	220 – 240 V
Colour	WH-RAL9016
UGR	16,4
Glare control	✓

