

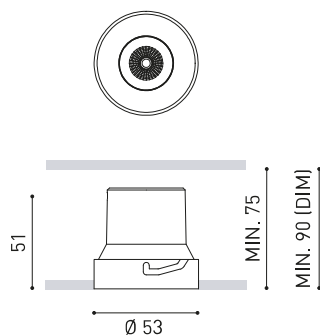

## DIMENSIONS



## ACCESSOIRES

TRIMLESS ACCESSORY  
(MANDATORY)

TRIMLESS TOOL

Nom	SHOT LIGHT S TRIMLESS FLOOD DIM PH.CUT 3500K W
Référence	A4630513W
Couleur	Blanc
RAL	Couleur de masse similaire à RAL 9016
Catégorie	CEILING RECESSED

Type	LED
Flux lumineux brut	630 lm
Température de couleur	3500 K
Stabilité chromatique	MacAdam Step 2
Indice de reproduction chromatique	CRI >90
Puissance	6 W
Courant	500 mA
Efficacité	105 lm/W
Durée de vie de la LED	L80B10 >60.000h

## SOURCE DE LUMIÈRE

## LUMINAIRE | DONNÉS PHOTOMÉTRIQUES

Efficacité lumineuse	78%
Angle du faisceau lumineux	39°

## LUMINAIRE | DONNÉS ÉLECTRIQUES

Driver	Inclus - Connecté
Valeurs de puissance du système	8,28 W
Tension	220V/240V
Fréquence	50/60 Hz
Variation d'intensité	Coupe de phase - Autres DIM, veuillez consulter
Classe d'isolation électrique	<input type="checkbox"/>

## D'AUTRES DONNÉES

Étanchéité	IP20
Contrôle sans fil	Veuillez consulter
Alimentation d'urgence	Veuillez consulter
Dimensions d'encastrement	Ø59 mm
Poids	145 g
Poids avec emballage	215 g
Dimensions de l'emballage	173 x 85 x 74 mm
Unités par emballage	1
Matériaux	Aluminium / Acrylonitrile Butadiène Styrène / Polycarbonate



Un luminaire conçu pour constituer un point d'éclairage discret au plafond, permettant de masquer l'origine de l'éclairage tout en cherchant le plus haut confort visuel. Pour ce faire, il est équipé d'un écran anti-éblouissement et d'un micro-reflecteur (spécialement conçu) produisant un faisceau lumineux parfaitement défini.

DIAGRAMME POLAIRE



DIAGRAMME CONIQUE

UGR

Glare Evaluation According to UGR											
ρ Ceiling	70	70	50	50	30	70	70	50	50	30	
ρ Walls	50	30	50	30	30	50	30	50	30	30	
ρ Floor	20	20	20	20	20	20	20	20	20	20	
Room Size X Y	Viewing direction at right angles to lamp axis					Viewing direction parallel to lamp axis					
2H	2H	-9.8	-9.2	-9.6	-9.0	-8.8	-10.7	-10.0	-10.4	-9.8	-9.6
	3H	-6.4	-5.8	-6.1	-5.6	-5.4	-6.5	-5.9	-6.2	-5.7	-5.5
	4H	-4.9	-4.4	-4.6	-4.1	-3.9	-4.7	-4.1	-4.4	-3.9	-3.6
	6H	-2.8	-2.3	-2.5	-2.0	-1.7	-2.8	-2.3	-2.5	-2.0	-1.7
	8H	-1.3	-0.8	-1.0	-0.5	-0.2	-1.4	-0.9	-1.1	-0.7	-0.4
12H	0.0	0.5	0.3	0.8	1.1	0.0	0.5	0.4	0.8	1.1	
4H	2H	-8.8	-8.2	-8.5	-8.0	-7.7	-9.3	-8.8	-9.0	-8.5	-8.3
	3H	-5.0	-4.5	-4.6	-4.2	-3.9	-5.1	-4.6	-4.7	-4.3	-4.0
	4H	-3.3	-2.9	-2.9	-2.5	-2.2	-3.1	-2.7	-2.7	-2.4	-2.0
	6H	-1.1	-0.8	-0.7	-0.4	-0.0	-1.1	-0.8	-0.7	-0.5	-0.1
	8H	0.5	0.8	0.9	1.1	1.5	0.3	0.6	0.7	1.0	1.4
12H	1.9	2.1	2.3	2.5	3.0	1.9	2.1	2.3	2.5	3.0	
8H	4H	-2.4	-2.1	-2.0	-1.8	-1.4	-2.3	-2.0	-1.9	-1.6	-1.2
	6H	0.0	0.3	0.5	0.7	1.1	-0.0	0.2	0.4	0.6	1.1
	8H	1.8	1.9	2.2	2.4	2.8	1.6	1.8	2.1	2.2	2.7
	12H	3.4	3.5	3.9	4.0	4.5	3.4	3.6	3.9	4.0	4.5
12H	4H	-2.2	-1.9	-1.8	-1.5	-1.1	-2.1	-1.8	-1.6	-1.4	-1.0
	6H	0.4	0.6	0.9	1.0	1.5	0.3	0.5	0.8	1.0	1.4
	8H	2.2	2.4	2.7	2.8	3.3	2.1	2.2	2.5	2.7	3.2
Variation of the observer position for the luminaire distances S											
S = 1.0H	+1.6 / -0.5					+1.8 / -0.6					
S = 1.5H	+3.3 / -0.9					+3.6 / -0.9					
S = 2.0H	+4.9 / -1.0					+5.3 / -1.2					
Standard table Correction Summand	---					---					
Corrected Glare Indices referring to 630lm Total Luminous Flux											

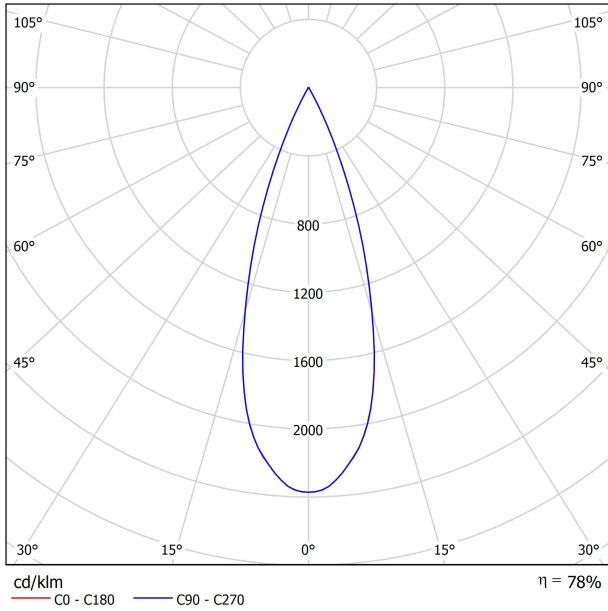
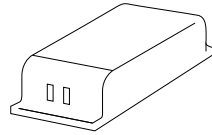

## DRIVER

0000-94-44	DRIVER PHASE CUT 7W 500mA
------------	---------------------------

## PHASE CUT DIMMERS TESTED FOR COMPATIBILITY:

Brand / Manufacturer	Model number	Dimming Type
Busch-Jaeger	6523 U-102	Trailing edge
Busch-Jaeger	6523 UR-103	Trailing edge
Niko	310-0190X	Trailing edge
Jung	LB-Management	Trailing edge
HZC Electric	AU-P3	Trailing edge
Philips	SED-200A	Trailing edge
Merten/Schneider	SBD315RC	Trailing edge
Etman	ETM327	Trailing edge
Etman	ETM329	Trailing edge
Etman (EGANT)	U321V2	Trailing edge
Casambi	CBU-TED	Trailing edge

THE PARTICULAR CONDITIONS OF EACH INSTALLATION AND THE SPECIFICATIONS AND CONDITIONS OF USE OF EACH REGULATOR, MAY DIFFER FROM THOSE CONSIDERED IN THE COMPATIBILITY TESTING, AND AFFECT ITS PERFORMANCE IN SAID INSTALLATION.

MANDATORY FOR INSTALLATION

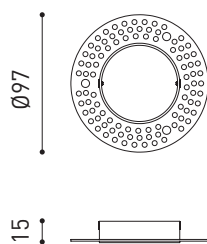

PRODUCT	
Model	Shot Light S Trimless accessory
Reference	A4630000
Material	Iron
Coating	Zinc plated
Category	Accessories





INSTALLATION GUIDE

[https://youtu.be/sa\\_xAgj4ji4](https://youtu.be/sa_xAgj4ji4)

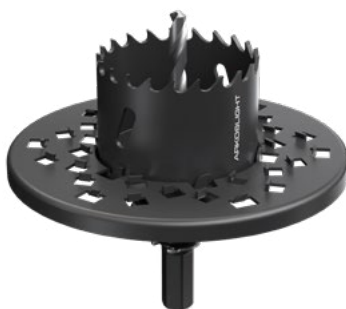

PRODUCT

Model	Trimless Tool <b>D59 X D100 MM</b>
Reference	A478-00-03
Category	Accessories

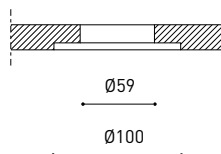
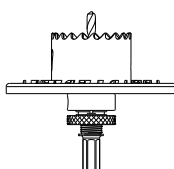



Fuente de luz (LED) reemplazable por un profesional autorizado

Replaceable (LED only) light source by an authorized professional.

Source lumineuse (LED) remplaçable par un professionnel agréé

Sorgente luminosa (LED) sostituibile da parte di un professionista autorizzato

Austauschbare (LED) Lichtquelle durch einen autorisierten Fachmann



Equipo de control reemplazable por un profesional autorizado

Replaceable control gear by an authorized professional

Dispositif de commande remplaçable par un professionnel agréé

Alimentatore sostituibile da parte di un professionista autorizzato

Auswechselbares Betriebsgerät durch autorisierten Fachmann

INSTRUCCIONES PARA EL FINAL DE VIDA Y LA ELIMINACIÓN LOS COMPONENTES  
 INSTRUCTIONS ON END-OF-LIFE AND COMPONENT DISPOSAL  
 INSTRUCTIONS POUR LA GESTION DES COMPOSANTS EN FIN DE VIE ET LEUR MISE AU REBUT  
 ISTRUZIONI PER IL FINE VITA E LO SMALTIMENTO DEI COMPONENTI  
 ANWEISUNGEN ZUR ENTSORGUNG DER LEUCHTENKOMPONENTEN



Interrumpir la alimentación del aparato  
 Cut the power supply to the luminaire  
 Couper l'alimentation du luminaire  
 Interrompere l'alimentazione dell'apparecchio  
 Stromversorgung der Leuchte unterbrechen



Quitar la(s) fuente(s) de luz para el desecho  
 Remove light source(s) for disposal  
 Retirer la (les) source(s) lumineuse(s) pour l'élimination  
 Rimuovere la/le sorgente/e di luce per lo smaltimento  
 Lichtquelle(n) zur Entsorgung entfernen



Quitar la batería para el desecho  
 Remove the battery for decommissioning  
 Retirer la batterie pour sa mise au rebut  
 Rimuovere la batteria per la dismissione  
 Die Batterie ordnungsgemäß entsorgen



Quitar el equipo de control para el desecho  
 Remove control gear for disposal  
 Retirer le dispositif de commande pour l'élimination  
 Rimuovere l'alimentatore per lo smaltimento  
 Betriebsgerät zur Entsorgung ausbauen



Enviar los materiales a un centro de recogida RAEE  
 Send the materials to a WEEE collection centre  
 Envoyer les matériaux dans une déchetterie DEEE  
 Inviare i materiali ad un centro di raccolta RAEE  
 Die Materialien in einem WEEE-Zentrum entsorgen

