

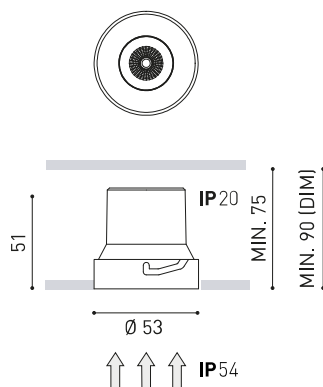

DIMENSIONS



ACCESSOIRES

TRIMLESS ACCESSORY
(MANDATORY)

TRIMLESS TOOL

Nom	SHOT LIGHT S TRIMLESS IP54 FLOOD 2700K W
Référence	A4631110W
Couleur	Blanc
RAL	Couleur de masse similaire à RAL 9016
Catégorie	CEILING RECESSED

Type	LED
Flux lumineux brut	580 lm
Température de couleur	2700 K
Stabilité chromatique	MacAdam Step 2
Indice de reproduction chromatique	CRI >90
Puissance	6 W
Courant	500 mA
Efficacité	97 lm/W
Durée de vie de la LED	L80B10 >60.000h

Efficacité lumineuse	78%
Angle du faisceau lumineux	34°

Driver	Inclus - Connecté
Valeurs de puissance du système	7,33 W
Tension	220V/240V
Fréquence	50/60 Hz
Variation d'intensité	Non Dim - Autres DIM, veuillez consulter
Classe d'isolation électrique	<input type="checkbox"/>

Étanchéité	IP54
Contrôle sans fil	Veuillez consulter
Alimentation d'urgence	Veuillez consulter
Dimensions d'encastrement	Ø59 mm
Poids	110 g
Poids avec emballage	155 g
Dimensions de l'emballage	86 x 86 x 75 mm
Unités par emballage	1
Matériaux	Aluminium / Acrylonitrile Butadiène Styrène / Polycarbonate

PRODUIT

SOURCE DE LUMIÈRE

LUMINAIRE | DONNÉS PHOTOMÉTRIQUES

LUMINAIRE | DONNÉS ÉLECTRIQUES

D'AUTRES DONNÉES



Un luminaire conçu pour constituer un point d'éclairage discret au plafond, permettant de masquer l'origine de l'éclairage tout en cherchant le plus haut confort visuel. Pour ce faire, il est équipé d'un écran anti-éblouissement et d'un micro-reflecteur (spécialement conçu) produisant un faisceau lumineux parfaitement défini.

DIAGRAMME POLAIRE



DIAGRAMME CONIQUE



UGR

Glare Evaluation According to UGR											
ρ Ceiling	70	70	50	50	30	70	70	50	50	30	30
ρ Walls	50	30	50	30	30	50	30	50	30	30	30
ρ Floor	20	20	20	20	20	20	20	20	20	20	20
Room Size X Y		Viewing direction at right angles to lamp axis					Viewing direction parallel to lamp axis				
2H	2H	-10.1	-9.5	-9.9	-9.3	-9.1	-10.9	-10.3	-10.7	-10.1	-9.9
	3H	-6.7	-6.1	-6.4	-5.9	-5.7	-6.8	-6.2	-6.5	-6.0	-5.8
	4H	-5.2	-4.7	-4.9	-4.4	-4.2	-4.9	-4.4	-4.6	-4.2	-3.9
	6H	-3.1	-2.6	-2.8	-2.3	-2.0	-3.1	-2.6	-2.8	-2.3	-2.0
	8H	-1.6	-1.1	-1.3	-0.8	-0.5	-1.7	-1.2	-1.4	-0.9	-0.7
4H	12H	-0.3	0.2	0.1	0.5	0.8	-0.3	0.2	0.1	0.5	0.8
	2H	-9.0	-8.5	-8.8	-8.3	-8.0	-9.6	-9.1	-9.3	-8.8	-8.6
	3H	-5.3	-4.8	-4.9	-4.5	-4.2	-5.4	-4.9	-5.0	-4.6	-4.3
	4H	-3.5	-3.2	-3.2	-2.8	-2.5	-3.4	-3.0	-3.0	-2.7	-2.3
	6H	-1.4	-1.1	-1.0	-0.7	-0.3	-1.4	-1.1	-1.0	-0.7	-0.4
8H	8H	0.2	0.5	0.6	0.9	1.3	0.0	0.3	0.4	0.7	1.1
	12H	1.6	1.9	2.0	2.2	2.7	1.6	1.9	2.0	2.3	2.7
	4H	-2.7	-2.4	-2.3	-2.0	-1.6	-2.6	-2.3	-2.2	-1.9	-1.5
	6H	-0.2	-0.0	0.2	0.4	0.8	-0.3	-0.1	0.1	0.3	0.8
	8H	1.5	1.7	1.9	2.1	2.6	1.3	1.5	1.8	1.9	2.4
12H	12H	3.1	3.3	3.6	3.7	4.2	3.1	3.3	3.6	3.7	4.2
	4H	-2.5	-2.2	-2.0	-1.8	-1.4	-2.3	-2.1	-1.9	-1.7	-1.3
	6H	0.1	0.3	0.6	0.7	1.2	0.1	0.2	0.5	0.7	1.1
8H	1.9	2.1	2.4	2.5	3.0	1.8	1.9	2.3	2.4	2.9	
Variation of the observer position for the luminaire distances S											
S = 1.0H	+1.6 / -0.5					+1.8 / -0.6					
S = 1.5H	+3.3 / -0.9					+3.6 / -0.9					
S = 2.0H	+4.9 / -1.0					+5.3 / -1.2					
Standard table Correction Summand	---					---					
Corrected Glare Indices referring to 580lm Total Luminous Flux											

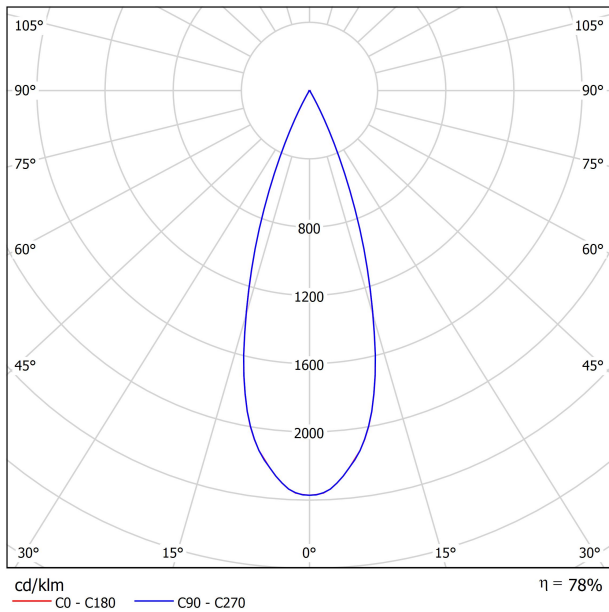
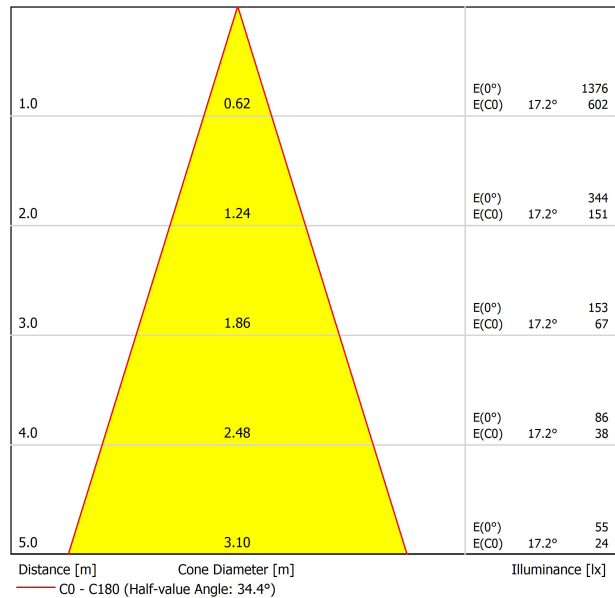
MANDATORY FOR INSTALLATION

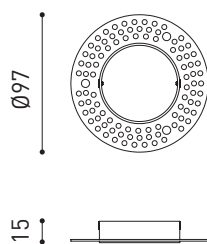

PRODUCT	
Model	Shot Light S Trimless accessory
Reference	A4630000
Material	Iron
Coating	Zinc plated
Category	Accessories





INSTALLATION GUIDE

https://youtu.be/sa_xAgj4ji4

PRODUCT

Model	Trimless Tool D59 X D100 MM
Reference	A478-00-03
Category	Accessories

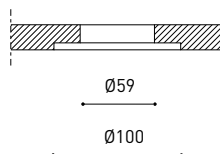
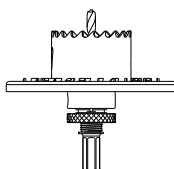

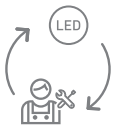

Fuente de luz (LED) reemplazable por un profesional autorizado
 Replaceable (LED only) light source by an authorized professional.
 Source lumineuse (LED) remplaçable par un professionnel agréé
 Sorgente luminosa (LED) sostituibile da parte di un professionista autorizzato
 Austauschbare (LED) Lichtquelle durch einen autorisierten Fachmann



Equipo de control reemplazable por un profesional autorizado
 Replaceable control gear by an authorized professional
 Dispositif de commande remplaçable par un professionnel agréé
 Alimentatore sostituibile da parte di un professionista autorizzato
 Auswechselbares Betriebsgerät durch autorisierten Fachmann

INSTRUCCIONES PARA EL FINAL DE VIDA Y LA ELIMINACIÓN LOS COMPONENTES
 INSTRUCTIONS ON END-OF-LIFE AND COMPONENT DISPOSAL
 INSTRUCTIONS POUR LA GESTION DES COMPOSANTS EN FIN DE VIE ET LEUR MISE AU REBUT
 ISTRUZIONI PER IL FINE VITA E LO SMALTIMENTO DEI COMPONENTI
 ANWEISUNGEN ZUR ENTSORGUNG DER LEUCHTENKOMPONENTEN



Interrumpir la alimentación del aparato
 Cut the power supply to the luminaire
 Couper l'alimentation du luminaire
 Interrompere l'alimentazione dell'apparecchio
 Stromversorgung der Leuchte unterbrechen

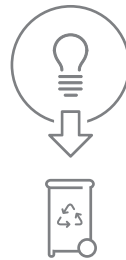

Quitar la(s) fuente(s) de luz para el desecho
 Remove light source(s) for disposal
 Retirer la (les) source(s) lumineuse(s) pour l'élimination
 Rimuovere la/le sorgente/e di luce per lo smaltimento
 Lichtquelle(n) zur Entsorgung entfernen

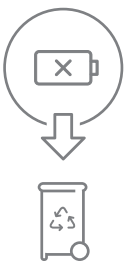

Quitar la batería para el desecho
 Remove the battery for decommissioning
 Retirer la batterie pour sa mise au rebut
 Rimuovere la batteria per la dismissione
 Die Batterie ordnungsgemäß entsorgen



Quitar el equipo de control para el desecho
 Remove control gear for disposal
 Retirer le dispositif de commande pour l'élimination
 Rimuovere l'alimentatore per lo smaltimento
 Betriebsgerät zur Entsorgung ausbauen

Enviar los materiales a un centro de recogida RAEE
 Send the materials to a WEEE collection centre
 Envoyer les matériaux dans une déchetterie DEEE
 Inviare i materiali ad un centro di raccolta RAEE
 Die Materialien in einem WEEE-Zentrum entsorgen

