

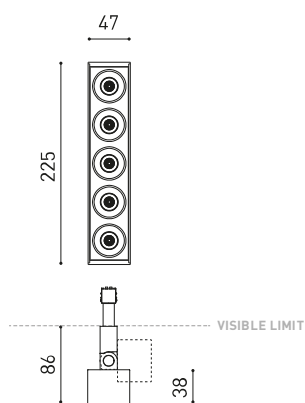

DIMENSIONS



ACCESSOIRES



TRACK 48V OPTIONS

Nom	BLACK FOSTER 48V TILT 5 FLOOD 4000K NT
Référence	A4814012NT
Couleur	Noir Texturé
RAL	9005
Catégorie	TRACKLIGHTS

Type	LED
Flux lumineux brut	1250 lm
Température de couleur	4000 K
Stabilité chromatique	MacAdam Step 3
Indice de reproduction chromatique	CRI > 90
Puissance	10,5 W
Courant	700 mA
Efficacité	119 lm/W
Durée de vie de la LED	L90B10 > 102.000h

Efficacité lumineuse	92%
Angle du faisceau lumineux	38°

Driver	Inclus
Valeurs de puissance du système	11,72 W
Tension	48Vdc
Variation d'intensité	Non Dim
Classe d'isolation électrique	II

Étanchéité	IP20
Contrôle sans fil	Veillez consulter
Angle de basculement	90°
Angle de rotation	360°
Type de rail	Track 48V
Poids	450 g
Poids avec emballage	550 g
Dimensions de l'emballage	268 x 172 x 62 mm
Unités par emballage	1
Matériaux	Aluminium / Acrylonitrile Butadiène Styrène / Polycarbonate

PRODUIT

SOURCE DE LUMIÈRE

LUMINAIRE | DONNÉS PHOTOMÉTRIQUES

LUMINAIRE | DONNÉS ÉLECTRIQUES

D'AUTRES DONNÉES

Le nouveau luminaire Black Foster 48V Tilt ajoute une nouvelle fonction pivotante au rail 48V. Il peut tourner sur son axe 360° et basculer 90°. Grâce à cette nouvelle fonction proposée, la lumière est projetée avec flexibilité, donnant lieu à des scènes séduisantes.

DIAGRAMME POLAIRE



DIAGRAMME CONIQUE



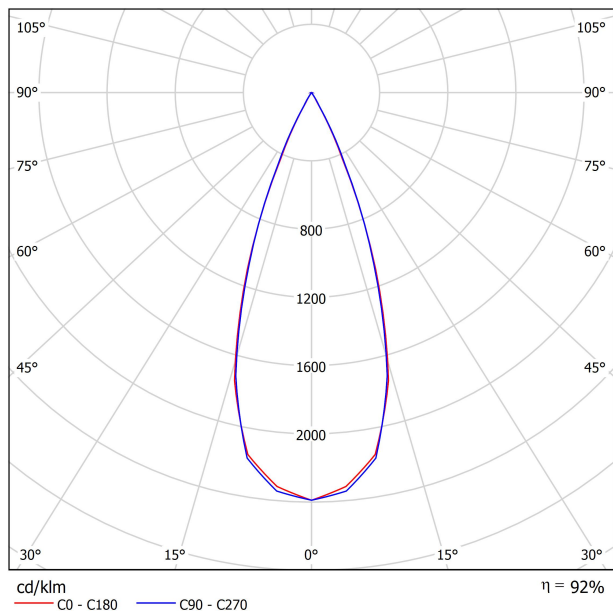
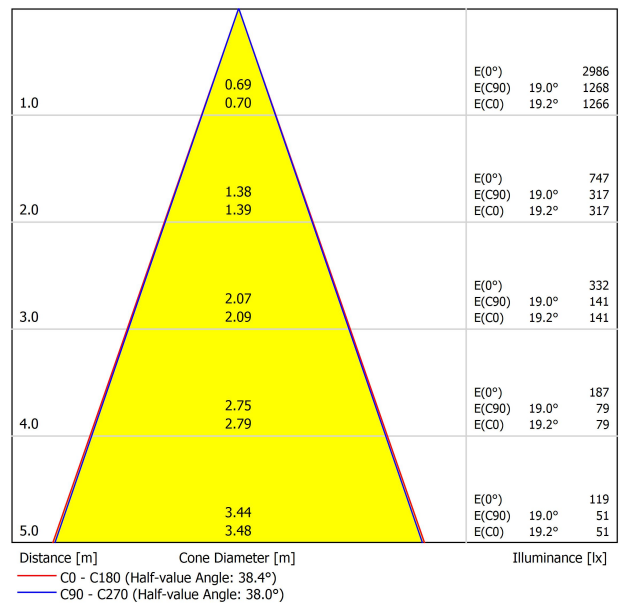
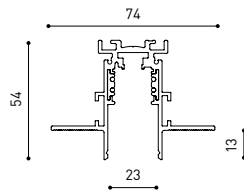

TRACK 48V TRIMLESS

TRACK 48V TRIMLESS 1m	A338-01-00- N WT
TRACK 48V TRIMLESS 2m	A338-02-00- N WT
TRACK 48V TRIMLESS 3m	A338-03-00- N WT
TRACK 48V TRIMLESS Corner 90° One Plane	A338-06-00- N WT
TRACK 48V TRIMLESS Corner 90° Two Planes	A338-07-00- N WT

PLASTERBOARD CEILING, MANDATORY THICKNESS 12,5mm.
RECOMMENDED FOR INSTALLATIONS WHERE THE PROFILE CAN BE
INSTALLED BEFORE THE FALSE PLASTERBOARD CEILING.



TRIMLESS INSTALLATION GUIDE
<https://youtu.be/tgGsQdaYe-w>

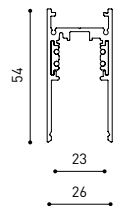

TRACK 48V SURFACE

TRACK 48V SURFACE 1m	A338-11-00- NT WT
TRACK 48V SURFACE 2m	A338-12-00- NT WT
TRACK 48V SURFACE 3m	A338-13-00- NT WT
TRACK 48V SURFACE Corner 90° One Plane	A338-14-00- NT WT



TRACK 48V TRIMLESS Corner 90° One Plane

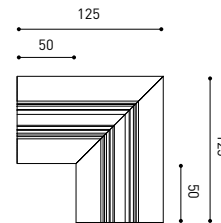

*Electrical connection not included

TRACK 48V TRIMLESS Corner 90° Two Planes

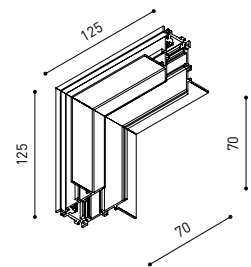

*Electrical connection not included

TRACK 48V SURFACE Corner 90° One Plane

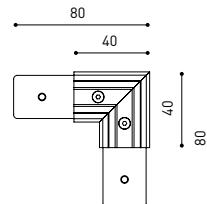

Electrical connection not included
Straight joiner included

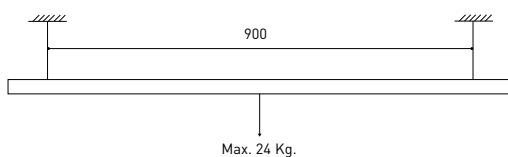

DROP VOLTAGE TABLE

POWER [W]	CABLE SECTION [mm ²]	CABLE LENGTH (m)			
		5	10	20	30
100	0,75	50	50	X	X
	1,5	50	50	40	25
150	0,75	40	15	X	X
	1,5	50	40	20	X

	P	V	D	
CONSTANT VOLTAGE LED POWER SUPPLY	0434-01-61* N	100W	48V	298 x 16 x 19 mm
	0434-01-62	150W	48V	350 x 30 x 18 mm

220 V₋
240

*To be installed inside the track.

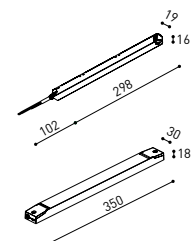

COLOUR | N ■ RAL 9005 | NT ■ RAL 9005 | WT □ RAL 9016 |

ALL 48V TRACK

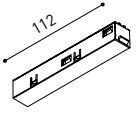

Live-End Connector 48V
A338-00-01- | W | N |

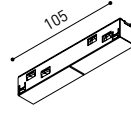

Central Connector 48V
A338-00-02- | W | N |

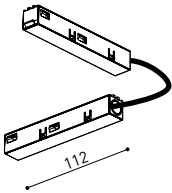

L-JOINT Connector 48V
A338-00-12- | W | N |

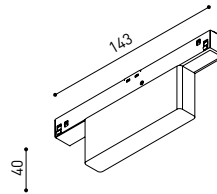

Wireless Control 48V
0434-01-31- | W | N | Casambi/AAG Stucchi App

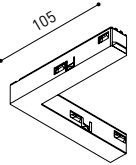

Corner 90° Connector One Plane 48V
A338-00-24- | W | N |

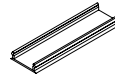

Cover Gap 1m 48V
A338-00-30- | N | W |

*Not suitable for trimless version

TRIMLESS 48V



Trimless T-Bracket 48V
A338-00-03



Trimless Clamp for M6 ROD 48V
A338-00-09
*See accessories quantities

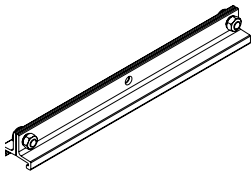

Trimless Long T-Bracket 48V
A338-00-04



Trimless Track Clamp 48V
A338-00-10
*See accessories quantities

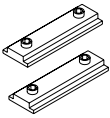

Trimless Straight Joiner 48V (2 Units)
A338-00-05- | WT | N |



Trimless Suspension Kit 48V
A338-00-08
*See accessories quantities

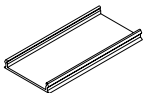

Trimless Plaster Installation Guard 1m 48V
A338-00-21

* SUGGESTED MOUNTING ACCESSORIES QUANTITIES
1000mm - 2 Pcs.
2000mm - 3 Pcs.
3000mm - 4 Pcs.

COLOUR | N ■ RAL 9005 | W □ RAL 9016 | NT ■ RAL 9005 | WT □ RAL 9016 |

TRIMLESS, SURFACE & SUSPENSION 48V



End 48V

A338-00-06- | WT | NT |



End feed 48V

A338-00-07- | WT | NT |

SURFACE, SUSPENSION 48V

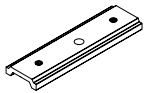

Surface Straight Joiner 48V

A338-00-11

SURFACE 48V

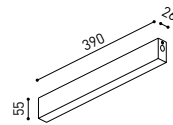

TRACK 48V Power Supply Case

A338-00-29- | NT | WT | 150 W

220 V - 240 V - INCL

*To be installed aside 48V Surface Tracks

SUSPENSION 48V

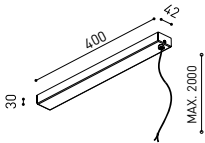

Wired Power Supply Case 48V

A338-00-25- | NT | WT | 150 W NO DIM

A338-00-26- | NT | WT | 150 W DIM

220 V - 240 V - INCL

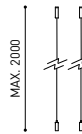

Suspension Kit 48V (2 units)

A338-00-15- | WT | NT |

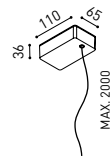

Suspension Feed Kit 48V

A338-00-16- | W | N | NO DIM

A338-00-17- | W | N | DIM

For remote power supply

A338-00-27- | W | N | NO DIM

A338-00-28- | W | N | DIM

For power supply inside the track

WIRE TRIMLESS ACCESSORIES

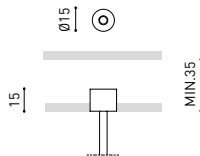

FEED

MAINS TRIMLESS*

A023-00-01- | W | N | NO DIM

MAINS THICK TRIMLESS*

A023-00-02- | W | N | DIM

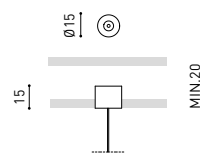

FASTENING

STEEL CABLE TRIMLESS*

A023-00-05- | W | N |



MAINS TRIMLESS

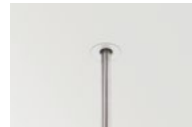

MAINS THICK TRIMLESS

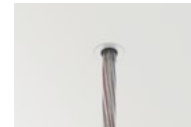

STEEL CABLE TRIMLESS



* AS MANY PIECES AS NEEDED ACCORDING TO YOUR PRODUCT

COLOUR | N ■ RAL 9005 | W □ RAL 9016 | NT ■ RAL 9005 | WT □ RAL 9016 |



Fuente de luz (LED) reemplazable por un profesional autorizado
 Replaceable (LED only) light source by an authorized professional.
 Source lumineuse (LED) remplaçable par un professionnel agréé
 Sorgente luminosa (LED) sostituibile da parte di un professionista autorizzato
 Austauschbare (LED) Lichtquelle durch einen autorisierten Fachmann



Equipo de control reemplazable por un profesional autorizado
 Replaceable control gear by an authorized professional
 Dispositif de commande remplaçable par un professionnel agréé
 Alimentatore sostituibile da parte di un professionista autorizzato
 Auswechselbares Betriebsgerät durch autorisierten Fachmann

INSTRUCCIONES PARA EL FINAL DE VIDA Y LA ELIMINACIÓN LOS COMPONENTES
 INSTRUCTIONS ON END-OF-LIFE AND COMPONENT DISPOSAL
 INSTRUCTIONS POUR LA GESTION DES COMPOSANTS EN FIN DE VIE ET LEUR MISE AU REBUT
 ISTRUZIONI PER IL FINE VITA E LO SMALTIMENTO DEI COMPONENTI
 ANWEISUNGEN ZUR ENTSORGUNG DER LEUCHTENKOMPONENTEN



Interrumpir la alimentación del aparato
 Cut the power supply to the luminaire
 Couper l'alimentation du luminaire
 Interrompere l'alimentazione dell'apparecchio
 Stromversorgung der Leuchte unterbrechen



Quitar la(s) fuente(s) de luz para el desecho
 Remove light source(s) for disposal
 Retirer la (les) source(s) lumineuse(s) pour l'élimination
 Rimuovere la/le sorgente/e di luce per lo smaltimento
 Lichtquelle(n) zur Entsorgung entfernen



Quitar la batería para el desecho
 Remove the battery for decommissioning
 Retirer la batterie pour sa mise au rebut
 Rimuovere la batteria per la dismissione
 Die Batterie ordnungsgemäß entsorgen



Quitar el equipo de control para el desecho
 Remove control gear for disposal
 Retirer le dispositif de commande pour l'élimination
 Rimuovere l'alimentatore per lo smaltimento
 Betriebsgerät zur Entsorgung ausbauen

Enviar los materiales a un centro de recogida RAEE
 Send the materials to a WEEE collection centre
 Envoyer les matériaux dans une déchetterie DEEE
 Inviare i materiali ad un centro di raccolta RAEE
 Die Materialien in einem WEEE-Zentrum entsorgen

