

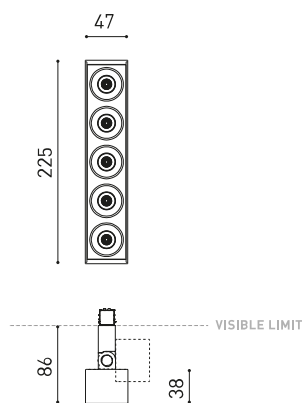

DIMENSIONS



ACCESSOIRES



TRACK 48V OPTIONS

Nom	BLACK FOSTER 48V TILT 5 SHORT SPOT 4000K NTMG
Référence	A4814112NTMG-S
Couleur	Noir Texturé-Or métallique
RAL	Finition métallique
Catégorie	TRACKLIGHTS

Type	LED
Flux lumineux brut	1250 lm
Température de couleur	4000 K
Stabilité chromatique	MacAdam Step 3
Indice de reproduction chromatique	CRI > 90
Puissance	10,5 W
Courant	700 mA
Efficacité	119 lm/W
Durée de vie de la LED	L90B10 > 102.000h

Efficacité lumineuse	90%
Angle du faisceau lumineux	19°

Driver	Inclus
Valeurs de puissance du système	11,72 W
Tension	48Vdc
Variation d'intensité	Non Dim
Classe d'isolation électrique	II

Étanchéité	IP20
Contrôle sans fil	Veillez consulter
Angle de basculement	90°
Angle de rotation	360°
Type de rail	Track 48V
Poids	450 g
Poids avec emballage	550 g
Dimensions de l'emballage	268 x 172 x 62 mm
Unités par emballage	1
Matériaux	Aluminium / Acrylonitrile Butadiène Styrène / Polycarbonate

PRODUIT

BLACK FOSTER 48V TILT 5 SHORT SPOT 4000K NTMG

A4814112NTMG-S

Noir Texturé-Or métallique

Finition métallique

TRACKLIGHTS

SOURCE DE LUMIÈRE

LED

1250 lm

4000 K

MacAdam Step 3

CRI > 90

10,5 W

700 mA

119 lm/W

L90B10 > 102.000h

LUMINAIRE | DONNÉES PHOTOMÉTRIQUES

90%

19°

LUMINAIRE | DONNÉES ÉLECTRIQUES

Inclus

11,72 W

48Vdc

Non Dim

II

D'AUTRES DONNÉES

IP20

Veillez consulter

90°

360°

Track 48V

450 g

550 g

268 x 172 x 62 mm

1

Aluminium / Acrylonitrile Butadiène Styrène / Polycarbonate

Le nouveau luminaire Black Foster 48V Tilt ajoute une nouvelle fonction pivotante au rail 48V. Il peut tourner sur son axe 360° et basculer 90°. Grâce à cette nouvelle fonction proposée, la lumière est projetée avec flexibilité, donnant lieu à des scènes séduisantes.

DIAGRAMME POLAIRE



DIAGRAMME CONIQUE

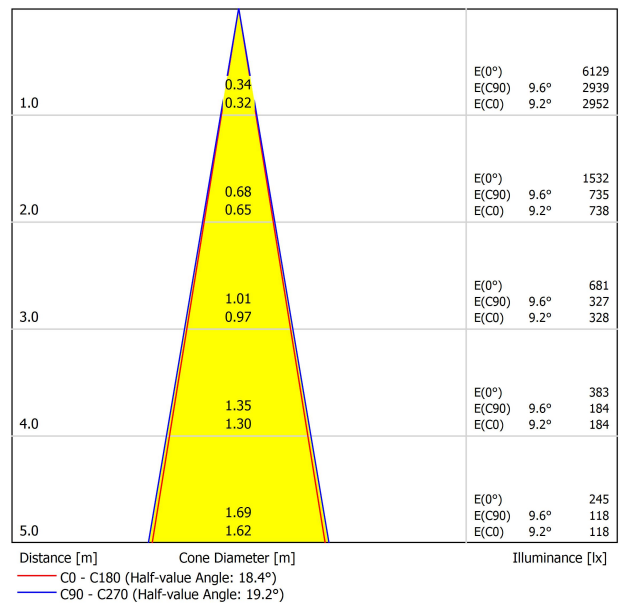

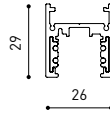

TRACK 48V SURFACE SHORT

Corner 90° One Plane



TRACK 48V SURFACE SHORT

TRACK 48V SURFACE SHORT 1m	A338-21-00- NT WT
TRACK 48V SURFACE SHORT 2m	A338-22-00- NT WT
TRACK 48V SURFACE SHORT 3m	A338-23-00- NT WT
TRACK 48V SURFACE SHORT Corner 90° One Plane	A338-24-00- NT WT



Electrical connection not included
Straight joiner included

	P	V	D
CONSTANT VOLTAGE LED POWER SUPPLY	0434-01-61 * N	100W	48V
	0434-01-62	150W	48V
			298 x 16 x 19 mm
			350 x 30 x 18 mm

220 V ~
240

*To be installed inside the track.



DROP VOLTAGE TABLE

POWER (W)	CABLE SECTION (mm ²)	CABLE LENGTH (m)			
		5	10	20	30
100	0,75	50	50	X	X
	1,5	50	50	40	25
150	0,75	40	15	X	X
	1,5	50	40	20	X

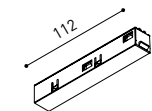
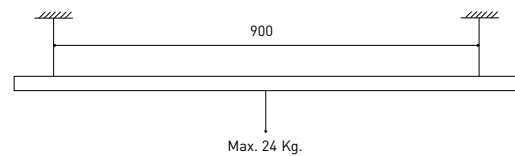

Live-End Connector 48V

A338-00-01- | W | N |

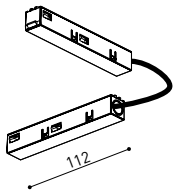

L-JOINT Connector 48V

A338-00-12- | W | N |

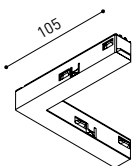

Corner 90° Connector One Plane 48V

A338-00-24- | W | N |

*Not suitable for trimless version

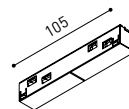

Central Connector 48V

A338-00-02- | W | N |

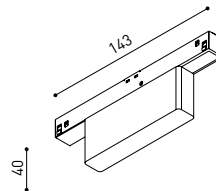

Wireless Control 48V

0434-01-31- | W | N | Casambi/AAG Stucchi App

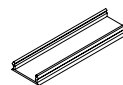

Cover Gap 1m 48V

0338-00-30- | W | N |

COLOUR | N ■ RAL 9005 | W □ RAL 9016 | NT ■ RAL 9005 | WT □ RAL 9016 |

SURFACE SHORT & SUSPENSION SHORT 48V



Short End 48V

A338-00-18- | NT | WT |



Short End feed 48V

A338-00-19- | NT | WT |



Straight Joiner 48V

A338-00-11

SURFACE SHORT 48V

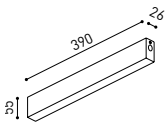

Power Supply Case 48V

A338-00-29- | NT | WT | 150 W

220 V ~ 240 V INCL *To be installed aside 48V Surface Tracks

SUSPENSION SHORT 48V



Wired Power Supply Case 48V

A338-00-25- | NT | WT | 150 W NO DIM

A338-00-26- | NT | WT | 150 W DIM

220 V ~ 240 V INCL



Suspension Kit 48V (2 units)

A338-00-15- | WT | NT |



Suspension Feed Kit 48V

A338-00-16- | W | N | NO DIM

A338-00-17- | W | N | DIM

*For remote power supply

A338-00-27- | W | N | NO DIM

A338-00-28- | W | N | DIM

*For power supply inside the track

WIRE TRIMLESS ACCESSORIES



FEED

MAINS TRIMLESS*

A023-00-01- | W | N | NO DIM

MAINS THICK TRIMLESS*

A023-00-02- | W | N | DIM

REMOTE INCL Ø20



FASTENING

STEEL CABLE TRIMLESS*

A023-00-05- | W | N |

INCL Ø20

MAINS TRIMLESS



MAINS THICK TRIMLESS



STEEL CABLE TRIMLESS



* AS MANY PIECES AS NEEDED ACCORDING TO YOUR PRODUCT

COLOUR | N ■ RAL 9005 | W □ RAL 9016 | NT ■ RAL 9005 | WT □ RAL 9016 |



Fuente de luz (LED) reemplazable por un profesional autorizado
 Replaceable (LED only) light source by an authorized professional.
 Source lumineuse (LED) remplaçable par un professionnel agréé
 Sorgente luminosa (LED) sostituibile da parte di un professionista autorizzato
 Austauschbare (LED) Lichtquelle durch einen autorisierten Fachmann



Equipo de control reemplazable por un profesional autorizado
 Replaceable control gear by an authorized professional
 Dispositif de commande remplaçable par un professionnel agréé
 Alimentatore sostituibile da parte di un professionista autorizzato
 Auswechselbares Betriebsgerät durch autorisierten Fachmann

INSTRUCCIONES PARA EL FINAL DE VIDA Y LA ELIMINACIÓN LOS COMPONENTES
 INSTRUCTIONS ON END-OF-LIFE AND COMPONENT DISPOSAL
 INSTRUCTIONS POUR LA GESTION DES COMPOSANTS EN FIN DE VIE ET LEUR MISE AU REBUT
 ISTRUZIONI PER IL FINE VITA E LO SMALTIMENTO DEI COMPONENTI
 ANWEISUNGEN ZUR ENTSORGUNG DER LEUCHTENKOMPONENTEN



Interrumpir la alimentación del aparato
 Cut the power supply to the luminaire
 Couper l'alimentation du luminaire
 Interrompere l'alimentazione dell'apparecchio
 Stromversorgung der Leuchte unterbrechen



Quitar la(s) fuente(s) de luz para el desecho
 Remove light source(s) for disposal
 Retirer la (les) source(s) lumineuse(s) pour l'élimination
 Rimuovere la/le sorgente/e di luce per lo smaltimento
 Lichtquelle(n) zur Entsorgung entfernen



Quitar la batería para el desecho
 Remove the battery for decommissioning
 Retirer la batterie pour sa mise au rebut
 Rimuovere la batteria per la dismissione
 Die Batterie ordnungsgemäß entsorgen



Quitar el equipo de control para el desecho
 Remove control gear for disposal
 Retirer le dispositif de commande pour l'élimination
 Rimuovere l'alimentatore per lo smaltimento
 Betriebsgerät zur Entsorgung ausbauen

Enviar los materiales a un centro de recogida RAEE
 Send the materials to a WEEE collection centre
 Envoyer les matériaux dans une déchetterie DEEE
 Inviare i materiali ad un centro di raccolta RAEE
 Die Materialien in einem WEEE-Zentrum entsorgen

