

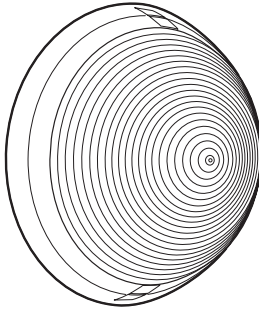







sarlam

SUPER 400

NT 37 086/08



			
 max	100 W		100 W
 max	53 W		
 max	17 W		
 max	9 W / 2 x 9 W / 16 W / 21 W		

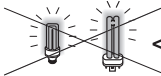

< 15 mm

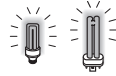

> 15 mm → OK

1 500xxx / 501xxx

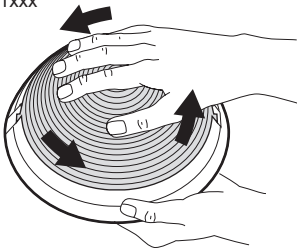

700xxx

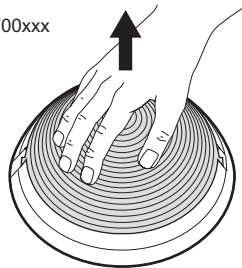

2

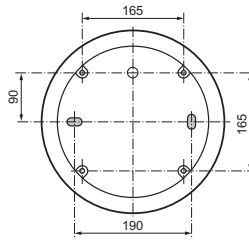
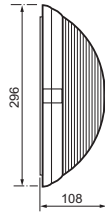

3

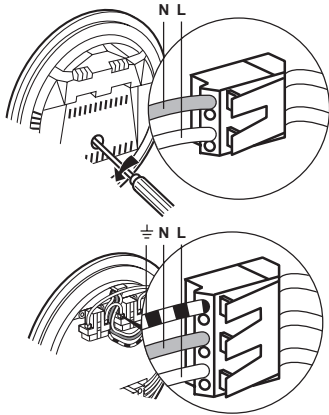
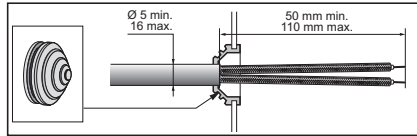
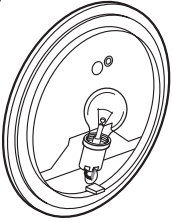

<input type="checkbox"/>	* Cl. I
L1 + N	⊕ + L1 + N
9W 2 X 9W	9W 2 X 9W 16W 21W

4

A 500xxx / 501xxx

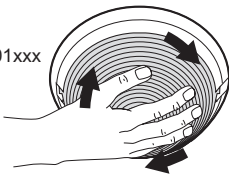

A 700xxx

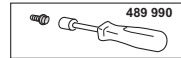
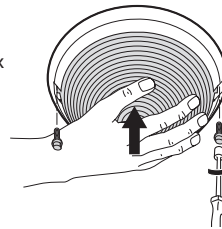

B

