



Rejilla para rebosadero

Desborda calidad

Swimming pool overflow grating

Overflowing with quality

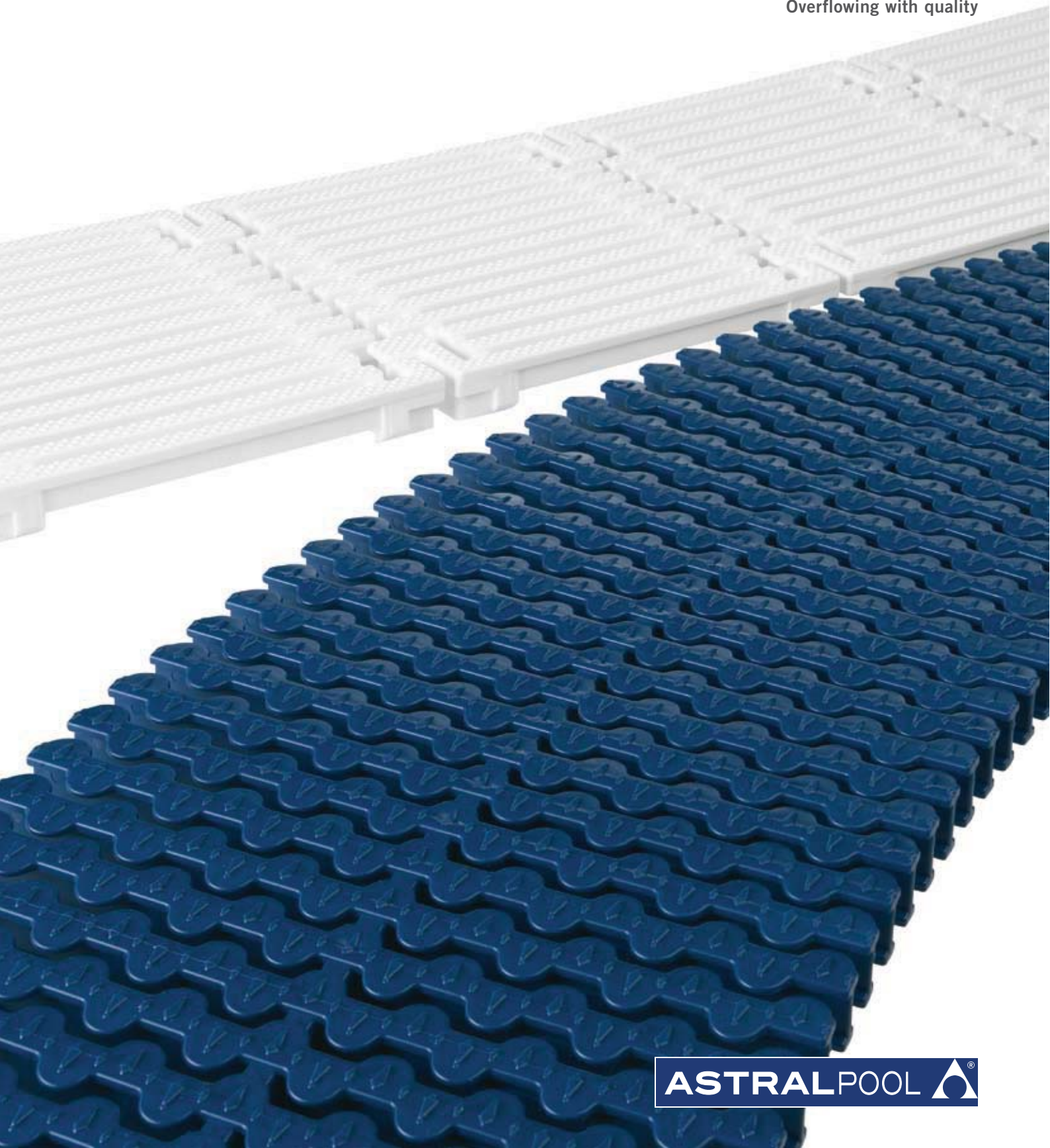

ASTRALPOOL 

Rejilla para rebosadero de piscina Swimming pool overflow grating

Dele el toque final a su piscina

AstralPool dispone de una amplia gama de rejillas, con diferentes y diversos sistemas de ensamblaje. Desde líneas rectas a ángulos de 45° - 90°, y curvas.

Las rejillas AstralPool están fabricadas en PP, resistente a la acción de los rayos U.V., con superficie antideslizante, de alta resistencia mecánica e inalterables a los agentes químicos y atmosféricos.

Formada por placas de módulos para tramos rectos o curvos (radio exterior de 1 ó 2 m), ensambladas entre sí por la unión clicada (macho-hembra), que permite cierta elasticidad de montaje, a la vez que absorbe posibles dilataciones, efecto de las diferencias térmicas a las que la rejilla se ve expuesta.

Para todos los modelos de rejilla es necesario construir el canal 5 mm más ancho que la rejilla, para que esta pueda adaptarse con facilidad y evitar posibles dilataciones.



Put the finishing touch to your pool.

AstralPool has a wide of range of gratings, with various assembly systems. From straight lines to 45° and 90° angles, and curves.

AstralPool gratings, manufactured in PP, are resistant to the action of UV rays, have an anti-slip surface and high mechanical resistance and cannot be altered by chemical and atmospheric agents.

Consisting of modular plates for straight or curved stretches (exterior radius of 1 or 2 m), with quickclick assembly (male-female),the assembly of the grating provides for certain elasticity as well as preventing possible expansions, an effect to which the grating is exposed.

For all models it is necessary to construct a channel 5 mm wider than the grating so that it fits comfortably and prevents possible expansions.

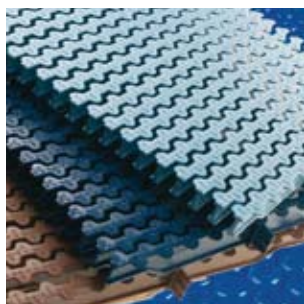

Seguridad

La nueva rejilla transversal para curvas 8 mm cumple con la normativa de seguridad EN-1345-1 y EN-1345-2.

Safety

The new grating tile for curves (8 mm) complies with the safety regulations EN-1345-1 and EN-1345-2.



Absorción

Gracias a la disposición longitudinal de las barras de la rejilla, paralelas al borde de la piscina, se evita el desbordamiento del oleaje.

Absorption

Thanks to the longitudinal positioning of the spines of the grating, parallel to the edge of the swimming pool, waves are totally absorbed.



Resistencia

Resistente a la acción de los rayos U.V., inalterables a los agentes químicos y atmosféricos. Absorbe posibles dilataciones, efecto de las diferencias térmicas a las que la rejilla se ve expuesta.

Resistance

Resistant to UV rays, the grating cannot be altered by chemical or atmospheric agents and possible expansion is absorbed.

Ancho canal (L) (mm) Channel width (L) (mm)	Ancho Rejilla (L _r) (mm) Grating width (L _r) (mm)
200	195
250	245
300	295
340	335
350	345

La altura de rejilla (h) varía según el modelo.

- Modelo longitudinal h = 24 mm y 22 mm.
- Modelo transversal h = 22 mm y 35 mm.

Height of grating (h) varies according to model.

- Longitudinal model h = 24 mm and 22 mm.
- Transversal model h = 22 mm and 35 mm.

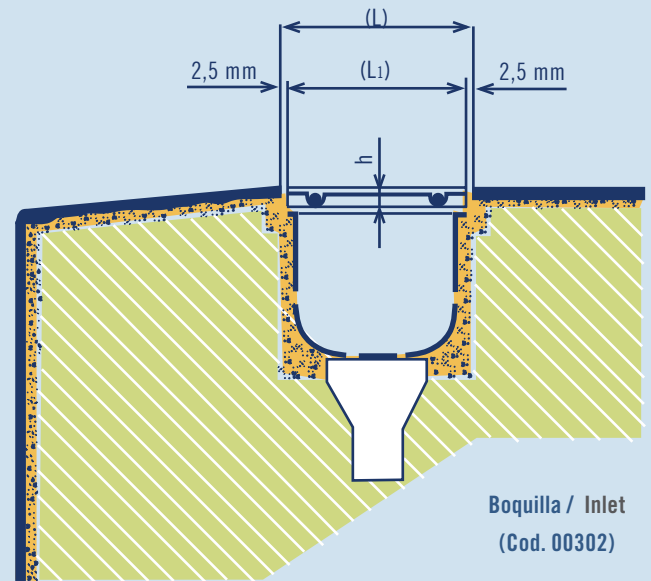

Modelo longitudinal Longitudinal grating

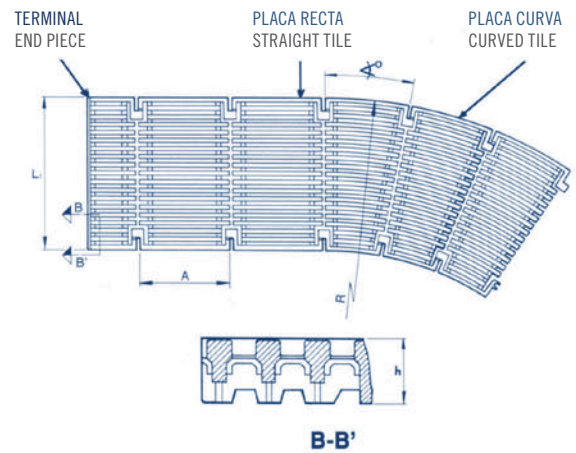
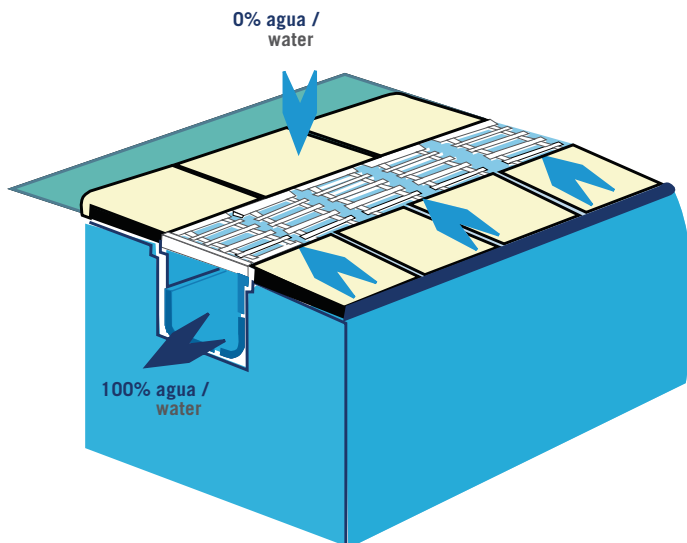

Rejilla longitudinal Longitudinal grating

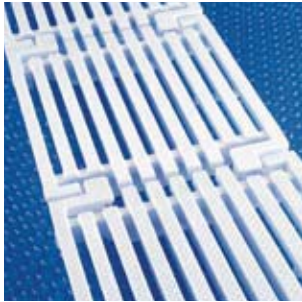

Placa rejilla longitudinal

Unión por anclajes macho-hembra de fácil y rápido montaje (5 unidades = 1024 m). La flexibilidad de sus unidades permite realizar radios de hasta 5 m. Certificada por la norma de seguridad EN-13451-1.

Código / Code	h (mm)	Ancho / Width (mm)
05581	24	195
05582	24	245
05583	24	295
05584	24	345

Longitudinal grating tile

For clicking together same types of male-female tiles (5 units = 1.024 m). The flexibility of these units allows for a radius of up to 5 m. Certified with EN-13451-1 safety standards.



Placa rejilla longitudinal curva

Unión en el sentido del montaje, por anclajes macho-hembra de fácil y rápida instalación. Permite combinaciones con piezas rectas. Certificada por la norma de seguridad EN-13451-1.

Cód. (1m) Code (1m)	Cód. (2m) Code (2m)	h (mm)	Ancho del canal (L) (mm) Channel width (L) (mm)	Ancho rejilla (L _r) (mm) Grating width (L _r) (mm)
08001	05585	24	200	195
07565	05586	24	250	245
08002	-	24	300	295
07566	-	24	350	345

Curved longitudinal grating tile

Made in PP, stabilised against UV rays. Click together in the same direction as the tiles. Can be combined with straight tiles. Certified with EN-13451-1 safety standards.

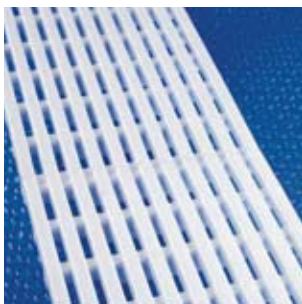

Placa rejilla longitudinal de 0,5 m.

Disponible en módulos de 500 mm de longitud unión por anclajes macho-hembra de fácil y rápido montaje. Certificada por la norma de seguridad EN-13451-1.

0.5 m. Longitudinal grating tile

It is available in 500 mm long modules with male-female fitting that is easy and quick to assemble. Certified with EN-13451-1 safety standards.

Código Code	h (mm)	Ancho rejilla (L _r) (mm) Grating width (L _r) (mm)
28664	22	195

La concepción longitudinal de este modelo asegura la asimilación completa de la lámina de agua, impidiendo que ésta pueda sortear los múltiples canales transversales que encuentra a su paso, conservando así, prácticamente seco el suelo que circunda a la piscina.

The longitudinal design of the tiles ensures that any excess water from the pool is not allowed to overflow onto the pool surround keeping this area dry.



Rejilla transversal Transversal grating



Rejilla transversal

Unión mediante cable. (49 unidades por m). Ver accesorios cable de acero y prisionero (ultima página).

Código Code	h (mm)	Ancho canal (L) (mm) Channel width (L) (mm)	Ancho rejilla (L _r) (mm) Grating width (L _r) (mm)
00212	22	200	195
00213	22	250	245

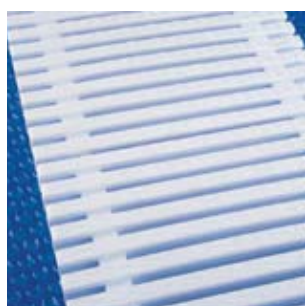

Placa rejilla transversal

Unión por anclajes macho-hembra de fácil y rápida instalación. (5 unidades = 0,975 m). Certificada por la norma de seguridad EN-13451-1

Código Code	h	Ancho canal (L) (mm) Channel width (L) (mm)	Ancho rejilla (L _r) (mm) Grating width (L _r) (mm)
00217	22	250	245
00218	22	300	295
00219	22	340	335

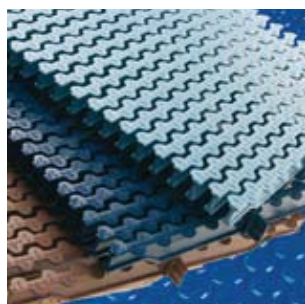

Rejilla transversal para curvas

Gama compuesta por 5 colores. Unión por acoplamiento de ajuste entre módulos. Certificada por la norma de seguridad EN-13451-1. Fabricadas en polipropileno para la protección contra los rayos UV. Módulos reversibles entre si en el modelo altura 35 mm. (52 unidades por m).



Bajo pedido, pueden realizarse rejillas de otros colores. Para más información, póngase en contacto con su distribuidor AstralPool. Other grating colours can be supplied on request. For further information, please contact your AstralPool distributor.

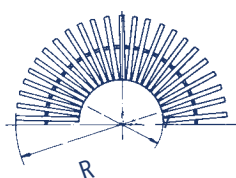
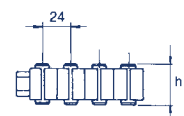

Código Code	h	Ancho canal (L) (mm) Channel width (L) (mm)	Ancho rejilla (L _r) (mm) Grating width (L _r) (mm)	R mm	r mm	Código Code	h	Ancho canal (L) (mm) Channel width (L) (mm)	Ancho rejilla (L _r) (mm) Grating width (L _r) (mm)	R mm	r mm
34190	22	200	195	645	450	34194	35	200	195	645	450
34191	22	250	245	825	580	34195	35	250	245	825	580
34192	22	300	295	1055	760	34196	35	300	295	1055	760
34193	22	340	335	1155	820	34197	35	340	335	1155	820

Transversal grating

Clicking with cable. (49 units per m). See the accessories: steel cable and brass locking. (last page)

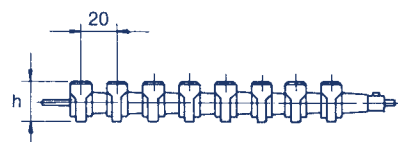

Transversal grating tile

Snaps together on central spine allowing for flexibility between tiles. (5 units = 0.975 m). Certified with EN-13451-1 safety standards

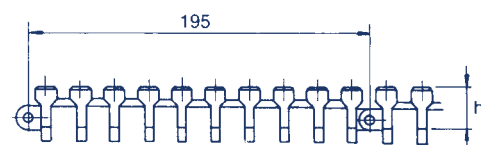

Transversal grating

The range is comprised of 5 colours. Module connection adjustment system. Certified with EN-13451-1 safety standards. Manufactured in polypropylene guaranteeing protection against UV rays. Modules are reversible in the 35 mm (height) model. (52 units per m).

Color Couleur	Código Code
Blanco standard / Standard white	-
Color marfil / Ivory - RAL 1015	CL90
Marrón oscuro / Dark brown - RAL 8002	CL109
Azul AstralPool / AstralPool blue - RAL 5003	CL60
Azul liner / Liner blue - RAL 5024	CL108

Placa rejilla transversal

Grating tile

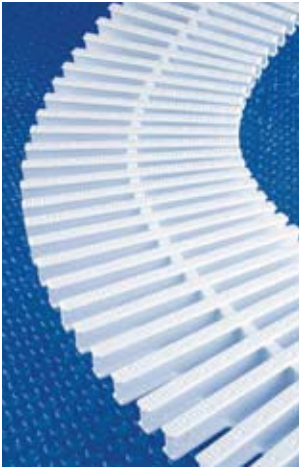

Rejilla transversal para curvas

Unión por anclajes macho-hembra de fácil y rápida instalación. (45 unidades por m.).

Código Code	h	Ancho canal (L) (mm) Channel width (L) (mm)	Ancho rejilla (L _r) (mm) Grating width (L _r) (mm)	R mm	r mm
11107	22	200	195	445	250
11108	22	250	245	545	300
19202	22	300	295	645	350
19203	22	340	335	785	450

Transversal grating for curves

Snaps together on central spine allowing for flexibility between tiles. (45 units per metre).

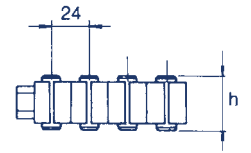

Rejilla transversal para curvas reversible

Reversible transversal grating for curves

Código Code	h	Ancho canal (L) (mm) Channel width (L) (mm)	Ancho rejilla (L _r) (mm) Grating width (L _r) (mm)	R mm	r mm
00220	35	200	195	445	250
00221	35	250	245	545	300
00222	35	300	295	645	350
00223	35	340	335	785	450

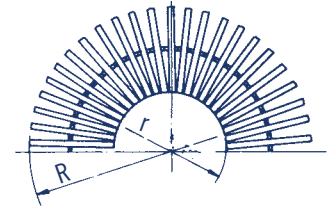

Placas para esquinas de canal rebosadero

Corner tiles for overflow channels

45 °

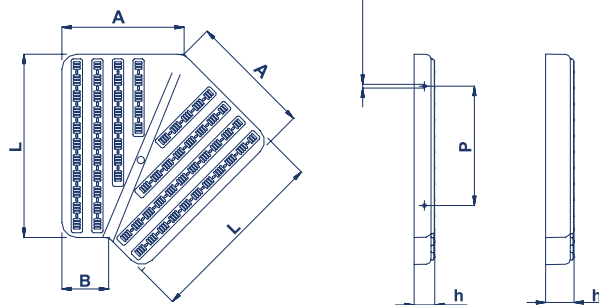
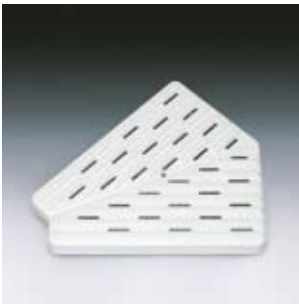

Código Code	A mm	B mm	h mm	L mm	P mm
22387	130	50	22	195	127
22388	150	50	22	245	127
22389	170	50	22	295	127
22390	190	50	22	335	127
22391	130	50	35	195	127
22392	150	50	35	245	127
22393	170	50	35	295	127
22394	190	50	35	335	127

90 °

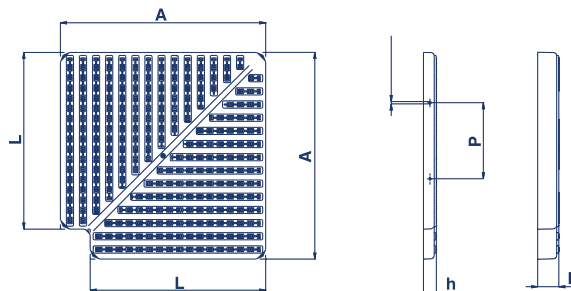

Código Code	A mm	h mm	L mm	P mm
22379	245	22	195	127
22380	295	22	245	127
22381	345	22	295	127
22382	385	22	335	127
22383	245	35	195	127
22384	295	35	245	127
22385	345	35	295	127
22386	385	35	335	127

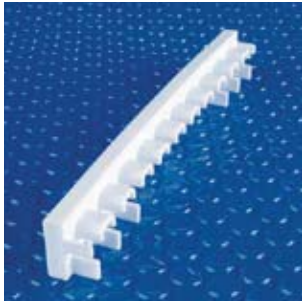

Terminal para placa rejilla longitudinal

Para adaptar a la última placa de cada longitud, en el caso de que fuera necesario cortar.

Código / Code	h mm	Ancho / Width mm
06420	24	195
06421	24	245
06422	24	295
06423	24	345



Kit terminal para placa rejilla longitudinal

Compuesto por placa en inox., terminal en polipropileno y rejilla longitudinal. Para adaptar a la última placa de cada longitud, en el caso de que fuera necesario cortar.

Código / Code	h mm	Ancho / Width mm
16064	24	195
16065	24	245
16066	24	295
16067	24	345

Cable de acero plastificado (Cód.00214).

Cable de acero inoxidable AISI-316 plastificado (Cód. 00215) ambos de Ø 2,5 mm, para unión de módulos.

Prisionero para cable fabricado en latón (Cód. 00216).

Perfil soporte placa rejilla

Adaptable a rejillas de 22, 24 y 35 mm de alto. En PP. Suministrado en tiras de 2m. Medidas interiores 24 mm x 37 mm. (Cód. 00224)



End piece for parallel tiles

To finish end tiles should cutting be necessary.

End piece kit for parallel grating corners

Comprising 1 finished half tile & 1 stainless steel grating profile. Used for the last piece of each length, should cutting be necessary.

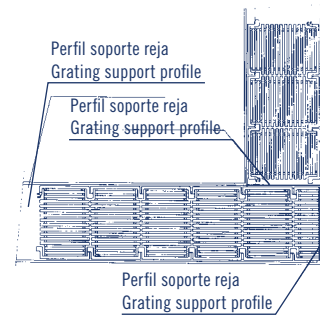

Plasticized steel cable (Cód.00214).

Stainless steel AISI-316 plasticized (Cod. 00215) To link straight modular grating 2.5 mm Ø.

Brass locking pins for cable (Cod. 00216).

Grating support profile

Suitable for 22, 24 and 35 mm high grating. Made in plastic. Supplied in 2 m lengths. Inside measurement 24 mm x 37 mm. (Cod. 00224)

Nos reservamos el derecho de cambiar total o parcialmente las características de nuestros artículos o el contenido de este documento sin previo aviso. We reserve the right to change all or part of the features of the articles or contents of this document, without prior notice.

