

► SKIMMER 17,5L PISCINA HORMIGÓN / SKIMMER 17,5L CONCRETE POOL



05280



11305

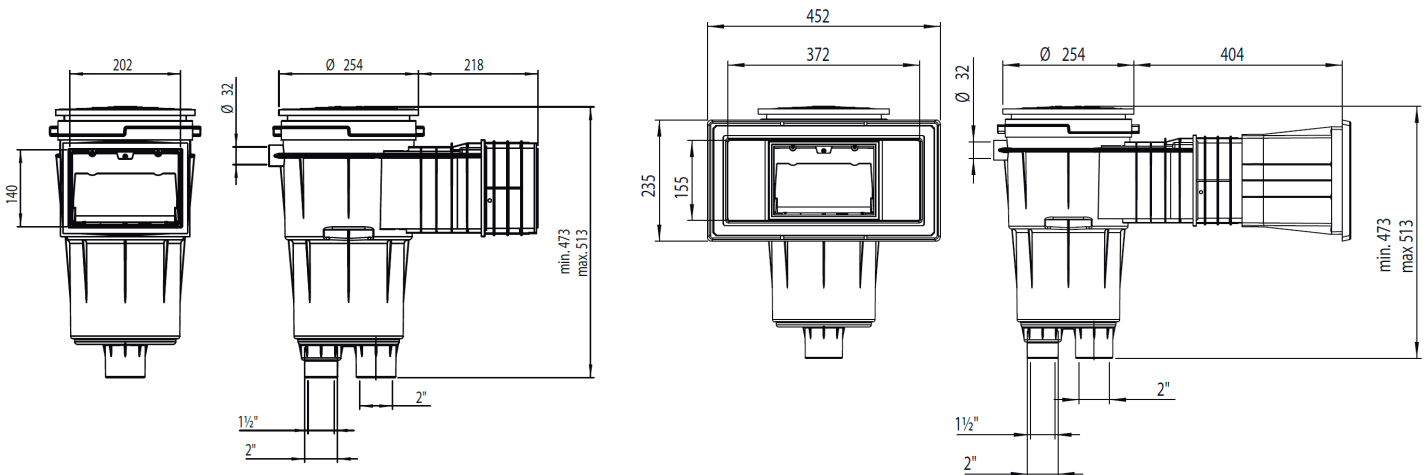





















DESCRIPCIÓN DEL PRODUCTO / PRODUCT DESCRIPTION

Suministrados con juntas adhesivas, bridas y tornillos. Todos los skimmers de la gama tienen tratamiento UV en las partes que no quedan enterradas. Fabricados en ABS blanco, con flotador de compuerta y tapón para regulación de caudal. Conexión inferior de aspiración: rosca interior 1 1/2", exterior 2". Conexión simultánea al sumidero: \varnothing interior 50. Conexión superior de evacuación de agua sobrante \varnothing 40. Cesto recogehojas fijado a la base mediante cierre por bayoneta. Caudal recomendado 7,5 m³/h. Se recomienda instalar un skimmer por cada 25 m² de superficie de lámina de agua.

Supplied with adhesive gaskets, flanges, and screw kit. All skimmer parts exposed are UV resistant. Recommended flow 7500 l/h. In white ABS with silent weir flap and flow regulation plug. 1 1/2" female – 2" male suction connections. \varnothing 50 mm. solvent connection also provided. Overflow connection \varnothing 40 mm. Basket secured to base with bayonet fixing.

► CARACTERÍSTICAS TÉCNICAS / TECHNICAL CHARACTERISTICS

CARACTERÍSTICAS CHARACTERISTICS	05280	11302	05281	11303	05282	11304	05283	11305	05589	11306
Tipo de boca <i>Type of throat</i>										
Forma tapa <i>Lid form</i>										
Alargo <i>Extended</i>	-	-	✓	✓	-	-	✓	✓	-	-
Embellecedor <i>Face plate</i>	✓	✓	✓	✓	✓	✓	✓	✓	-	-
Conexión superior <i>Top connection</i>	Ø 40									
Caudal recomendado <i>Recommended flow rate</i>	7,5 m ³ /h									
Superficie recomendada <i>Recommended surface</i>	cada 25 m ² every 25 m ²									

► LOGÍSTICA / LOGISTICS

EMBALAJE Y PALETIZADO / PALLETIZED AND PACKAGING

Código - Code	05280 - 05589 11302 - 11306			05281 - 11303			05282 - 11304			05283 - 11305		
Medidas caja (mm) - Box sizes (mm)	a	b	c	a	b	c	a	b	c	a	b	c
	300	480	430	300	480	530	460	600	490	470	700	490
Unidades / Caja - Units / Box	1			1			1			1		
Volumen / Caja (m ³) - Volume / Box (m ³)	0,062			0,076			0,135			0,16		
Peso / Caja (Kg) - Weight / Box (Kg)	5,12			6			6,2			6,75		
Medidas palet (mm) - Pallet sizes (mm)	a	b	c	a	b	c	a	b	c	a	b	c
	1000	1200	2300	1000	1200	2270	1000	1200	2070	1000	1200	2080
Unidades / Palet - Units / Pallet	35			28			16			12		
Volumen / Palet (m ³) - Volume / Pallet (m ³)	2,76			2,74			2,5			2,5		
Peso / Palet (Kg) - Weight / Pallet (Kg)	187,76			176,56			107,76			89,56		

► CAJA / BOX

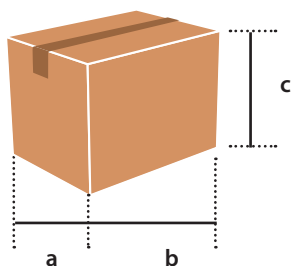

► PALET / PALLET

